

TOSVERT VF-S15 series

CANopen®

Communication Function Manual

NOTICE

1. Read this manual before installing or operating. Keep this instruction manual on hand of the end user, and make use of this manual in maintenance and inspection.
2. All information contained in this manual will be changed without notice. Please contact your Toshiba distributor to confirm the latest information.

Introduction

Thank you for purchasing TOSVERT VF-S15 series Inverter.

Before using CANopen[®] communication function, carefully read this function manual in order to completely and correctly utilize its excellent performance.

After reading this function manual, please keep it handy for future reference.

For details of its general handling, see an instruction manual attached with the option unit.



- TOSVERT VF-S15 Instruction Manual E6581611
- TOSVERT VF-S15 Communications Function Instruction Manual E6581913
- VF-S15 Option Adapter Instruction Manual E6581838

EDS file





Please contact your Toshiba distributor on EDS file.

* CANopen[®] and CiA are a registered trademark of CAN in Automation.

■ Handling in general

 Danger	
 Mandatory	<ul style="list-style-type: none"> ▼ Do not connect or disconnect a network cable while the Inverter power is on. It may lead to electric shocks or fire. ▼ See the instruction manual attached with the option unit for cautions the handling. Otherwise, it may lead to electric shocks, fire, injuries or damage to product.

■ Network control

 Danger	
 Prohibited	<ul style="list-style-type: none"> ▼ Do not send the value out of the valid range to network variables. Otherwise, the motor may suddenly start/stop and that may result in injuries.
 Mandatory	<ul style="list-style-type: none"> ▼ Use an additional safety device with your system to prevent a serious accident due to the network malfunctions. Usage without an additional safety device may cause an accident.
 Warning	
 Mandatory	<ul style="list-style-type: none"> ▼ Set up “Communication error trip function (see below)” to stop the Inverter when the network is deactivated by an unusual event such as tripping, an operating error, power outage, failure, etc. <ul style="list-style-type: none"> - Communication error trip time, Operation at communication error (Refer to “6.4 Communication disconnection detection function” for details) Deactivated the Inverter may cause an accident, if the “Communication error trip function” is not properly set up. ▼ Make sure that the operation signals are STOP before resetting Inverter’s fault. The motor may suddenly start and that may result in injuries.

■ Notes on operation

Notes	
	<ul style="list-style-type: none"> ▼ When the control power is shut off by the instantaneous power failure, communication will be unavailable for a while. ▼ The Life of EEPROM is approximately 100,000 times. Avoid writing a command more than 100,000 times to the same parameter of the Inverter and the communication board.

Table of Contents

1. Scope	4
1.1. Overview	4
2. Names and functions of main parts	4
2.1. Name of main parts	4
2.2. LED indicator (CiA 303-3)	5
2.3. CAN LED indicator	5
2.4. Command & Setpoint selection (Local/Remote)	6
2.5. Cable Specification	6
2.6. Network configuration	7
2.7. Bus cable length (CiA 303-1)	8
2.8. Example of SCAN time	9
3. Parameters	10
3.1. Command and Freq. Reference setting	10
3.2. Communication parameters	11
4. Communication Object	15
4.1. Communication Profile (DS 301)	15
4.1.1. Communication Profile (1000 to 11FFh)	15
4.1.2. SDO sever object	16
4.1.3. PDO object	17
4.1.4. RPDO object	17
4.1.5. TPDO object	19
4.2. Manufacturer specific profile	20
4.3. Device Profile (CiA 402)	21
5. Drive profile	22
5.1. Velocity mode object	22
5.1.1. Object 603Fh: Error Code	23
5.1.2. Object 6040h: Controlword	25
5.1.3. Object 6041: Statusword	27
5.1.4. Object 6042: vl_target_velocity	27
5.1.5. Object 6043h: vl_velocity_demand	27
5.1.6. Object 6044: vl_velocity_actual_value	27
5.1.7. Object 6046: vl_velocity_min_max_amount	28
5.1.8. Object 6048h: vl_velocity_acceleration	28
5.1.9. Object 6049: vl_velocity_deceleration	28
5.1.10. Object 604A: vl_velocity_quick_stop	28
5.1.11. Object 605A: Quick stop option code	28
5.1.12. Object 6060: Modes of operation	29
5.1.13. Object 6061: Modes of operation display	29
5.1.14. Object 6502: Supported drive mode	29
6. Control from CANopen Network	30
6.1. NMT state machine	30
6.2. SDO communication	30
6.2.1. Read object (Upload object)	31
6.2.2. Write object (Download object)	31
6.2.3. Abort code	32
6.3. PDO communication	33
6.3.1. TxPDO and RxPDO communication type	33
6.3.2. RTR (Remote Transfer Request) communication	34
6.3.3. SYNC communication	34
6.3.4. Emergency object	34
6.4. Communication disconnection detection function	35
6.4.1. Heartbeat Consumer	35
6.4.2. Heartbeat producer	35
6.4.3. Node Guarding	35
6.4.4. NMT Boot-up	36

7. Example communication.....	37
7.1. Asynchronous communication.....	37
7.2. SYNC communication	39
8. Specifications.....	41
8.1. Data and operating specification.....	41
8.2. CANopen device specification	41
8.3. Connecting of CANopen communication option	42

1. Scope

1.1. Overview

Thank you for purchasing TOSVERT VF-S15 inverter. VF-S15 can connect with open field network CANopen® network and data communications with the VF-S15 CANopen® option supports up to 64 nodes for one segment.

By using CANopen® function, the monitor of run/stop and the setting change of the parameter become possible from the network, and it can cope with various applications.

This manual is also aimed at the operator using "VF-S15", so please use it for future maintenance and inspection.

2. Names and functions of main parts

2.1. Name of main parts

CAN open LED indicator
 GREEN : CAN RUN
 RED : CAN ERR

Refer to E6581838 about VF-S15
 Option adapter (SBP009Z)

Connection type

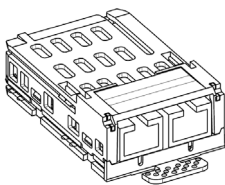

Type form	CAN001Z
Connector	2 × RJ45

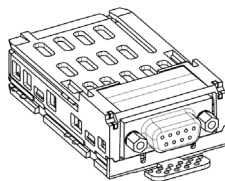

Type form	CAN002Z
Connector	9pin D-sub

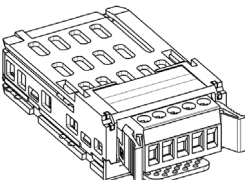

Type form	CAN003Z
Connector	5 pin open type

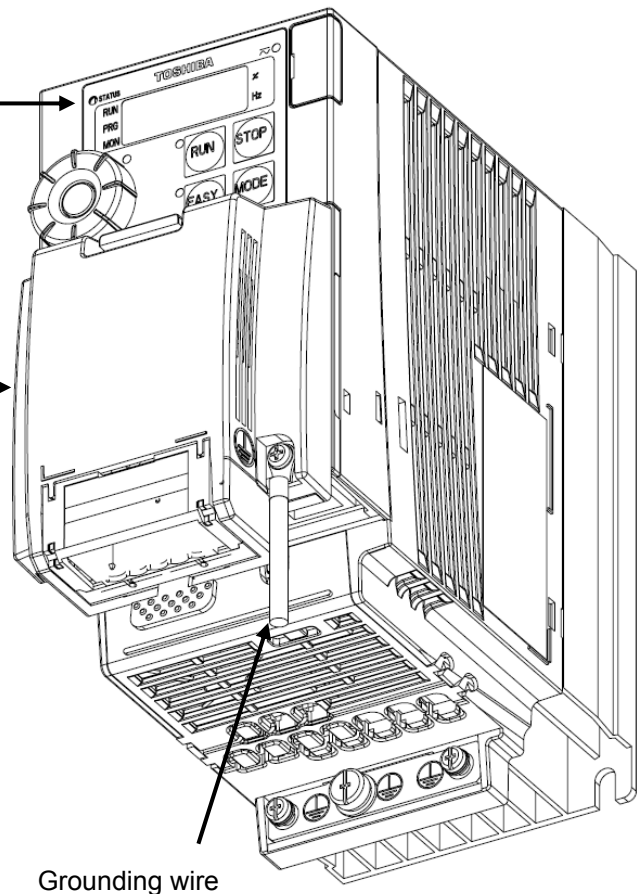

2.2. LED indicator (CiA 303-3)

CAN LED indicate CANopen® communication Status and Error condition.

2.3. CAN LED indicator

RUN status LED display. Those functions are below table.

CAN RUN Status Green LED CAN ERR Status Red LED	State	Description
<p>Blinking</p>	PRE-OPERATIONAL	The device is in state PRE-OPERATIONAL
<p>Single flash</p>	STOPPED	The device is in state STOPPED
<p>RUN : On ERR : Off</p>	OPERATIONAL	The device is in state OPERATIONAL

ERR status LED display. Those functions are below table.

CAN RUN Status Green LED CAN ERR Status Red LED	State	Description
<p>RUN : --- ERR : Off</p>	No Error	The device is in working condition
<p>Single flash</p>	Warning limit reached	At least one of the error counters of the CAN controller has reached or exceeded the warning level (too many error frames)
<p>Double flash</p>	Error control event	A guard event (NMT-slave or NMT-master) or a heartbeat event (heartbeat consumer) has occurred
<p>RUN : --- ERR : On</p>	Bus off	The CAN controller is bus off

2.4. Command & Setpoint selection (Local/Remote)

CANopen® communication command and setpoint are activated on Remote mode.

Inverters have some switches to select the command and setpoint location. Following figure shows the diagram. Refer to the inverter instruction manual for the parameter in detail.

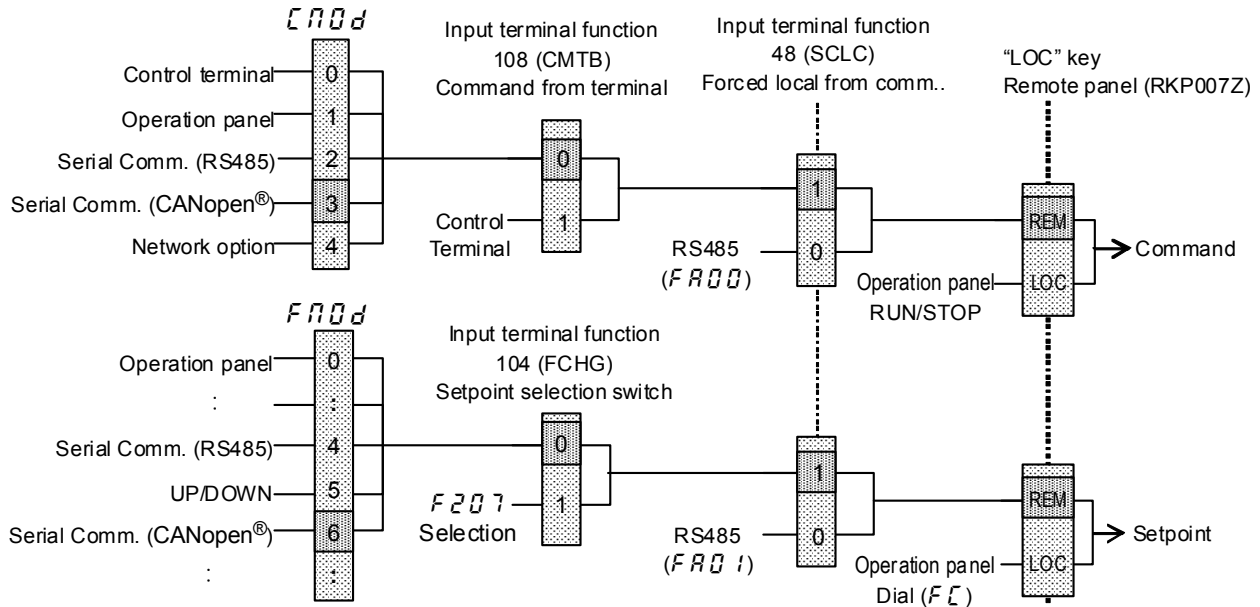

2.5. Cable Specification

Recommended cable specification is below

AC parameters : 120 ohm impedance and 5ns/m specific line delay

Selected recommended cable is below.

Manufacture : NIHON ELECTRIC WIRE & CABLE Co., LTD.

www.nihondensen.co.jp

Distributor : Showa Denki Co., Ltd.

www.showa-dk.co.jp

Model No.	CANC-22
Conductor size	24 AWG, 0.22mm ²
Number of pairs	2 (Blue/White, Yellow/ Green)
Conductor resistance at 20 Centigrade	less than 88.0 ohm/km
Capacitance	less than 60nF/km (1kHz)
Characteristic impedance	120 ohm +/-10% (1MHz)
Delay	5 ns typ. (1MHz)
Overall dia. Approx.	8.5mm
UL style No.	UL 2704
Weight	75kg/km

* Fix a cable so that a communication connector may be not taken the weight of wire.

2.6. Network configuration

Make up the network as follows.

- Transmission/reception signals (CAN_H, CAN_L)

Make up the communication path by connecting twisted cables with shield.

- Signal common (CAN_GND)

GND is the signal common.

- Grounding the shield of cable (CAN_SHLD)

Connect the all shield lines of network cable. The shield shall be grounded at one end only prevent currents from being created.

- Termination resistor

A termination resistance of 120 ohms plus or minus 5% shall be connected at each of the two ends of the segment medium.

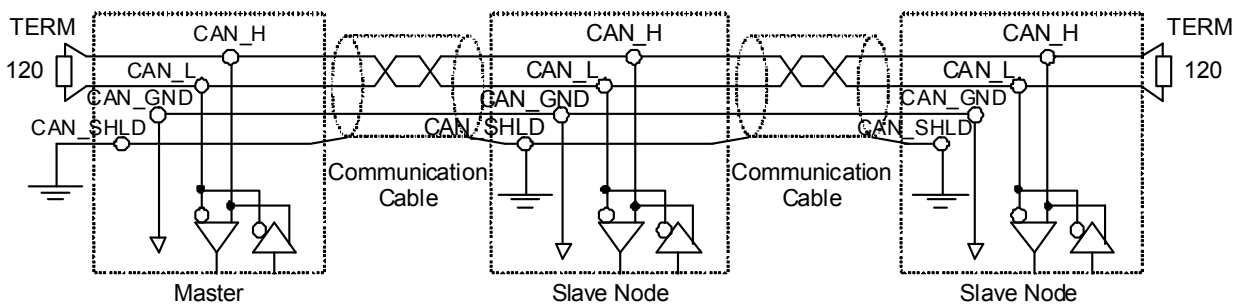

N.B.:RJ45 connector shield case is connected to the drive frame grounded in the drive.

Keep the network cables 20cm or more separate from the power cables to prevent from malfunctioning due to electromagnetic noise.

2.7. Bus cable length (CiA 303-1)

Bus cable length depends on the below items.

- a) Number of the slave
- b) Cable type
- c) Bit rate

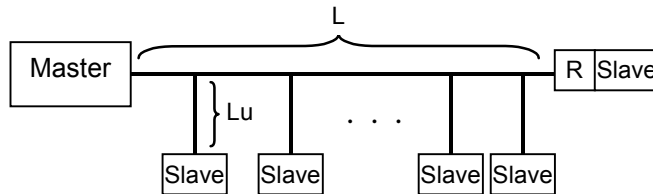

AC parameters : 120 ohm impedance and 5ns/m specific line delay

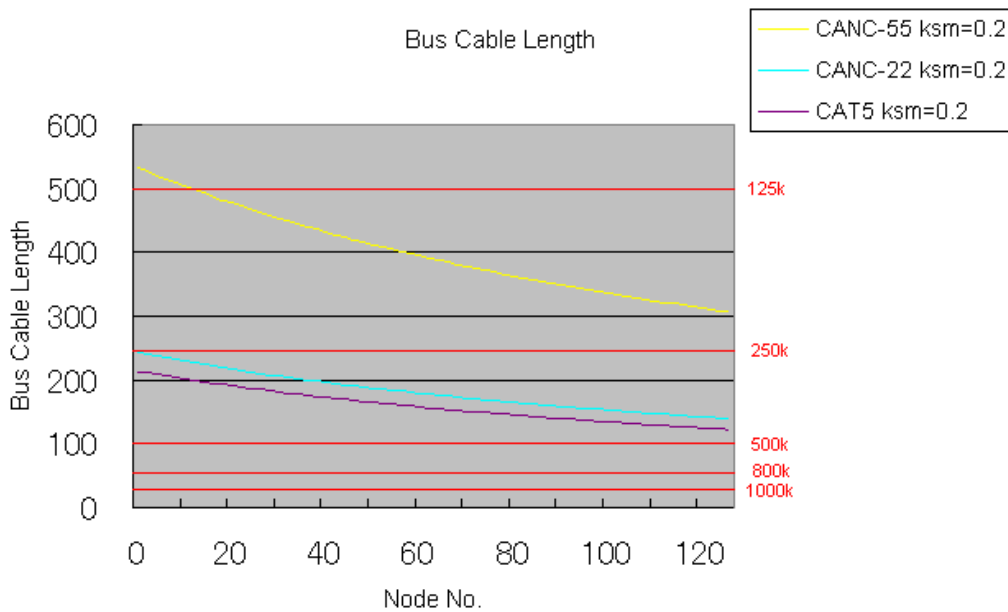

Number of Node and Bit rate.

Bit rate	Number of node						Lu max	Σ Lu
	20	40	60	80	100	120		
1M	25m						1.5m	5m
800k	50m						2.5m	7.5m
500k	100m						5m	25m
250k							10m	50m
125k							20m	100m
50k	219m (193m)	198m (174m)	181m (159m)	160m (146m)	154m (135m)	143m (126m)	60m	350m
20k							150m *1	750m
10k							300m *1	1500m

CANC-22 (CAT5) cable

*1: Limited by Number of node

2.8. Example of SCAN time

Below table is the recommended scan time depend on the number of the drive and the baud rate.

1 unit : Tx 8byte(4word) / Rx 8byte(4word) ··· total 129bit (include stub 5 bits)

Delay : 3.5ms

Margin : 80%

		SCAN time (ms)				
Drive Unit No. bps	8	16	32	48	64	
1M	7	9	14	19	25	
800k	7	10	17	23	30	
500k	9	14	25	35	45	
250k	14	25	45	66	87	
125k	25	45	87	128	169	
50k	56	107	210	314	417	
20k	133	262	520	778	1036	
10k	262	520	1036	1552	2068	

$$\text{Time} = (\text{No of bit}) \times (\text{No of Drive unit}) \times (\text{No. of PDO}) / (\text{baud rate}) / (\text{margin}) + \text{delay} + @$$

Ex. 1Mbps, 1TPDO, 1RPDO, 80%, 3.5ms delay

$$\begin{aligned} \text{Time} &= 129\text{bit} \times 64\text{unit} \times 2\text{PDO} / (1\text{e}6) / (80\%/100) + 3.5\text{ms} + @ \\ &= 25\text{ms} \end{aligned}$$

3. Parameters

3.1. Command and Freq. Reference setting

Set up the inverter parameters as follows when command via CiA 402 profile. From CANopen network, the drive parameters can be commanded directory. The latest commanded parameters are activated when same run command / frequency reference command.

Refer to the below table and the figure and the capture “2.4 Command & Setpoint selection (Local/Remote)”.

P No.	Parameter function	Default Value	Note
<i>CNOd</i>	Command mode selection	1	3: CANopen communication
<i>FNOd</i>	Frequency setting mode selection 1	0	6: CANopen communication

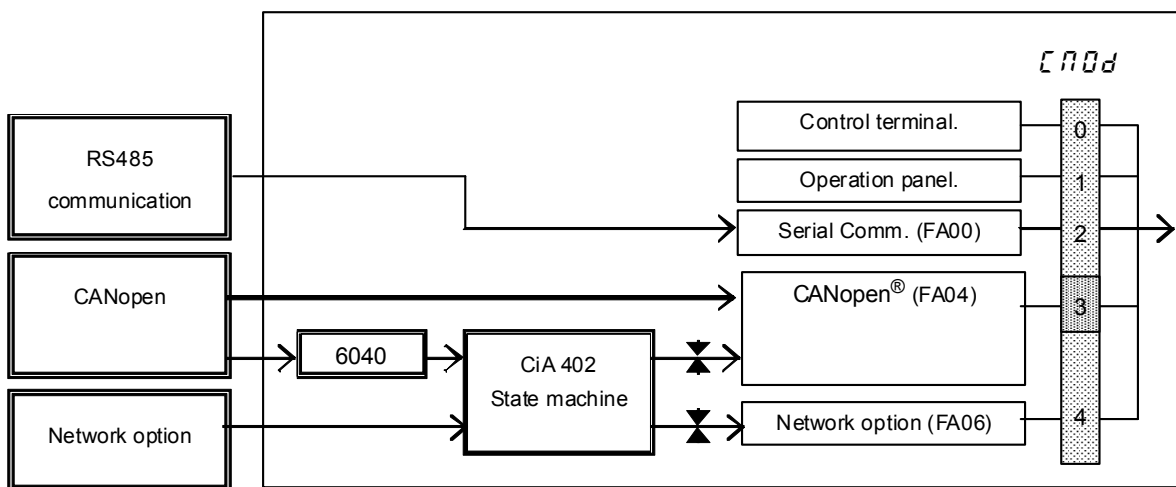

Figure 1 Command source

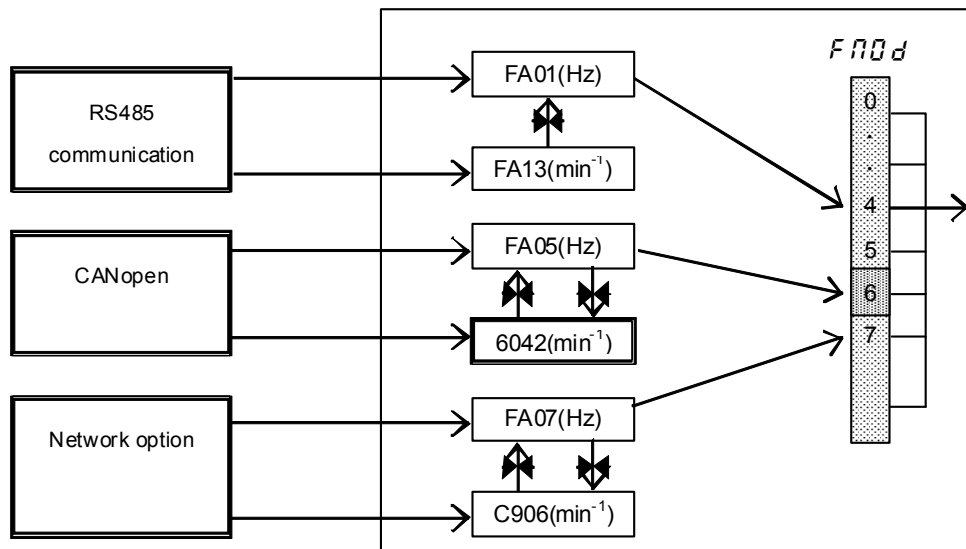

Figure 2 Frequency reference command source

3.2. Communication parameters

P No.	Parameter function	Default Value	Note
<i>F856</i>	Number of motor poles for communication	2	2: 4 pole
<i>F898</i>	Inverter reset mode selection	0	0: Terminal board, Panel keypad or FA00 reset command rests the drive. CANopen (CiA 402, FA04) and COM option (CiA 402, FA06) reset command only reset fault condition. 1: All reset command reset the drive. 2: -
<i>F899</i>	Communication function reset	0	0: - 1: Reset (after execution: 0)

P No.	Parameter function	Default Value	Note
<i>C100</i>	Communication time out	0.0	0.0 to 100.0 sec
<i>C101</i>	Inverter operation at the communications loss action (Guard Time, Heartbeat)	4	0: Stop and Communication release (follows <i>C100</i> and <i>F100</i> setting) (Do not set at Software is Ver. 1.00.) 1: None 2: Deceleration stop 3: Coast stop 4: Emergency stop 5: Preset speed operation command (Operating at the preset speed operation frequency set with <i>C102</i>)
<i>C102</i>	Preset speed operation selection	0	0: None 1 to 15: Preset speed
<i>C103</i>	Communication time-out condition selection	1	0: Disconnection detection 1: When communication mode enable (Both <i>C100</i> and <i>F100</i> are set CANopen or COM option) 2: 1+Driving operation
<i>C104</i>	Node ID	0	0 : Disable CANopen 1 ~ 127 : Node ID
<i>C102</i>	Baud rate 0: 20k 4: 500k 1: 50k 5: 800k 2: 125k 6: 1M 3: 250k	2 (125kbps)	CAN communication baud rate
<i>C103</i>	SYNC message COB-ID	0x0080	#1005 Set Lower word
<i>C104</i>	Guard Time:	0	#100C 1ms unit
<i>C105</i>	Life Time Factor:	0	#100D from 0 to 255
<i>C106</i>	Node-ID of Heartbeat Producer	0x0000	#1016 Bits 16-23 = Node-ID of Heartbeat Producer Bits 24-31 = Reserved (00)
<i>C107</i>	Max. duration of Consumer Heartbeat	0x0000	#1016 Bits 00-15 = Max. duration of Consumer Heartbeat (unit = 1 ms) Note: A single Heartbeat Producer can be configured here. By default, no producers are monitored (value = 0).
<i>C108</i>	Producer Heartbeat Time:	0	#1017 1ms unit

C711	PDO1	Receive: COB-ID entry High word	0x00000200	#1400 subidx 01 If the setting is default setting, COB-ID is below value. COB-ID=0x00000200+Node-
C712		Low word		
C713		RPDO transmission type	0x0FF	#1400 subidx 02 Asynchronous
C714		Transmit :COB-ID High word	0x00000180	#1800 subidx 01 If the setting is default setting, COB-ID is below value. COB-ID=0x00000180+Node-ID
C715		Low word		
C716		TPDO Transition type	0x0FF	#1800 subidx 02 Asynchronous
C717		Transmit Inhibit time:	100	#1800 subidx 03 unit=100us, min 2ms
---		Transmit Reserved	---	#1800 subidx 04
C719		Transmit Event timer:	0	#1800 subidx 05 unit=1ms, min 10ms
C721	PDO2	Receive: COB-ID entry High word	0x80000300	#1401 subidx 01 If the setting except bit31 is 0x00000300, use the default setting except bit31 0x00000300+Node-ID for #1401 subidx 01.
C722		Low word		
C723		RPDO transmission type	0x0FF	#1401 subidx 02 Asynchronous
C724		Transmit :COB-ID High word	0x80000280	#1801 subidx 01 If the setting except bit31 is 0x00000280, use the default setting except bit31 0x00000280+Node-ID for #1801 subidx 01.
C725		Low word		
C726		TPDO Transition type	0x0FF	#1801 subidx 02 Asynchronous
C727		Transmit Inhibit time:	100	#1801 subidx 03 unit=100us, min 2ms
---		Transmit Reserved	---	#1801 subidx 04
C729		Transmit Event timer:	0	#1801 subidx 05 unit=1ms, min 10ms
C731	PDO3	Receive: COB-ID entry High word	0x80000400	#1402 subidx 01 If the setting except bit31 is 0x00000400, use the default setting except bit31 0x00000400+Node-ID for #1402 subidx 01.
C732		Low word		
C733		RPDO transmission type	0x0FF	#1402 subidx 02 Asynchronous
C734		Transmit :COB-ID High word	0x80000380	#1802 subidx 01 If the setting except bit31 is 0x00000380, use the default setting except bit31 0x00000380+Node-ID for #1802 subidx 01.
C735		Low word		
C736		TPDO Transition type	0x0FF	#1802 subidx 02 Asynchronous
C737		Transmit Inhibit time:	100	#1802 subidx 03 unit=100us, min 2ms
---		Transmit Reserved	---	#1802 subidx 04
C739		Transmit Event timer:	0	#1802 subidx 05 unit=1ms, min 10ms
C741	PDO21	Receive: COB-ID entry High word	0x80000500	#1414 subidx 01 If the setting except bit31 is 0x00000500, use the default setting except bit31 0x00000500+Node-ID for #1414 subidx 01.
C742		Low word		
C743		RPDO transmission type	0x0FF	#1414 subidx 02 Asynchronous
C744		Transmit :COB-ID High word	0x80000480	#1814 subidx 01 If the setting except bit31 is 0x00000480, use the default setting except bit31 0x00000480+Node-ID for #1814 subidx 01.
C745		Low word		
C746		TPDO Transition type	0x0FF	#1814 subidx 02 Asynchronous
C747		Transmit Inhibit time:	100	#1814 subidx 03 unit=100us, min 2ms
---		Transmit Reserved	---	#1814 subidx 04
C749		Transmit Event timer:	0	#1814 subidx 05 unit=1ms, min 10ms

P No.	Parameter function	Default Value	Note	
C 750	PDO1	Number of command objects	0x02	#1600 subidx 00 Receive PDO1 assignment: Number of objects assigned
C 751		Command 1	0x6040	#1600 subidx 01 Command Index No. 0x6040: Controlword
C 752		Command 2	0x6042	#1600 subidx 02 Command Index No. 0x6042: vl target velocity
C 753		Command 3	0x0000	#1600 subidx 03 Command Index No.
C 754		Command 4	0x0000	#1600 subidx 04 Command Index No.
C 755		Number of monitor objects	0x02	#1A00 subidx 00 Transmit PDO1 assignment: Number of objects assigned
C 756		Monitor 1	0x6041	#1A00 subidx 01 Monitor Index No. 0x6041: vl Statusword
C 757		Monitor 2	0x6044	#1A00 subidx 02 Monitor Index No. 0x6044: vl velocity actual value
C 758		Monitor 3	0x0000	#1A00 subidx 03 Monitor Index No.
C 759		Monitor 4	0x0000	#1A00 subidx 04 Monitor Index No.
C 760	PDO2	Number of command objects	0x01	#1601 subidx 00 Receive PDO2 assignment: Number of objects assigned
C 761		Command 1	0x6040	#1601 subidx 01 Command Index No.
C 762		Command 2	0x0000	#1601 subidx 02 Command Index No.
C 763		Command 3	0x0000	#1601 subidx 03 Command Index No.
C 764		Command 4	0x0000	#1601 subidx 04 Command Index No.
C 765		Number of monitor objects	0x01	#1A01 subidx 00 Transmit PDO2 assignment: Number of objects assigned
C 766		Monitor 1	0x6041	#1A01 subidx 01 Monitor Index No.
C 767		Monitor 2	0x0000	#1A01 subidx 02 Monitor Index No.
C 768		Monitor 3	0x0000	#1A01 subidx 03 Monitor Index No.
C 769		Monitor 4	0x0000	#1A01 subidx 04 Monitor Index No.
C 770	PDO3	Number of command objects	0x01	#1602 subidx 00 Receive PDO3 assignment: Number of objects assigned
C 771		Command 1	0x6040	#1602 subidx 01 Command Index No.
C 772		Command 2	0x0000	#1602 subidx 02 Command Index No.
C 773		Command 3	0x0000	#1602 subidx 03 Command Index No.
C 774		Command 4	0x0000	#1602 subidx 04 Command Index No.
C 775		Number of monitor objects	0x01	#1A02 subidx 00 Transmit PDO3 assignment: Number of objects assigned
C 776		Monitor 1	0x6041	#1A02 subidx 01 Monitor Index No.
C 777		Monitor 2	0x0000	#1A02 subidx 02 Monitor Index No.
C 778		Monitor 3	0x0000	#1A02 subidx 03 Monitor Index No.
C 779		Monitor 4	0x0000	#1A02 subidx 04 Monitor Index No.
C 780	PDO21	Number of command objects	0x01	#1614 subidx 00 Receive PDO21 assignment: Number of objects assigned
C 781		Command 1	0x6040	#1614 subidx 01 Command Index No.
C 782		Command 2	0x0000	#1614 subidx 02 Command Index No.
C 783		Command 3	0x0000	#1614 subidx 03 Command Index No.
C 784		Command 4	0x0000	#1614 subidx 04 Command Index No.
C 785		Number of monitor objects	0x01	#1A14 subidx 00 Transmit PDO21 assignment: Number of objects assigned
C 786		Monitor 1	0x6041	#1A14 subidx 01 Monitor Index No.
C 787		Monitor 2	0x0000	#1A14 subidx 02 Monitor Index No.
C 788		Monitor 3	0x0000	#1A14 subidx 03 Monitor Index No.
C 789		Monitor 4	0x0000	#1A14 subidx 04 Monitor Index No.

 **Warning**



Mandatory
action

- ▼ Set up “Communication error trip function (C 100 ~ C 103)” to stop the inverter when CANopen communication is deactivated.
- ▼ When CANopen state is “OPERATIONAL”, the CANopen communication parameters can not be changed. Set the CANopen state to “PRE-OPERATIONAL.”
- ▼ When the parameters are changed, the power must be cycled to the VF-S15 for the changes to take effect.

4. Communication Object

Object Dictionary has mainly 3 object set.

- Communication Profile Area (Index 1000 to 1FFFh)
- Manufacturer Specific Profile Area (Index 2000 to 5FFFh)
- Standard Device Profile Area (Index 6000 to 9FFFh)

4.1. Communication Profile (DS 301)

4.1.1. Communication Profile (1000 to 11FFh)

These object are CANopen communication configuration settings for example Node-ID etc.. These communication profile object can not be mapped into PDO.

Index (Hex)	Sub index	Access	Type	Default value	Description
1000	00	RO	u32	0x00010192	Device type Bits 24-31 not used (0), Bits 16-23 = Type of device (1) Bits 0-15 = Device profile number (402)
1001	00	RO	u8	0x00	Error register : Error (= 1) or no error (= 0) Bit0: Generic Bit4: Communication Bit1: Current Bit5: Device profile specific Bit2: Voltage Bit6: reserved(=0) Bit3: Temperature Bit7: Manufacturer specific
1003	00	RO	u8	0x01	Number of errors: Only one possible error (1), located in object #1003 sub 01
	01	RO	u32	0x00000000	Standard error field: Bits 16-31 = Additional information (always 0) Bits 00-15 = Error code parameter
1005	00	R/W	u32	0x00000080	COB-ID entry for SYNC message Bit 30=0: Device does not generate SYNC message. (Fixed) Bit 29=0: 11bit CAN-ID valid. (Fixed) Bit 0-10: 11bit SYNC COB-ID
1008	00	RO	string	VF-S15	Manufacturer device name
100A	00	RO	string	1.00	Manufacturer software version Application software version VF-S15: parameter <i>F E D B</i>
100C	00	R/W	u16	0x0000	Guard Time: By default, the Node Guarding protocol is deactivated (0); the unit for this object is 1 ms. If use this protocol (Guard Time > 0), make sure that the Heartbeat protocol is deactivated on the drive (Object 1017: Producer Heartbeat Time > 0). When not receive the Remote frame message in term of this, the drive generate the Network disconnect error.
100D	00	R/W	u8	0x00	Life Time Factor: Multiplier coefficient applied to the Guard Time to obtain the Life Time. The value 0 deactivates the Node Guarding service in respect of the drive.

1010	00	RO	u8	0x01	Save all parameter – Number of entries
	01	R/W	U32	0x00000003	Save all parameter: Set 'e','v','a','s' (0x65, 0x76, 0x61, 0x73) to this sub-index, from [700 to [789 and Object 60xx parameters data are store to EEPROM.
1011	00	RO	u8	0x01	Restore default parameter – Number of entries
	01	R/W	U32	0x00000001	Restore default parameter: Set 'd','a','o','l' (0x64, 0x61, 0x6f, 0x6c) to this sub-index, from [703 to [789 and Object 60xx parameters data are restore to factory setting data. Restore data are available after power On/Off reset or Rest command from Network.
1014	00	RO	u32	0x00000080 +Node-ID	COB-ID Emergency message: (EMCY) Bit 31=0: EMCY exist / is valid. Bit 30 : Reserved Bit 29=0 : frame is 11bit-CAN-ID valid = 1 bit 0-10: 11bit CAN-ID of the CAN base frame.
1016	00	RO	u8	0x01	Consumer Heartbeat Time – Number of entries
	01	R/W	u32	0x00000000	Bits 24-31 = Resaved (00) Bits 16-23 = Node-ID of Heartbeat Producer Bits 00-15 = Max. duration of Consumer Heartbeat (unit = 1 ms) Note: A single Heartbeat Producer can be configured here. By default, no producers are monitored (value = 0). When not receive the Heartbeat message in term of this, the drive generate the Network disconnect error.
1017	00	R/W	u16	0x0000	Producer Heartbeat Time: Heartbeat messages; the unit of this object is 1 ms. If you use this protocol (Producer Heartbeat Time > 0), make sure that the Node Guarding protocol is deactivated on the drive (Guard Time = 0).
1018	00	RO	u8	0x01	ID object: Number of objects
	01	RO	u32	0x00000284	ID object: Supplier ID 0x00000284 : Toshiba Schneider Inverter Co.

4.1.2. SDO sever object

SDO COB-ID object type is only read.

Index (Hex)	Sub index	Access	Type	Default value	Description
1200	00	RO	u8	0x02	Server SDO : Number of entries
	01	RO	u32	0x00000600 + Node-ID	Server SDO : COB-ID Client -> Drive (receive)
	02	RO	u32	0x00000580 + Node-ID	Server SDO : COB-ID Client <- Drive (transmit)

4.1.3. PDO object

PDO1 to PDO3 and PDO21.

PDO set	RPDO	TPDO	Note
PDO1	Controlword	Statusword	COB-ID is variable mapping. TPDO1 : 0x00000180+Node-ID RPDO2 : 0x00000200+Node-ID
	vl_target_velocity	vl_velocity_actual_value	
	variable mapping	variable mapping	
	variable mapping	variable mapping	
PDO2	variable mapping	variable mapping	COB-ID is variable mapping. TPDO2 : 0x00000280+Node-ID RPDO2 : 0x00000300+Node-ID
	variable mapping	variable mapping	
	variable mapping	variable mapping	
	variable mapping	variable mapping	
PDO3	variable mapping	variable mapping	COB-ID is variable mapping. TPDO3 : 0x00000380+Node-ID RPDO3 : 0x00000400+Node-ID
	variable mapping	variable mapping	
	variable mapping	variable mapping	
	variable mapping	variable mapping	
PDO21	variable mapping	variable mapping	COB-ID is variable mapping. TPDO21 : 0x00000480+Node-ID RPDO21 : 0x00000500+Node-ID
	variable mapping	variable mapping	
	variable mapping	variable mapping	
	variable mapping	variable mapping	

4.1.4. RPDO object

Index (Hex)	Sub index	Access	Type	Default value	Description
1400	00	R	u8	0x02	Receive PDO1: Number of objects
	01	R/W	u32	0x00000200 + Node-ID	Receive PDO1: COB-ID entry The default value is 0x00000200 (parameter data [7 1 !])+Node-ID. If set other than 0x00000200 except bit31, new set data is used for COB-ID(=new data). Bit31 is an enable/disable flag of RPDO1 data set.
	02	R	u8	0x0FF	Receive PDO1: Transmission type "asynchronous" (254 or 255), "synchronous" (0 - 240).
1401	00	R	u8	0x02	Receive PDO2: Number of objects
	01	R/W	u32	0x80000300 + Node-ID	Receive PDO2 COB-ID entry The default value is 0x80000300 (parameter data [7 2 !])+Node-ID. If set other than 0x80000300 except bit31, new set data is used for COB-ID(=new data). Bit31 is an enable/disable flag of RPDO2 data set.
	02	R/W	u8	0x0FF	Receive PDO2: Transmission type "asynchronous" (254 or 255), "synchronous" (0 -240).
1402	00	R	u8	0x02	Receive PDO3: Number of objects
	01	R/W	u32	0x80000400+ Node-ID	Receive PDO3 COB-ID entry The default value is 0x00000400 (parameter data [7 3 !])+Node-ID. If set other than 0x80000400 except bit31, new set data is used for COB-ID(=new data). Bit31 is an enable/disable flag of RPDO3 data set.
	02	R/W	u8	0x0FF	Receive PDO3: Transmission type "asynchronous" (254 or 255), "cyclic synchronous" (0 -240).

1414	00	R	u8	0x02	Receive PDO21: Number of objects
	01	R/W	u32	0x80000500 + Node-ID	Receive PDO21 COB-ID entry The default value is 0x80000500 (parameter data [74]) +Node-ID. If set other than 0x80000500 except bit31, new set data is used for COB-ID(=new data). Bit31 is an enable/disable flag of RPDO21 data set.
	02	R/W	u8	0x0FF	Receive PDO21: Transmission type "asynchronous" (254 or 255), "synchronous" (0 -240).
1600	00	R/W	u8	0x02	Receive PDO1 assignment: Number of objects assigned Set 0(=Disable) before changing Sub-index 01-04 of this Object, and set Sub-index 01-04 values of the corresponding sub-indices then set the number of mapped objects (=Enable).
	01	R/W	u32	0x60400010	Receive PDO1 assignment: 1 st object assigned Control word "CMD" (Object 6040, Sub-index 00, 16bit)
	02	R/W	u32	0x60420010	Receive PDO1 assignment: 2 nd object assigned vI target velocity (Object 6042, Sub-index 00, 16bit)
	03	R/W	u32	0x00000000	Receive PDO1 assignment: 3 rd object assigned
	04	R/W	u32	0x00000000	Receive PDO1 assignment: 4 th object assigned
1601	00	R/W	u8	0x01	Receive PDO2 assignment: Number of objects assigned
	01	R/W	u32	0x60400010	Receive PDO2 assignment: 1 st object assigned
	02	R/W	u32	0x00000000	Receive PDO2assignment: 2 nd object assigned
	03	R/W	u32	0x00000000	Receive PDO2 assignment: 3 rd object assigned
	04	R/W	u32	0x00000000	Receive PDO2 assignment: 4 th object assigned
1602	00	R/W	u8	0x01	Receive PDO3 assignment: Number of objects assigned
	01	R/W	u32	0x60400010	Receive PDO3 assignment: 1 st object assigned
	02	R/W	u32	0x00000000	Receive PDO3assignment: 2 nd object assigned
	03	R/W	u32	0x00000000	Receive PDO3 assignment: 3 rd object assigned
	04	R/W	u32	0x00000000	Receive PDO3 assignment: 4 th object assigned
1614	00	R/W	u8	0x01	Receive PDO21 assignment: Number of objects assigned
	01	R/W	u32	0x60400010	Receive PDO21 assignment: 1 st object assigned
	02	R/W	u32	0x00000000	Receive PDO21assignment: 2 nd object assigned
	03	R/W	u32	0x00000000	Receive PDO21 assignment: 3 rd object assigned
	04	R/W	u32	0x00000000	Receive PDO21 assignment: 4 th object assigned

4.1.5. TPDO object

Index (Hex)	Sub index	Access	Type	Default value	Description
1800	00	R	u8	0x05	Transmit PDO1: Number of entries
	01	R/W	u32	0x00000180 + Node-ID	Transmit PDO1: COB-ID The default value is 0x00000180 (parameter data [7 13]) +Node-ID. If set other than 0x00000180 except bit31, new set data is used for COB-ID(=new data). Bit31 is an enable/disable flag of TPDO1 data set.
	02	R/W	u8	0x0FF	Transmit PDO1: Transmission type: "asynchronous" (254 or 255), "cyclic synchronous" (0~240).
	03	R/W	u16	0x001E	Transmit PDO1: Inhibit time: unit = 100us Minimum time between two transmissions
	04	R/W	u8	0x00	Transmit PDO1: Reserved
	05	R/W	u16	0x0064	Transmit PDO1: Event timer: 0=Disable, unit = 1 ms When Transmission type=254 or 255, this object defines a transmission frequency for this PDO.
1801	00	R	u8	0x05	Transmit PDO2: Number of entries
	01	R/W	u32	0x80000280 + Node-ID	Transmit PDO2: COB-ID The default value is 0x80000280 (parameter data [7 23]) +Node-ID. If set other than 0x80000280 except bit31, new set data is used for COB-ID(=new data). Bit31 is an enable/disable flag of TPDO2 data set.
	02	R/W	u8	0x0FF	Transmit PDO2 : Transmission type: "asynchronous" (254 or 255), "cyclic synchronous" (0~240).
	03	R/W	u16	0x001E	Transmit PDO2: Inhibit time: unit = 100us Minimum time between two transmissions
	04	R/W	u8	0x00	Transmit PDO2: Reserved
	05	R/W	u16	0x0064	Transmit PDO2: Event timer: 0=Disable, unit = 1 ms When Transmission type=254 or 255, this object defines a transmission frequency for this PDO.
1802	00	R	u8	0x05	Transmit PDO3: Number of entries
	01	R/W	u32	0x80000380 + Node-ID	Transmit PDO3: COB-ID The default value is 0x80000380 (parameter data [7 33]) +Node-ID. If set other than 0x80000380 except bit31, new set data is used for COB-ID(=new data). Bit31 is an enable/disable flag of TPDO3 data set.
	02	R/W	u8	0x0FF	Transmit PDO3: Transmission type: "asynchronous" (254 or 255), "cyclic synchronous" (0~240).
	03	R/W	u16	0x001E	Transmit PDO3: Inhibit time: unit = 100us Minimum time between two transmissions
	04	R/W	u8	0x00	Transmit PDO3: Reserved
	05	R/W	u16	0x0064	Transmit PDO3: Event timer: 0=Disable, unit = 1 ms When Transmission type=254 or 255, this object defines a transmission frequency for this PDO.
1814	00	R	u8	0x05	Transmit PDO21: Number of entries
	01	R/W	u32	0x80000480 + Node-ID	Transmit PDO21: COB-ID The default value is 0x80000480 (parameter data [7 43]) +Node-ID. If set other than 0x80000480 except bit31, new set data is used for COB-ID(=new data). Bit31 is an enable/disable flag of TPDO21 data set.
	02	R/W	u8	0x0FF	Transmit PDO21: Transmission type: "asynchronous" (254 or 255), "cyclic synchronous" (0~240).
	03	R/W	u16	0x001E	Transmit PDO21: Inhibit time: unit = 100us Minimum time between two transmissions
	04	R/W	u8	0x00	Transmit PDO21: Reserved
	05	R/W	u16	0x0064	Transmit PDO21: Event timer: 0=Disable, unit = 1 ms When Transmission type=254 or 255, this object defines a transmission frequency for this PDO.

Index (Hex)	Sub index	Access	Type	Default value	Description
1A00	00	R/W	u8	0x02	Transmit PDO1 assignment: Number of objects assigned Set 0(=Disable) before changing Sub-index 01-04 of this Object, and set Sub-index 01-04 values of the corresponding sub-indices then set the number of mapped objects (=Enable).
	01	R/W	u32	0x60410010	Transmit PDO1 assignment: 1 st object assigned Statusword (Object 6041, Sub-index 00, 16bit)
	02	R/W	u32	0x60440010	Transmit PDO1 assignment: 2 nd object assigned vl velocity actual value (Object 6044, Sub-index 00, 16bit)
	03	R/W	u32	0x00000000	Transmit PDO1 assignment: 3 rd object assigned
	04	R/W	u32	0x00000000	Transmit PDO1 assignment: 4 th object assigned
1A01	00	R/W	u8	0x01	Transmit PDO2 assignment: Number of objects assigned
	01	R/W	u32	0x60410010	Transmit PDO2 assignment: 1 st object assigned
	02	R/W	u32	0x00000000	Transmit PDO2 assignment: 2 nd object assigned
	03	R/W	u32	0x00000000	Transmit PDO2 assignment: 3 rd object assigned
	04	R/W	u32	0x00000000	Transmit PDO2 assignment: 4 th object assigned
1A02	00	R/W	u8	0x01	Transmit PDO3 assignment: Number of objects assigned
	01	R/W	u32	0x60410010	Transmit PDO3 assignment: 1 st object assigned
	02	R/W	u32	0x00000000	Transmit PDO3 assignment: 2 nd object assigned
	03	R/W	u32	0x00000000	Transmit PDO3 assignment: 3 rd object assigned
	04	R/W	u32	0x00000000	Transmit PDO3 assignment: 4 th object assigned
1A14	00	R/W	u8	0x01	Transmit PDO21 assignment: Number of objects assigned
	01	R/W	u32	0x60410010	Transmit PDO21 assignment: 1 st object assigned
	02	R/W	u32	0x00000000	Transmit PDO21 assignment: 2 nd object assigned
	03	R/W	u32	0x00000000	Transmit PDO21 assignment: 3 rd object assigned
	04	R/W	u32	0x00000000	Transmit PDO21 assignment: 4 th object assigned

4.2. Manufacturer specific profile

Inverter parameters are defined as Manufacturer Specific Objects.

Inverter parameter F*** are defined as 0x2****. So inverter parameters from F000 to FFFF are accessed from network as Objects.

Parameters No. except below table are not accessible from CANopen.

But EDS file supports only the original CPU version parameter set.

Parameter No.	Comm. No.	Object No.	Trans. type	Note
F000 ~ F999	0000 ~ 0999	2000 ~ 2999	SDO	User parameter area
FA00 ~ FFFF	FA00 ~ FFFF	2A00 ~ 2FFF	SDO PDO	Disclosed command and monitor parameter No. can be mapped. Refer to the communication manual.
A000 ~ AFFF	A000 ~ AFFF	3000 ~ 3FFF	SDO	User parameter area
C000 ~ CFFF	C000 ~ CFFF	4000 ~ 4FFF	SDO	User parameter area

4.3. Device Profile (CiA 402)

VF-S15 supports CiA 402 Drives and motion control device profile, velocity mode objects.

Index (Hex)	Sub index	Access	Type	PDO Mapping	Default value	Description
603F	00	R	u16	Yes	0x0000	Error code
6040	00	R/W	u16	Yes	0x0000	Controlword
6041	00	R	u16	Yes	0x0000	Statusword
6042	00	R/W	i16	Yes	0x0000	VI_Target_Velocity (min ⁻¹)
6043	00	R	i16	Yes	0x0000	VI_Velocity_Demand (min ⁻¹)
6044	00	R	i16	Yes	0x0000	VI_Velocity_Actual_Value (min ⁻¹)
6046	00	R	u8	No	0x02	VI Velocity Min Max Amount
	01	R/W	u32	No	0x0000	VI_Velocity_Min_Amount (min ⁻¹)
	02	R/W	u32	No	0x0000 05DC	VI_Velocity_Max_Amount (min ⁻¹)
6048	00	R	u8	No	0x02	VI Velocity Acceleration: Highest sub-index supported
	01	R/W	u32	No	0x0000 05DC	VI_Velocity_Acceleration Delta_Speed (min ⁻¹)
	02	R/W	u16	No	0x000A	VI_Velocity_Acceleration Delta_Time (s)
6049	00	R	u8	No	0x02	VI Velocity Deceleration: Highest sub-index supported
	01	R/W	u32	No	0x0000 05DC	VI_Velocity_Deceleration Delta_Speed (min ⁻¹)
	02	R/W	u16	No	0x000A	VI_Velocity_Deceleration Delta_Time (s)
604A	00	R	u8	No	0x02	VI Velocity Quick Stop: Highest sub-index supported
	01	R/W	u32	No	0x0000 0D5C	VI_Velocity_Quick_Stop Delta_Speed (min ⁻¹)
	02	R/W	u16	No	0x0006	VI_Velocity_Quick_Stop Delta_Time (s)
605A	00	R/W	i16	No	0x02	Quick Stop Option Code

5. Drive profile

Using CiA 402 Drive profile, form CANopen network, the drive can be controlled. When using the drive profile command, please set the command mode selection to CANopen ($C N O d=3$), Frequency setting mode selection 1 to CANopen ($F N O d=5$) and Number of motor poles for communication ($F B 5 5$) parameters.

⚠ Warning

 Mandatory action	▼ If use and set RS485 communication command parameter, the infinite state machine of drive profile can not work expected behavior and may be damage the drive or cause danger. So when use RS485 command parameter, do not access the drive object profile.
---	--

5.1. Velocity mode object

Below figure describes the object relation.

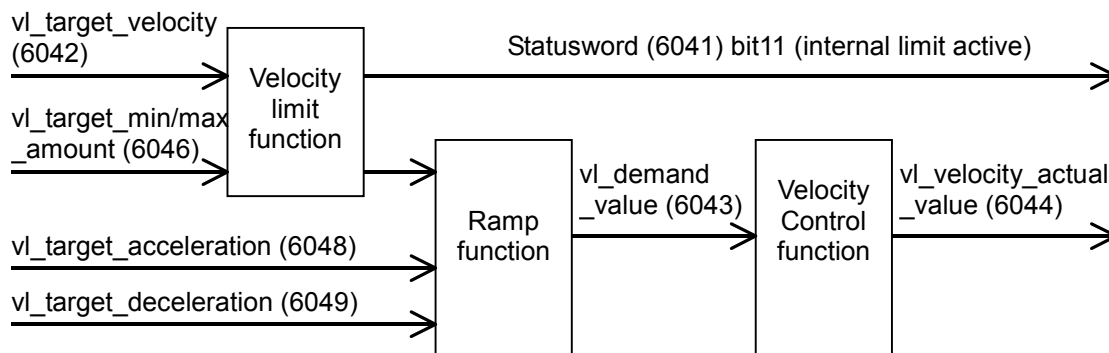

Function	CANopen Protocol
Velocity limit function	Limit the target velocity command (6042) regarding to min/max (6046). And set to inverter frequency command. If target velocity command is over or less than 6046 value, set limit value to the inverter.
Ramp Function	Ramp function is provided by the inverter. CANopen protocol read the demand value and set to 6043.
Velocity Control function	CANopen protocol read demand value and set to 6044.

5.1.1. Object 603Fh: Error Code

Below table describes the relations of the error code and inverter error.

Error code	Meaning	Inverter trip code	Inverter error name	Inverter condition
0000h	No error	00	---	---
1000h	Generic error	0x0E 0x15 0x16 0x17 0x1A 0x1C 0x28 0x35 0x3A 0x3F 0x55 0x56	<i>OL2</i> <i>Err2</i> <i>Err3</i> <i>Err4</i> <i>Err7</i> <i>Err9</i> <i>Et n</i> <i>E-21</i> <i>E-26</i> <i>E-31</i> <i>Et n2</i> <i>Et n3</i>	Motor overload Main unit RAM fault Main unit ROM fault CPU fault 1 Current detector fault --- Auto-tuning error CPU fault 2 CPU fault 3 Heavy cycle of main power ON/OFF Auto-tuning error Auto-tuning error
2230h	Short circuit/earth leakage (device internal)	0x05	<i>OCR</i>	Short circuit in arm
2310h	Continuous over current	0x01 0x02 0x03	<i>OC1</i> <i>OC2</i> <i>OC3</i>	Over-current during acceleration Over-current during deceleration Over-current during constant speed operation
2311h	Continuous over-current No. 1	0x20 0x41 0x48	<i>OL</i> <i>OL2</i> <i>OLC3</i>	Torque overload fault Torque overload fault Torque or current overload fault
2320h	Short circuit/earth leakage (motor-side)	0x04	<i>OCL</i>	Over-current in load at startup
2330h	Earth leakage	0x22	<i>EF2</i>	Input phase failure
3110h	Mains over-voltage	0x0A 0x0B 0x0C	<i>OP1</i> <i>OP2</i> <i>OP3</i>	Overvoltage during acceleration Overvoltage during deceleration Overvoltage during constant speed operation
3120h	Mains under-voltage	0x1E	<i>UP1</i>	The input voltage (in the main circuit) is too low.
3130h	Phase failure	0x08	<i>EPH1</i>	Input phase failure
3310h	Output over-voltage	0x09 0x0F	<i>EPHO</i> <i>OLr</i>	Motor 1-phase loss Dynamic braking resistor overload trip
4210h	Excess temperature device	0x0D 0x10 0x3E	<i>OL1</i> <i>OH</i> <i>OL3</i>	Inverter overload Overheat Main module overload
5530h	Control EEPROM failure	0x12 0x13 0x14 0x29	<i>EEP1</i> <i>EEP2</i> <i>EEP3</i> <i>Et4P</i>	EEPROM fault 1 (writing error) EEPROM fault 2 (reading error) EEPROM fault 3 (internal fault) Inverter type error
6100h	Internal software	0x33 0x37	<i>E-19</i> <i>E-23</i>	CPU communication error CPU communication error
7300h	Sensor	0x2E 0x32 0x40	<i>OH2</i> <i>E-18</i> <i>E-32</i>	Brea in analog signal cable
7310h	Speed	0x2D	<i>E-13</i>	Over speed fault
7510h	Serial interface No. 1	0x18	<i>Err5</i>	Remote control error
7520h	Serial interface No. 2	0x1B	<i>Err8</i>	
8100h	Communication - generic	---	<i>t</i>	CANopen communication – generic
8130h	Life guard error or heartbeat error	---	<i>t</i>	CANopen life guard error or heartbeat error
8140h	Recovered from bus off	---	<i>t</i>	CANopen recovered from bus off

8331h	Torque fault	0x2F	<i>S O U t</i>	Step-out (for PM motor drive only)
8501h		0x45	<i>E - 37</i>	Servo lock fault
9000h	External malfunction	0x11 0x2A	<i>E</i> <i>E - 10</i>	Emergency stop Analog input terminal overvoltage
FF00h	Additional functions - generic error	0x54	<i>E t n 1</i>	Auto-tuning error
FF03h	Device specific - generic error	0x1D 0x3B 0x49	<i>U.C</i> <i>E - 27</i> <i>U t C 3</i>	Low-current operation Trip Internal circuit fault Low-torque or current fault

*1: Error code: same information as lower 16-bit of the pre-defined error code field (1003h sub-index 01h)

*2: Inverter trip code: Inverter internal error code

5.1.2. Object 6040h: Controlword

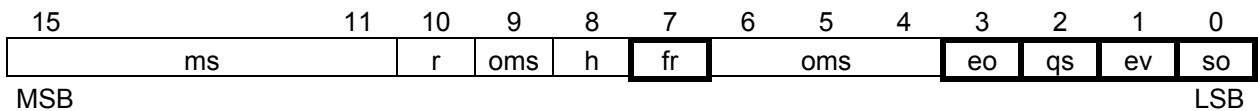

- ms = manufacturer-specific;
- r = reserved;
- oms = operation mode specific;
- h = halt;
- fr = fault reset;**
- eo = enable operation;**
- qs = quick stop;**
- ev = enable voltage;**
- so = switch on** **Bold bits shall be supported, other may be supported.**

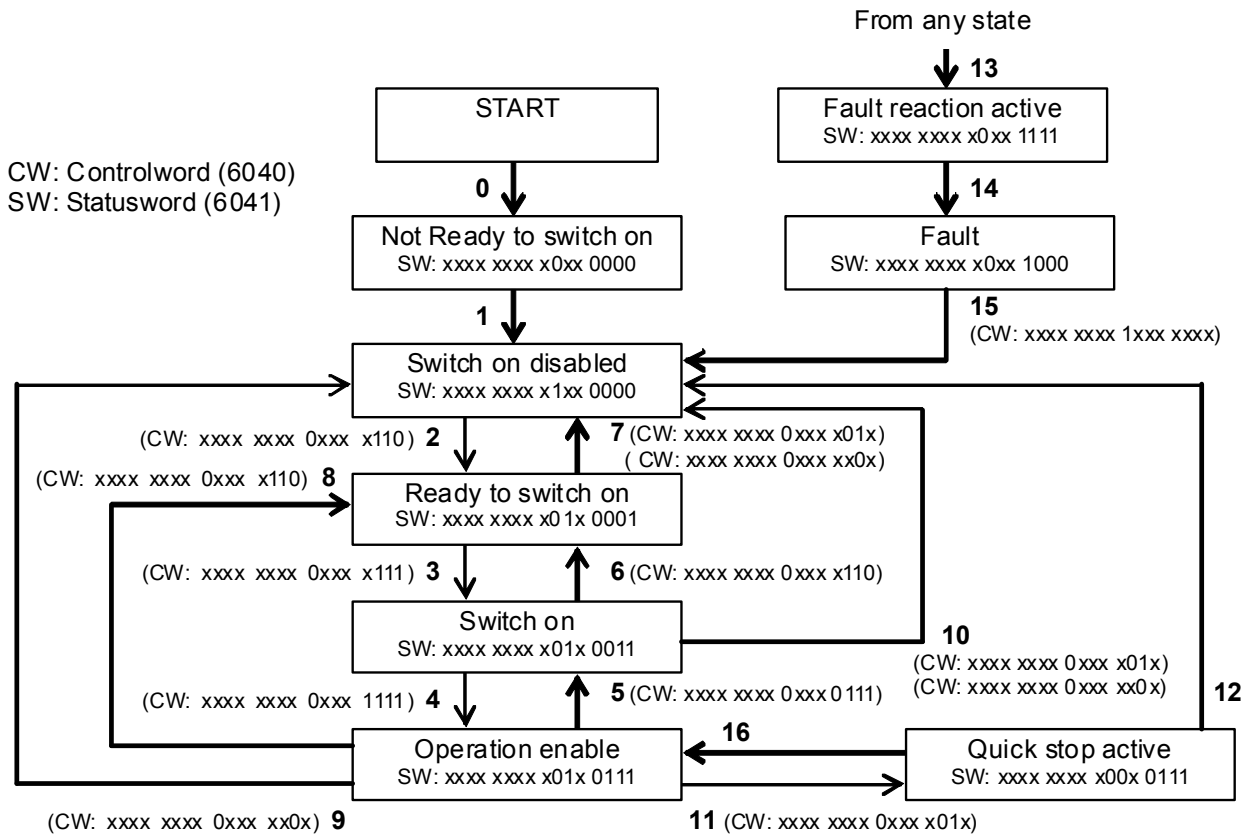

Command coding (CiA DS402-2 DSP V3.0 Table 27)

Command	Bits of the Controlword					Transitions
	fault reset	enable operation	Quick stop	enable voltage	switch on	
	Bit 7	Bit 3	Bit 2	Bit 1	Bit 0	
Shutdown	0	x	1	1	0	2, 6, 8
Switch on	0	0	1	1	1	3
Switch on + enable operation	0	1	1	1	1	3 + 4 Note
Disable voltage	0	x	x	0	x	7, 9, 10, 12
Quick stop	0	x	0	1	x	7, 10, 11
Disable operation	0	0	1	1	1	5
Enable operation	0	1	1	1	1	4, 16
Fault reset	↑	x	x	x	x	15

NOTE Automatic transition to Enable operation state after executing SWITCHED ON state functionality. When detects main power loss or not release main power loss in 3 sec after change to "Switch on state", the state is changed to "Switch on disable".

Transition events and action (CiA DS402-2 DSP V3.0 Table 26)

Transition	Event(s)	Action(s)
0	Automatic transition after power-on or reset application	Drive device self-test and/or self initialisation shall be performed.
1	Automatic transition	Communication shall be activated.
2	Shutdown command from control device or local signal	None
3	Switch on command received from control device or local signal	The high-level power shall be switched on, if possible.
4	Enable operation command received from control device or local signal	The drive function shall be enabled and all internal set-points cleared.
5	Disable operation command received from control device or local signal	The drive function shall be disabled.
6	Shutdown command received from control device or local signal	The high-level power shall be switched off, if possible.
7	Quick stop or disable voltage command from control device or local signal	None
8	Shutdown command from control device or local signal	The drive function shall be disabled, and the high-level power shall be switched off, if possible.
9	Disable voltage command from control device or local signal	The drive function shall be disabled, and the high-level power shall be switched off, if possible.
10	Disable voltage or quick stop command from control device or local signal	The high-level power shall be switched off, if possible.
11	Quick stop command from control device or local signal	The quick stop function shall be started.
12	Automatic transition when the quick stop function is completed and quick stop option code (605A) is 1, 2, 3 or 4, or disable voltage command received from control device (depends on the quick stop option code)	The drive function shall be disabled, and the high-level power shall be switched off, if possible.
13	Fault signal (see also /CiA402-3/)	The configured fault reaction function shall be executed.
14	Automatic transition	The drive function shall be disabled; the high-level power shall be switched off, if possible.
15	Fault reset command from control device or local signal	A reset of the fault condition is carried out, if no fault exists currently on the drive device; after leaving the Fault state, the Fault reset bit in the controlword shall be cleared by the control device.
16	Enable operation command from control device, if the quick stop option code (605A) is 5, 6, 7, or 8	The drive function shall be enabled.

5.1.3. Object 6041: Statusword

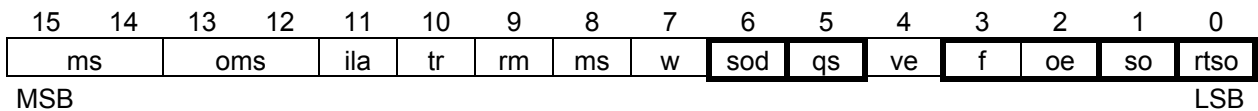

- ms = manufacturer-specific;
- oms = operation mode specific;
- ila = internal limit active;
- tr = target reached;
- rm = remote;
- w = warning;
- sod = switch on disabled;
- qs = quick stop;
- ve = voltage enabled;
- f = fault;
- oe = operation enabled;
- so = switched on;
- rtso = ready to switch on

PDS FSA state	Statusword
Not ready to switch on	xxxx xxxx x0xx 0000
Switch on disabled	xxxx xxxx x1xx 0000
Ready to switch on	xxxx xxxx x01x 0001
Switched on	xxxx xxxx x01x 0011
Operation enabled	xxxx xxxx x01x 0111
Quick stop active	xxxx xxxx x00x 0111
Fault reaction active	xxxx xxxx x0xx 1111
Fault	xxxx xxxx x0xx 1000

5.1.4. Object 6042: vl_target_velocity

This object shall indicate the required velocity of the system. The value is given in revolutions per minute (min^{-1}). Positive values indicates forward direction and negative values indicates reverse direction. At changing to “Operation enable” state, this target velocity is cleared. So set this target velocity data after change the state to “Operation enable”.

5.1.5. Object 6043h: vl_velocity_demand

This object provides the instantaneous velocity generated by the ramp function. It is an internal object of the drive device. The value is given in the same unit as the vl target velocity. Positive values indicates forward direction and negative values indicates reverse direction.

5.1.6. Object 6044: vl_velocity_actual_value

This object provides the velocity at the motor spindle or load. Depending on the implementation (simple drive device, without sensor, with sensor, etc.), the drive provides the appropriate image of the actual velocity (velocity demand, velocity control effort, calculated velocity, measured velocity). The value is given in the same unit as the vl_target_velocity. A positive value indicates forward direction and negative values indicates reverse direction.

5.1.7. Object 6046: vl_velocity_min_max_amount

This object indicates the configured minimum and maximum amount of velocity (unit min^{-1}). The vl_velocity_max amount sub-object is mapped internally to the vl_velocity_max positive and vl_velocity_max negative values. The vl_velocity_min amount sub-object is mapped internally to the vl_velocity_min positive and vl_velocity_min negative values.

At initial configuration, the Upper limit frequency (UL) and Lower limit frequency (LL) of the drive may be not same value with Object 6046 setting value. And when change the Upper limit frequency and the lower limit frequency of the drive parameter, Object 6046 value is different with the drive parameters. To correspond these limit value, set Object 6046. And if need, execute Store Parameters command (Object 1010) to save the parameter to EEPROM.

5.1.8. Object 6048h: vl_velocity_acceleration

This object indicates the configured delta speed and delta time of the slope of the acceleration ramp. Unit is min^{-1} .

Velocity Acceleration Delta Speed : 225 ~ 30,000 min^{-1}
 Velocity Acceleration Delta Time : 0 ~ 3600 s

Note: Do not change the acceleration/deceleration time unit (parameter F519), if change the parameter, the setting value range will be different from above range.

5.1.9. Object 6049: vl_velocity_deceleration

This object shall indicate the configured delta speed and delta time of the slope of the deceleration ramp. Unit is min^{-1} .

Velocity Deceleration Delta Speed : 225 ~ 30,000 min^{-1}
 Velocity Deceleration Delta Time : 0 ~ 3600 s

Note: Do not change the acceleration/deceleration time unit (parameter F519), if change the parameter, the setting value range will be different from above range.

5.1.10. Object 604A: vl_velocity_quick_stop

This object indicates the configured delta speed and delta time of the slope of the deceleration ramp for quick stop. Unit is min^{-1} .

5.1.11. Object 605A: Quick stop option code

This object shall indicate what action is performed when the quick stop function is executed. The slow down ramp is the deceleration value of the used mode of operations.

Value	Definition
-32768 to -1	No function
0	Disable drive function
+1	Slow down on slow down ramp and transit into Switch On Disabled
+2	Slow down on quick stop ramp and transit into Switch On Disabled
+3	Do not set
+4	Slow down on voltage limit and transit into Switch On Disabled
+5	Slow down on slow down ramp and stay in Quick Stop Active
+6	Slow down on quick stop ramp and stay in Quick Stop Active
+7	Do not set
+8	Slow down on voltage limit and stay in Quick Stop Active
+9 to +32 767	Reserved

5.1.12. Object 6060: Modes of operation

This object shall indicate the requested operation mode.
 With the VF-S15, only velocity mode is supported as the operation mode, therefore any request to this object would make no sense.

Value	Definition
-128 to -1	Manufacture-specific operation modes
0	No mode change/no mode assigned
+1	Profile position mode
+2	Velocity mode
+3	Profile velocity mode
+4	Torque profile mode
+5	reserved
+6	Homing mode
+7	Interpolated position mode
+8	Cyclic sync position mode
+9	Cyclic sync velocity mode
+10	Cyclic sync torque mode
+11 to +127	Reserved

5.1.13. Object 6061: Modes of operation display

This object shall provide the actual operation mode.
 With the VF-S15, only velocity mode is supported as the operation mode, therefore only 0x02 can be displayed.

Value	Definition
+2	Velocity mode

5.1.14. Object 6502: Supported drive mode

This object shall provide the information on the supported drive mode.
 With the VF-S15, only velocity mode is supported as the operation mode, therefore only 0x00000002 can be provided.

31	16	15	10	9	8	7	6	5	4	3	2	1	0
Manufacture-specific	reserved	cst	csv	csp	ip	hm	r	tq	pv	vl	pp		
0	0	0	0	0	0	0	0	0	0	0	0	1	0
MSB												LSB	

6. Control from CANopen Network

6.1. NMT state machine

Below figure describes NMT state machine.

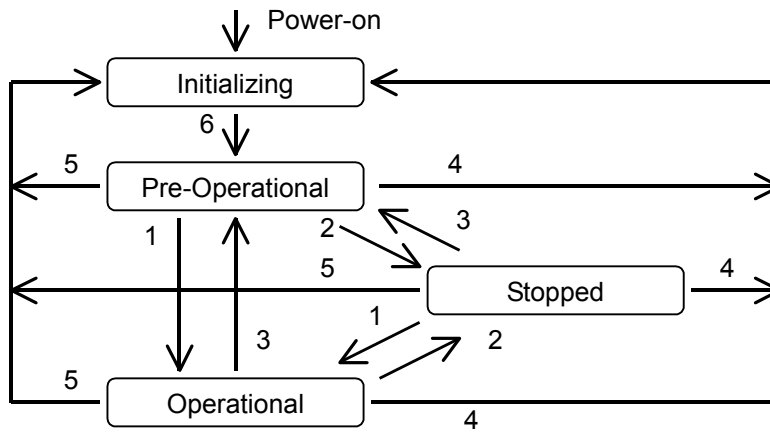

State No.	NMT Service	COB-ID	RTR	DLC	Data0	Data1	Data2 ~ 7
1	Start Remote Node	0x000	0	2	0x01	Node-ID	0x00,...,0x00
2	Stop Remote Node	0x000	0	2	0x02	Node-ID	0x00,...,0x00
3	Enter Pre-Operational State	0x000	0	2	0x80	Node-ID	0x00,...,0x00
4	Reset Node	0x000	0	2	0x81	Node-ID	0x00,...,0x00
5	Reset Communication	0x000	0	2	0x82	Node-ID	0x00,...,0x00
6	Device initialization finished, enter Pre-Operational state automatically, send Boot-up message	0x700+ Node-ID	0	1	0x00	0x00,...,0x00	

6.2. SDO communication

Using SDO(Service Data Object) communication, the inverter parameters and CANopen object data can be read or wrote. When write Communication profile data, please confirm the NMT state machine is Pre-Operational state.

NMT State	SDO			PDO
	Communication Profile #1000 ~ #1FFF	Manufacturer Specific Profile #2000 ~ #5FFF	Standard Device Profile #6000 ~ #9FFF	
Stopped	---	---	---	---
Initializing	---	---	---	---
Pre-Operational	Read / Write	Read / Write *1	Read / Write	---
Operational	Read	Read / Write *1	Read / Write	Read / Write

*1: Write access is depending on each parameter.

6.2.1. Read object (Upload object)

Sending below data, the object data can be read.

Send data to read object

COB-ID	RTR	DLC	Data0	Data1	Data2	Data3	Data4	Data5	Data6	Data7
0x600+ Node-ID	0	4	40	Obj. No.		Sub index	---	---	---	---
				L	H					

Response data for read object (byte)

COB-ID	RTR	DLC	Data0	Data1	Data2	Data3	Data4	Data5	Data6	Data7
0x600+ Node-ID	0	8	4f	Obj. No.		Sub index	Data	---	---	---
				L	H					

Response data for read object (word)

COB-ID	RTR	DLC	Data0	Data1	Data2	Data3	Data4	Data5	Data6	Data7
0x600+ Node-ID	0	8	4b	Obj. No.		Sub index	Data		---	---
				L	H		L	H		

Response data for read object (long)

COB-ID	RTR	DLC	Data0	Data1	Data2	Data3	Data4	Data5	Data6	Data7
0x600+ Node-ID	0	8	43	Obj. No.		Sub index	Data			
				L	H		LL	LH	HL	HH

Error response (Refer to 6.2.3 Abort code)

COB-ID	RTR	DLC	Data0	Data1	Data2	Data3	Data4	Data5	Data6	Data7
0x600+ Node-ID	0	8	43	Obj. No.		Sub index	Data			
				L	H		LL	LH	HL	HH

6.2.2. Write object (Download object)

Sending below data, the object data can be wrote.

Send data to write object (byte)

COB-ID	RTR	DLC	Data0	Data1	Data2	Data3	Data4	Data5	Data6	Data7
0x600+ Node-ID	0	8	2f	Obj. No.		Sub index	Data	---	---	---
				L	H					

Send data to write object (word)

COB-ID	RTR	DLC	Data0	Data1	Data2	Data3	Data4	Data5	Data6	Data7
0x600+ Node-ID	0	8	2b	Obj. No.		Sub index	Data		---	---
				L	H		L	H		

Send data to write object (long)

COB-ID	RTR	DLC	Data0	Data1	Data2	Data3	Data4	Data5	Data6	Data7
0x600+ Node-ID	0	8	23	Obj. No.		Sub index	Data			
				L	H		LL	LH	HL	HH

Response data for write object

COB-ID	RTR	DLC	Data0	Data1	Data2	Data3	Data4	Data5	Data6	Data7
0x580+ Node-ID	0	8	60	Obj. No.		Sub index	---	---	---	---
				L	H					

Error response (Refer to 6.2.3 Abort code)

COB-ID	RTR	DLC	Data0	Data1	Data2	Data3	Data4	Data5	Data6	Data7
0x580+ Node-ID	0	8	80	Obj. No.		Sub index	Abort Code			
				L	H		LL	LH	HL	HH

6.2.3. Abort code

The abort code in the below table are set in the error response data.

Abort Code	Contents
0503 0000	Toggle bit not alternated.
0504 0000	SDO protocol timed out.
0504 0001	Client/server command specifier not valid or unknown.
0504 0002	Invalid block size (block mode only).
0504 0003	Invalid sequence number (block mode only).
0504 0004	CRC error (block mode only).
0504 0005	Out of memory.
0601 0000	Unsupported access to an object.
0601 0001	Attempt to read a write only object.
0601 0002	Attempt to write a read only object.
0602 0000	Object does not exist in the object dictionary.
0604 0041	Object cannot be mapped to the PDO.
0604 0042	The number and length of the objects to be mapped would exceed PDO length.
0604 0043	General parameter incompatibility reason.
0604 0047	General internal incompatibility in the device.
0606 0000	Access failed due to an hardware error.
0607 0010	Data type does not match, length of service parameter does not match
0607 0012	Data type does not match, length of service parameter too high
0607 0013	Data type does not match, length of service parameter too low
0609 0011	Sub-index does not exist.
0609 0030	Invalid value for parameter (download only).
0609 0031	Value of parameter written too high (download only).
0609 0032	Value of parameter written too low (download only).
0609 0036	Maximum value is less than minimum value.
060A 0023	Resource not available: SDO connection
0800 0000	General error
0800 0020	Data cannot be transferred or stored to the application.
0800 0021	Data cannot be transferred or stored to the application because of local control.
0800 0022	Data cannot be transferred or stored to the application because of the present device state.
0800 0023	Object dictionary dynamic generation fails or no object dictionary is present (e.g. object dictionary is generated from file and generation fails because of an file error).
0800 0024	No data available

6.3. PDO communication

Using PDO (Process Data Object) communication, send and receive inverter command and monitor data with synchronously or asynchronously.

6.3.1. TxPDO and RxPDO communication type

TxPDO (Inverter send PDO) can be set below condition in table.

- TxPDO1 Transmission type : Object 1800h subindex 02
- TxPDO2 Transmission type : Object 1801h subindex 02
- TxPDO3 Transmission type : Object 1802h subindex 02
- TxPDO21 Transmission type : Object 1814h subindex 02

TxPDO Transmission type()

Transmission type	Condition to trigger PDO			PDO Transmission
	SYNC	RTR	Event	
0	✓	(✓)	✓	Send at the monitor value changes from last sending and received SYNC message (or sampling and send at RTR received)
1 ~ 240	✓	(✓)	---	Send at n times SYNC message received (or sampling and send at RTR received)
241 ~ 251	---	---	---	No function
252	✓	✓	---	Sampling at SYNC message and send at received RTR message
253	---	✓	---	Sampling and send at received RTR message
254	---	(✓)	✓	At the monitor value changes from the last sending and past the inhibit time.
255	---	(✓)	✓	Or at past the event time setting. (or sampling and send at RTR received)

RxPDO (Inverter receive PDO) can be set below condition in table.

- RxPDO1 Transmission type : Object 1400h subindex 02
- RxPDO2 Transmission type : Object 1401h subindex 02
- RxPDO3 Transmission type : Object 1402h subindex 02
- RxPDO21 Transmission type : Object 1414h subindex 02

RxPDO Transmission type

Transmission type	Condition to trigger PDO			PDO Transmission
	SYNC	RTR	Event	
0 ~ 240	✓	---	---	RxPDO updated at SYNC receive
241 ~ 253	---	---	---	No function
254	---	---	✓	RxPDO updated immediately
255	---	---	✓	RxPDO updated immediately

6.3.2. RTR (Remote Transfer Request) communication

When set RTR setting into TxPDO Transmission type (1800h, 1801h, 1802h, 1814h subindex 02), sending the RTR (Remote Transfer Request) message, Inverter send TxPDO message.

TxPDO1 RTR message data

COB-ID	RTR	DLC	Data0	Data1	Data2	Data3	Data4	Data5	Data6	Data7
0x180+ Node-ID	1	0	---	---	---	---	---	---	---	---

TxPDO2 RTR message data

COB-ID	RTR	DLC	Data0	Data1	Data2	Data3	Data4	Data5	Data6	Data7
0x280+ Node-ID	1	0	---	---	---	---	---	---	---	---

TxPDO3 RTR message data

COB-ID	RTR	DLC	Data0	Data1	Data2	Data3	Data4	Data5	Data6	Data7
0x380+ Node-ID	1	0	---	---	---	---	---	---	---	---

TxPDO21 RTR message data

COB-ID	RTR	DLC	Data0	Data1	Data2	Data3	Data4	Data5	Data6	Data7
0x480+ Node-ID	1	0	---	---	---	---	---	---	---	---

6.3.3. SYNC communication

When set SYNC type into TxPDO Transmission type (1800h, 1801h, 1802h, 1814h subindex 02) or RxPDO Transmission type (1400h, 1401h, 1402h, 1414h subindex 02), update command or send monitor data synchronously to the SYNC message.

And send SYNC message with count data, the inverter SYNC counter are preset with SYNC counter data. When change the node state, the SYNC count data in the inverter is cleared.

SYNC send data

COB-ID	RTR	DLC	Data0	Data1	Data2	Data3	Data4	Data5	Data6	Data7
0x080	0	0	---	---	---	---	---	---	---	---

SYNC send data with count data

COB-ID	RTR	DLC	Data0	Data1	Data2	Data3	Data4	Data5	Data6	Data7
0x080	0	1	Count	---	---	---	---	---	---	---

6.3.4. Emergency object

The inverter sends the Emergency message at the inverter detects fault condition or CANopen® communication node state is changed. About Error code, refer to the "5.1.1 Object 603Fh: Error Code"

Emergency send data

COB-ID	RTR	DLC	Data0	Data1	Data2	Data3	Data4	Data5	Data6	Data7
0x080+ Node-ID	0	8	Emergency Error Code		Error Register*1	Manufacture specific error field				
			L	H						

6.4. Communication disconnection detection function

VF-S15 CANopen® supports Heartbeat service and Node Guarding service to detect the communication disconnection.

Heartbeat service and Node Guarding service function can not be active at the same time.

- Heartbeat service
 - Heartbeat Consumer

Watching the heartbeat message of the specific Node-ID, and checking the interval time, the inverter can detect the network abnormal condition.
 - Heartbeat Producer

Sending the heartbeat message of own Node-ID, the inverter can inform its node status.

- Node Guarding service

NMT master polling the Guarding message, NMT master can detect each mode state and network abnormal condition.

Recommend to use Heartbeat service to reduce the network traffic.

6.4.1. Heartbeat Consumer

Heartbeat consumer node can detect abnormal condition by watching the heartbeat message configured specific Node-ID and interval time of Object #1016.

When the inverter detects the network abnormal condition, the inverter changes the drive condition according to the parameter setting ($\zeta 100 \sim \zeta 103$)

6.4.2. Heartbeat producer

Heartbeat producer function sends the heartbeat message with object #1017 interval setting.

Heartbeat message send data

COB-ID	RTR	DLC	Data0	Data1	Data2	Data3	Data4	Data5	Data6	Data7
0x700+ Node-ID	0	1	State	---	---	---	---	---	---	---

State	Comments
0	Boot up
4	Stopped
5	Operational
127	Pre-operational

6.4.3. Node Guarding

When received the Node Guarding message, the inverter send the Node Guarding message with the node state.

When the inverter does not receive the Node Guard message in the interval time (=Guard Time x Time Factor, Max time is limited internally 1 hour.) set by Object #100C (Guard Time) and #100D (Time Factor), the inverter detect the network error and changes the drive condition according to the parameter setting ($\zeta 709$).

Node Guarding send data

COB-ID	RTR	DLC	Data0	Data1	Data2	Data3	Data4	Data5	Data6	Data7
0x700+ Node-ID	1	0	---	---	---	---	---	---	---	---

Response data of Node Guard

COB-ID	RTR	DLC	Data0	Data1	Data2	Data3	Data4	Data5	Data6	Data7
0x700+ Node-ID	0	1	bit7:toggle bit6-0:State	---	---	---	---	---	---	---

Data0		State
bit7	bit6-0	
toggle	0	Initialising
	1	Disconnected
	2	Connecting
	3	Preparing
	4	Stopped
	5	Operational
	127	Pre-operational

6.4.4. NMT Boot-up

The inverter send the NMT Boot-up message at the drive power on or reset. When the controller received the NMT Boot-up message, should change the inverter node state and send appropriate command data.

NMT Boot-up send data (NMT Master <- NMT Slave (Inverter))

COB-ID	RTR	DLC	Data0	Data1	Data2	Data3	Data4	Data5	Data6	Data7
0x700+ Node-ID	0	1	0	---	---	---	---	---	---	---

7. Example communication

7.1. Asynchronous communication

This is a example communication to control run/stop the inverter and set frequency command.

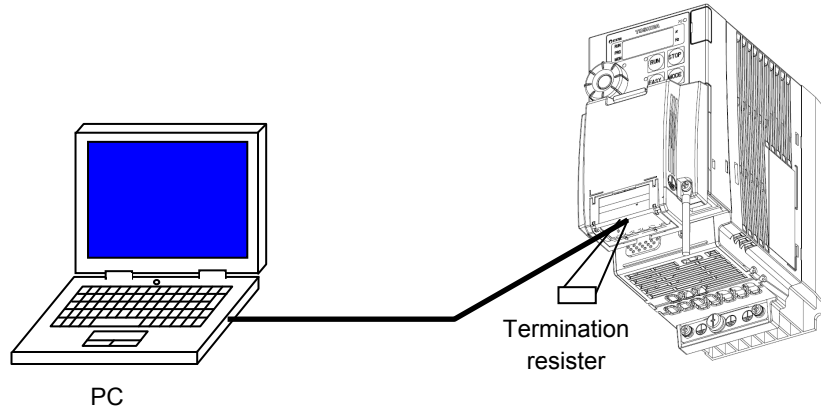

Parameter	Function	Factory setting	Comments	
<i>C70d</i>	Command mode setting	1	3: command from CANopen	
<i>F70d</i>	Frequency command selection	0	6: command from CANopen	
<i>C701</i>	Node-ID	1	1 ~ 127	
<i>C702</i>	Board rate 0: 20k 4: 500k 1: 50k 5: 800k 2: 125k 6: 1M 3: 250k	2 (125kbps)	CAN baud rate setting	
<i>C711</i>	PDO1 Receive: COB-ID entry High word Low word RPDO transmission type Transmit :COB-ID High word Low word TPDO Transition type	0x0000200	#1400 subidx 01 If the setting is default setting, COB-ID is below value. COB-ID = 0x0000200+Node-ID	
<i>C712</i>			0x0000180	#1400 subidx 02 Asynchronous
<i>C713</i>		#1800 subidx 01 If the setting is default setting, COB-ID is below value. COB-ID = 0x0000180+Node-ID		
<i>C714</i>				#1800 subidx 02 Asynchronous
<i>C715</i>		PDO1 Number of objects Command 1 Command 2 Number of objects Monitor 1 Monitor 2		0x02
<i>C716</i>			0x6040	#1600 subidx 01 Command Index No. 0x6040: Controlword
<i>C750</i>	0x6042		#1600 subidx 02 Command Index No. 0x6042: vI target velocity	
<i>C751</i>	0x02		#1A00 subidx 00 Transmit PDO1 assignment: Number of objects assigned	
<i>C752</i>	0x6041		#1A00 subidx 01 Monitor Index No. 0x6041: vI Statusword	
<i>C755</i>	0x6044		#1A00 subidx 02 Monitor Index No. 0x6044: vI velocity actual value	

1. NMT Boot-up (Inverter power on)

INV - PC	COB-ID	RTR	DLC	Data0	Data1	Data2	Data3	Data4	Data5	Data6	Data7
→	0x701	0	8	0	---	---	---	---	---	---	---

2. NMT Module Control (Change Operational state)

INV - PC	COB-ID	RTR	DLC	Data0	Data1	Data2	Data3	Data4	Data5	Data6	Data7
←	0x000	0	8	1	1	---	---	---	---	---	---

3. NMT Node Guarding

INV - PC	COB-ID	RTR	DLC	Data0	Data1	Data2	Data3	Data4	Data5	Data6	Data7
→	0x701	0	8	0x05 or 0x85	---	---	---	---	---	---	---

4. RxPDO1 (Change to “Ready to switch on” state)

INV - PC	COB-ID	RTR	DLC	Data0	Data1	Data2	Data3	Data4	Data5	Data6	Data7
←	0x201	0	8	Control word		vl_target_velocity		---	---	---	---
				0x06	0x00	0x00	0x00				

5. RxPDO1 (Change “Switch on” state)

INV - PC	COB-ID	RTR	DLC	Data0	Data1	Data2	Data3	Data4	Data5	Data6	Data7
←	0x201	0	8	Control word		vl_target_velocity		---	---	---	---
				0x07	0x00	0x00	0x00				

6. RxPDO1 (Change “Operation enable” state and set the speed to 1500min⁻¹ (0x05dc))

INV - PC	COB-ID	RTR	DLC	Data0	Data1	Data2	Data3	Data4	Data5	Data6	Data7
←	0x201	0	8	Control word		vl_target_velocity		---	---	---	---
				0x0f	0x00	0xdc	0x05				

7. RTR TxPDO1 (Request sending the drive status and output frequency data)

INV - PC	COB-ID	RTR	DLC	Data0	Data1	Data2	Data3	Data4	Data5	Data6	Data7
←	0x181	1	0	---	---	---	---	---	---	---	---

8. TxPDO1 (Send the response of the drive status and the output frequency)

INV - PC	COB-ID	RTR	DLC	Data0	Data1	Data2	Data3	Data4	Data5	Data6	Data7
→	0x181	0	8	Status word		vl_velocity actual_value		---	---	---	---
				0x37	0x06	0xdc	0x05				

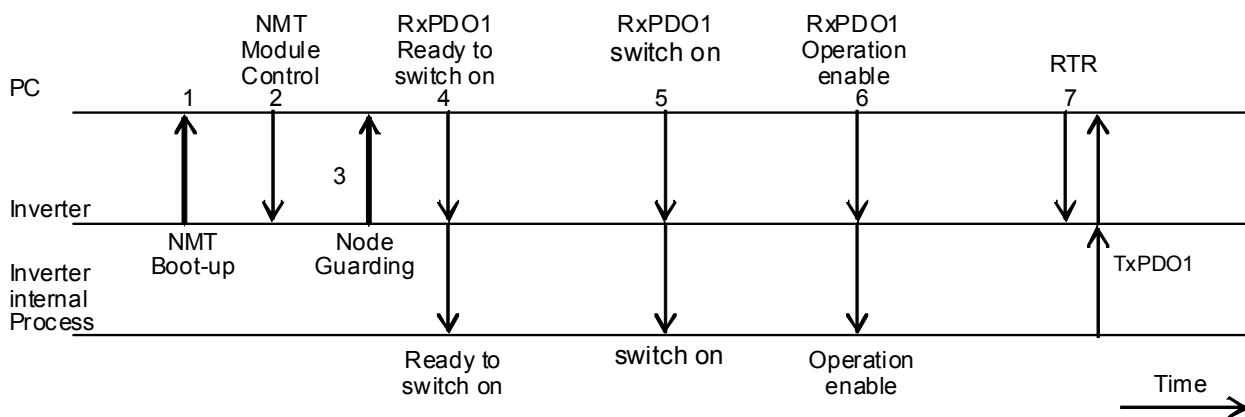

Communication between PC and Inverter

7.2. SYNC communication

This is a sample communication using SYNC message.

Parameter	Function	Factory setting	Comments
<i>C70d</i>	Command mode selection	1	Command from CANopen Network
<i>F70d</i>	Frequency setting mode selection	0	Command from CANopen Network
<i>C701</i>	Node-ID	127	1 ~ 127
<i>C702</i>	Board rate 0: 20k 4: 500k 1: 50k 5: 800k 2: 125k 6: 1M 3: 250k	2 (125kbps)	CAN baud rate setting
<i>C711</i>	PDO1	Receive: COB-ID entry High word	0x0000200 #1400 subidx 01 If the setting is default setting, COB-ID is below value. COB-ID=0x0000200+Node-
<i>C712</i>		Low word	
<i>C713</i>		RPDO transmission type	0x01 #1400 subidx 02 Synchronous
<i>C714</i>		Transmit :COB-ID High word	0x0000180 #1800 subidx 01 If the setting is default setting, COB-ID is below value. COB-ID=0x0000180+Node-ID
<i>C715</i>		Low word	
<i>C716</i>		TPDO Transition type	0x01 #1800 subidx 02 Synchronous
<i>C750</i>	PDO1	Number of objects	0x02 #1600 subidx 00 Receive PDO1 assignment: Number of objects assigned
<i>C751</i>		Command 1	0x6040 #1600 subidx 01 Command Index No. 0x6040: Controlword
<i>C752</i>		Command 2	0x6042 #1600 subidx 02 Command Index No. 0x6042: vl target velocity
<i>C755</i>		Number of objects	0x02 #1A00 subidx 00 Transmit PDO1 assignment: Number of objects assigned
<i>C756</i>		Monitor 1	0x6041 #1A00 subidx 01 Monitor Index No. 0x6041: vl Statusword
<i>C757</i>		Monitor 2	0x6044 #1A00 subidx 02 Monitor Index No. 0x6044: vl velocity actual value

1. NMT Boot-up (Inverter power on)

INV - PC	COB-ID	RTR	DLC	Data0	Data1	Data2	Data3	Data4	Data5	Data6	Data7
→	0x701	0	8	0	---	---	---	---	---	---	---

2. NMT Modeule Control (Change to Operational state)

INV - PC	COB-ID	RTR	DLC	Data0	Data1	Data2	Data3	Data4	Data5	Data6	Data7
←	0x000	0	8	1	1	---	---	---	---	---	---

3. NMT Node Guarding

INV - PC	COB-ID	RTR	DLC	Data0	Data1	Data2	Data3	Data4	Data5	Data6	Data7
→	0x701	0	8	0x05 or 0x85	---	---	---	---	---	---	---

4. RxPDO1 (Change to “Ready to switch on” state)

INV - PC	COB-ID	RTR	DLC	Data0	Data1	Data2	Data3	Data4	Data5	Data6	Data7
←	0x201	0	8	Control word		vl target velocity		---	---	---	---
				0x06	0x00	0x00	0x00				

5. SYNC (Update RxPDO received data to control data)

INV - PC	COB-ID	RTR	DLC	Data0	Data1	Data2	Data3	Data4	Data5	Data6	Data7
←	0x080	0	0	---	---	---	---	---	---	---	---

6. RxPDO1 (Change to “Switch on” state)

INV - PC	COB-ID	RTR	DLC	Data0	Data1	Data2	Data3	Data4	Data5	Data6	Data7
←	0x201	0	8	Control word		vl_target	velocity	---	---	---	---
				0x07	0x00	0x00	0x00				

7. SYNC (Update RxPDO received data to control data)

INV - PC	COB-ID	RTR	DLC	Data0	Data1	Data2	Data3	Data4	Data5	Data6	Data7
←	0x080	0	0	---	---	---	---	---	---	---	---

8. RxPDO1 (Change to “Operation enable” state and set the speed to 1500min⁻¹ (0x05dc))

INV - PC	COB-ID	RTR	DLC	Data0	Data1	Data2	Data3	Data4	Data5	Data6	Data7
←	0x201	0	8	Control word		vl_target	velocity	---	---	---	---
				0x0f	0x00	0xdc	0x05				

9. SYNC (Update RxPDO received data to control data)

INV - PC	COB-ID	RTR	DLC	Data0	Data1	Data2	Data3	Data4	Data5	Data6	Data7
←	0x080	0	0	---	---	---	---	---	---	---	---

10. RTR TxPDO1 (Request the drive status and frequency monitor data)

INV - PC	COB-ID	RTR	DLC	Data0	Data1	Data2	Data3	Data4	Data5	Data6	Data7
←	0x181	1	0	---	---	---	---	---	---	---	---

11. TxPDO1 (Send the response of the drive status and the output frequency)

INV - PC	COB-ID	RTR	DLC	Data0	Data1	Data2	Data3	Data4	Data5	Data6	Data7
→	0x181	0	8	Status word		vl_velocity actual value		---	---	---	---
				0x37	0x06	0xdc	0x05				

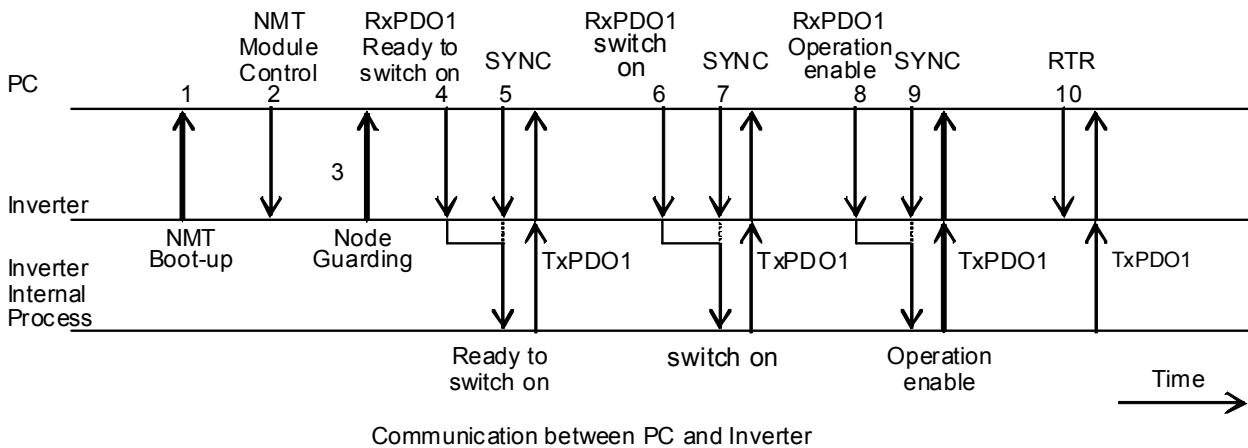

8. Specifications

8.1. Data and operating specification

Item	Specification
Communication Profile	CiA DS301 V4.02 CiA DR 303-3 V1.3 Indicator specification CiA DSP 402 Ver1.1 Drives and motion control device profile, Velocity mode
Communication medium	CAN (ISO 11898)

8.2. CANopen device specification

Item	Specification	Comments
Node-ID	1 ~ 127	Up to 64 node in one segment
Baud rate	20k, 50k, 125k, 250k 500k, 800k, 1M	Factory setting is 125kbps
LED indicator	RUN LED ERR LED	Green LED Red LED
Time stamp	No function	---
SDO	1 SDO server Expedited segment transfer	---
PDO	PDO1 PDO2 PDO3 PDO21	COB-IDs are variable mapping Objects are variable mapping
Translation Type (RPDO)	Synchronous and Asynchronous are supported	---
Translation Type (TPDO)	Acyclic synchronous Cyclic synchronous Synchronous RTR only Asynchronous RTR only Asynchronous, timer trigger	---
HEALTH Heartbeat	1 Producer 1 Consumer	---
Connector	Shielded RJ45 connector	---

8.3. Connecting of CANopen communication option

■ Connector diagram of CAN001Z

Type form	CAN001Z
Connector	2×RJ45

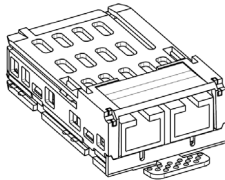

Plug

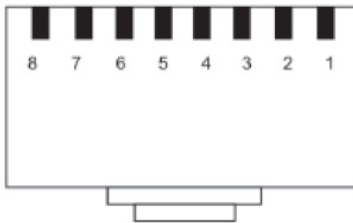

Socket

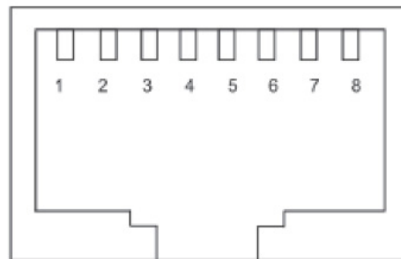

Pin	Signal	Description
1	CAN_H	Isolated from drive (Connected both RJ45 each other)
2	CAN_L	Isolated from drive (Connected both RJ45 each other)
3	CAN_GND	Isolated from drive (Connected both RJ45 each other)
4	NC	-
5	NC	-
6	NC	-
7	NC	-
8	NC	-
Frame	Shield	Earth (through SBP009Z grounding cable)

■ Connector diagram of CAN002Z

Type form	CAN002Z
Connector	9pin D-sub

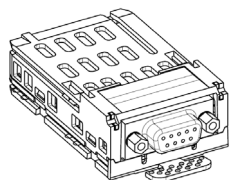

Plug

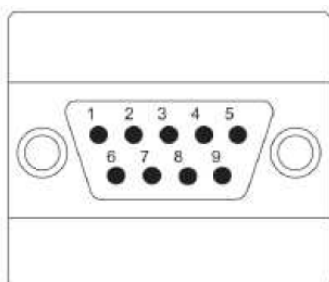

Socket

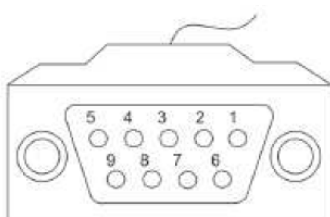

Pin	Signal	Description
1	NC	-
2	CAN_L	Isolated from drive
3	CAN_GND	Isolated from drive
4	NC	-
5	NC	-
6	CAN_GND	Isolated from drive
7	CAN_H	Isolated from drive
8	NC	-
9	NC	-
Frame	Shield	Earth (through SBP009Z grounding cable)

■ Connector diagram of CAN003Z

Type form	CAN003Z
Connector	5 pin open type

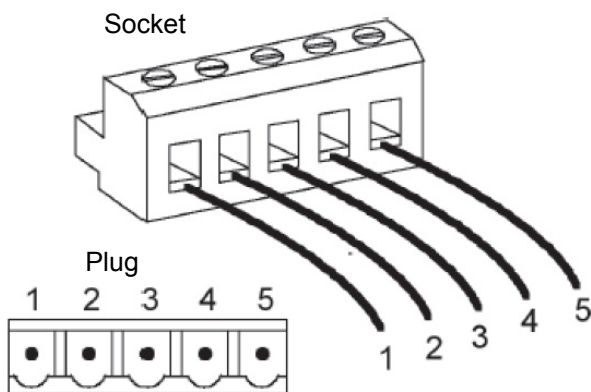
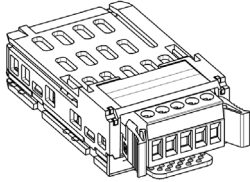

Pin	Signal	Description
1	CAN_GND	Isolated from drive
2	CAN_L	Isolated from drive
3	Shield	Earth (through SBP009Z grounding cable)
4	CAN_H	Isolated from drive
5	NC	-