

# TOSVERT VF-S11

---

## Communications Function Instruction Manual

---

Notice

1. Make sure that this instruction manual is delivered to the end user of the inverter.
2. Read this manual before first using the communications function, and keep it handy as a reference for maintenance and inspections.

\* The contents of this manual are subject to change without notice.

# **Toshiba Schneider Inverter Corporation**

© TOSHIBA SCHNEIDER INVERTER CORPORATION 2004

All rights reserved.



---

## Read first

---

### Safety precautions

---

This manual and labels on the inverter provide very important information that you should bear in mind to use the inverter properly and safely, and also to avoid injury to yourself and other people and damage to property.

Read the safety precautions in the instruction manual for your inverter before reading this manual and strictly follow the safety instructions given.

<b>Notice</b>		Reference
<ul style="list-style-type: none"> <li>◆ Insert an electromagnetic contactor between the inverter and the power supply so that the machine can be stopped without fail from an external controller in case of an emergency.</li> <li>◆ Do not write the same parameter to the EEPROM more than 10,000 times. The life time of EEPROM is approximately 10,000 times.(Some parameters are not limited, please refer to the "9.Parameter data ") When using the TOSHIBA inverter protocol and the data does not need to be records, use P command (the data is written only to RAM).</li> <li>◆ About the handling of the inverter, please follow the instruction manual of the inverter.</li> </ul>	<p>Inverter instruction manual</p> <p>Section 4.2 "Commands"</p>	

# Contents

1.	General outlines of the communications function.....	3
2.	Data transmission specifications.....	4
3.	Communication protocol.....	5
4.	TOSHIBA Inverter Protocol.....	6
4.1.	Data transmission formats.....	8
4.1.1.	Data transmission formats used in ASCII mode.....	8
4.1.2.	Data transmission formats used in binary mode.....	11
4.1.3.	Transmission Format of Block Communication.....	14
4.2.	Commands.....	18
4.3.	Transmission errors.....	21
4.4.	Broadcast communications function.....	22
4.5.	Examples of the use of communication commands.....	24
4.6.	Examples of RS232C communication programs.....	25
5.	MODBUS-RTU protocol.....	30
5.1.	MODBUS-RTU transmission format.....	32
5.1.1.	Read command (03).....	32
5.1.2.	Write command (06).....	33
5.2.	CRC Generation.....	34
5.3.	Error codes.....	34
6.	Inter-drive communication.....	35
6.1.	Speed proportional control.....	38
6.2.	Transmission format for inter-drive communication.....	39
7.	Communications parameters.....	40
7.1.	Communication baud rate( <i>F800</i> ), Parity bit( <i>F801</i> ).....	41
7.2.	Inverter number( <i>F802</i> ).....	41
7.3.	Timer function( <i>F803</i> ).....	42
7.4.	Setting function of communication waiting time ( <i>F805</i> ).....	43
7.5.	Free notes( <i>F880</i> ).....	43
8.	Commands and monitoring from the computer.....	44
8.1.	Communication commands (commands from the computer).....	44
8.2.	Monitoring from the computer.....	47
8.3.	Control of input/output signals from communication.....	53
8.4.	Utilizing panel (LEDs and keys) by communication.....	56
8.4.1.	LED setting by communication.....	56
8.4.2.	Key utilization by communication.....	59
9.	Parameter data.....	60
	Appendix 1 Table of data codes.....	63
	Appendix 2 Response time.....	64
	Appendix 3 Compatibility with the communications function of the VF-S9.....	65
	Appendix 4 Troubleshooting.....	66

# 1. General outlines of the communications function

This manual explains the serial communications interface function provided for the TOSVERT VF-S11 series of industrial inverters.

The TOSVERT VF-S11 series of inverters can be connected to a computer or a controller (hereinafter referred to as the computer) for data communications via RS232C converter (RS2001Z) or RS485 converter (RS4001Z, RS4002Z, RS4003Z). By writing computer programs, you can monitor the operating status of the inverter, control its operation in various ways from the computer, and change and store parameter settings on storage devices.

The communication protocol is preparing the TOSHIBA Inverter Protocol and the MODBUS-RTU protocol. Please choose selection of a protocol with a communication protocol selection parameter (*F829*).

## <Computer link>

By preparing the program (explained later), the following information can be exchanged between the computer (host) and the inverter.

- Monitoring function (used to monitor the operating status of the inverter: Output frequency, current, voltage, etc.)
- Command function (used to issue run, stop and other commands to the inverter)
- Parameter function (used to set parameters and read their settings)

## <Inter-drive communication function>

Master inverter sends the data, that is selected by the parameter, to all the slave inverters on the same network. This function allows a network construction in which a simple synchronous or proportional operation is possible among plural inverters (without the host computer).

As for data communications codes, the TOSVERT VF-S11 series of inverters support the binary (HEX) code, in addition to the JIS (ASCII) code. The communications function is designed on the assumption that the JIS (ASCII) code is used for communications between the inverter and the personal computer, and the binary (HEX) code for communications between the inverter and the microcomputer built into the controller. A communication number is used to access the desired data item.

- \* The smallest unit of information that computers handle is called a "bit (binary digit)," which represents the two numbers in the binary system: 1 or 0. A group of 16 bits is referred to as a "word," which is the basic unit of information the VF-S11 series of inverters use for data communications. One word can handle data items of 0 to FFFFH in hexadecimal notation (or 0 to 65535 in decimal notation).

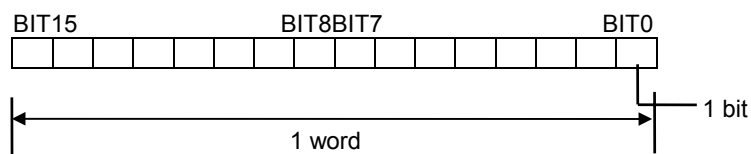

## 2. Data transmission specifications

Items	Specifications
Transmission scheme	Half-duplex
Synchronization scheme	Start-stop synchronization
Communication baud rate	1200/2400/4800/9600*/19200 bps (selectable using a parameter) <sup>*1</sup>
Communication protocol	TOSHIBA Inverter Protocol * / MODBUS-RTU
Character transmission	<ASCII mode> JIS X 0201 8-bit (ASCII) <Binary mode, MODBUS-RTU> Binary codes fixed to 8 bits
Stop bit length	Received by inverter: 1 bit, Sent by inverter: 2 bits <sup>*3</sup>
Error detecting scheme	Parity <sup>*2</sup> : Even */odd/non parity (selectable using a parameter) <sup>*1</sup> , checksum(Toshiba inverter protocol), CRC(MODBUS-RTU)
Character transmission format	11-bit characters <sup>*1</sup> (Stop bit=1, with parity)
Order of bit transmission	Low-order bits transmitted first
Frame length	Variable (to a maximum of 17 bytes)

\*: Standard default setting

\*1: Changes to the communication baud rate and to the parity setting do not take effect until the inverter is turned back on or reset.

\*2: JIS-X-0201 (ANSI)-compliant 8-bit codes are used for all messages transmitted in ASCII mode and vertical (even) parity bits specified by JIS-X-5001 are added to them. These even parity bits can be changed to odd parity bits by changing the parameter setting (a change to the parameter setting does not take effect until the inverter has been reset.)

\*3: Here are the default character transmission formats. (Standard default setting)

Characters received: 11 bits (1 start bit + 8 bits + 1 parity bit + 1 stop bit) ... Standard default setting

START									PARITY	STOP
BIT	BIT0	BIT1	BIT2	BIT3	BIT4	BIT5	BIT6	BIT7	BIT	BIT

The inverter receives **one stop bit**.

(The computer can be set so as to send 1, 1.5 or 2 stop bits.)

Characters sent: 12 bits (1 start bit + 8 bits + 1 parity bit + 2 stop bits) ... Standard default setting

START									PARITY	STOP	STOP
BIT	BIT0	BIT1	BIT2	BIT3	BIT4	BIT5	BIT6	BIT7	BIT	BIT	BIT

The inverter sends **two stop bits**.

(The computer can be set so as to receive 1, 1.5 or 2 stop bits.)

---

## 3. Communication protocol

---

This communication protocol supports the TOSHIBA Inverter Protocol and part of MODBUS-RTU protocol.

Select the desired protocol from in the following communication protocol selection parameters (*F829*).

“Parameter Name *F829*, Communication Number. 0829”

Data Range: 0, 1 (Initial value: 0)

0: TOSHIBA Inverter Protocol (Includes inter-drive communications)

1: MOUBUS-RTU protocol

\* A parameter change is reflected when the inverter is reset, such as in power off.

Note : When using the extension panel (RKP001Z) and the parameter writer (PWU001Z), be certain to set F829="0" : TOSHIBA inverter protocol.

## 4. TOSHIBA Inverter Protocol

Select "TOSHIBA Inverter Protocol" ( $F829=0$ ) in the communication protocol selection parameters. "TOSHIBA Inverter Protocol" ( $F829=0$ ) is set for initial communication protocol selection of shipment setting. (See "3. Communication protocol.")

### ■ Exchange of data between the computer and the inverter

In communications between the computer and the VF-S11 (hereinafter referred to as the inverter), the inverter is always placed in wait states and acts as a slave that operates on a request from the computer. A start code is used to automatically identify the mode in which data is transmitted: ASCII mode or binary mode.

A transmission error will result if the transmission format does not match.

### ■ ASCII mode

- (1) In ASCII mode, the start code is "("
 

The inverter rejects all data items entered invalid the "(" If two or more "(" are entered, the "(" entered last will be valid and all "(" entered before will be ignored. If the "(" is not recognized because of a format error or for any other reason, no error code will be returned since the data is not recognized at all. In such cases, the inverter regards the data received as a transmission error, rejects it and goes back into a start code wait state.
- (2) When an inverter number is added behind the "(" communications will take place only in case of broadcast communication or if the number matches up with that assigned to the inverters. If not, the inverter will go back into a start code wait state.
- (3) The inverter stops receiving data on receipt of the CR (carriage return) code inserted in the designated position.
 

If the size of the data transmitted exceeds the maximum allowable size (17 bytes) or if the CR code cannot be found in the designated position within 0.5 seconds, the inverter will regard the data received as a transmission error and go back into a start code wait state.
- (4) If no communications take place within the time specified using the timer function, the computer will regard it as a communication error and trip the inverter. The timer setting is cleared when the timer is turned on or initialized. For more details, see Section 7.3, "Timer function."
- (5) On executing the command received, the inverter returns data to the computer. For the response time, see Appendix 2, "Response time."



### ■ Binary mode

- (1) In binary mode, the start code is "2FH(/)."  
The inverter rejects all data items entered before the "2FH(/)."  
If two or more "2FH(/)" are entered, the "2FH(/)" entered last will be judged valid and all "2FH(/)" entered before will be ignored.  
If the "2FH(/)" is not recognized because of a format error or for any other reason, no error code will be returned since the data is not recognized at all. In such cases, the inverter regards the data received as a transmission error, rejects it and goes back into a start code wait state.
- (2) If an inverter number is added behind the "2FH(/)," communications will take place only in case of broadcast communication or if the number matches up with that assigned to the inverters. If not, the inverter will go back into a start code wait state.
- (3) The inverter stops receiving data on receipt of a command and the number of bytes of data specified by the command.  
If no command is found in the data received or if the specified number of bytes of data cannot be received within about 0.5 seconds, the inverter will regard the data received as a transmission error and go back into a start code wait state.
- (4) If no communications take place within the time specified using the timer function, the computer will assume that a communication error has occurred and trip the inverter. The timer function is disabled when the inverter is turned on or initialized. For details, see Section 7.3, "Timer function."
- (5) On executing the command received, the inverter returns data to the computer. For the response time, see Appendix 2, "Response time."

### ■ Note

Communication is not possible for about one second after the power is supplied to the inverter until the initial setting is completed. If the control power is shut down due to an instantaneous voltage drop, communication is temporarily interrupted.

## 4.1. Data transmission formats

- Note: The term “trip status” used in this manual includes retry waiting status and trip retention status.

### 4.1.1. Data transmission formats used in ASCII mode

A communication number is used to specify a data item, all data is written in hexadecimal, and JIS-X-0201 (ASCII (ANSI))-compliant transmission characters are used.

- Computer → VF-S11

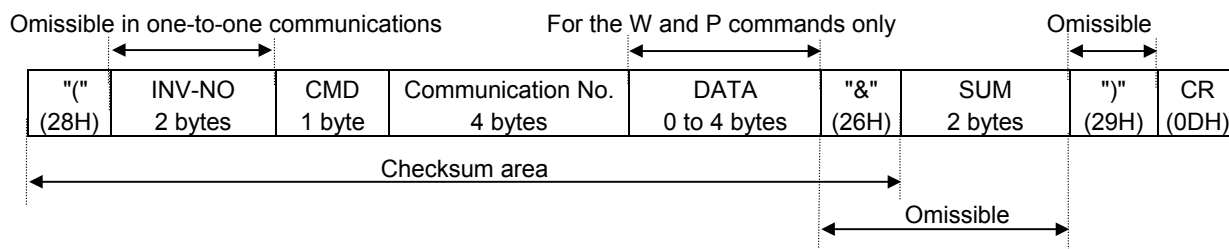

1. "(" (1 byte) : Start code in ASCII mode
2. INV-NO (2 bytes) : Inverter number (Omissible in one-to-one communications) ... 00 (30H, 30h) to 99 (39H, 39h), \*(2AH)  
The command is executed only when the inverter number matches up with that specified using a parameter.  
(When \* is specified in broadcast communications, the inverter number is assumed to match if all numbers except \* match. When \* is specified instead of each digit (two-digit number), all inverters connected are assumed to match.)  
If the inverter number does not match or if the inverter number is of one digit, the data will be judged invalid and no data will be returned.
3. CMD (1 byte) : Command (For details, see the table below.)
4. Communication No.(4 bytes)  
: Communication number (See 11, “Parameter data.”)
5. Data (0 to 4 bytes): Write data (valid for the W and P commands only)
6. "&" (1 byte) : Checksum discrimination code (omissible. When omitting this code, you also need to omit the checksum.)
7. Sum (2 bytes) : Checksum (omissible)  
Add the ASCII-coded value of the last two digits (4 bits/digit) of the sum of a series of bits (ASCII codes) from the start code to the checksum discrimination code.  
Ex.: (R0000&??) CR  
 $28H+52H+30H+30H+30H+30H+26H=160H$   
The last two digits represent the checksum. = 60  
When omitting the checksum, you also need to omit the checksum discrimination code.
8. ")" (1 byte) : Stop code (omissible)
9. CR (1 byte) : Carriage return code

- Details of commands and data

CMD (1 byte)	Write data (0 to 4 bytes) Hexadecimal number
R (52H): RAM read command	No data
W (57H): RAM/EEPROM write command	Write data (0 to FFFF)
P (50H) RAM write command	Write data (0 to FFFF)

■ VF-S11 → computer

At time of broadcast communication, returning of data is not executed, except for the inverters to be returned, when the inverter number is not matched, and the inverter number has only one character.

This is because there will be a risk of that the returned data may be deformed.

• Data returned when data is processed normally (ASCII mode)

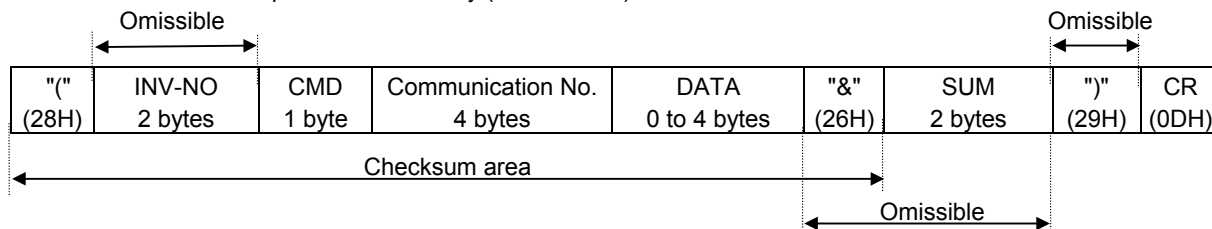

1. "(" (1 byte) : Start code in ASCII mode
2. INV-NO (2 bytes) : Inverter number (omitted if it is not found in the data received) ... 00 (30H, 30H) to 99 (39H, 39H)  
If the inverter number matches up with that specified using a parameter, data will be returned to the computer. In broadcast communications, only the destination inverter (with a number matching up with the smallest effective number) returns data to the computer.  
In broadcast communications, no data is returned from any inverters except the inverter bearing a number that matches up with the smallest effective number.  
Ex.: (\*2R0000) CR -> (02R00000000) CR  
Data is returned from the inverter with the number 2 only, but no data is returned from inverters with the number 12, 22 ....
3. CMD (1 byte) : Command ... The command is also used for a check when an inverter is tripped.  
Under normal conditions... The uppercase letter R, W or P is returned, depending on the command received: R, W or P command.  
When an inverter is tripped... The lowercase letter r, w or p is returned, depending on the command received: R, W or P command.  
(The command received is returned with 20H added to it.)
4. Communication No.(4 bytes) :  
The communication number received is returned.
5. Data (0 to 4 bytes): Data ... The data read in is returned for the R command, while the data received is returned for the W and P commands. If the data received is composed of less than 4 digits, it will be converted into 4-digit data and returned.  
Ex.: (W123412) CR → (W12340012) CR
6. "&" (1 byte) : Checksum discrimination code (omitted if it is not found in the data received)
7. Sum (2 bytes) : Checksum ... Omitted if no checksum discrimination code is found in the data received.  
ASCII-coded value of the last two digits (4 bits/digit) of the sum of a series of bits (ASCII codes) from the start code to the checksum discrimination code.
8. ")" (1 byte) : Stop code (omitted if it is not found in the data received)
9. CR (1 byte) : Carriage return code

• Data returned when data is not processed normally (ASCII mode)

In case an error occurs, communication error command (4EH(N) or 6EH(n)) and the error type number is returned to the computer in addition to the checksum. At time of broadcast communication of the binary mode, returning of data is not executed except for the inverter to be returned (inverter number 00H) and when the inverter number is not matched. This is because there will be a risk that the returned data may be deformed.

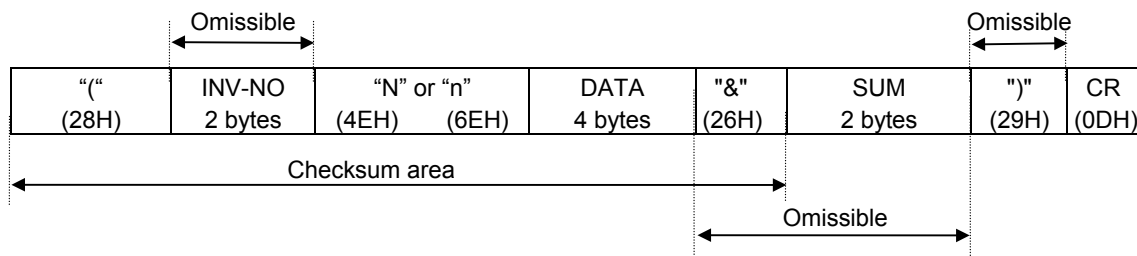

- “ (1 byte) : Start code in ASCII mode
- 1) N or n (1 byte) : Communication error command ... This is also used for the checking of inverter trip.  
 “4EH(N)” for the normal communication and “6EH(n)” during the inverter trip.
- Data (4 bytes) : Error code (0000~0004)
- 0000 ... Impossible to execute (Although communication is established normally, the command cannot be executed because it is to write data into a parameter whose setting cannot be changed during operation (e.g., maximum frequency) or the EEPROM is faulty.)
- 0001 ... Data error (The data is outside the specified range or it is composed of too many digits.)
- 0002 ... Communication number error (There is no communication number that matches.)
- 0003 ... Command error (There is no command that matches.)
- 0004 ... Checksum error (The checksum result differs.)
- ” (1 byte) : Stop code ... This code is omitted if it is not found in the data received.

■ Examples:

- (N0000&5C)<sub>CR</sub>... Impossible to execute (e.g., a change of maximum frequency data during operation)
- (N0001&5D)<sub>CR</sub>... Data error (Data is outside the specified range.)
- (N0002&5E)<sub>CR</sub>... No communication number (There is no communication number that matches.)
- (N0003&5F)<sub>CR</sub>... There is no command that matches. (Commands other than the R, W and P commands)  
 (Ex.: L, S, G, a, b, m, r, t, w ...)
- (N0004&60)<sub>CR</sub>... Checksum error (The checksum result differs.)
- No data returned ... Format error or invalid inverter number  
 (Ex.: A code other than the stop code (“”) (Ex.: ”)”) is entered in the stop code position or the CR code was not found within 0.5 sec.)

## 4.1.2. Data transmission formats used in binary mode

A communication number is used to specify a data item, data is written in hexadecimal form, and data in transmission characters are represented by binary codes (HEX codes).

### ■ Computer → VF-S11 (binary mode)

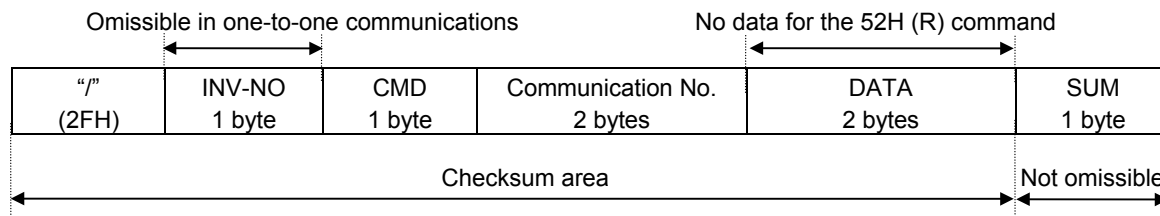

1. 2FH ("2F") (1 byte) : Start code in binary mode
2. INV-NO (2 bytes) : Inverter number (Omissible in one-to-one communications) ... 00H to 3FH ,FFH  
In case the inverter number is other than FFH (broadcast communication), command is executed only when the inverter number coincides with the one designated with the panel. If the inverter number is not matched, it will be judged invalid and the data is not returned.
3. CMD (1 byte) : Command (For details, see the table below.)  
52H (R) command: The size of the data following CMD is fixed to 3 bytes. (Communication number: 2 bytes, checksum: 1 byte)  
57H (W), 50H (P) and 47H (G) commands: The size of the data following CMD is fixed to 5 bytes.  
(Communication number: 2 bytes, data: 2 byte, checksum: 1 byte)  
Any command other than the above is rejected and no error code is returned.
4. Communication No.(2 bytes)  
: Communication number (See 11, "Parameter data.")
5. Data (2 bytes) : 0000H to FFFFH  
57H (W) and 50H (P) commands: Write data (An area check is performed.)  
47H (G) command: Dummy data (e.g., 0000) is needed.  
52H (R) command: Any data is judged invalid. (No data should be added.)
6. Sum (2 bytes) : Checksum (not omissible) 00H to FFH  
Value of the last two digits (1 byte) of the sum of a series of bits (codes) from the start code of the data returned to the data (or to the communication number for the 52H (R) command)  
Ex.: 2F 52 00 ?? ... 2FH+52H+00H+00H=81H  
The last two digits (??) represent the checksum. = 81

### ■ Details of commands and data

CMD (1 byte)	Write data (2 bytes) Hexadecimal number
52H (R): RAM read command	No data
57H (W): RAM/EEPROM write command	Write data (0000H to FFFFH)
50H (P): RAM write command	Write data (0000H to FFFFH)
47H (G): RAM read command (for two-wire networks)	Dummy data (0000H to FFFFH)

■ VF-S11 → computer (binary mode)

At time of broadcast communication of the binary mode, returning of data is not executed except for the inverter to be returned (inverter number 00H) and when the inverter number is not matched. This is because there will be a risk that the returned data may be deformed.

• Data returned when data is processed normally (Binary mode)

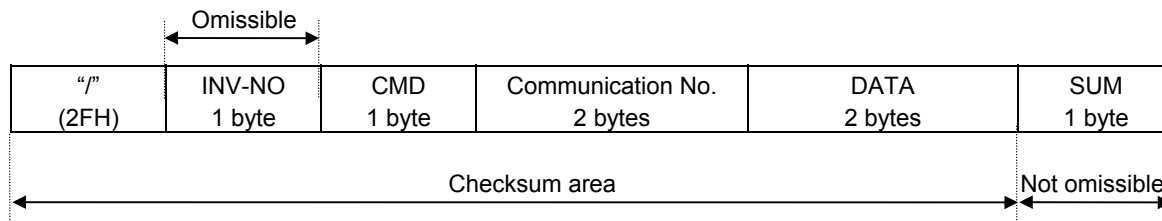

1. 2FH (“f”) (1 byte) : Start code in binary mode
2. INV-NO (2 bytes) : Inverter number... 00H to 3FH (The inverter number is omitted if it is not found in the data received.)  
If the inverter number matches up with that specified from the operation panel, data will be returned from the inverter. If the inverter number does not match, the data will be invalid and no data will be returned.
3. CMD (1 byte) : Command...The command is also used for a check when the inverter is tripped.  
Under normal conditions...52H (R), 47H (G), 57H (W) or 50H (P) is returned, depending on the command received.  
When the inverter is tripped...The lowercase letter 72H (r), 67H (g), 77H (w) or 70H (p) is returned with 20H added to it, depending on the command received.
4. Communication No. (4 bytes)  
: The communication number received is returned.
5. Data (2 bytes) : Data ... 0000H to FFFFFH  
The data read is returned for the 52H (R) and 47H (G) commands, while the data written is returned for the 57H (W) and 50H (P) commands.
6. Sum (1 bytes) : Checksum (not omissible) 00H to FFH  
Value of the last two digits (1 byte) of the sum of a series of bits (codes) from the start code to the data.

## 2) Error Processing (Binary mode)

In case an error occurs, communication error command (4EH(N) or 6EH(n)) and the error type number is returned to the computer in addition to the checksum. At time of broadcast communication of the binary mode, returning of data is not executed except for the inverter to be returned (inverter number 00H) and when the inverter number is not matched. This is because there will be a risk that the returned data may be deformed.

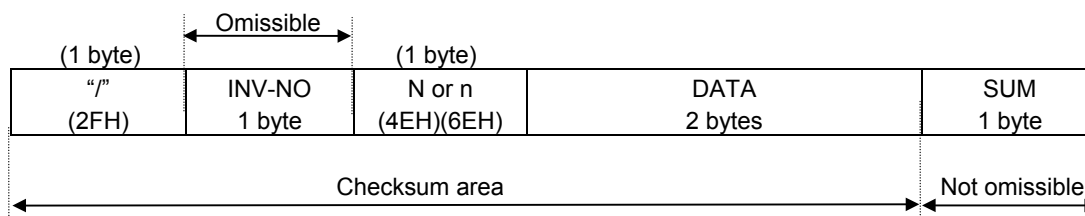

N or n (1 byte) : Communication error command ... This command is also used for a check when the inverter is tripped.  
"4EH (N)" is returned under normal conditions, while "6EH (n)" is returned when the inverter is tripped.

Data (2 bytes) : Error code (0000~0004)  
0000 ... Impossible to execute (Although communication is established normally, the command cannot be executed because it is to write data into a parameter whose setting cannot be changed during operation (e.g., maximum frequency) or the EEPROM is faulty.)  
0001 ... Data error (The data is outside the specified range or it is composed of too many digits.)  
0002 ... Communication number error (There is no communication number that matches.)  
0004 ... Checksum error (The checksum result differs.)

No code returned ... Command error, format error (failure to receive the specified number of bytes within 0.5 seconds, or an parity, overrun or framing error) or the inverter number does not match or an inverter in broadcast communication in the binary mode except for the inverter for data returning (the inverter numbered 00H).

■ Examples:

- 2FH, 4EH, 00H, 00H, 7DH ... Impossible to execute (e.g., a change of maximum frequency data during operation)
- 2FH, 4EH, 00H, 01H, 7EH ... Data setting error (The data specified falls outside the specified range.)
- 2FH, 4EH, 00H, 02H, 7FH ... No communication number (There is no communication number that matches.)
- 2FH, 4EH, 00H, 04H, 81H ... Checksum error (The checksum result differs.)

### 4.1.3. Transmission Format of Block Communication

What is block communication?

Data can be written in and read from several data groups set in one communication by setting the type of data desired for communication in the block communication parameters (*FB70*, *FB71*, *FB75* to *FB79*) in advance. Block communications can save the communication time.

Data is transmitted hexadecimal using the binary (HEX) code transmission characters. "Computer → inverter" is for writing only, while "Inverter → computer" for reply is for reading only.

#### ■ Computer VF-S11 (Block Communications)

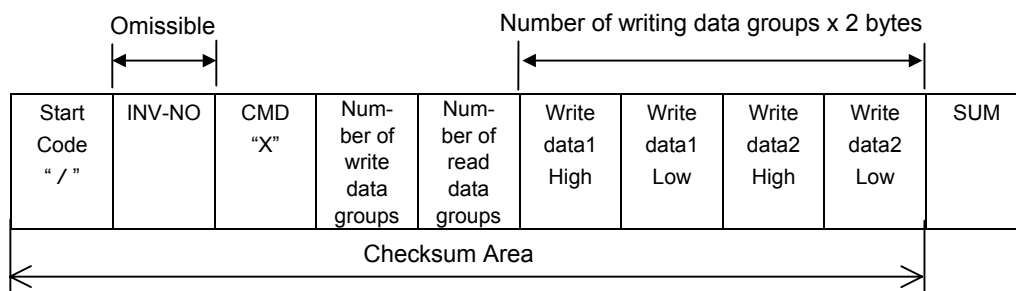

1. 2FH(" / ") (1 byte) : Start code of binary mode
2. INV-NO (1 byte) : Inverter number. (Can be omitted in 1:1 communications): 00H to 3FH, FFH  
Executed only when the inverter number matches the inverter number. Set on the panel, except in FFH (broadcast communication).  
Communication data will be invalidated and data will not be returned either if the inverter number. Does not match.
3. CMD (1 byte) : 'X' (Block communication command)
4. Number of write data groups (1 byte)  
: Specify the number of data groups to be written (00H to 02H).  
If specified outside of the range, data will be treated as a format error and data will not be returned.
5. Number of read data groups (1 byte)  
: Specify the number of data groups to be read (00H to 05H).  
If specified outside of the range, data will be returned as "Number of read data groups = 0" when returned by the inverter.
6. Write data1 (2 bytes)  
: Needed when the number of write data groups is larger than 1.  
Data to be written to the specified parameter selected by *FB70*.  
Dummy data is needed if the number of write data groups is larger than 1 even though (none) is selected for *FB70*.
7. Write data2 (2 bytes)  
: Needed when the number of write data groups is 2.  
Data to be written to the specified parameter selected by *FB71*.  
Dummy data is needed if the number of write data groups is 2 even though (none) is selected for *FB71*.
8. SUM (1 byte) : Checksum (Cannot be omitted) 00H to FFH  
Lower two digits (1 byte) of total sum from start code (SUM value not included)



### ■ Block Write 1, 2

Select data, which is desired to be written in block communications, in Block Communication Write Data 1 and 2 Parameters (*F B 70, F B 71*). This parameter becomes effective when the system is reset, such as when power is turned off. When the setting is completed, turn off and then on the power.

No.	Block Write Data	For data details, see:
0	No selection	-
1	Command 1 (FA00)	"8.1 Command by communication"
2	Command 2 (FA20)	"8.1 Command by communication"
3	Frequency Command Value (FA01)	"8.1 Command by communication"
4	Terminal Board Output Data (FA50)	"8.3 Control of input/put signals from communication"
5	Communication Analog Output (FA51)	"8.3 Control of input/put signals from communication"

\* When "No selection" is specified in the parameters, no data will be written even though write data is specified.

### ■ Block Read 1 to 5

Select read data, which is desired to be read in block communications, in Block Communication Read Data 1 and 5 Parameters (*F B 75 to F B 79*). This parameter becomes effective when the system is reset, such as when power is turned off. When the setting is completed, turn off and then on the power.

No.	Block Read Data	For data details, see:
0	No selection	-
1	Status 1 (FD01)	"8.2 Monitoring from communication"
2	Output Frequency (FD00)	"8.2 Monitoring from communication"
3	Output Current (FE03)	"9. Parameter data"
4	Output Voltage (FE05)	"9. Parameter data"
5	Alarm Information (FC91)	"8.2 Monitoring from communication"
6	PID Feedback Value (FE22)	"9. Parameter data"
7	Input Terminal Board Monitoring (FD06)	"8.3 Control of input/put signals from communication"
8	Output Terminal Board Monitoring (FD07)	"8.3 Control of input/put signals from communication"
9	Analog Monitoring VIA (FE35)	"8.3 Control of input/put signals from communication"
10	Analog Monitoring VIB (FE36)	"8.3 Control of input/put signals from communication"

\* Output current (FE03), output voltage (FE05) and PID feedback value (FE22) will become hold data during a trip. Otherwise, real-time data appears.

\* "0000" will be returned as dummy data, if "0 (No selection)" is selected for the parameter and "read" is specified.

## ■ VF-S11 → Computer

At time of broadcast communication of the binary mode, returning of data is not executed except for the inverter to be returned (inverter number 00H) and when the inverter number is not matched. This is because there will be a risk that the returned data may be deformed.

### 1) Normal processing

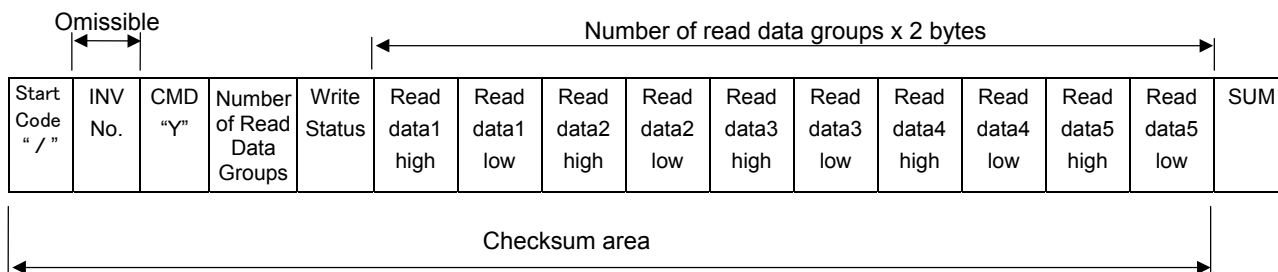

1. 2FH "/" (1 byte) : Start code in binary mode
2. INV-NO (1Byte) : Inverter number 00H to 3FH  
If the inverter number matches up with that specified from the operation panel, data will be returned from the inverter. If the inverter number does not match, the data will be judged invalid and no data will be returned.  
Communication data will be invalidated and data will not be returned either if the inverter number does not match. (Inverter number is considered matched if it is omitted during reception)
3. CMD(1Byte) : 'Y' (Block communication command [monitoring])  
Lowercase letter 'y' during an inverter trip, including standing by for retrying and during a trip.
4. Number of read data groups (1 byte) : Return the number of data groups to be read (00H to 05H).
5. Write status (1 byte) : Return 00H to 03H.  
\* Failing to write in the specified parameter in the number of write data groups, set "1" in the corresponding bit for the parameter failed to write. (See below.)

Bit Position	7	6	5	4	3	2	1	0
Data Type	-						FB11	FB10

6. Read data1 - 5 (2 bytes) : Return according to the number of read data groups. "0000H" is returned as dummy data if "0" is selected as a parameter.  
Read data1: Data selected by FB75. Read data2: Data selected by FB76.  
Read data3: Data selected by FB77. Read data4: Data selected by FB78.  
Read data5: Data selected by FB79.
7. SUM(1Byte) : Checksum (Cannot be omitted) 00H to FFH  
Lower two digits (1 byte) of total sum from start code of return data to read data.

### ■ Example

(When set as follows: FB70 = 1 (Command 1), FB71 = 3 (frequency command value),  
FB75 = 1 (status), FB76 = 2 (output frequency), FB77 = 3 (output current), FB78 = 4 (output voltage) and  
FB79 = 5 (alarm))

Computer → Inverter : 2F 58 02 05 C4 00 17 70 D9

Inverter → Computer : 2F 59 05 03 00 00 00 00 00 00 00 00 00 90 (When parameter is not set)

Inverter → Computer : 2F 59 05 00 40 00 00 00 00 00 00 00 00 CD CD (When parameter is set)

Inverter → Computer : 2F 59 05 00 64 00 17 70 1A 8A 24 FD 00 00 3D (During operation at 60Hz)

## 2) Error Processing (Binary mode)

In case an error occurs, communication error command (4EH(N) or 6EH(n)) and the error type number is returned to the computer in addition to the checksum. At time of broadcast communication of the binary mode, returning of data is not executed except for the inverter to be returned (inverter number 00H) and when the inverter number is not matched. This is because there will be a risk that the returned data may be deformed.

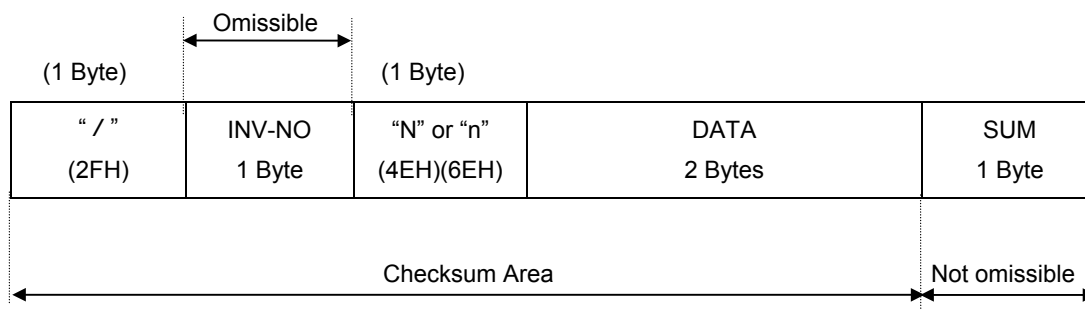

“N” or “n” (1 byte) : Communication error command. Also for check during an inverter trip (includes standing by for retrying and trip holding). “4EH (N)” when normal, “6EH (n)” during an inverter trip.

DATA (2 bytes) : Error code (0004)  
 0004 : Checksum error (The checksum does not match)  
 No return : Command error, format error (specified number of bytes is not received in 1sec, or parity error, overrun error or framing error), inverter number mismatch, and inverter number other than 00H in broadcast communication.

#### ■ Examples

Computer → Inverter : 2F 58 02 05 C4 00 17 70 D8

Inverter → Computer : 2F 4E 00 04 81 ... Checksum error

## 4.2. Commands

Here are the communication commands available.

Command	Function
R command	Reads the data with the specified communication number.
W command	Writes the data with the specified communication number. (RAM and EEPROM).
P command	Writes the data with the specified communication number. (RAM).
G command	Reads the data with the specified communication number. (For binary mode only. Dummy data is required for this command.)
X command	Block communication (Computer -> Inverter)
Y command	Block communication (Inverter -> Computer)

### ■ W (57H) (RAM<sup>\*1</sup>/EEPROM<sup>\*2</sup> write)

This command is used to write new data into the parameter specified using its communication number. It writes data into the RAM and EEPROM. For parameters whose settings cannot be stored in the EEPROM (e.g., parameter with the communication number FA00), the W (57H) command writes data into the RAM only. It cannot be used to write data into read-only parameters (e.g., parameter with the communication number FD?? or FE??).

Each time an attempt to write data is made, the inverter checks if the data falls within the specified range. If this check reveals that the data falls outside the specified range, the inverter will reject it and return an error code.

- Ex.: Setting the deceleration time (communication number: 0010) to 10 sec.

<ASCII mode>

Computer → Inverter

(W00100064)CR

Inverter → Computer

(W00100064)CR

...(10÷0.1=100=0064H)

CR: Carriage return

<Binary mode>

Computer → Inverter

2F 57 00 10 00 64 FA

Inverter → Computer

2F 57 00 10 00 64 FA

...(10÷0.1=100=0064H)

## Notice

- ◆ Do not write the same parameter to the EEPROM more than 10,000 times. The life time of EEPROM is approximately 10,000 times. (Some parameters are not limited, please refer to the "9.Parameter data ")  
The lifetime of EEPROM is approximately 10,000 times. When using the TOSHIBA inverter protocol and the data does not need to be records, use P command (the data is written only to RAM).

### ■ Explanation of terms

\*1: The RAM is used to temporarily store inverter operation data. Data stored in the RAM is cleared when the inverter is turned off, and data stored in the EEPROM is copied to the RAM when the inverter is turned back on.

\*2: The EEPROM is used to store inverter operation parameter settings, and so on. Data stored in the EEPROM is retained even after the power is turned off, and it is copied to the RAM when the inverter is turned on or reset.

## ■ P (50H) (RAM\*1 write)

This command is used to rewrite data into the parameter specified using a communication number. It writes data into the RAM only. It cannot be used to write data into any read-only parameters. Each time an attempt to write data is made the inverter checks whether the data falls within the specified range. If this check reveals that the data falls outside the range, the inverter will reject it and return an error code.

- Ex.: Entering the emergency stop command (communication number: FA00) from the computer

<ASCII mode>

<u>Computer → Inverter</u>	<u>Inverter → Computer</u>	
(PFA009000)CR	(PFA009000)CR	...Command priority, emergency stop command

<Binary mode>

<u>Computer → Inverter</u>	<u>Inverter → Computer</u>
2F 50 FA 00 90 00 09	2F 50 FA 00 90 00 09

## ■ R (52H) (Data read)

This command is used to read the setting of the parameter specified using a communication number. (When multiple inverters are operated in binary mode via RS485 converter connected to a two-wire line, the execution of the R command could result in a communication error. To avoid this, use the G command in binary mode when inverters are connected to a two-wire line.)

- Ex.: Monitoring the electric current (communication number: FE03)

<ASCII mode>

<u>Computer → Inverter</u>	<u>Inverter → Computer</u>	
(RFE03)CR	(RFE03077B)CR	...Current: 1915 / 100 = 19.15%

<Binary mode>

<u>Computer → Inverter</u>	<u>Inverter → Computer</u>
2F 52 FE 03 82	2F 52 FE 03 07 7B 04

## Notice

When multiple inverters are operated in binary mode via RS485 converter connected to a two-wire line, use the G command to read data.
---

## ■ G (47H) (Data read)

This command is used to read the parameter data specified using a communication number. To send this command to an inverter with two-wire type RS485 network, 2bytes of dummy data are needed. This command is available only in binary mode.

- Ex.: Monitoring the electric current (communication number: FE03)

<u>Computer → Inverter</u>	<u>Inverter → Computer</u>
2F 47 FE 03 00 00 77	2F 47 FE 03 07 7B F9

\* In this example, the data 00H sent from the computer to the inverter is dummy data.

## ■ S (53 H)/ s (73 H) Inter-drive communication command(RAM\*1 Write)

This command is for using frequency command values in % (1 = 0.01%), instead of in Hz, and is for synchronous-proportional operation in inter-drive communication. This command can also be used in ordinary computer link communications.

When writing in the frequency command (FA01) is enabled and a parameter other than it is specified, a communication number error will result. Data is written in the RAMs only and at this time the data check such as an upper limit and lower limit checking is not carried out.

Data is not returned from the inverters while this command is used. This command can be used only in the binary mode.

For the details of the format, see "6.2 Transmission format for inter-drive communication."

Use (%) as the unit for frequency command values specified by the command S, instead of (Hz), and the receiving side converts units for frequency values to "Hz" in accordance with the point conversion parameter. The conversion formula is shown below.

Frequency command value (Hz) =

$$\frac{\text{Point 2 frequency (F813)} - \text{Point 1 frequency (F812)}}{\text{Point 2 (F814)} - \text{Point 1 (F811)}} \times (\text{Frequency command value (\%)}) - \text{Point 1 (F811)} + \text{Point 1 frequency (F812)}$$

When Command "s" (lowercase letter) is received, the slave side judges that the master side is tripped and operates in accordance with the inter-drive communication parameter (F805).

For detail, see "7. Communication parameters".

- Examples: 50% frequency command

(If maximum frequency = Frequency for operation at 80Hz = 40Hz: 50% = 5000d = 1388H)

<Binary mode>

Master inverter → Slave inverter

2F 53 FA 01 13 88 18

Slave inverter → Master inverter

No return

## ■ X(58H)/Y (59H) (Block Communication Command)

Data selected in the block communication write parameters (F870, F871) is written in the RAMs. When returning data, data selected in block communication read parameters (F875 to F879) is read and is returned.

- Examples: 60Hz operation command from communication and monitoring (Monitoring when already operating at 60Hz)

(Parameter Setting: F870 = 1, F871 = 3, F875 = 1, F876 = 2, F877 = 3, F878 = 4, F879 = 5)

<Binary mode>

Computer → Inverter

2F 58 02 05 C4 00 17 70 D9

Inverter → Computer

2F 59 05 00 64 00 17 70 1A 8A 24 FD 00 00 3D

## 4.3. Transmission errors

### ■ Table of error codes

Error name	Description	Error code
Impossible to execute	The command is impossible to execute, though communication was established normally. 1 Writing data into a parameter whose setting cannot be changed during operation (e.g., maximum frequency) <sup>*1</sup> 2 Writing data into a parameter while “ $\text{LUP}$ ” is in progress 3 The maintenance command is issued. <sup>*2</sup>	0000
Data error	Invalid data is specified.	0001
Communication number error	There is no communication number that matches. Ex.: In the case of (R0))) CR, 0))) is recognized as a communication number.	0002
Command error	The command specified does not exist.	0003 (ASCII mode) No code returned (Binary mode)
Checksum error	The Checksum does not match.	0004
Format error	The data transmission format does not match. 1 One-digit inverter number (ASCII mode) 2 The CR code is found in the designated position. (ASCII mode) Ex.: Communication number of 4 digit or less. In the case of (R11) CR, 11) CR is recognized as a communication number and the CR code is not recognized, with the result that a format error occurs. 3 A code other than the stop code (“ $\text{”}$ ”) is entered in the stop code position. 4 The specified number of bytes of data are not received within 0.5 sec.	No code returned
Receiving error	A parity, overrun or framing error has occurred. <sup>*3</sup>	No code returned

\*1: For parameters whose settings cannot be changed during operation, see 11.1, Table of parameters.”

\*2: In binary mode, no data will be returned if a command error occurs. When the maintenance command (M) is issued, an impossible-to-execute error occurs and an error code is returned.

\*3: Parity error : The parity does not match.

Overrun error : A new data item is entered while the data is being read.

Framing error : The stop bit is placed in the wrong position.

\* For the errors with “no code returned” in the above table, no error code is returned to avoid a data crash.

If no response is received, the computer side recognizes that a communication error has occurred. Retry after a lapse of some time.

\* If the inverter number does not match, no processing will be carried out and no data will be returned, though it is not regarded as an error.

## 4.4. Broadcast communications function

Broadcast communication function can transmit the command (write the data) to multiple inverters by one communication. Only the write (W, P) command is valid and the read (R, G) command is invalid. The inverters subject to the broadcast communication are the same to the independent communication; 0 to 99 (00H - 63H) in the ASCII mode, and 0 to 63 (00H - 3FH) in the binary mode.

To avoid data deforming, the inverters to return data will be limited. A RS485 communication converter unit (RS4001Z, RS4002Z or RS4003Z) will be needed to control multiple inverters on the network.

### ■ "Overall" broadcast communications (ASCII mode / Binary mode)

#### - ASCII Mode

If you enter two asterisks (\*\*) in the inverter number position of the data transmission format, the computer will send the data simultaneously to all inverters (with an inverter number between 0 and 99 (00 to 63H)) on the network.

#### - Binary Mode

To put "FF" to the specified place of the inverter number in the communication format validates the broadcast communication and the command is transmitted to all the applicable inverters in the network (inverter numbers from 0 to 63 (00 to 3FH)).

<Inverter that returns data to the computer>

Data is returned from the inverter bearing the inverter number 00 only.

If you do not want inverters to return data, do not assign the number 00 to any inverter on the network.

### ■ "Group" broadcast communications (ASCII mode only)

If you put "\*" in the inverter number position of the data transmission format, data will be sent simultaneously to all inverters bearing a number whose digit in the one's place in decimal notation is "0".

If you put "?" in the inverter number position of the data transmission format, the data will be sent simultaneously to all inverters bearing a number whose digit in the ten's place in decimal notation is "0".

("?": Any number between 0 and 9.)

<Inverter that returns data to the computer>

Data is returned only from the inverter bearing the smallest number in the same group of inverters (i.e., inverter whose number in the position of "\*" is 0).

If you do not want inverters to return data to the computer, do not assign a number having a 0 in the position of "\*" to any inverter on the network.)

### ■ Examples of broadcast communications

Ex: Set the frequency setting for communication to 60Hz.

#### 1 Host computer → Multiple inverters: broadcast communications (ASCII Mode)

Example of transmission of data from host computer to inverter: (\*\*PFA011770)<sub>CR</sub>

Example of data returned from inverter to host computer: (00PFA011770)<sub>CR</sub>

Data is returned from the inverter numbered 00 only, while commands are issued to all inverters connected to the network.

#### 2 Host computer → A specific group of inverters: group communications (ASCII Mode)

Example of transmission of data from host computer to inverters: (\*9PFA011770)<sub>CR</sub>

Example of data returned from inverter to host computer: (09PFA011770)<sub>CR</sub>

Data is returned only the inverter numbered 09 only, while commands are issued to a maximum of 10 inverters bearing the number 09, 19, 29, 39, ... or 99.

#### 3 Host computer → Multiple inverters: broadcast communications (Binary Mode)

Example of transmission of data from host computer to inverters: 2F FF 50 FA 01 17 70 00

Example of data returned from inverter to host computer: 2F 00 50 FA 01 17 70 01

Returning is possible only for the inverter that has the number 00, and the command is transmitted to all the applicable inverter connected in the network.



• **An example of system configuration (schematic diagram)**

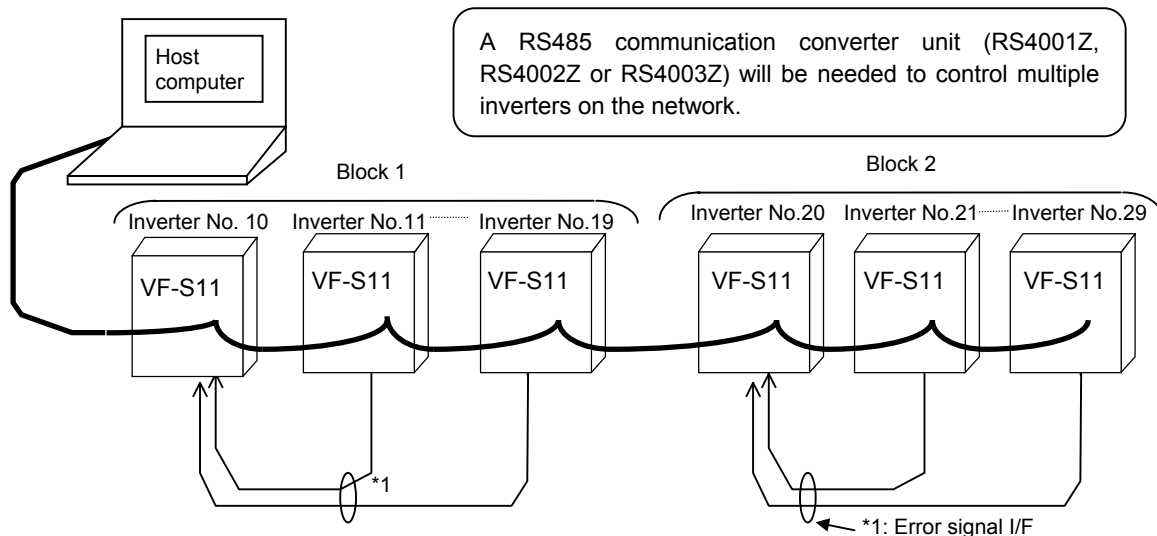

In broadcast communications, only the representative inverter in each block returns data to the host computer. However, you can make the representative inverter in each block report the occurrence of a problem in the block. To do so, follow these steps.

Set the timer function so that, if a time-out occurs, the inverter will trip (Ex.:  $F 8 0 3 = 3$  (sec)), set the output terminal selection parameter (FL) so that trip information will be output through the output terminal ( $F 1 3 2 = 1 0$ ), and set the input terminal selection parameter (F) of the representative inverter in each block to "external input trip (emergency stop)" ( $F 1 1 1 = 1 1$ ). Then, connect the input terminal (F) of the representative inverter to the FL terminal of each of the other inverters in the same block. In this setting, if an inverter trips, the representative inverter will come to an emergency stop, and as a result it will report the occurrence of a problem in its block to the computer. (If the representative inverter returns a lowercase letter in response to a command from the computer, the computer will judge that a problem has arisen in an inverter.) To examine details on the problem that has arisen, the host computer accesses each individual inverter, specifying its communication number. To make the computer issue a command to all inverters in block 1 or block 2 shown in the figure above, specify "1\*" or "2\*", respectively. In this system, inverter No. 10 will return data to the computer if a problem arises in block 1, or inverter No. 20 if a problem arises in block 2. For overall broadcast communications, specify "\*\*\*", in which case the inverter with the communication number "00" will return data to the computer.

In this example, if you want the computer to maintain communications without bringing a representative inverter to an emergency stop, set its input terminal selection parameter to "disabled" ( $F 1 1 1 = 0$ ) but not to "external input trip (emergency stop)." This setting causes the host computer to check the setting of the input terminal information parameter (communication number: FE06) of the representative inverter, and as a result enables the computer to detect the occurrence of a problem.

**CAUTION:**

Data from inverters will be deformed if inverters of the same number are connected on the network. Never assign same single numbers to inverters on the network.

## 4.5. Examples of the use of communication commands

Here are some examples of the use of communications commands provided for the VF-S11 series of inverters.

Inverter numbers and checksum used in ASCII mode are omitted from these examples.

### ■ Examples of communications

- To run the motor in forward direction with the frequency set to 60 Hz from the computer

<ASCII mode>

<u>Computer → Inverter</u>	<u>Inverter → Computer</u>	
(PFA011770)CR	(PFA011770)CR	...Set the operation frequency to 60 Hz. (60 / 0.01 Hz = 6000 = 1770H)
(PFA00C400)CR	(PFA00C400)CR	...Set to "forward run" with commands and frequency instruction from the computer enabled.

<Binary mode>

<u>Computer → Inverter</u>	<u>Inverter → Computer</u>
2F 50 FA 01 17 70 01	2F 50 FA 01 17 70 01
2F 50 FA 00 C4 00 3D	2F 50 FA 00 C4 00 3D

- To monitor the operation frequency (during 60 Hz operation)

<ASCII mode>

<u>Computer → Inverter</u>	<u>Inverter → Computer</u>	
(RFD00)CR	(RFD001770)CR	...Set the operation frequency to 60 Hz. (60÷0.01Hz=6000=1770H)

<Binary mode>

<u>Computer → Inverter</u>	<u>Inverter → Computer</u>
2F 52 FD 00 7E	2F 52 FD 00 17 70 05

- To monitor the status of the inverter

<ASCII mode>

<u>Computer → Inverter</u>	<u>Inverter → Computer</u>	
(RFD01)CR	(rFD010003)CR	...For details on statuses, see 8.2 "Monitoring from the computer." (Stop status, FL output status, trip status (r command))

<Binary mode>

<u>Computer → Inverter</u>	<u>Inverter → Computer</u>
2F 52 FD 01 7F	2F 72 FD 01 00 03 A2

- To check the trip code (when the inverter is tripped because of  $E r r 5$ )

...For details on trip codes, see "Trip code monitor" in 8.2, "Monitoring from the computer." (18H = 24d " $E r r 5$ " trip status)

<ASCII mode>

<u>Computer → Inverter</u>	<u>Inverter → Computer</u>
(RFC90)CR	(rFC900018)CR

<Binary mode>

<u>Computer → Inverter</u>	<u>Inverter → Computer</u>
2F 52 FC 90 0D	2F 72 FC 90 00 18 45

## 4.6. Examples of RS232C communication programs

Ex. 1: BASIC program for monitoring the operation frequency continuously (RS232C, ASCII mode)  
(Toshiba version of Advanced BASIC-86 Ver. 3.01.05J)

◇ Monitoring the operation frequency continuously

1) Examples of programs

10 OPEN "COM1:9600,E,8,1" AS #1	---	9600 baud, even parity, 8-bit length, 1 stop bit
20 A\$="FE00"	---	Specifies the communication number for monitoring the operation frequency.
30 PRINT #1, "("+R"+A\$+)"	---	Transmits data to the inverter. Note: The carriage return code is added automatically.
40 INPUT#1,B\$	---	Receives data returned from the inverter.
50 AAA\$="&H"+MID\$(B\$,7,4)	---	Extracts only data items from the data returned.
60 F\$=LEFT\$(STR\$(VAL(AAA\$)/100),6)	---	Converts data into decimal form.
70 PRINT " Operation frequency =";F\$+"Hz"	---	Displays the operation frequency.
80 GOTO 20	---	Repeats.

2) Examples of program execution results (stop command issued during 80 Hz operation)

```
Operation frequency = 80 Hz ...
Operation frequency = 79.95Hz
      :
      :
Operation frequency = 0Hz
```

Ex. 2: BASIC program for executing an input command with checksum (RS232C, ASCII mode)  
(Toshiba version of Advanced BASIC-86 Ver. 3.01.05J)

◇ Checking if the maximum frequency setting has been changed correctly

1) Examples of programs

<pre> 10 OPEN "COM1:9600,E,8,1" AS #1 20 INPUT"Send Data=";A\$ 30 S\$="+A\$+"&amp;" 40 S=0 50 L=LEN(S\$) 60 FOR I=1 TO L 70 S=S+ASC(MID\$(S\$,I,1)) 80 NEXT I 90 CHS\$=RIGHT\$(HEX\$(S),2) 100 PRINT #1,""+A\$+"&amp;"+"CHS\$+"  110 INPUT #1,B\$ 120 PRINT "Receive data=" ;B\$ 130 GOTO 20 </pre>	<pre> --- 9600 baud, even parity, 8-bit length, 1 stop bit --- Reads in data to be sent to the inverter. --- Adds "(" and "&amp;" to the read data in.  Calculates the number of bits (checksum).  --- Sends the data including the checksum result to the inverter. --- Receives data returned from the inverter. --- Displays the data received. --- Repeats. </pre>
---	--

2) Examples of program execution results

<pre> Send Data=? R0011 Receive Data= (R00111F40&amp;3D) Send Data=? W00111770  Receive Data= (W00111770&amp;36) Send Data=? R0011 Receive Data= (R00111770&amp;31) </pre>	<pre> --- Reads the maximum frequency (0011). --- 1F40 (Maximum frequency: 80 Hz) --- Changes the maximum frequency to 60 Hz (1770).  --- Reads the maximum frequency (0011). --- 1770 (Maximum frequency: 60 Hz) </pre>
--	--

Ex. 3 BASIC program for communication tests (RS232C, ASCII mode)  
 (Toshiba version of Advanced BASIC-86 Ver. 3.01.05J)

◇ Accessing a parameter (with error code.)

1) Examples of programs

```

100 INPUT "Baud rate=9600/4800/2400/1200";SPEED$
                                     ---- Selects a baud rate.
110 INPUT "Parity=even(E)/odd(O)";PARITY$
                                     ---- Selects parity.
120 OPEN "COM1:"+SPEED$+", "+PARITY$+",8,1"AS #1
130 INPUT "Send data";B$             ---- Enters a command.
140 PRINT #1,B$
150 C$=""
160 T=TIMER
170 COUNT=(TIMER-T)
180 IF COUNT >3 THEN 270
190 IF COUNT <0 THEN T=TIMER        ---- Prevents an increase in the number of digits.
200 IF LOC(1)= 0 THEN A$="":GOTO 220
210 A$=INPUT$(1,#1)
220 IF A$ <>CHR$(13) THEN 240        ---- Carriage return
230 GOTO 290                         (CR) to finish reading in.
240 IF A$="" THEN 160
250 C$=C$+A$
260 GOTO 160
270 COLOR @0,7:PRINT "!!! There is no data to return. !!! ";COLOR @7,0:PRINT
280 GOTO 130                          ---- Repeats.
290 PRINT A$;
300 C$=C$+A$
310 PRINT "Return data=";c$;
320 GOTO 130                          ---- Repeats.

```

2) Examples of program execution results (In this example, the inverter number is 00.)

```

Baud rate=9600/4800/2400? 9600      ---- Selects 9600 baud.
Parity=even(E)/odd(O)? E             ---- Select E (even parity).
Send data? (00R0011)                 ---- Carries out test communications.
Return data= (00R00111770)
Send data? ()                         ---- Error
!!! There is no data to return. !!!   ---- No data is returned.
Send data? (R0011)
Return data= (R00111770)
Send data?
:
:

```

Ex. 4 A VisualBaisc program for the ASCII mode communication  
(VisualBaisc is the registered trademark of the U.S. microsoft company.)

◇ Accessing a parameter

1) Sample program executive example (Monitor of the output frequency (FD00))

Transmission and reception of the optional data like in the following example can be done by doing "the arrangement of the form control" of the explanation and "the description of the code" with mentioning later.

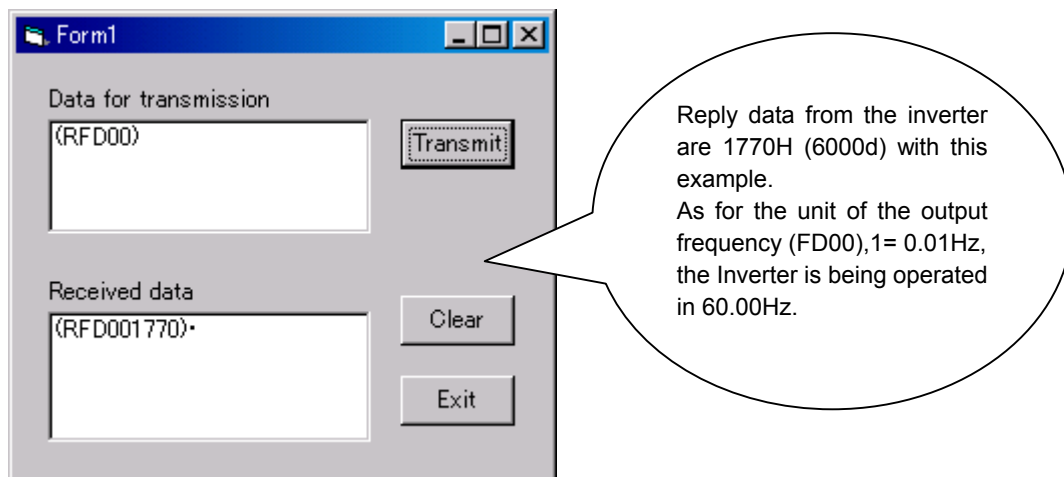

2)Arrangement of the control on the form

Two TextBox, two Labels , three CommandButton and one MsComm are arranged on the form as follows.

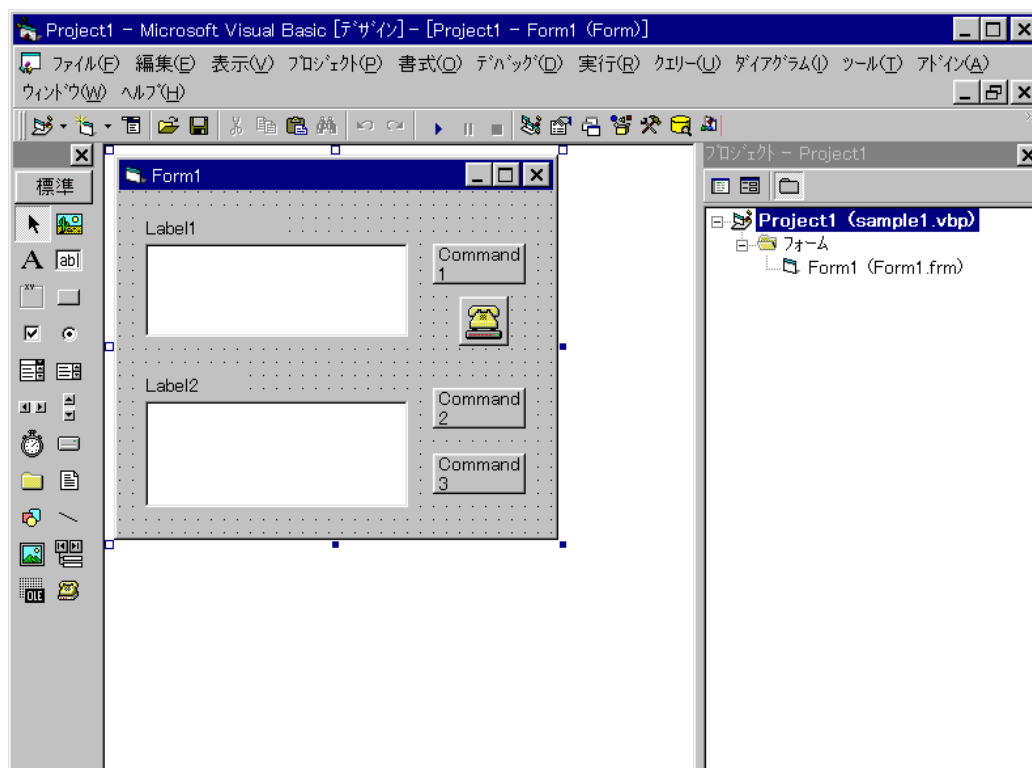

## 3)The description of the code

```

Private Sub Form_Load()
    Form1.Show

    *****
    ' Setting the labels (Initialization)
    *****
        Label1.Caption = "Data for transmission"
        Label2.Caption = "Received data"
        Command1.Caption = "Transmit"
        Command2.Caption = "Clear"
        Command3.Caption = "Exit"

    *****
    ' Setup of communication (Initialization)
    *****
        MSComm1.RThreshold = 0
        MSComm1.InputLen = 1
        MSComm1.CommPort = 1
        MSComm1.InBufferCount = 0
        MSComm1.OutBufferCount = 0
        Form1.MSComm1.Settings = "9600,E,8,1"
        Form1.MSComm1.InputMode = comInputModeText

    *****
    ' A serial port is opened. (Initialization)
    *****
        If False = MSComm1.PortOpen Then
            MSComm1.PortOpen = True
        End If

    *****
    ' Data are received.
    *****
        Do
            dummy = DoEvents()
            If MSComm1.InBufferCount Then
                Text1.Text = Text1.Text & MSComm1.Input
            End If
        Loop
    End Sub

    *****
    ' The contents of the text box are transmitted.
    *****
    Private Sub Command1_Click()
        MSComm1.Output = Text2.Text & Chr(13)
    End Sub

    *****
    'The contents of the text box are removed.
    *****
    Private Sub Command2_Click()
        Text2.Text = ""
        Text1.Text = ""
    End Sub

    *****
    'A serial port is closed, end
    *****
    Private Sub Command3_Click()
        If True = MSComm1.PortOpen Then
            MSComm1.PortOpen = False
        End If
    End Sub
End Sub

```

## 5. MODBUS-RTU protocol

The MODBUS-RTU protocol of VF-S11 supports only part of the MODBUS-RTU protocol. Only two commands are supported, "03: Multiple data read (limited only to two bytes)" and "06: Word writes." All data will be binary codes.

### ■ Parameter Setting

#### • Protocol Selection (*F829*)

Select "MODBUS-RTU protocol (*F829 = 1*) in the communication selection parameters. "TO-SHIBA Inverter Protocol" (*F829=0*) is set for communication protocol selection in initial shipment setting. (See "3. Communication protocol.")

\* Caution when selecting MODBUS-RTU protocol

The extension panel (RKP001Z) and parameter writer (PWU001Z), these options cannot be used. Note that Parameter Numbers. *F805*, *F806*, *F870*, *F871* and *F875* to *F879* do not function.

#### • Inverter Number (*F802*)

Inverter numbers. 0 to 247 can be specified in MODBUS-RTU. "0" is allocated to broadcast communication (no return). Set between 1 and 247.

<Related Parameter: Change and set as necessary>

*F800* : Communication baud rate

*F801* : Parity

*F803* : Communication error trip time

### ■ Timing of Message from Host

MODBUS-RTU sends and receives binary data without a frame synchronization header character and defines the frame synchronizing system to recognize the start of a frame by no-data time. MODBUS-RTU initializes frame information and decides the data that is first received subsequently as the first byte of a frame if data is not communicated within a time for 3.5 bytes, including the start and stop bits, at the transmission speed of the on-going communication while standing by for data reception. If a frame is being received before no-data time for 3.5 bytes, this frame will be aborted. Be sure to provide more than 3.5 bytes for data send interval.

Send data so that the time between characters will not be spaced for more than 1.5 bytes. Otherwise, MODBUS-RTU will sometimes recognize it as a start of data.

In the case of data to other stations, messages from the host and responses from other stations are also received. A wait time for 3.5 bytes is needed before starting transmission after own station completes reception when sending a response to recognize a frame start at this time.



## ■ Data Exchange with Inverters

---

The inverters are always ready to receive messages and perform slave operation in response to computer requests.

A transmission error will result if the transmission format does not match. The inverters will not respond if a framing error, parity error, CRC error or an inverter number mismatch occurs.

If no response is received, the computer side recognizes that a communication error has occurred. Transmit data again.

(1) In case spacing for more than 3.5 bytes are provided before characters, all data immediately preceding it will be aborted. Data will sometimes be aborted if spacing for 1.5 bytes or more is provided between characters.

(2) Communications will be effective only when inverter numbers match or the communication mode is broadcast communications. No response will be made if inverter numbers do not match.

(3) Message reception will end if spacing for more than 3.5 bytes are provided at the end of characters.

(4) If no communications take place within the time specified using the timer function, the computer will assume that a communication error has occurred and trip the inverter. The timer function is disabled when the inverter is turned on or initialized. For details, see Section 7.3, "Timer function."

(5) On executing the command received, the inverter returns data to the computer. For the response time, see Appendix 2, "Response time."

### ■ Caution:

Communication is not possible for about one second after the power is supplied to the inverter until the initial setting is completed. If the control power is shut down due to an instantaneous voltage drop, communication is temporarily interrupted.

## 5.1. MODBUS-RTU transmission format

MODBUS-RTU sends and receives binary data without a frame-synchronizing start code and defines the blank time to recognize the start of a frame. MODBUS-RTU decides the data that is first received subsequently as the first byte of a frame after a blank time for 3.5 bytes at the on-going communication speed.

### 5.1.1. Read command (03)

- Computer → VF-S11 \*The text size is 8 bytes fixed.

(3.5bytes Blank)	Inverter No.	Command	Communication No. (high)	Communication No. (low)	Number of Data Groups (high)	Number of Data Groups (low)	CRC (low)	CRC (high)	(3.5bytes Blank)
		03			00	01			

- 1) Inverter No.. (1 byte) : Specify an inverter number between 0 and 247 (00H to F7H).  
Command processing will be executed only broadcast communication "0" and with those inverters that match set inverter numbers. Data will not be returned if "0" (broadcast communication) and inverter numbers do not match.
- 2) Command (1 byte) : Set the read command (03H fixed).
- 3) Communication No.. (2 bytes) : Set in the order of high to low numbers.
- 4) Number of data groups (2 bytes) : Set the number of data words 0001 (fixed) in the order of high to low numbers.
- 5) CRC (2 bytes) : Set generation results of CRC in the order of low to high numbers.. For the method to generate CRC, see "5.2 CRC Generation." Note that the setting sequence is reversal to that of others.

- VF-S11 Computer (Normal return) \*The text size is 7 bytes fixed.

(3.5bytes Blank)	Inverter No.	Command	Number of Data	Read data (high)	Read data (low)	CRC (low)	CRC (high)
		03	02				

- 1) Command (1 byte) : Read command (03H fixed) will be returned.
- 2) Number of data : A number of data bytes (02H fixed) will be returned. The number of data groups for transmission to the inverters is 2 bytes and 01H fixed. Note that the number of data returned by the inverters is 1 byte and 02H fixed.
- 3) Read data (2 bytes) : Returned in the order of read data (high) and (low).

- VF-S11 Computer (Abnormal return) \*The text size is 5 bytes fixed.

(3.5bytes Blank)	Inverter No.	Command	Error Code	CRC (low)	CRC (high)
		83			

- 1) Command (1 byte) : 83H fixed (Read command error) (Command + 80H)
- 2) Error code (1 byte) : See "4.3 Transmission errors."

#### ■ Example: Reading output frequency (During 60Hz operation)

(Computer → inverter) 01 03 FD 00 00 01 B5 A6  
(Inverter → computer) 01 03 02 17 70 B6 50

#### ■ Example: Data specification error

(Computer → inverter) 01 03 FD 00 00 02 F5 A7  
(Inverter → computer) 01 83 03 01 31

## 5.1.2. Write command (06)

- Computer VF-S11 \*The text size is 8 bytes fixed.

(3.5bytes Blank)	Inverter No.	Command	Communication No. (high)	Communication No. (low)	Write Data (high)	Write Data (low)	CRC (low)	CRC (high)	(3.5bytes Blank)
		06							

- Inverter No. (1 byte) : Specify an inverter number between 0 and 247 (00H to F7H).  
Command processing will be executed only broadcast communication "0" and with those inverters that match set inverter numbers. Data will not be returned if "0" (broadcast communication) and inverter numbers do not match.
- Command (1 byte) : Set the write command (06H fixed).
- Communication No. (2 bytes) : Set in the order of high to low numbers.
- Write data (2 bytes) : Set in the order of high to low write data.
- CRC (2 bytes) : Set generation results of CRC in the order of low to high numbers. For the method to generate CRC, see "5.2 CRC Generation." Note that the setting sequence is reversal to that of others.

- VF-S11 → Computer (Normal return) \*The text size is 8 bytes fixed.

(3.5bytes Blank)	Inverter No.	Command	Communication No. (high)	Communication No. (low)	Write Data (high)	Write Data (low)	CRC (low)	CRC (high)	(3.5bytes Blank)
		06							

- Command (1 byte) : Write command (06H fixed) will be returned.
- Write data (2 bytes) : Returned in the order of write data (high) and (low).

- VF-S11 → Computer (Abnormal return) \*The text size is 5 bytes fixed.

(3.5bytes Blank)	Inverter No.	Command	Error Code	CRC (low)	CRC (high)
		86			

- Command (1 byte) : 86H fixed (Read command error) (Command + 80H)
- Error code (1 byte) : See "4.3 Transmission errors."

- Example: Writing in frequency command value (FA01) (60Hz)

(Computer → inverter)                   01 06 FA 01 17 70 E6 C6  
(Inverter → computer)                 01 06 FA 01 17 70 E6 C6

- Example: Communication number error

(Computer → inverter)                   01 06 FF FF 00 00 89 EE  
(Inverter → computer)                 01 86 02 C3 A1

### Note

- ▼ The EEPROM life is 10,000 operations.  
Do not write in the same parameter that has an EEPROM more than 10,000 times.  
The communication commands (FA00, FA20, FA26), communication frequency command (FA01), terminal output data (FA50) and analog output data (FA50) are stored in the RAMs only and no restrictions are placed on them.

## 5.2. CRC Generation

“CRC” is a system to check errors in communication frames during data transmission. CRC is composed of two bytes and has hexadecimal-bit binary values. CRC values are generated by the transmission side that adds CRC to messages. The receiving side regenerates CRC of received messages and compares generation results of CRC regeneration with CRC values actually received. If values do not match, data will be aborted.

### ■ Flow

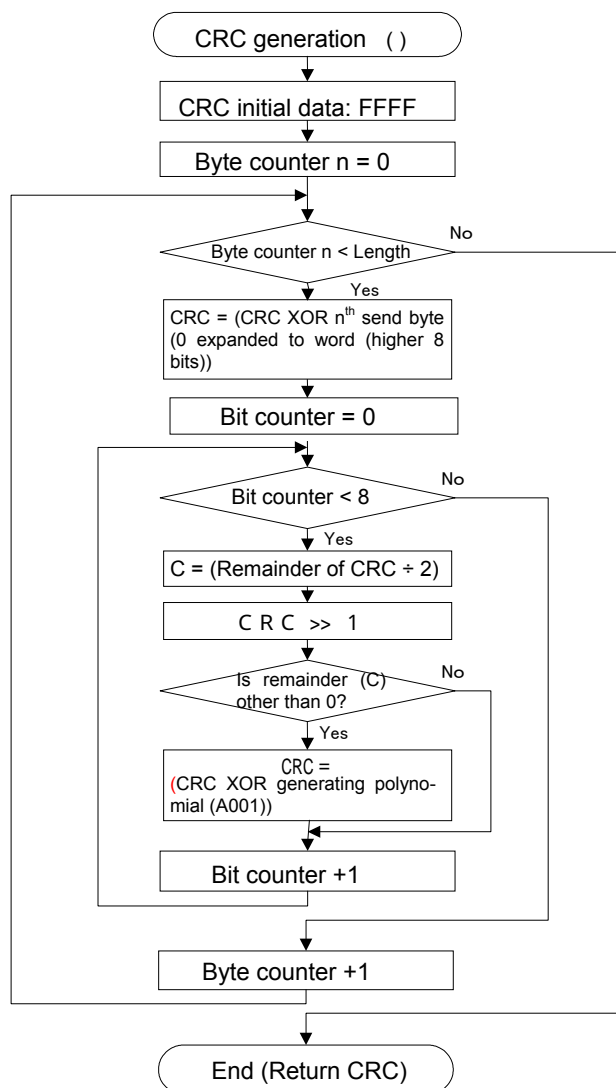

#### A procedure for generating a CRC is:

1. Load a 16-bit register with FFFF hex (all 1's). Call this the CRC register.
2. Exclusive OR the first 8-bit byte of the message with the low-order byte of the 16-bit CRC register, putting the result in the CRC register.
3. Shift the CRC register one bit to the right (toward the LSB), zero-filling the MSB. Extract and examine the LSB.
4. (If the LSB was 0): Repeat Step 3 (another shift).  
(If the LSB was 1): Exclusive OR the CRC register with the polynomial value A001 hex (1010 0000 0000 0001).
5. Repeat Steps 3 and 4 until 8 shifts have been performed. When this is done, a complete 8-bit byte will have been processed.
6. Repeat Steps 2 through 5 for the next 8-bit byte of the message. Continue doing this until all bytes have been processed.
7. The final contents of the CRC register is the CRC value.
8. When the CRC is placed into the message, its upper and lower bytes must be swapped as described below.

## 5.3. Error codes

In case of the following errors, the return commands from the inverters are added 80h to the commands received by the inverters. The following error codes are used.

Error Code	Description
01	Command error (Returned when a command other than 03 or 06 is received)
02	Communication number error (A communication number is not found when Command 03 or 06 is received)
03	Data range error (Data range error when Command 03 or 06 is received)
04	Unable to execute (Command 06 is being received and data cannot be written) (1) Writing in write-disable-during-operation parameter (2) Writing in parameter that is executing TYP

## 6. Inter-drive communication

Inter-drive communication function enables manipulation of multiple inverters without using the host computer such as the PLC and the PC. This function is utilized for "speed proportional control". The command is instructed by the operation from the master inverter's panel or analog input, etc.

With the Inter-drive communication function, the master inverter continues to transmit the data selected by the parameters to all the slave inverters on the same network. The master inverter uses the S command for outputting instructions to the slave inverters, and the slave inverters do not return the data. (See chapter 4.2 "Command".) Network construction for a simple synchronized operation and speed-proportional operation can be created by this function.

The inverters on the slave side are always ready to receive messages during inter-drive communications and perform slave operation in response to requests made by the inverters on the master side or computer requests during inter-drive communications. The inverters on the master side are always ready to send messages during inter-drive communications and do not receive data.

To use the inter-drive communication function, select "TOSHIBA Inverter Protocol" ( $F 8 2 9 = 0$ ) in the communication protocol selection parameters. "TOSHIBA Inverter Protocol" ( $F 8 2 9 = 0$ ) is set for communication protocol selection in Shipment setting. (See "3. Communication protocol.")

<Conceptual illustration>

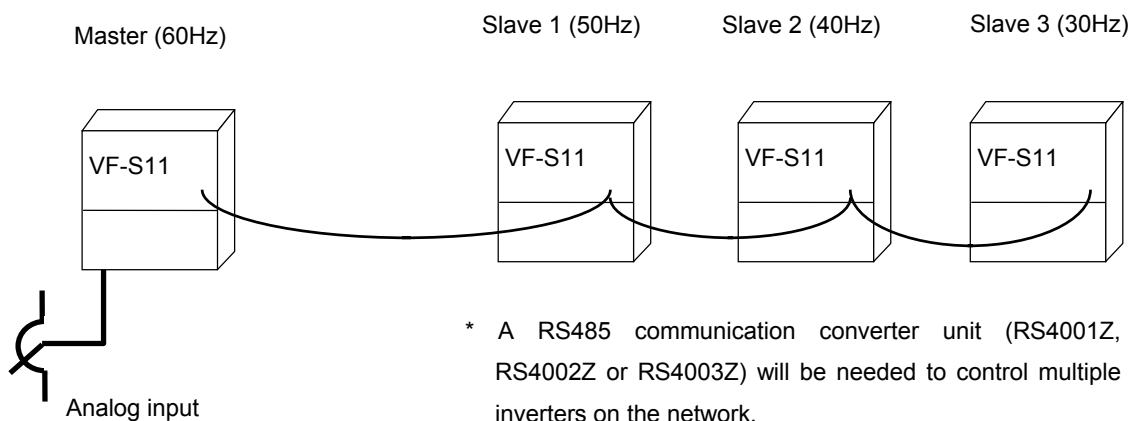

<Notes>

Speed command can be transmitted but the run / stop signal is not issued. Slave station should have an individual stop signal or the function to stop the action by the frequency reference. (Setting is necessary for  $F 2 4 1$ : Operation starting frequency,  $F 2 4 2$ : Operation starting frequency hysteresis .)

For continuing the operation by the last received command value in the case of a communication breakdown, provide a communication time-out interval ( $F 8 0 3$ ) to trip the slave inverters. The master inverter does not trip even though the communication breakdown happens. To trip the master inverter, provide an interlock mechanism by installing an FL fault relay point or the like from the slave side.

## ■ Setting of parameter

---

- Selection of communication protocol (F829) ... Shipment setting: 0 (TOSHIBA Inverter Protocol)  
Protocol setting with all inverters (both master and slave inverters) engaged in inter-drive communications

0: Set the TOSHIBA Inverter Protocol.

\* Inter-drive communications are disabled when the MODBUS-RTU protocol is selected.

\* This parameter is validated after resetting the inverter or rebooting the power supply.

- Setting of master and slave inverters for communication between inverters (setting of master and slave) (F806) ... Shipment setting = 0

Assign one master inverter in the network. Other inverters should be the slave inverters.

\* Specify only one inverter as the master. In case two or more inverters are designated for the master inverter in the same network, data will collide.

- Setting to the master inverter

Set data desired for sending from the master side to the slave side.

3: Master inverter (transmission of frequency commands) 4: Master inverter (transmission of output frequency signals)

- Setting to the slave inverters

Set the desired action on the slave side that will be needed when the master trips.

0: Sets the frequency command value to 0Hz. (Output frequency is limited by low-limit frequency)

1: Normal operation is continued

(If an output frequency is set on the master side, the output frequency of the master side becomes 0Hz due to tripping and the frequency of commands to the slave side becomes 0Hz.)

2: Makes an emergency stop ("E" trip).

(The method to stop follows the setting in "Emergency stop selection (F603)")

\* This parameter is validated after resetting the inverter or rebooting the power supply.

- Communication waiting time (F805) ... Shipment setting = 0.00

- Setting to the master inverter

Set up more than 0.03 seconds as a transmitting interval on the master side to wait for the processing time on the slave side (F805 = 0.03).

- Speed setting mode selection (F804) ... Shipment setting = 0: Built-in potentiometer

Designate a target of speed command input for the inverter to the parameter F804.

- Setting to the master inverter

Designate a number except for "4: serial communication" (F804 ≠ 4).

- Setting to the slave inverters

Designate "4: serial communication" (F804 = 4).

## ■ Relating communication parameters

Following parameters should be set or changed if necessary.

- Communication baud rate (F800)... Shipment setting = 3: 9600bps

Baud rate of all inverters in the network (master and slave) should be same network.

- Parity (F801) ... Shipment setting = 1: Even parity

Parity of all inverters in the network (master and slave) should be same network.

- Communication error trip time(F803) ... Shipment setting = 0

Operation is continued by the last received command value in the case of a communication breakdown. To stop the operation of inverter, provide a communication time-out interval (ex. F803= 1) to the slave inverters. The master inverter does not trip even though the communication breakdown happens. To trip the master inverter, provide an interlock mechanism by installing a FL fault relay point or the like from the slave side.

- Frequency point selection (F811-F814)

Adjusted to the system.

See chapter "6.1 Speed proportional control" for details.

## ■ Setting example of parameters

### Parameters relating to the master side (example)

F805:4 Master (transmission of output frequency (%) (100% at FH))  
 F829:0 Selection of communication protocol (Toshiba inverter protocol)  
 F800:4 Communication baud rate (ex. 19200bps)  
 F801:1 Parity (even parity)  
 CN0d:1 Example: Panel  
 FN0d:0 Example: Built-in potentiometer  
 F805:0.03 Communication waiting time (ex. 30msec)

### Parameters relating to the slave side (example)

F806: 0 Slave (0Hz command issued in case the master inverter fails)  
 F829: 0 Selection of communication protocol (Toshiba inverter protocol)  
 F803: 1 Communication time-out (ex. 1 second)  
 F800: 4 Communication baud rate (same to the master side)  
 F801: 1 Parity (same to the master side)  
 CN0d: 0 Terminal block (ex. Driven by F, ST)  
 (F24 1: Run and stop of operation is controlled with the frequency reference value by setting the "run frequency".)

< For speed control >

FN0d: 4 Serial communication  
 F811: ? Adjusted to the system Point 1 setting (%)  
 F812: ? Ditto Point 2 frequency (Hz)  
 F813: ? Ditto Point 2 setting (%)  
 F814: ? Ditto Point 2 frequency (Hz)

## 6.1. Speed proportional control

Various inclinations can be set by frequency point setting.

The frequency command value on the slave side during inter-drive communication can be expressed by the following formulas.

If inter-drive communication is not selected ( $F805=0$ ), point conversion is not performed.

Point conversion is performed only when the command "S" is received.

(Ex.)

< unit > Frequency unit: 1=0.01(Hz), point setting unit: 1=0.01%

	Maximum frequency (FH)	Point 1 setting (F811)	Point 1 frequency (F812)	Point 2 setting (F813)	Point 2 frequency (F814)	Frequency (Fc)
Master (Fc)	100.00Hz (10000)	-	-	-	-	50.00Hz (5000)
Slave 1	100.00Hz (10000)	0.00% (0)	0.00Hz (0)	100.00% (10000)	90.00Hz (9000)	45.00Hz (4500)
Slave 2	100.00Hz (10000)	0.00% (0)	0.00Hz (0)	100.00% (10000)	80.00Hz (8000)	40.00Hz (4000)

Sending data from the master:

$$\text{Master send fc(\%)} = \frac{\text{Master side fc} \times 10000}{\text{Master side FH}} = \frac{5000 \times 10000}{10000} = 5000 = 50\%$$

Slave frequency Command(Hz)=

$$\frac{\text{Point 2 frequency(F813)} - \text{Point 1 frequency(F812)}}{\text{Point 2(F814)} - \text{point 1(F811)}} \times (\text{Master command (\%)} - \text{Point 1(F811)}) + \text{Point 1 frequency(F812)}$$

By the point conversion process,

$$\text{Slave 1: fc(Hz)} = \frac{9000 - 0}{10000 - 0} \times (5000 - 0) + 0 = 4500 = 45\text{Hz}$$

$$\text{Slave 2: fc(Hz)} = \frac{8000 - 0}{10000 - 0} \times (5000 - 0) + 0 = 4000 = 40\text{Hz}$$

【 Diagram of speed proportional control 】

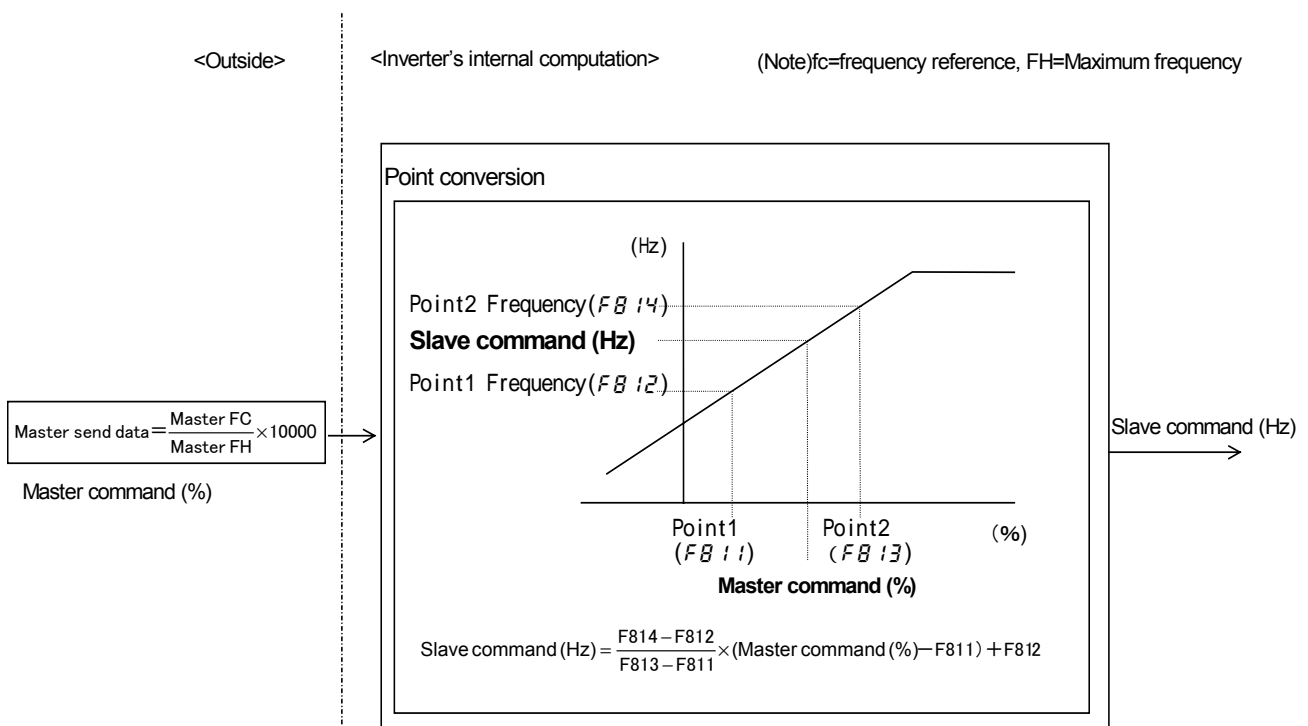



## 6.2. Transmission format for inter-drive communication

Data type is handled in hexadecimal notation and the transmission characters are treated with the binary (HEX) code.

The transmission format is basically the same to the case of binary mode. S command is used and the slave inverters do not return the data.

### ■ Master inverter (VF-S11) to slave inverter (VF-S11) (Binary mode)

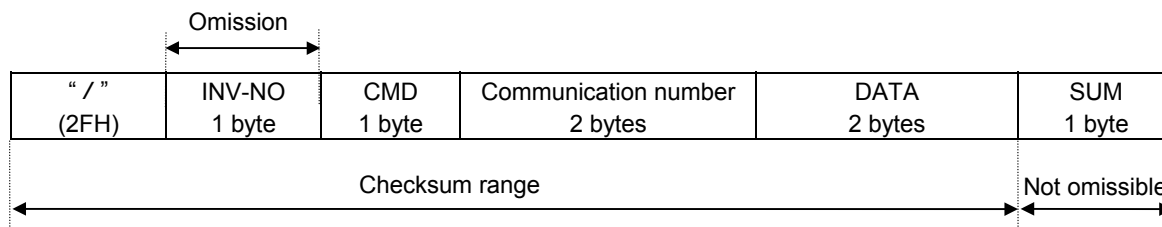

- 1) INV-NO (1 byte) : Inverter number  
This is always excluded at the master inverter side at time of inter-drive communication, and can be added when the user utilize this data for the purpose of proportional operation.  
(When this code is added, only the inverter concerned will accept the data.)
- 2) CMD (1 byte) : Command  
53H(“S”) or 73(“s”) command ... command for inter-drive communication  
When the master inverter is not tripping, this will be 53H(“S”).  
When the master inverter is tripping, this will be 73H(“s”).
- 3) Communication number (2 bytes) :  
Communication number of frequency command (FA01).
- 4) DATA (2 bytes) : Data of frequency command value.  
(0000H to FFFFH (no range check))

As for the S command, see section 4.2 “Commands”, and see chapter “6 Inter-drive communication function” for the communication of inverters.

## 7. Communications parameters

The settings of communication-related parameters can be changed from the operation panel and the external controller (computer). Note that there are two types of parameters: parameters whose settings take effect immediately after the setting and parameters whose settings do not take effect until the inverter is turned back on or reset.

Communication Number.	Title	Function	Adjustment range	Unit	Default setting	Valid	Reference
0800	<i>F800</i>	Communication baud rate	0: 1200bps 1: 2400bps 2: 4800bps 3: 9600bps 4: 19200bps	-	3	After reset.	Section 7.1
0801	<i>F801</i>	Parity	0: NON (No parity) 1: EVEN (Even parity) 2: ODD (Odd parity)	-	1	After reset.	Section 7.1
0802	<i>F802</i>	Inverter number	0-255	1	0	Real time	Section 7.2
0803	<i>F803</i>	Communication error trip time	0: (disabled) 1-100	1s	0	Real time	Section 7.3
0805	<i>F805</i>	Communication waiting time	0.00-2.00s	0.01s	0.00	Real time	Section 7.4
0806	<i>F806</i>	Setting of master and slave inverters for communication between inverters (setting of master and slave)	0: Slave inverter (0 Hz command issued in case the master inverter fails) 1: Slave inverter (Operation continued in case the master inverter fails) 2: Slave inverter (Emergency stop tripping in case the master inverter fails) 3: Master inverter (transmission of frequency commands) 4: Master inverter (transmission of output frequency signals)	-	0	After reset.	Chapter 6
0811	<i>F811</i>	Point 1 setting	0-100	1%	0	Real time	Section 6.1
0812	<i>F812</i>	Point 1 frequency	0.0-500.0Hz	0.01Hz	0.0	Real time	
0813	<i>F813</i>	Point 2 setting	0-100	1%	100	Real time	
0814	<i>F814</i>	Point 2 frequency	0.0-500.0Hz	0.01Hz	60.0	Real time	
0829	<i>F829</i>	Selection of communication protocol	0: Toshiba inverter protocol 1: Modbus-RTU protocol	-	0	After reset.	Chapter 3
0870	<i>F870</i>	Block write data 1	0: No selection 1: Command information 1 2: Command information 2 3: Frequency command 4: Output data on the terminal board 5: Analog output for communications	-	0	After reset.	Section 4.1.3
0871	<i>F871</i>	Block write data 2					
0875	<i>F875</i>	Block read data 1	0: No selection 1: Status information				
0876	<i>F876</i>	Block read data 2	2: Output frequency				
0877	<i>F877</i>	Block read data 3	3: Output current 4: Output voltage				
0878	<i>F878</i>	Block read data 4	5: Alarm information 6: PID feedback value				
0879	<i>F879</i>	Block read data 5	7: Input terminal board monitor 8: Output terminal board monitor 9: VIA terminal board monitor 10: VIB terminal board monitor				
0880	<i>F880</i>	Free notes	0-65535	1	0	Real time	Section 7.5

---

## 7.1. Communication baud rate(F800) , Parity bit(F801)

---

- Communication baud rate and parity bit should be uniform inside the same network.
- This parameter is validated by resetting the power supply.

---

## 7.2. Inverter number(F802)

---

This parameter sets individual numbers with the inverters.

Inverter numbers should not be duplicate inside the same network.

Receiving data will be canceled if inverter numbers specified in individual communications and set by a parameter do not match.

This parameter is validated from the communication after change

Data range: 0 to 255 (Initial value: 0)

Parameters can be selected between 0 and 255. Note that the communication protocols limit inverter numbers as follows:

- TOSHIBA Inverter Protocol ASCII mode: 0 to 99
- TOSHIBA Inverter Protocol Binary mode: 0 to 63
- MODBUS Protocol: 0 to 247

## 7.3. Timer function(F803)

This function detects any normal data that is not detected even once within an arbitrarily predetermined time.

The timer function is used to detect breaks in cables during communications and to trip an inverter (Err 5) if the inverter has received no data within the time specified using this function. If the inverter number does not match or if a format error occurs, preventing the inverter from returning data to the computer, this function will assume that the inverter has not received any data.

### ■ How to set the timer

The communication error trip time parameter (F803) is set to 0 (timer off) by default.

\* Timer adjustment range

About 1 sec. (01H) to about 100 sec. (64H) / Timer off (0H)

### ■ How to start the timer

If the timer is set from the operation panel, it will start automatically the instant when communication is established for the first time after the setting.

If the timer is set from the computer, it will start automatically the instant when communication is established after the setting.

If the timer setting is stored in the EEPROM, the timer will start when communication is established for the first time after the power has been turned on.

Note that, if the inverter number does not match or if a format error occurs, preventing the inverter from returning data, the timer function will assume that no communication has taken place and will not start.

### ■ How to disable the timer

To disable the timer, set its parameter to 0.

Ex.: To disable the timer function from the computer (To store the timer setting in the EEPROM)

Computer → Inverter

Inverter → Computer

(W08030)CR

(W08030000)CR

... Sets the timer parameter to 0 to disable it.

### ■ Timer

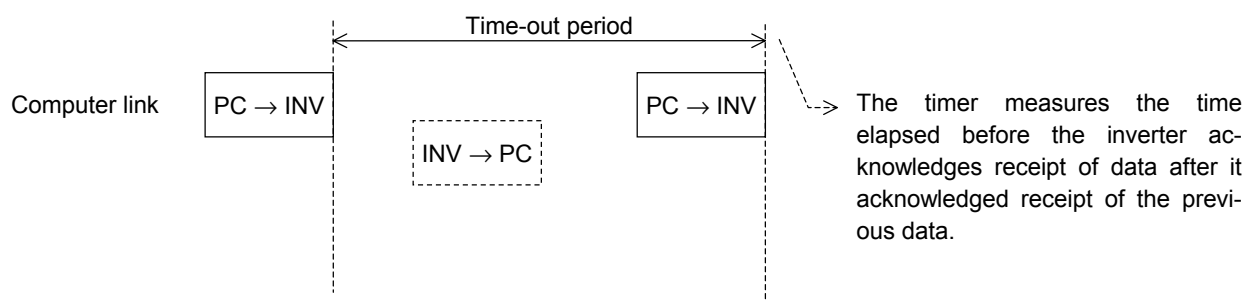

## 7.4. Setting function of communication waiting time (F805)

Use this function for the following case:

When the data response from the inverter is too quick after the PC had sent the data to the inverter, PC process cannot get ready to receive the data, or when the RS485/RS232C converter is used, changeover of sending and receiving data takes much time in the converter process.

The case of " Inter-drive communication ", set up more than 0.03 seconds as a transmitting interval on the master side to wait for the processing time on the slave side (F805 = 0.03).

\* This function, however, does not operate in case the MODBUS-RTU protocol is selected in communication protocol selection. (F829 = 1)

Functional specification:

A time for sending data is prolonged longer than the preset time, until the inverter returns the data to the PC, after it finishes receiving the data (in case of an inter-drive communication, until the inverter returns the next data to the PC, after it has sent the data.) In case the inverter's processing capacity requires longer setting time, the value more than this time will be the set value. (The parameter makes the inverter wait for more than the set time.)

Setting range: 0.01 to 2.00 seconds (10ms to 2000ms)

If the set value is 0, this function becomes invalid and the interval time for sending data is set to the maximum capacity of the inverter. To obtain a quick response for sending data, set value 0.

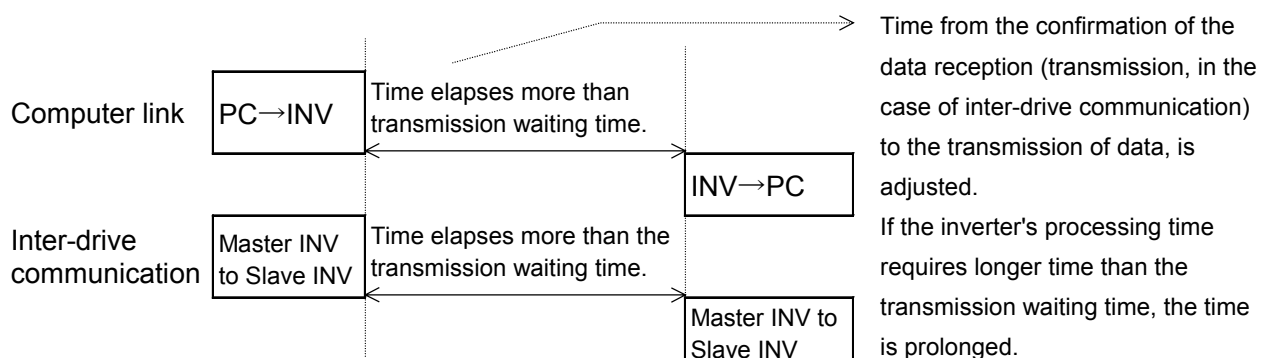

## 7.5. Free notes (F880)

This parameter allows you to write any data, e.g., the serial number of each inverter or parameter information, which does not affect the operation of the inverter.

## 8. Commands and monitoring from the computer

Across the network, instructions (commands and frequency) can be sent to each inverter and the operating status of each inverter can be monitored.

### 8.1. Communication commands (commands from the computer)

#### ■ Communication command (Communication number: FA00)

Commands can be executed on inverter frequencies and operation stop through communications. The VF-S11 series can enable command and frequency settings through communications irrespective of settings of the command mode ( $\overline{CND}$ ) and frequency mode ( $\overline{FND}$ ). However, if "48: Forced change from communication to local," "52: Forced operation," or "53: Fire speed" is set by input terminal function selection ( $F11Q$  to  $F11B$ ), a change to a command other than communication and to a frequency command is feasible through a contact on the terminal board.

Once the communication command (FA00) is set to enable communication command priority and frequency priority, both priorities will be enabled unless OFF is set, power is turned off or is reset, or standard shipment setting ( $\overline{LSP}$ ) is selected. Emergency stop, RY terminal output hold and OUT terminal output hold are always enabled even though communication command priority is not set.

Table 1 Data construction of communication commands (communication number: FA00)

bit	Specifications	0	1	S7	S9/nC1/S11	Remarks
0	Preset speed operation frequencies 1	Preset speed operation is disabled or preset speed operation frequencies (1-15) are set by specifying bits for preset speed operation frequencies 1-4. (0000: Preset speed operation OFF, 001-1111: Setting of preset speed operation frequencies (1-15))		✓	✓	Preset speed operation can be disabled or a preset speed operation frequencies (1-15) can be specified by combining 4 bits variously.
1	Preset speed operation frequencies 2					
2	Preset speed operation frequencies 3					
3	Preset speed operation frequencies 4					
4	Motor selection (1 or 2) (THR 2 selection)	Motor 1 (THR 1)	Motor2 (THR2)	-	✓	THR1 : PT=set value, vL, vb, tHr THR2 : PT=0, F170, F172, F173
5	PI control	Normal operation	PI OFF	-	✓	
6	Acceleration/deceleration pattern selection (1 or 2) (AD2 selection)	Acceleration/deceleration pattern 1 (AD1)	Acceleration/deceleration pattern 2 (AD2)	✓	✓	AD1 : ACC, DEC, AD2 : F500, F501
7	DC braking	OFF	Forced DC braking	✓	✓	
8	Jog run	OFF	Jog run	✓	✓	
9	Forward/reverse run selection	Forward run	Reverse run	✓	✓	
10	Run/stop	Stop	Run	✓	✓	
11	Coast stop command	Standby	Coast stop	✓	✓	
12	Emergency stop	OFF	Emergency stop	✓	✓	"E" trip
13	Fault reset	OFF	Reset	✓	✓	No data is returned from the inverter.
14	Frequency priority selection	OFF	Enabled	✓	✓	Enabled regardless of the setting of $\overline{FND}$
15	Command priority selection	OFF	Enabled	✓	✓	Enabled regardless of the setting of $\overline{CND}$

Note: For the reset command, no data will be returned.

Ex.: Forward run: (PFA008400) CR

1 is specified for bit 15 (communication command: enabled) and bit 10 (operation command).

FA00: 

BIT15	1	0	0	0	1	0	0	0	0	0	0	0	0	0	BIT0
	8			4				0				0			

Ex.: Reverse run: (PFA008600) CR, (PFA00C600) CR

8600H : To disable frequency instructions from the computer

C600H : To enable also frequency instructions from the computer

## ■ Communication command2 (Communication Number : FA20)

This command is enabled only when the communication command is enabled. Set Bit 15 of Communication Command 1 (communication Number: FA00) to "1" (enable). When enabling the communication command by Communication Command 1, commands by communications can be given the priority irrespective of the setting of the command mode selection parameter ( $CMD$ ). However, if "48: Forced change from communication to local," "52: Forced operation," or "53: Fire speed" is set by input terminal function selection ( $F10$  to  $F18$ ), the enabled command and frequency will be given the priority.

Once enabled, this setting will be enabled till disable is set (0 setting), power is turned off or is reset, or standard shipment setting ( $SP$ ) is selected.

Table 2 Data construction of serial communication command 2 (FA20)

Bit	Function	0	1	Remarks
0	(Reserved)	-	-	
1	electric power quantity reset	OFF	Reset	electric power quantity (FE76, FE77) reset
2	(Reserved)	-	-	
3	(Reserved)	-	-	
4	(Reserved)	-	-	
5	(Reserved)	-	-	
6	(Reserved)	-	-	
7	(Reserved)	-	-	
8	Acceleration/deceleration pattern selection 1	00: Acceleration/deceleration 1 01: Acceleration/deceleration 2 10: Acceleration/deceleration 3, 11: Disabled (Acceleration/deceleration 3)		Select Acceleration/ deceleration 1 - 3 by combination of two bits AD1: ACC, DEC AD2: F500, F501 AD3: F510, F511
9	Acceleration/deceleration pattern selection 2			
10	(Reserved)	-	-	
11	(Reserved)	-	-	
12	Over-current stall level change	OC stall 1	OC stall 2	OC1: F601 OC2: F185
13	(Reserved)	-	-	
14	(Reserved)	-	-	
15	(Reserved)	-	-	

Note: The acceleration/deceleration change command ORs with Bit 6 of Communication number FA00. Set Bit 6 of FA00 to "0" and use FA20 when changing acceleration/deceleration in three types. Acceleration/deceleration 3 will be set when both Bit 8 of Communication number FA20 (or Bit 6 of Communication number FA00) and Bit 9 of Communication number FA20 are set.

## ■ Communication command3 (Communication number: FA26)

The RY Terminal Output Hold Command and OUT Terminal Output Hold Command are always enabled even though communication command priority is not set.

Table 3 Data construction of Serial Communication Command 3 (FA26)

Bit	Function	0	1	Remarks
0	RY terminal output hold	OFF	Once it is turned on, a RY terminal holds that condition.	Always enabled even if communication command is not enabled
1	OUT terminal output hold	OFF	Once it is turned on, an OUT terminal holds that condition.	Always enabled even if communication command is not enabled
2	(Reserved)	-	-	
3	(Reserved)	-	-	
4	(Reserved)	-	-	
5	(Reserved)	-	-	
6	(Reserved)	-	-	
7	(Reserved)	-	-	
8	(Reserved)	-	-	
9	(Reserved)	-	-	
10	(Reserved)	-	-	
11	(Reserved)	-	-	
12	(Reserved)	-	-	
13	(Reserved)	-	-	
14	(Reserved)	-	-	
15	(Reserved)	-	-	

## ■ Frequency setting from the computer (communication number: FA01)

Setting range: 0 to Maximum frequency ( $FH$ )

This frequency command is enabled only when the frequency command by communication is enabled by setting "serial communication ("3" for Communication Number FA04) by the speed command selection parameter ( $FND$ ) or setting command priority (Bit 14 of Communication Number FA00 to "1" (enable)) by the communication command. In this case, frequency commands by communication will be enabled independent of  $FND$  setting. However, enabled commands and frequencies are given the priority if "48: Forced change from communication to local," "52: Forced operation," or "53: Fire speed" is set by input terminal function selection ( $F1I$  to  $F1B$ ).

Once enabled, this frequency setting will be enabled till disable is set (0 setting), power is turned off or is reset, or standard shipment setting ( $ESP$ ) is selected.

Set a frequency by communication hexadecimal in Communication Number FA01. (1 = 0.01Hz (unit))

Example: Operation frequency 80Hz command (PFA011F40) CR  
 $80\text{Hz} = 80 \div 0.01 = 8000 = 1F40\text{H}$



## 8.2. Monitoring from the computer

This section explains how to monitor the operating status of the inverter from the computer.

### ■ Monitoring of the operation frequency from the computer (FE00, FD00)

Operation frequency (frequency immediately before the occurrence of a trip):

Communication Number FE00 (Minimum unit: 0.01 Hz)

Operation frequency (current frequency): Communication Number FD00 (Minimum unit: 0.01 Hz)

Ex.: Monitoring of operation frequency (during 50 Hz operation) ... (1388H = 5000d, 5000 x 0.1 = 50 Hz)

Computer → Inverter

(RFD00) <sub>CR</sub>

Inverter → Computer

(RFD001388) <sub>CR</sub>

### ■ Inverter operating status (FE01, FD01)

Operating status (status immediately before the occurrence of a trip):

Communication Number FE01

Operating status (current status):

Communication Number FD01

Table 2 Data construction of inverter operating status (FE00/FD00) (\*: FD01 supports the VF-S11 and later models.)

Bit	Specifications	0	1	S7	S9	S11/nC1	Remarks
0	Failure FL	No output	Output in progress	-	-	✓	
1	Failure	Not tripped	Tripped	-	-	✓	Trip statuses include $r$ , $t$ , $r$ , $g$ and trip retention status.
2	Alarm	No alarm	Alarm issued	-	-	✓	
3	Reserved	-	-	-	-	-	
4	Motor section (1 or 2) (THR 2 selection)	Motor 1 (THR 1)	Motor 2 (THR 2)	-	✓	✓	THR1: PT=set value, vL, vb, Thr THR2:PT=0, F170, F172, F173
5	PI control OFF	PI control permitted	PI control prohibited	-	✓	✓	
6	Acceleration/deceleration pattern selection (1 or 2)	Acceleration/deceleration pattern 1 (AD 1)	Acceleration/deceleration pattern 2 (AD 2)	✓	✓	✓	AD1 :ACC, DEC, AD2 :F500, F501
7	DC braking	OFF	Forced DC braking	✓	✓	✓	
8	Jog run	OFF	Jog run	✓	✓	✓	
9	Forward/reverse run	Forward run	Reverse run	✓	✓	✓	
10	Run/stop	Stop	Run	✓	✓	✓	
11	Coast stop (ST=OFF)	ST=ON	ST=OFF	-	✓	✓	
12	Emergency stop	Not emergency stop status	Emergency stop status	-	✓	✓	
13	Standby ST=ON	Start-up process	Standby	-	-	✓	Standby: Initialization completed, not failure stop status, not alarm stop status (MOFF, LL forced stop or forced stop due to a momentary power failure), ST=ON, and RUN=ON
14	Standby	Start-up process	Standby	-	-	✓	Standby: Initialization completed, not failure stop status, and not alarm stop status (MOFF, LL forced stop or forced stop due to a momentary power failure)
15	Reserved	-	-	-	-	-	

## ■ Inverter operating status3 (FE42, FD42)

Operating status 3(status immediately before the occurrence of a trip):

Communication Number FE42

Operating status 3(current status):

Communication Number FD42

Bit	Function	0	1	Remarks
0	(Reserved)	-	-	
1	Electric Power Counting (FE76,FE77) status	Counting	Resetting	
2	(Reserved)	-	-	
3	(Reserved)	-	-	
4	(Reserved)	-	-	
5	(Reserved)	-	-	
6	(Reserved)	-	-	
7	(Reserved)	-	-	
8	Acceleration/deceleration pattern selection1	00:Acceleration/deceleration 1 01:Acceleration/deceleration 2		Acceleration/ decelera- tion 1 - 3 can be speci- fied by combination of two bits
9	Acceleration/deceleration pattern selection2	10:Acceleration/deceleration 3		
10	(Reserved)	-	-	
11	(Reserved)	-	-	
12	Over-current stall level change	OC stall 1	OC stall 2	OC1:F601 OC2:F185
13	(Reserved)	-	-	
14	(Reserved)	-	-	
15	(Reserved)	-	-	

## ■ Inverter operating status4 (FE49, FD49)

Operating status 4(status immediately before the occurrence of a trip):

Communication Number FE49

Operating status 4(current status):

Communication Number FD49

Bit	Function	0	1	Remarks
0	RY terminal output hold	OFF	Holding	
1	OUT terminal output hold	OFF	Holding	
2 to 15	(Reserved)	-	-	

## ■ Inverter operating command mode status (FE45)

---

The monitor of the command mode that the present condition is enabled

Data	Enabled command
0	Terminal board
1	Operation panel
2	Serial communication

## ■ Inverter operating frequency mode status (FE46)

---

The monitor of the frequency command mode that the present condition is enabled

Note that Preset speed operation frequencies is given the priority independent of the frequency mode, in which case this monitor will be disabled, in case Preset speed operation frequencies is selected.

Data	Enabled frequency
0	Potentiometer at Operation panel
1	VIA
2	VIB
3	Operation panel
4	Serial communications
5	TB up down frequency
6	VIA + VIB

## ■ Alarm information monitor (FC91)

Bit	Specifications	0	1	Remarks (Code displayed on the panel)
0	Over-current alarm	Normal	Alarming	$\zeta$ flickering
1	Inverter overload alarm	Normal	Alarming	$\iota$ flickering
2	Motor overload alarm	Normal	Alarming	$\lambda$ flickering
3	Overheat alarm	Normal	Alarming	$\mathcal{H}$ flickering
4	Overvoltage alarm	Normal	Alarming	$\mathcal{P}$ flickering
5	Main circuit undervoltage alarm	Normal	Alarming	-
6	(Reserved)	-	-	-
7	Low current alarm	Normal	Alarming	-
8	Over-torque alarm	Normal	Alarming	-
9	Braking resistor overload alarm	Normal	Alarming	-
10	Cumulative operation hours alarm	Normal	Alarming	-
11	(Reserved)	-	-	-
12	(Reserved)	-	-	-
13	Main-circuit voltage error alarm	Normal	Alarming	" $\eta$ FFF" flickering
14	At the time of the instant black-out, Forced deceleration/stop	-	Decelerating, stopping	Related: F256 setting
15	An automatic stop during the lower limit frequency continuance	-	Decelerating, stopping	Related: F302 setting

## ■ Cumulative operation time alarm monitor (FE79)

Bit	Specifications	0	1	Remarks
0	Fan life alarm	Normal	Alarm issued	-
1	Circuit board life alarm	Normal	Alarm issued	-
2	Main-circuit capacitor life alarm	Normal	Alarm issued	-
3	User set alarm	Normal	Alarm issued	-
4-15	(Reserved)	-	-	-

■ Trip code monitor (current status: FC90: historic records: FE10 to FE13)

Code	Data (hexadecimal number)	Data (decimal number)	Description
<i>nErr</i>	0	0	No error
<i>OC1</i>	1	1	Over-current during acceleration
<i>OC2</i>	2	2	Over-current during deceleration
<i>OC3</i>	3	3	Over-current during constant speed operation
<i>OCL</i>	4	4	Over-current in load at startup
<i>OCA</i>	5	5	Short circuit in arm
<i>EPH1</i>	8	8	Input phase failure
<i>EPHO</i>	9	9	Output phase failure
<i>OP1</i>	A	10	Overvoltage during acceleration
<i>OP2</i>	B	11	Overvoltage during deceleration
<i>OP3</i>	C	12	Overvoltage during constant speed operation
<i>OL1</i>	D	13	Over-LOAD in inverter
<i>OL2</i>	E	14	Over-LOAD in motor
<i>OH</i>	10	16	Overheat trip
<i>E</i>	11	17	Emergency stop
<i>EEP1</i>	12	18	EEPROM fault 1 (writing error)
<i>EEP2</i>	13	19	EEPROM fault 2 (reading error)
<i>EEP3</i>	14	20	EEPROM fault 3 (internal fault)
<i>Err2</i>	15	21	RAM fault
<i>Err3</i>	16	22	ROM fault
<i>Err4</i>	17	23	CPU fault
<i>Err5</i>	18	24	Communication error trip
<i>Err7</i>	1A	26	Current detector fault
<i>Err8</i>	1B	27	Optional circuit board type error
<i>UC</i>	1D	29	Small-current trip
<i>UP1</i>	1E	30	Trip due to undervoltage in main circuit
<i>Ot</i>	20	32	Over-torque trip
<i>EF2</i>	22	34	Ground fault trip (hardware detection)
<i>OC1P</i>	25	37	Overcurrent flowing in element during acceleration
<i>OC2P</i>	26	38	Overcurrent flowing in element during deceleration
<i>OC3P</i>	27	39	Overcurrent flowing in element during operation
<i>EtYP</i>	29	41	Inverter type error
<i>OH2</i>	2E	46	External thermal input
<i>SQUt</i>	2F	47	VIA cable break
<i>E-18</i>	32	50	Break in an analog signal cable
<i>E-19</i>	33	51	CPU fault
<i>E-20</i>	34	52	Excess torque boost
<i>E-21</i>	35	53	CPU fault
<i>Et n 1</i>	54	84	Auto-tuning error

## ■ Inverter model (capacity) code (FB05)

---

Model	Data (hexadecimal number)	Data (decimal number)
VFS11-2002PM-AN	1	1
VFS11-2004PM-AN	2	2
VFS11-2007PM-AN	4	4
VFS11-2015PM-AN	6	6
VFS11-2022PM-AN	7	7
VFS11-2037PM-AN	9	9
VFS11-2055PM-AN	A	10
VFS11-2075PM-AN	B	11
VFS11S-2002PL-AN	19	25
VFS11S-2004PL-AN	1A	26
VFS11S-2007PL-AN	1C	28
VFS11S-2015PL-AN	1E	30
VFS11S-2022PL-AN	1F	31
VFS11-4004PL-AN	22	34
VFS11-4007PL-AN	24	36
VFS11-4015PL-AN	26	38
VFS11-4022PL-AN	27	39
VFS11-4037PL-AN	29	41
VFS11-4055PL-AN	2A	42
VFS11-4075PL-AN	2B	43
VFS11-4110PL-AN	2C	44
VFS11-4150PL-AN	2D	45
VFS11-2110PM-AN	6C	108
VFS11-2150PM-AN	6D	109

### 8.3. Control of input/output signals from communication

The input terminals, output terminals, analog input and output signals of the inverters can be controlled by communications.

#### ■ Terminal Output Data (FA50)

The output terminals on the inverters can be controlled directly by communications. Before controlling them, select Function Number 38 to 41 in Output Terminal Function Selection (*F 130 - F 132, F 137, F 138*). Set data (0 or 1) can be output to the output terminals by setting data of Bit 0 and Bit 1 of terminal output data (FA50) by communications.

Data construction of Terminal Output Data (FA50)

Bit	Output Terminal Function	0	1
0	Specified data output 1 (Output terminal selection Number : 38, 39)	OFF	ON
1	Specified data output 2 (Output Terminal Selection Number : 40, 41)	OFF	ON
2 to 15	-	-	-

Example : Controlling only Terminal OUT1 by communication

Set "38" (specified data output 1 [positive logic]) in Output Terminal Selection 1 (*F 130*) in advance and set "0001H" in FA50 to turn Terminal OUT1 on.

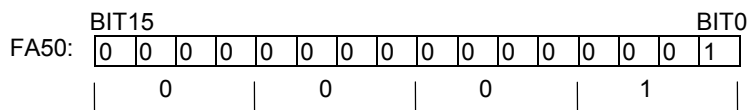

#### ■ Analog Output Data (FA51)

The analog terminals on the inverters, such as Terminal FM can be controlled directly by communications.

Select "18" (communication analog output) in Analog Terminal Connection Selection Parameters (example: FM terminal connection meter selection [*F 151*]) before controlling them.

Data set in Analog Output Data (FA51) can be output from the selected analog terminal. The data adjustment range is 0 to 1023 (10bit resolution). Refer to "Meter Setting and adjustment" in the instruction manual for inverters for the complete information.

## ■ Input terminal board status (FD06, FE06)

Input terminal board status (status immediately before the occurrence of a trip):

Communication Number FE06

Input terminal board status (current status):

Communication Number FD06

In case "0: No assignment function" is selected in function selection, inverter operations will not be affected even when terminals are turned on and off. Therefore, the terminals can be used as input terminals for customer's own use.

The input terminal function selection parameter is used to select a function for each input terminal. When monitoring the operating status, check what function is assigned to each internal terminal.

Data construction of input terminal board (FE06)

Bit	Terminal name (extended)	Function (parameter title)	0	1
0	F	Input terminal selection 1 ( <i>F 111</i> )	OFF	ON
1	R	Input terminal selection 2 ( <i>F 112</i> )	OFF	ON
2	RES	Input terminal selection 3 ( <i>F 113</i> )	OFF	ON
3	S1	Input terminal selection 4 ( <i>F 114</i> )	OFF	ON
4	S2	Input terminal selection 5 ( <i>F 115</i> )	OFF	ON
5	S3	Input terminal selection 6 ( <i>F 116</i> )	OFF	ON
6	VIB *1	Input terminal selection 7 ( <i>F 117</i> )	OFF	ON
7	VIA *1	Input terminal selection 8 ( <i>F 118</i> )	OFF	ON
8 ~ 15	-	-	-	-

\*1: It is valid only when it is selected as contact input by *F 109*.

It is effective only when it is chosen with F109 for input of a contact point.

Ex.: FE06 data when the F and S1 terminals are ON: 0009H

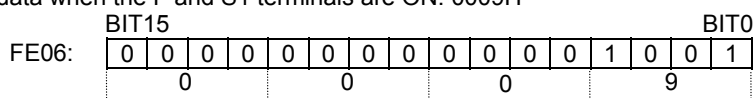

## ■ Output terminal board status (FD07, FE07)

Output terminal board status (status immediately before the occurrence of a trip):

Communication Number FE07

Output terminal board status (current status):

Communication Number FD07

The output terminal function selection parameter is used to select a function for each output terminal. When monitoring the operating status, check what function is assigned to each output terminal.

Data construction of output terminal board (FD07, FE07)

Bit	Terminal name	Function (parameter title)	0	1
0	RY	Output terminal selection1( <i>F 130</i> )	OFF	ON
1	OUT	Output terminal selection1( <i>F 131</i> )	OFF	ON
2	FL	Output terminal selection3( <i>F 132</i> )	OFF	ON
3 ~ 15	-	-	-	-

Ex.: FE07 data when both the RY and OUT terminals are ON: 0003H

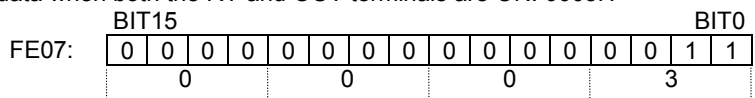



## ■ Analog Input Monitors (FE35, FE36)

---

Analog input value VIA monitor: "Communication Number FE35"

Analog input value VIB monitor: "Communication Number FE36"

Data: 10bit resolution (Data range 0 to 1023)

These monitors can also be used as an A/D converter independent of inverter control.

Setting except for "VIA" as the frequency setting mode will allow analog input (VIA) as an A/D converter independent of inverter control.

Setting other than "VIB" as the frequency setting mode will allow analog input (VIB) as an A/D converter independent of inverter control.

Note, however, input data to analog terminals will be regarded as frequency commands in case analog input is selected in frequency setting mode selection.

## 8.4. Utilizing panel (LEDs and keys) by communication

The VF-S11 can display data that is not related to the inverters through an external controller or other means. Input by key operations can also be executed. The use of inverter resources reduces the cost for the entire system.

### 8.4.1. LED setting by communication

Desired LED information can be displayed by communication.

<How to Set>

Set the standard monitor display selection parameter to "communication LED setting (F710=7)."

When in the standard monitor mode status, LED information is displayed according to the setting of Communication Number FA65. (Is set to Communication Number FA65 = 1 and initial data "dAtA" in shipment setting)

In case of an alarm while setting communication LEDs, the alarm display will alternately display specified LED data and alarm message.

For example, if an over-current alarm (alarm display "C") occurs while "E0.0" is displayed by this function, "C" and "E0.0" will be displayed alternately.

Communication Number.	Parameter Name	Range	Shipment setting
FA65	Select display by communication	0: Numeric data (FA66, FA67, FA68) 1: ASCII data 1 (FA70, FA71, FA72, FA73, FA74) 2: ASCII data 2 (FA75, FA76, FA77, FA78, FA79)	1
FA66	Numeric display data (Enabled if FA65=0)	0-9999	0
FA67	Decimal point position (Enabled if FA65=0)	0: No decimal point (xxxx) 1: First digit below decimal point (xxx.x) 2: Second digit below decimal point (xx.xx)	0
FA68	LED data 0 for unit (Enabled if FA65=0)	0:Hz off, % off, 1:Hz on, % off 2:Hz off, % on, 3:Hz on, % on	0
FA70	ASCII display data 1, first digit from left (Enabled if FA65=1)	0 – 127 (0 – 7FH) (See ASCII LED display code chart)	64H ('d')
FA71	ASCII display data 1, second digit from left (Enabled if FA65=0)	0 – 256 (0 – FFH) (See ASCII LED display code chart)	41H ('A')
FA72	ASCII display data 1, third digit from left (Enabled if FA65=1)	0 – 256 (0 – FFH) (See ASCII LED display code chart)	74H ('t')
FA73	ASCII display data 1, fourth digit from left (Enabled if FA65=1)	0 – 127 (0 – 7FH) (See ASCII LED display code chart)	41H ('A')
FA74	LED data 1 for unit (Enabled if FA65=1)	0:Hz off, % off, 1:Hz on, % off 2:Hz off, % on, 3:Hz on, % on	0
FA75	ASCII display data 2, first digit from left (Enabled if FA65=2)	0 – 127 (0 – 7FH) (See ASCII LED display code chart)	30H ('0')
FA76	ASCII display data 2, second digit from left (Enabled if FA65=2)	0 – 256 (0 – FFH) (See ASCII LED display code chart)	30H ('0')
FA77	ASCII display data 2, third digit from left (Enabled if FA65=2)	0 – 256 (0 – FFH) (See ASCII LED display code chart)	30H ('0')
FA78	ASCII display data 2, fourth digit from left (Enabled if FA65=2)	0 – 127 (0 – 7FH) (See ASCII LED display code chart)	30H ('0')
FA79	LED data 2 for unit (Enabled if FA65=2)	0:Hz off, % off, 1:Hz on, % off 2:Hz off, % on, 3:Hz on, % on	0

## ■ Block Communication Function for LED Display

To display LED data for ASCII display that is synchronized to each digit, set data for each digit and validate this set data by display selection by communication (Communication Number FA65). Synchronization can also be achieved by batch writing LED data parameters after changing the following block communication mode parameters and by sending data by block communication.

Writing in the block communication function will be writing in the RAMs only due to the EEPROM life for write operations. The LED data will reset to the initial value "dAtA" when the power is turned off, in failure resetting or when standard shipment settings are set.

### ■ Parameter Setting

"Block communication mode (Communication Number FA80)"

Setting range: 0, 1 (Initial value 0)

0: Block communication parameters (F870 - F879) is used

1: LED display ASCII data is used (When writing, ASCII display data 1 [Communication Number FA70 - FA74], when reading, LED data displayed before change)

\*To validate LED data set by using LED display block communications, set standard monitor display selection to "communication LED select (F710 = 7) and display selection by communication to "ASCII data 1 (Communication Number FA65).

### ■ Format

The format is the same as that used in the usual block communication mode. (For the detail information, see "4.1.3 Block communication transmission format") The block communication parameters (F870 - F879) will become invalid. Write data will become ASCII display data 1 (Communication Number :FA70 - FA74) fixed. LED display data that is actually being output will be read during reading. The specification range for write operations is 0 to 5.

### ■ Example

Assuming:

Communication LED selection (F710 = 7) for standard monitor display selection.

ASCII data 1 (Communication Number:FA65 = 1) for display selection by communication.

LED display ASCII data (Communication Number: FA80 = 1) for the block communication mode.

Current LED display status is display of initial value "dAtA"

PC → Inverter: 2F580505003000310032003300035A···"0123" display command

Inverter → PC: 2F59050000640041007400410000E7 ··· "dAtA" displayed before change

ASCII LED display data code (00H-1FH are blank.)

Hex Code	Display	Char.	Hex Code	Display	Char.	Hex Code	Display	Char.	Hex Code	Display	Char.
00H	BLANK		20H	BLANK	SP	40H	BLANK	@	60H	BLANK	`
01H	BLANK		21H	BLANK	!	41H		A	61H		a
02H	BLANK		22H	BLANK		42H		B	62H		b
03H	BLANK		23H	BLANK	#	43H		C	63H		c
04H	BLANK		24H	BLANK	\$	44H		D	64H		d
05H	BLANK		25H	BLANK	%	45H		E	65H		e
06H	BLANK		26H	BLANK	&	46H		F	66H		f
07H	BLANK		27H	BLANK		47H		G	67H		g
08H	BLANK		28H		(	48H		H	68H		h
09H	BLANK		29H		)	49H		I	69H		i
0AH	BLANK		2AH	BLANK	*	4AH		J	6AH		j
0BH	BLANK		2BH	BLANK	+	4BH		K	6BH		k
0CH	BLANK		2CH	DGP	,	4CH		L	6CH		l
0DH	BLANK		2DH		-	4DH		M	6DH		m
0EH	BLANK		2EH	DGP	.	4EH		N	6EH		n
0FH	BLANK		2FH		/	4FH		O	6FH		o
10H			30H		0	50H		P	70H		p
11H			31HT		1	51H		Q	71H		q
12H			32H		2	52H		R	72H		r
13H			33H		3	53H		S	73H		s
14H			34H		4	54H		T	74H		t
15H			35H		5	55H		U	75H		u
16H			36H		6	56H		V	76H		v
17H			37H		7	57H	BLANK	W	77H	BLANK	w
18H			38H		8	58H	BLANK	X	78H	BLANK	x
19H			39H		9	59H		Y	79H		y
1AH			3AH	BLANK	:	5AH	BLANK	Z	7AH	BLANK	z
1BH			3BH	BLANK	;	5BH		[	7BH		{
1CH			3CH		<	5CH		\	7CH	BLANK	
1DH			3DH		=	5DH		]	7DH		}
1EH	BLANK		3EH		>	5EH		^	7EH	BLANK	→
1FH	BLANK		3FH	BLANK	?	5FH		_	7FH	BLANK	

\*Dots to show decimal points and other uses can be added by setting (80H) Bit 7 (highest bit).

Example: "0." to display "60.0" can be added by "30H + 80H = B0H."

## 8.4.2.Key utilization by communication

The VF-S11 can use the panel keys on the inverters through external communications. This function is available with CPU version 1 (Communication Number: FE08) = 104 or higher.

### ■ Key Monitoring Procedure

Set panel key selection (Communication Number: FA10) to "1" to set the external key mode. However, if communication duration is less than 1sec to avoid an inverter operation shutdown in communication disruption, communication must always be maintained, such as monitoring key data and LED data to automatically reset inverter operations to inverter key operation (FA10 = 0). Set to the external communication key mode (FA10 = 1) to disable the key function of the inverters so that inverter operation will not be affected by pressing of the keys on the inverters. By monitoring key information, which is input by the keys on the inverters in this condition, through inverter key data (Communication Number; FC01), the keys on the inverters can be operated through a controller and other devices.

\* When the key mode is the external key mode, key operation as an inverter function is disabled and the inverters cannot be stopped by pressing the STOP key to stop inverter operation. Enable emergency stop through an external terminal or other device when an inverter stop is desired.

### Panel Key Selection (Communication Number:FA10)

The panel key selection parameter (Communication Number; FA10) discriminates which keys are to be used, panel keys on the inverters or keys sent by external communications, as panel keys used in panel processing of the inverters.

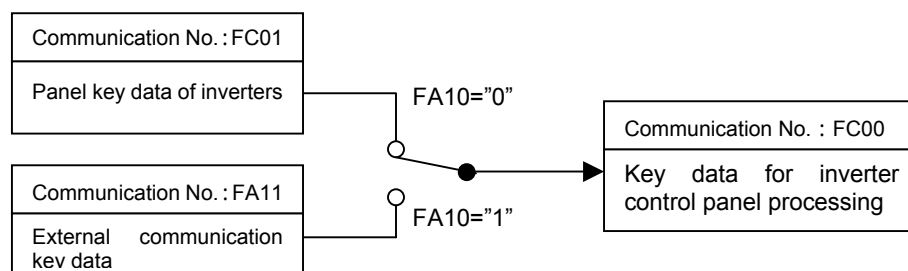

### Keys on inverters enabled (Communication Number: FA10 = 0):

Key data: Data of keys on inverters (Communication Number : FC01)

Bit7	Bit6	Bit5	Bit4	Bit3	Bit2	Bit1	Bit0
KPP	Not defined	ENT	MON	DOWN	UP	STOP	RUN

"KPP" for Bit 7 indicates that panel keys are mounted on the inverters.

### External keys enabled (Communication Number: FA10 = 1):

Key data: External key data (Communication Number: FA11)

Bit7	Bit6	Bit5	Bit4	Bit3	Bit2	Bit1	Bit0
-	-	ENT	MON	DOWN	UP	STOP	RUN

### Key monitoring (Communication Number : FC00):

Information of the enabled keys on the inverters can be monitored.

Bit7	Bit6	Bit5	Bit4	Bit3	Bit2	Bit1	Bit0
KPP	-	ENT	MON	DOWN	UP	STOP	RUN

"KPP" for Bit 7 indicates that panel keys are enabled on the inverters.

## 9.Parameter data

Explanation of parameters for VF-S11 series is described here. For communication purposes, see [the parameter list on inverter's instruction manual](#) regarding the communication number, adjustment range and so forth.

### ■ Referring to the parameter list

<Example of excerpts from the inverter's instruction manual>

Title	Com- muni- cation No.	Function	unit	Minimum setting unit Panel/Com- munication	Adjustment range	Default setting	User setting	Reference
<i>RUH</i>	-	History function	-	-	Displays parameters in groups of five in the reverse order to that in which their settings were changed. * (Possible to edit)	-		4.1.4
<i>RU1</i>	0000	Automatic ac- celera- tion/deceleration	-	-	0: Disabled (manual) 1: Automatic 2:Automatic (only at accelera- tion)	0		5.1.1
<i>RU2</i>	0001	Automatic tor- que boost	-	-	0:Disabled 1:Automatic torque boost + autotuning 2:Vector control + auto-tuning 3:Energy saving + auto-tuning	0		5.2
					:			
					:			
<i>RL1</i>	0009	Acceleration time1	S	0.1/0.1	0.0-3200	10.0		5.1.2
					:			

- The summary of parameter list relating to the communication is as follows.

- (1) "Title" means the display on the inverter panel.
- (2) "Communication number" is affixed to each parameter that is necessary for designating the parameter for communication.
- (3) "Adjustment range" means a data range adjustable for a parameter, and the data cannot be written outside the range. The data have been expressed in the decimal notation. For writing the data through the communication function, take the minimum setting unit into consideration, and use hexadecimal system.
- (4) "Minimum setup unit" is the unit of a single data (when the minimum unit is "-", 1 is equal to 1).  
For example, the "minimum setup unit" of acceleration time (*RL1*) is 0.01, and 1 is equal to 0.01s. For setting a data to 10 seconds, transmit 03E8h [ $10 \div 0.01=1000d=03E8h$ ] by communication.

## ■ Command parameters

For those parameters that contain data only in the RAM and not in the EEPROM, their data return to initial values when the power is turned off, in failure resetting, or when standard shipment settings are set. Note that parameters without data storage in the EEPROMs will be written in the RAMs only even if the command W (writing in EEPROMs and RAMs) is executed.

### ■ Commands

NOTE : Data is expressed in decimal notation.

Communication Number.(HEX)	Function	Adjustment Range	Min. Setting Unit	Initial Value	Write During Operator	EEP ROM
FA00	Command 1 (Communication) *1	0 to 65535	-	0	yes	None
FA01	Operation frequency command value (Communication) *1	0 to Max. frequency (FH)	0.01Hz	0	yes	None
FA03	Operation frequency command value (Panel) *2	Low-limit frequency (LL) to High-limit frequency (LL)	0.01Hz	0	yes	Available
FA10	Panel key selection *4	0 to 1	-	0	yes	None
FA11	External communication key data *4	0 to 65535	-	0	yes	None
FA20	Command 2 (Communication) *1	0 to 65535	-	0	yes	None
FA26	Command 3 (Communication) *1	0 to 65535	-	0	yes	None
FA50	Terminal output data *3	0 to 65535	1	0	yes	None
FA51	Analog output data *3	0 to 1023 (10-bit resolution)	1	0	yes	None
FA65	Select display by communication *4	0 to 2	-	1	yes	Available
FA66	Numerical display data *4	0-9999	1	0	yes	Available
FA67	Decimal point position *4	0 to 2	-	0	yes	Available
FA68	LED data for unit 0 *4	0 to 3	-	0	yes	Available
FA70	ASCII display data 1 First digit from left *4	0 to 127	-	100 ('d')	yes	Available
FA71	ASCII display data 1 Second digit from left *4	0 to 255	-	65 ('A')	yes	Available
FA72	ASCII display data 1 Third digit from left *4	0 to 255	-	116 ('t')	yes	Available
FA73	ASCII display data 1 Fourth digit from left *4	0 to 127	-	65 ('A')	yes	Available
FA74	LED data for unit1 *4	0 to 3	-	0	yes	Available
FA75	ASCII display data 2 First digit from left *4	0 to 127	-	48 ('0')	yes	Available
FA76	ASCII display data 2 Second digit from left *4	0 to 255	-	48 ('0')	yes	Available
FA77	ASCII display data 2 Third digit from left *4	0 to 255	-	48 ('0')	yes	Available
FA78	ASCII display data 2 Fourth digit from left *4	0 to 127	-	48 ('0')	yes	Available
FA79	LED data for unit 2 *4	0 to 3	-	0	yes	Available
FA80	Block communication mode *4	0 to 1	-	0	yes	Available

\*1: Enable the communication command or communication frequency setting before setting these parameters are set. Otherwise, the parameters will not function. See "8.1 Command by communication" for the method to enable them.

\*2: Note that the Communication Number for operation frequency command values (panel) is FA02 in the VF-S7 and VF-S9 series.

\*3: See "8.3 Control of input/output signals from communication" for the detail information.

\*4: See "8.4 Utilizing panel (LEDs and keys) by communication" for the detail information.

■ Monitor parameters \* These parameters are read-only (monitor-only) parameters.

Communication No.	Title	Function	Unit	Remarks
FC00	-	Monitor of key data (Effective data)	-	See 8.4.
FC01	-	Monitor of inverter keypad data	-	See 8.4.
FC90	-	Trip code	-	See 8.2.
FC91	-	Alarm code	-	See 8.2.
FD00	-	Operation frequency (current frequency)	0.01Hz	
FD01	-	Inverter status (current status)	-	See 8.2.
FD06	-	Input terminal information (current information)	-	See 8.3.
FD07	-	Output terminal information (current information)	-	See 8.3.
FD42	-	Inverter status2 (current status)	-	See 8.2.
FD49	-	Inverter status3 (current status)	-	See 8.2.
FE00	-	Operation frequency <sup>*5</sup>	0.01Hz	
FE01	-	Inverter status <sup>*5</sup>	-	See 8.2.
FE02	-	Operation frequency command (actual instruction) <sup>*5</sup>	0.01Hz	
FE03	-	Load current	0.01%	
FE04	-	Input Voltage	0.01%	
FE05	-	Output voltage <sup>*5</sup>	0.01%	
FE06	-	Input terminal information <sup>*5</sup>	-	See 8.3.
FE07	-	Output terminal information <sup>*5</sup>	-	See 8.3.
FE08	-	CPU1 version	-	
FE09	-	EEPROM version	-	
FE10	-	Past trip 1	-	See 8.2.
FE11	-	Past trip 2	-	See 8.2.
FE12	-	Past trip 3	-	See 8.2.
FE13	-	Past trip 4	-	See 8.2.
FE14	-	Cumulative operation time	1H	
FE15	-	Primary frequency (compensated frequency) <sup>*5</sup>	0.01Hz	
FE16	-	Estimated motor operation frequency <sup>*5</sup>	0.01Hz	
FE18	-	Torque	0.01%	
FE20	-	Torque current <sup>*5</sup>	0.01%	
FE21	-	Excitation current <sup>*5</sup>	0.01%	
FE22	-	Analog (VIA) input frequency <sup>*5</sup>	0.01Hz	
FE26	-	Motor (Electronic-thermal) load factor <sup>*5</sup>	1%	
FE27	-	Inverter load factor <sup>*5</sup>	1%	
FE29	-	Input power	0.01KW	
FE30	-	Output power <sup>*5</sup>	0.01KW	
FE35	-	Analog input value VIA 10-bit resolution (data range: 0 to 1023)	-	See 8.3.
FE36	-	Analog input value VIB 10-bit resolution (data range: 0 to 1023)	-	See 8.3.
FE42	-	Inverter status2	-	See 8.2.
FE45	-	Command mode(CMOD) status	-	See 8.2.
FE46	-	Frequency mode(FMOD) status	-	See 8.2.
FE49	-	Inverter status3	-	See 8.2.
FE70	-	Rated current	0.1A	
FE71	-	Rated voltage	0.1V	
FE73	-	CPU2 version	-	
FE75	-	monitor of inverter number Hard SW	-	
FE76	-	Integral Input power	0.01kWh	
FE77	-	Integral Output power	0.01kWh	
FE79	-	Life alarm information	-	See 8.2.
FE80	-	Cumulative power-on time	1H	

\*5: If a trip occurs, data immediately before its occurrence is displayed.



## Appendix 1 Table of data codes

### • JIS (ASCII) codes

Higher order Lower order	0	1	2	3	4	5	6	7
0	NUL	TC <sub>7</sub> (DLE)	(SP)	0	@	P	,	p
1	TC <sub>1</sub> (SOH)	DC <sub>1</sub>	!	1	A	Q	a	q
2	TC <sub>2</sub> (STX)	DC <sub>2</sub>	"	2	B	R	b	r
3	TC <sub>3</sub> (ETX)	DC <sub>3</sub>	#	3	C	S	c	s
4	TC <sub>4</sub> (EOT)	DC <sub>4</sub>	\$	4	D	T	d	t
5	TC <sub>5</sub> (ENQ)	TC <sub>8</sub> (NAK)	%	5	E	U	e	u
6	TC <sub>6</sub> (ACK)	TC <sub>9</sub> (SYN)	&	6	F	V	f	v
7	BEL	TC <sub>10</sub> (ETB)		7	G	W	g	w
8	FE <sub>0</sub> (BS)	CAN	(	8	H	X	h	x
9	FE <sub>1</sub> (HT)	EM	)	9	I	Y	i	y
A	FE <sub>2</sub> (LF)	SUB	*	:	J	Z	j	z
B	FE <sub>3</sub> (VT)	ESC	+	;	K	[	k	{
C	FE <sub>4</sub> (FF)	IS <sub>4</sub> (FS)	,	<	L	¥	l	
D	FE <sub>5</sub> (CR)	IS <sub>3</sub> (GS)	-	=	M	]	m	}
E	SO	IS <sub>2</sub> (RS)	.	>	N	^	n	
F	SI	IS <sub>1</sub> (US)	/	?	O	_	o	DEL

CR: Carriage return

Ex.: Code 41 = Character A

## Appendix 2 Response time

The communication response time can be calculated from data communication time and inverter processing time. When wishing to know the communication response time, calculate using the following as a reference

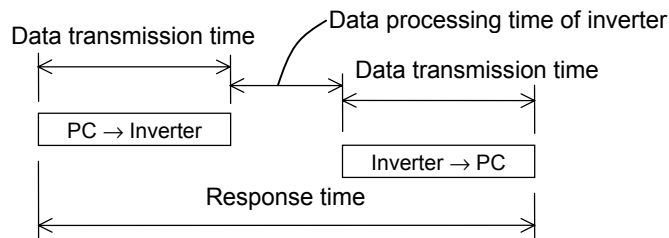

### ■ Data transmission time

$$\text{Data transmission time} = \frac{1}{\text{baud rate}} \times \text{number of bytes transmitted} \times \text{number of bits}$$

\* Number of bits = start bit + data frame length + parity bit + stop bit

\* Minimum number of bits = 1 + 8 + 0 + 1 = 10 bits

\* Maximum number of bits = 1 + 8 + 1 + 2 = 12 bits

<An example of the calculation of the transmission time: 19200 bps, 8 bytes, 11 bits>

$$\text{Data transmission time} = \frac{1}{19200} \times 8 \times 11 = 4.6\text{ms}$$

### ■ Data processing time of inverter

Data processing time: maximum 20ms

## Appendix 3 Compatibility with the communications function of the VF-S9

To provide consistency in communications procedures, the communications function of the VF-S11 series of inverters has been designed based on the protocols used for the Toshiba VF-S9 series of inverters. With regard to compatibility, however, VF-S9 users should check the items described below before using the communications function of their inverters.

### ■ To VF-S9 inverter users:

Some parameters of the VF-S9 are different from those of the VF-S11 in function or adjustment range (upper and lower limits), even though they have the same title or the same communication number. So, when accessing a parameter, consult the VF-S9 inverter's instruction manual to see if the parameter is identical to the corresponding parameter of the VF-S11. If the parameter differs, modify the computer program to suit your inverter. To avoid hazards, never copy parameters from one model of inverter to another.

### ■ Comparison of communication-related items

The table below gives a comparison of communication-related items to be kept in mind when replacing VF-S9 inverters with VF-S11 inverters or when connecting VF-S9 inverters and VF-S11 inverters to the same network. It does not cover any items common to the VF-S9 and VF-S11 series of inverters.

Item \ Model	VF-S9	VF-S11	Reference
Data processing time of inverter	About 8 ms (This is only standard time, not guarantee time.)	maximum 20ms	Appendix 2

## Notice

- ◆ Do not use communications programs written for another series of inverters.  
Even though parameters have the same title and the same communication number, they may be different in function. When using a parameter, always check its specifications in the instruction manual for your inverter. If the specifications of the parameter differ, modify the computer program to suit your inverter.
- ◆ To avoid hazards, do not copy parameters from one model of inverter to another.  
Even though parameters have the same titles and communication numbers, they may be different in function.

## Appendix 4 Troubleshooting

If a problem arises, diagnose it in accordance with the following table before making a service call. If the problem cannot be solved by any remedy described in the table or if no remedy to the problem is specified in the table, contact your Toshiba dealer.

Problem	Remedies	Reference
Communications will not take place.	<ul style="list-style-type: none"> <li>- Are both the computer and the inverter turned on?</li> <li>- Are all cables connected correctly and securely?</li> <li>- Are the same baud rate, parity and bit length set for every unit on the network?</li> </ul>	Chapter 7
An error code is returned.	<ul style="list-style-type: none"> <li>- Is the data transmission format correct?</li> <li>- Does the data written fall within the specified range?</li> <li>- Some parameters cannot be written during inverter operation. Changing should be attempted when the inverter is in halt.</li> </ul>	Section 4.1 Section 5.1 Chapter 9 Inverter instruction manual
The trip $\overline{ERR5}$ occurs.	<ul style="list-style-type: none"> <li>- Check the cable connection and the timer setting.</li> </ul>	Section 7.3
The slave of " Inter-drive communication " did an $\overline{ERR5}$ trip.	<ul style="list-style-type: none"> <li>- Is a communication waiting time parameter on the master side set up? Set bigger value than present value on the master's transmitting interval.</li> </ul>	Chapter 6 Section 7.4
Frequency instructions from the computer have no effect.	<ul style="list-style-type: none"> <li>- Is the frequency setting mode selection parameter set to "computer"?</li> </ul>	Section 8.1
Commands, including the run and stop commands, from the computer have no effect.	<ul style="list-style-type: none"> <li>- Is the command mode selection parameter set to "computer"?</li> </ul>	Section 8.1
A change to a parameter does not take effect.	Some communications-related parameters do not take effect until the inverter is reset. To make them take effect, turn the inverter off temporarily, then turn it back on.	Chapter 7
The setting of a parameter was changed, but it returns to its original setting when the inverter is turned off.	When using the TOSHIBA Inverter Protocol, use the W command to write data into the EEPROM. If you use the P command that writes data into the RAMs only, the data will be cleared when the inverters are reset.	Section 4.2