

TOSVERT VF-FS1 series

Metasys[®] N2 option unit Instruction Manual

MTS002Z

NOTICE



1. Make sure that this instruction manual is delivered to the end user of Metasys[®] N2 option unit.
2. Read this manual before installing or operating the Metasys[®] N2 option unit. Keep it in a safe place for reference.
3. All information contained in this manual are subject to change without notice. Please confirm the latest information on our web site "www.inverter.co.jp".

Safety precautions

On the inverter and in its instruction manual, important information is contained for preventing injuries to users, damages to assets, and for proper use of the device.

Read the instruction manual attached to the inverter along with this instruction manual to completely understand the safety precautions, the symbols and indications shown below. Please adhere to the contents of these manuals at all times.





Explanation of markings

Marking	Meaning of marking
 Danger	Indicates that errors in operation may lead to death or serious injury.
 Warning	Indicates that errors in operation may lead to injury (*1) to people or that these errors may cause damage to physical property. (*2)

(*1) Such things as injury, burns or shock that will not require hospitalization or long periods of outpatient treatment.

(*2) Physical property damage refers to wide-ranging damage to assets and materials.

Meanings of symbols

Marking	Meaning of marking
	Indicates prohibition (Do not do it). What is prohibited will be described in or near the symbol in either text or picture form.
	Indicates something mandatory (must be done). What is mandatory will be described in or near the symbol in either text or picture form.
	Indicates danger. What is dangerous will be described in or near the symbol in either text or picture form.
	Indicates warning. What the warning should be applied to will be described in or near the symbol in either text or picture form.



■ Limitation of use

Safety precaution

- ▼ Never use this unit with any device other than TOSVERT VF-FS1 series inverters. Doing so may cause an accident.

■ Handling in general

Danger



 Never Disassemble	<ul style="list-style-type: none"> ▼ Never disassemble, modify or repair the product. Disassembling the product may cause electric shocks, fire or injuries. For repairs, call your sales/repair agency.
 Prohibited	<ul style="list-style-type: none"> ▼ Do not open the front cover on the inverter while the inverter power is on. It may lead to electric shocks. ▼ Do not remove this option from VFFS1 while the power is on. It may lead to electric shocks. ▼ Do not put or insert foreign objects such as waste cable, bars or wires into the product. It may lead to electric shocks or fire. ▼ Do not splash water over the product, and do not wipe the body with a wet cloth. It may lead to electric shocks or fire.
 Mandatory	<ul style="list-style-type: none"> ▼ Turn off the power immediately in case of any abnormalities such as smoke, smell or abnormal noise. Neglect of these conditions may lead to fire. For repairs, call your sales/repair agency. ▼ Do not touch the sharp portions (such as leads of parts on the board, the corner of board, or etc.) on this option. It may lead to injuries.

Warning



 Mandatory	<ul style="list-style-type: none"> ▼ This option is an electrostatic discharge sensitive device. Handle it, where the environment is protected against electrostatic electricity. Otherwise, permanent damage to device will result.
--	---

■ Transportation and installation





Danger

 Prohibited	<ul style="list-style-type: none"> ▼ Do not apply a dropping shock or other physical shocks. Otherwise, damage or malfunction will result. ▼ Do not install or operate the inverter if it is damaged or any part of it is missing. Operating a defective inverter may lead to electric shocks or fire. For repairs, call your sales/repair agency. ▼ Do not put any flammable material near the product. It may catch fire due to the product sparking in the case of a malfunction.
 Mandatory	<ul style="list-style-type: none"> ▼ Use this product under the environmental conditions prescribed in the instruction manual. Usage it under any other conditions may result in malfunction. ▼ An emergency stop device must be installed that fits with system specifications (e.g. shut off input power then engage mechanical brake). Operation cannot be stopped immediately by the inverter or this unit alone, thus risking an accident or injuries. ▼ Install this option into VFFS1 and secure it by tightening the terminal board fixing screws to the specified torque. Otherwise, it may cause the product falling, the damage, or malfunctions. ▼ Install insulated sheet (attached) under this option. Otherwise, permanent damage to device will result.



■ Wiring

 Warning	
 Mandatory	<ul style="list-style-type: none"> ▼ Electrical construction work must be done by a qualified expert. Connection of input power by someone who does not have expert knowledge may result in electric shocks or fire. ▼ Turn off input power before wiring. Wait at least 10 minutes and make sure that the charge lamp (on the inverter unit) is no longer lit. Otherwise, it may lead to electric shocks. ▼ Tighten the screws on the terminal blocks to the specified torque when connecting cables to terminal blocks. Otherwise, it may lead to fire.

■ Operations

 Danger	
 Prohibited	<ul style="list-style-type: none"> ▼ Do not pull on the cable and connector. It may cause damage or malfunctions.
 Mandatory	<ul style="list-style-type: none"> ▼ Use this option under the environment specified in the instruction manual. Usage under the environment other than them may cause damages or malfunctions or an accident. ▼ Use an additional safety device with your inverter or system to prevent a serious accident due to the unit malfunctions. Usage without an additional safety device may cause an accident.
 Warning	
 Mandatory	<ul style="list-style-type: none"> ▼ Set up “Communication error trip function (see below)” to stop the inverter when the option unit is deactivated by an unusual event such as an operating error, power outage, failure, etc. <ul style="list-style-type: none"> - Communication error trip time (Between the inverter and option board) (<i>F803</i>) - Network timeout (<i>F892</i>) (See the VFFS1 Metasys® N2 Communication Function Manual for details.) Deactivated option unit may cause an accident, if the “Communication error trip function” is not properly set up. ▼ Make sure that the operation signals are STOP before resetting inverter’s fault. The motor may suddenly start and that may result in injuries.

■ Disposal

 Warning	
 Mandatory	<ul style="list-style-type: none"> ▼ If you dispose off this unit, have it done by a specialist in industrial waste disposal*. Improper disposal may result in explosion of capacitors or produce noxious gases, resulting in injuries. (*) Persons who specialize in the processing of waste and known as “Industrial Waste Product Collectors and Transporters” or “Industrial Waste Disposal Persons.” If the collection, transport and disposal of industrial waste is done by someone who is not licensed for that job, it is a punishable violation of the law (Laws in regard to cleaning and processing of waste materials).

■ Notes on operation

Notes	
	<ul style="list-style-type: none"> ▼ Avoid installing in a place where ambient temperature or/and humidity change sharply. ▼ Keep the transmission cable separate from the power cable of the inverter to prevent the inverter from malfunctioning due to electromagnetic noise. ▼ Ground of SCR terminal on this option at the grounding terminal separated from those of inverters and motors. It may cause malfunction due to noise.

Table of Contents

- 1. Overview6
- 2. Names and functions.....6
 - 2.1. Outline.....6
 - 2.2. Use of RS485 communication port.....6
 - 2.3. LED indicator.....7
- 3. Installation and Setup.....7
 - 3.1. Installation method7
 - 3.2. Description of terminals.....9
 - 3.3. Network cable connection10
 - 3.4. Network configuration.....10
 - 3.5. Wiring of a control terminal.....11
- 4. Parameters.....12
 - 4.1. Communication parameters12
- 5. Specifications13
- 6. Warranty.....14

1. Overview

The Metasys® N2 interface (MTS002Z) allows the VFFS1 inverter to be connected into a Metasys® N2 network.

2. Names and functions

The drawing below shows names and functions of main parts.

2.1. Outline

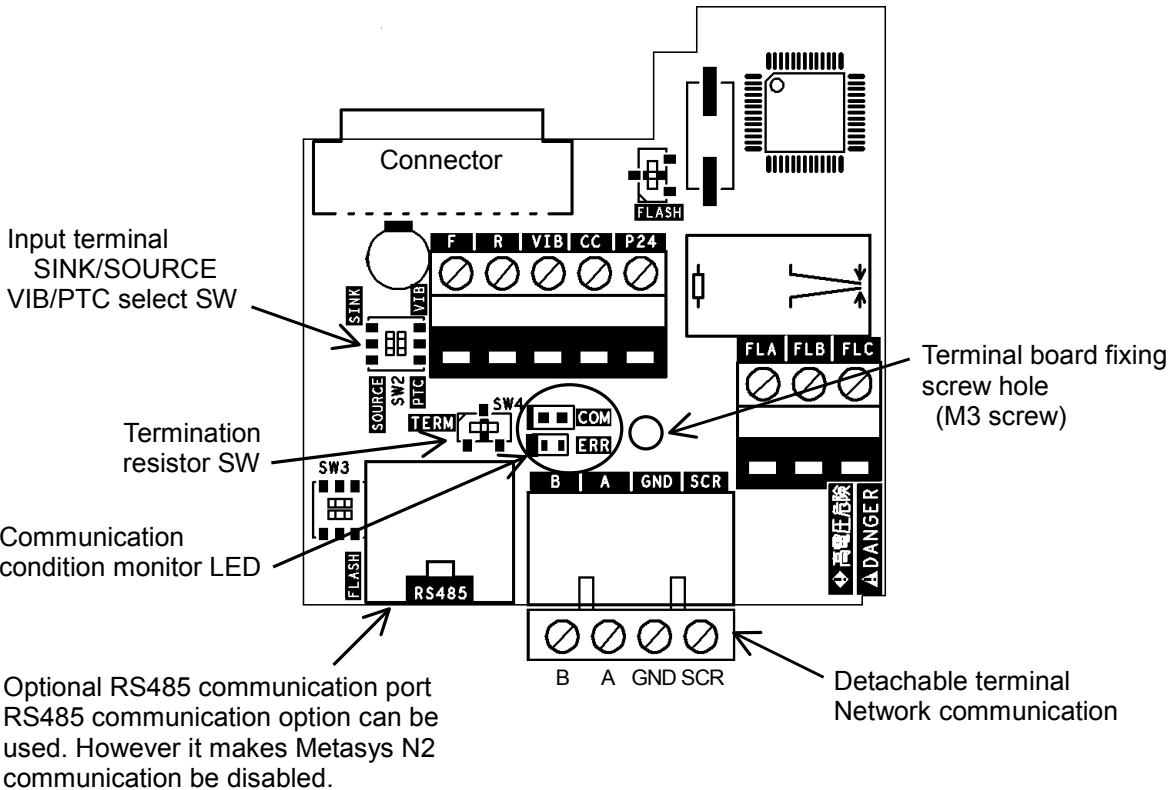

2.2. Use of RS485 communication port

Serial communication (2-wire RS485) option can be used. However, while it is connected, the internal communication line is switched to RS485 then the communication via Metasys® N2 network is disabled. In this case, communication error trip time (*F803*) is also active. Use RS485 serial communication option specified by Toshiba.

2.3. LED indicator

The option has two LEDs. Those function are below table.

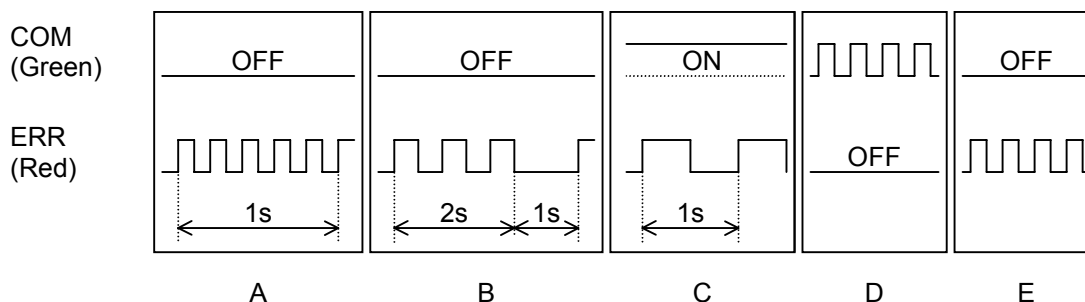

State	LEDs	Comment
A	COM LED: OFF ERR LED: Flashing 5 times in 1 second	MTS002Z failure.
B	COM LED: OFF ERR LED: 3 times in 2 seconds, Off for 1 second	Communication loss detected. Confirm the network condition and connection of the cable.
C	COM LED: ON ERR LED: OFF 0.5s, ON 0.5s	Invalid configuration detected, or a option is connected to RJ45.
D	COM LED: Flashing ERR LED: -	Valid message received for this node
E	COM LED: - ERR LED: Flashing	Invalid message received (any node)

3. Installation and Setup

3.1. Installation method

Install the MTS002Z to VFFS1 as follows.

- (1) Turn off the input power of VFFS1 and wait for at least 10 minutes and then check that the CHARGE lamp on VFFS1 is no longer lit.
- (2) Open the VFFS1 front cover, remove the terminal board fixing screw and take off the VFFS1 standard terminal board.
(Be careful not to lose the terminal board fixing screw when removed since it may be used again.)
- (3) Perform wiring an inverter before installing MTS002Z.
- (4) Please attach the insulating sheet in VFFS1.
(Fix to the terminal board fixing screw hole and PWB catch pin.)
- (5) Install the MTS002Z over the insulating sheet and secure it with the board fixing screw (tightening torque of M3 tapping screw: 0.7 to 0.8Nm).
- (6) Set up the SW of the board with the input terminal for sink or source.
- (7) Stick the cabling label for MTS002Z on the standard cabling label stuck on the reverse side of the VFFS1 front cover. And stick the MTS002Z nameplate near the standard nameplate. (Be careful not to cover slits on the VFFS1 enclosure.

N.B.: To install or remove the terminal board, make it slide in or out in parallel with board.

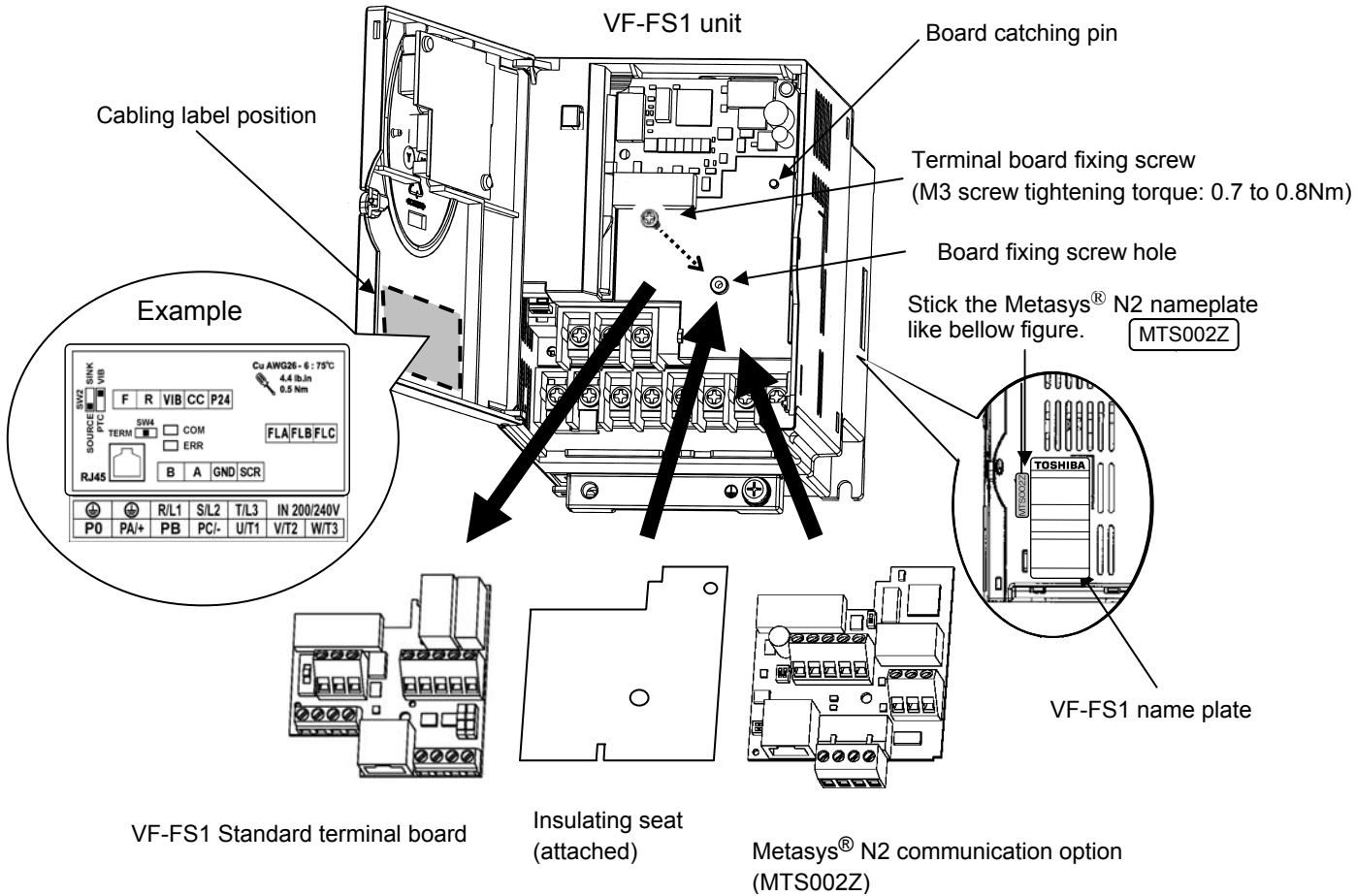

⚠ Danger	
⚠ Mandatory	▼ Install insulated sheet (attached) under this option. Otherwise, permanent damage to device will result.

3.2. Description of terminals

<Control terminals specification>

Terminal symbol	Function	Electrical specifications	Internal circuits
B	Metasys® N2 communication signal EIA-485	Communication signal (+)	
A		Communication signal (-)	
GND		Signal common	
SCR		Shield terminal. Connect to network ground.	
F	Multifunctional programmable contact input.	No voltage contact input 24V _{DC} , 5mA or less	
R	SINK/SOURCE can be selected with SW.	N.B. Use contact parts for low current.	
VIB	Multifunction programmable analog input. with internal pull-up resistor for PTC	0 to 10V _{DC} input Using this terminal as PTC input, set SW2 to PTC side and set the parameters (F545 and F546) to proper value.	
CC	Control circuit's equipotential terminal		
P24	24 V _{DC} power supply output	24V _{DC} -50mA	
FLA FLB FLC	Multifunctional programmable relay contact outputs	1c contact 30V _{DC} -0.5A 250V _{AC} -1A (cosφ =1) 250V _{AC} -0.5A (cosφ =0.4)	

Danger

 Prohibited	<p>▼ Do not change switches settings while the power is on. It may lead to electric shocks or damage.</p>
 Mandatory	<p>▼ Turn off the motor operation signals before setting the parameter and the switch (SW), when changing the VIB function. Otherwise, the motor may suddenly start and that may result in injuries.</p>

3.3. Network cable connection

Connect the Metasys® N2 network cable to communication option as follows.

Title	Description
Wire type	Shielded twisted cable
Characteristic impedance	Between 100 and 130 ohm
Distributed impedance between conductors	Less than 100pF per meter
Distributed impedance between conductors and shield	Less than 200pF per meter Foil or braided shield are acceptable.
Length of an MSTP segment	1200 meters with AWG18 (0.8mm ²)

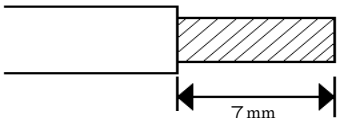

Cable sheath should be peeled off by about 7mm.
 For wiring work, use a flat blade screwdriver with a 0.6mm thick and 3.5mm width blade.
 Tightening torque for the terminal block is 0.5Nm.

* Fix a cable so that a communication connector may be not taken the weight of wire.

3.4. Network configuration

Make up the network as follows.

- Transmission/reception signals (A, B)
 Make up the communication path by connecting all transmission/reception data cables.
- Signal common (GND)
 GND is the signal common.
- Grounding the shield of cable (SCR)
 Connect the all shield lines of network cable. The shield shall be grounded at one end only prevent currents from being created.
- Termination resistor
 A termination resistance of 120 ohms plus or minus 5% shall be connected at each of the two ends of the segment medium. This option has a termination resistor, so if use, set up the termination resistor SW. (Refer to 2.1 Outline)
 At least one set, and no more than two sets, of network bias resistors shall exist for each segment. This option has local bias resistors.

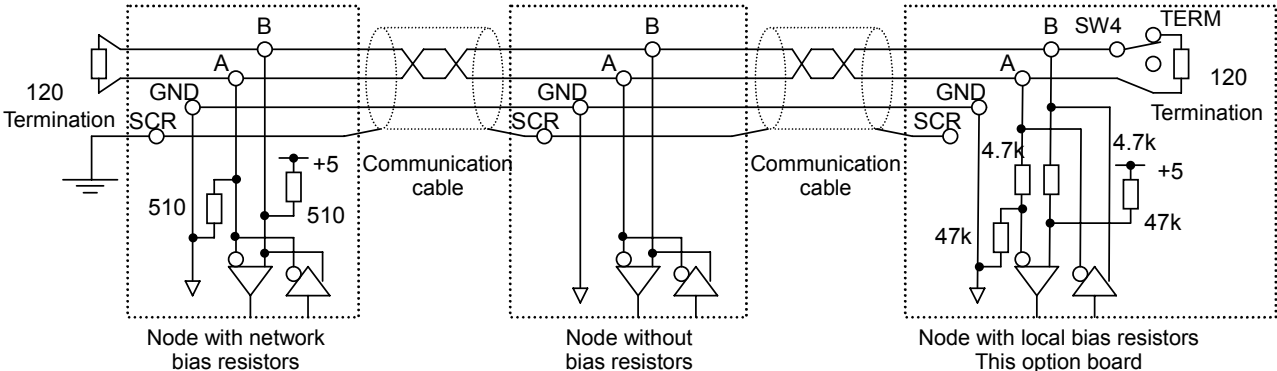

N.B.: Do not connect the SCR terminal to the power ground of inverters or other units.
 Keep the network cables 20cm or more separate from the power cables to prevent from malfunctioning due to electromagnetic noise.

3.5. Wiring of a control terminal

Observe the following when wiring.

- Use 0.3 to 1.5mm² solid/stranded wire (AWG 22 to 16) for control cables.
- Remove the sheath of a cable about 7mm (6mm for FLA, FLB, FLC and G/E) from the end of cable.
- Use a flat-headed screwdriver with its blade 0.6mm in thickness and 3.5mm in width.
- Screw tightening torque for the terminal block screws should be 0.5 to 0.6Nm.

N.B.: Keep the control signal cables 20cm or more separate from the power cables to prevent from malfunctioning due to electromagnetic noise.

N.B.: Provide an inter-lock system stated in below, when using a programmable controller that has the open collector output.

When the programmable controller is turned off with the inverter is on, the difference between each control power potential will cause wrong signals to the inverter as shown in below figure. Provide an inter-lock so that the programmable controller cannot be turned off when the inverter power is alive.

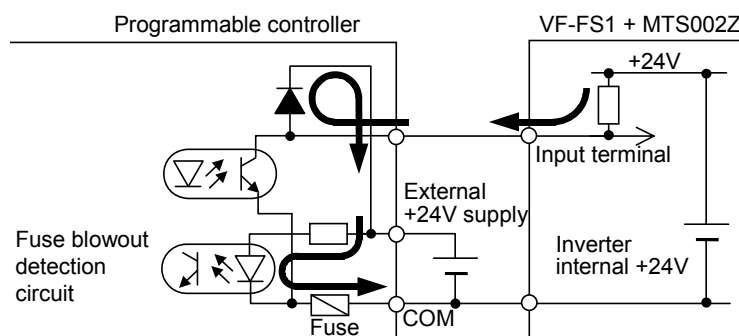

4. Parameters

4.1. Communication parameters

Set up the inverter parameters as follows. To update, reset the power of inverter. If these parameters are not set to correct value, this unit can not work normally.

Title	Function	Description	MTS002Z
<i>F800</i>	Communication rate	Set "1: 19200bps" (default).	1
<i>F801</i>	Parity	Set "1: Even" (default).	1
<i>F803</i>	Communication error trip time	Set communication time out period.	0
<i>F829</i>	Communication protocol	0: Toshiba inverter protocol 1: Modbus protocol 2: Metasys® N2 protocol 3: APOGEE FLN protocol 4: BACnet protocol	2
<i>F851</i>	Operation at communication error by disconnection	0: Inverter stop, communication command, frequency mode open (by <i>CNOd</i> , <i>FNOd</i>) 1: None (continued operation) 2: Deceleration stop 3: Coast stop 4: Communication error (<i>E r r 5</i> trip) or Network error (<i>E r r 8</i> trip)	-

Title	Function	Description	MTS002Z
<i>F890</i>	Address	Set node address	0 - 255
<i>F892</i>	Network Time-Out	0: No action Unit 0.1 sec, Setting range: 1 - 65535	-
<i>F897</i>	Version	The software version of MTS002Z	(100)

* When *FNOd* or *CNOd* is set to "Serial Communication", VFFS1 drives without FRCMDMOD (Binary Output Object - 11) or RSCMDMOD (Binary Output Object - 10) at each Objects.

Warning



- ▼ Set up "Communication error trip function (*F803*, see the inverter instruction manual for details)" to stop the inverter when this option unit is deactivated by an unusual event such as tripping, an operating error, power outage, failure, etc. Deactivated option unit may cause an accident, if the "Communication error trip function" is not properly set up.

5. Specifications

< Environmental specification >

Item	Specification
Service environment	Conforms to VFFS1
Operation temperature	Conforms to VFFS1
Storage temperature	-25 to +65°C
Relative humidity	20 to 93% (free from condensation and vapor)
Vibration	5.9m/s ² (0.6G) or less (10 to 55 Hz) (To be complied with JIS C0040.)

< MTS002Z terminal specification >

Item	Specification	Note
Communication between inverter	VFFS1	Only one board connection is available.
Applicable model		
Communication method	MODBUS-RTU	Set the inverter parameter
Baud rate	19200bps	
Parity	Even number	
Control power supply	5 V _{DC}	Supplied from inverter
Logic input terminal	2 circuits (F,R) Slide switch (SW) enable to select logical configurations (Source/Sink).	Not isolated
Logic output terminal	Nothing	
Relay contact output terminal	1 circuit (FL): 30V _{DC} -0.5A 250V _{AC} -1A (cosφ = 1) 250V _{AC} -0.5A (cosφ = 0.4)	Isolated
Analog input terminals	1 circuit (VIB): 10V _{DC} (R _{IN} = 30kohm)	Not isolated
Analog output terminals	Nothing	
Power supply output	24V _{DC} -50mA	Current limit function

< MTS002Z network specification >

Item	Specification
Maximum node	255 nodes (32 nodes per segment)
Communication baud rate	9600bps
Bias resistor and termination	Local bias resistors are mounted. Termination resistor (120 ohm) can be select by SW.
Terminal block	Detachable terminal block 4-pole (5.08mm pitch) Manufacturer: PHOENIX CONTACT Type-Form : MSTB 2,5/4-ST-5.08

6. Warranty

Any part of Metasys® N2 communication option that is proved to be defective will be repaired free of charge under the following conditions:

1. This product will be repaired free of charge, if problem/fault occurs under normal handling within one year of delivery and is caused obviously by a design or manufacturing defect.
2. The warranty applies only to the delivered product.
3. For the following kinds of failure or damage, the repair cost shall be borne by the customer even within the warranty period.
 - i) Failure or damage caused by improper or incorrect use or handling, or unauthorized repair or modification of the inverter.
 - ii) Failure or damage caused by the unit falling or an accident during transportation after the purchase.
 - iii) Failure or damage caused by fire, salty water or wind, corrosive gas, earthquake, storm or flood, lightning, abnormal voltage supply, or other natural disasters.
 - iv) Damage due to the use of Metasys® N2 communication option for non-intended purposes.
4. If an additional warranty is provided then those conditions will also apply.