TOSVERT VF-AS1

Torque control Instruction Manual

Toshiba Schneider Inverter Corporation

The technical information in this manual is provided to explain the principal functions and applications of the product, but not to grant you a license to use the intellectual property or any other property of Toshiba Schneider Inverter Corporation or a third party.

— Contents —

1. Torque control	2
2. What is torque control?	3
3. Torque control setting	4
4. Concepts regarding torque control	8
4.1 Applied to application where the direction of rotation does not change.....	8
4.2 Applied to application where the direction of rotation changes.....	10
5. Speed limits in torque control mode.....	11
6. Setting motor constants	13

1. Torque control

TOSVERT VF-AS1 supports the torque control that controls a power necessary for constant tension control such as winding control as well as speed control that controls the revolution of a motor.

TOSVERT VF-AS1 can use the control methods below:

- Sensorless vector control : VF-AS1 inverter only
- Vector control with sensor : VF-AS1 + encoder feedback option
(VEC004Z to 007Z)

* For a machine requiring torque accuracy, use the vector control with sensor (parameter: $P_{t=0}$).

2. What is torque control?

A combination of an inverter and a motor generally uses speed control. As shown below, it gives an inverter a command of a desired rotational speed so that the inverter can control the motor to rotate at the speed as commanded.

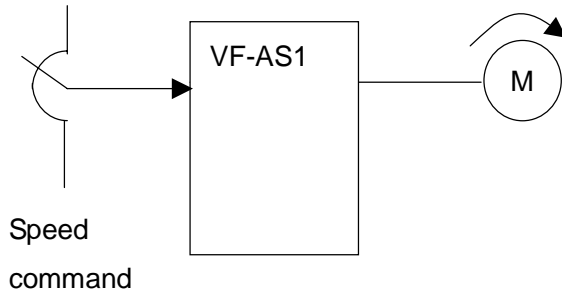

Main application	
Group	Examples
Wind/water power machines and compress machine	Fan, blower, pump, air-conditioning system, clean room, dryer and compressor, etc.
Distribution, conveyance and transport machines	Crane, winding machine, conveyer, 3-dimensional automatic warehouse equipment and 3-dimensional parking equipment, etc.
Construction machines related	Base foundation machine, shredder, mill, and tunnel drilling machine, etc.
Textile machine	Chemical fiber machine, <u>spinning machine</u> , <u>loom</u> and dyeing finish machine, etc.
Food processing machine	Rice/wheat cleaning machine, flour milling machine, noodle making machine, and tea manufacturing machine, etc.
Packing machine	Inner packing machine, outer packing machine and packing machine, etc.
Wood processing machine	Woodwork machine, sawing lumbering machine and woodwork milling machine, etc.
Metal handicraft machine	Lathe, drilling machine, milling machine and grinding machine, etc.
Metal processing machine	<u>Wire drawing machine</u> , press machine and <u>winding/rewinding machine</u> , etc.
Paper making and printing machine	<u>Printing machine</u> , <u>make-up machine</u> and <u>paperwork machine</u> , etc.
Automatic service devices	Health care tool (Room runner and so on), Medical appliance (X-ray equipment) <u>stage setting</u> , and <u>playing machine</u> , etc.
Environment and life-related machine	Business-purpose washing machine, car-wash machine, kitchen garbage processing machine, dust chamber and home elevator, etc.

Compared with the speed control, the torque control gives the inverter a command of a torque to be applied to a load machine and the inverter controls, in accordance with the torque command, the speed in the inverter to automatically change so that the speed can match with the load torque.

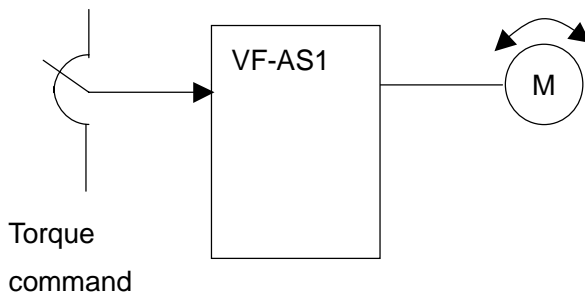

Main application	
Group	Examples
Textile machine	Chemical fiber machine, <u>spinning machine</u> and <u>loom</u> , etc.
Metal processing machine	<u>Winding/rewinding machine</u> , etc.
Paper making and printing machine	<u>Printing machine</u> , <u>make-up machine</u> and <u>paperwork machine</u> , etc.
Automatic service devices	<u>Stage setting</u> , and <u>playing machine</u> , etc.

3. Torque control setting

To operate the VF-AS1 under the torque control, set parameters following the procedure below:

■ Related parameters

Pt: V/f control mode selection

F111 to **F118**: Input terminal function selection 1 to 8 (use one of them)

F420: Torque command selection

• **Function**

It is set and used for the torque control through external operation (terminal input) or communication. At the same time, the setting allows switching between the speed control and torque control during operation.

1) V/f control mode selection

Set following parameters when torque control is performed;

Without motor speed sensor: $Pt = 4$

With motor speed sensor: $Pt = 8$

Title	Function	Adjustment range	Default setting
Pt	V/f control mode selection	0: Constant torque characteristics 1: Square reduction torque control characteristics 2: Automatic torque boost 3: Sensorless vector control 1 4: Sensorless vector control 2 5: V/f 5-point setting 6: PM control 7: PG feedback vector control 1 8: PG feedback vector control 2	0

* The control method to perform the torque control (vector control) requires the setting of a motor-related constant.

(Refer to Section 6. 22 in the instruction manual (E65801301) attached to the inverter.)

2) Torque control selection

Torque control selection methods include:

- Method with a terminal signal
- Method with parameter setting
- Method with communication

■ Torque control selection by means of terminal signals

The method assigns the torque control switching signal to any of input terminals in the inverter and selects torque control/speed control by switching ON/OFF of the signal.

In the standard setting at factory shipping, a function of preset speed command 3 is assigned to the S3 terminal. To use it for a terminal for control switching, it is required to change the terminal assignment.

Title	Function	Adjustment range	Default setting
<i>F 117</i>	Input terminal function selection 7 (S3)	0 to 135	112

Note 1: If the S3 terminal is already used, assign the function to an unused terminal.

Note 2: It is possible to reverse the logics of ON/OFF. In this case, the setting value is 113.

Note 3: It also is possible that the setting always is for the torque setting.

(*F 110* or *F 127* or *F 128*: assigned to Always ON function selection)

■ Control switching

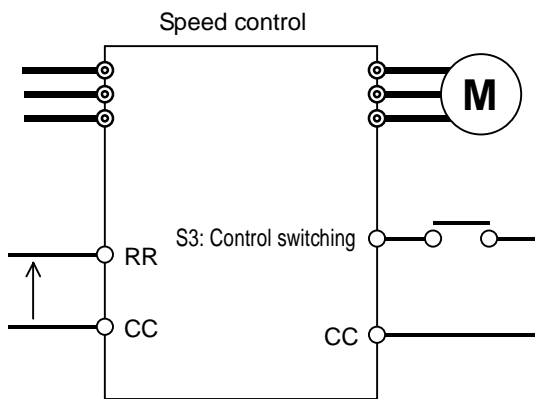

Control switching	OFF between S3-CC
Speed command	RR-CC (default setting)

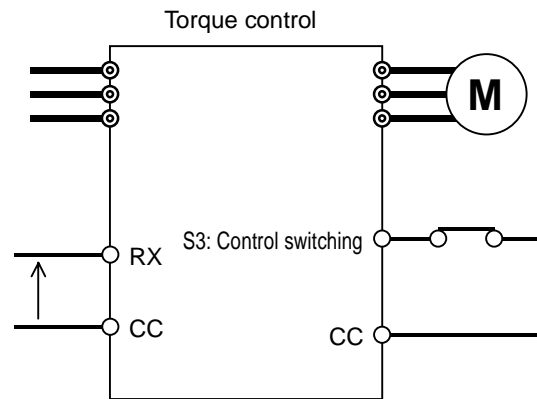

Control switching	ON between S3-CC
Torque command	RX-CC (default setting)

3) Torque command

■ Related parameters

F420: Torque command selection

F435: Prohibition of rotation in any direction other than the specified one (F or R)

F201: VI/II input point 1 setting

F205: VI/II input point 1 rate

F203: VI/II input point 2 setting

F206: VI/II input point 2 rate

F210: RR/S4 input point 1 setting

F214: RR/S4 input point 1 rate

F212: RR/S4 input point 2 setting

F215: RR/S4 input point 2 rate

F216: RX input point 1 setting

F220: RX input point 1 rate

F218: RX input point 2 setting

F221: RX input point 2 rate

F222: AI1 input point 1 setting

F226: AI1 input point 1 rate

F224: AI1 input point 2 setting

F227: AI1 input point 2 rate

F725: Operation panel torque command

F727: Operation panel tension torque bias

F728: Operation panel load sharing gain

• **Function**

Selecting a mode of torque command in torque control mode.

The command set with **F420** is enabled. (Default setting: RX input)

Title	Function	Adjustment range	Default setting
F420	Torque command selection	1:VI/II (voltage/current input) 2:RR/S4 (Potentiometer/voltage input) 3:RX (voltage input) 4:Operation panel input enabled 5:Communication panel RS485 input 6:Communication internal RS485 input enabled 7:Communications option input 8:AI1 (differential current input)	3

Note 1: Selecting 4 (panel input) activates the control panel torque reference **F725**.

Note 2: Use two-phase input type sensor when torque control is operated by vector control with a sensor.

Note 3: For sensorless vector control, "forward power running ⇔ reverse regeneration," and "forward regeneration ⇔ reverse power running" cannot be operated. Use vector control with a sensor (two-phase) for these uses.

1) Current signal 4 to 20mA

⇒ VI/II input *F 108* (analog input VI/II current/voltage switching) = *I* (current input)

[Default setting]

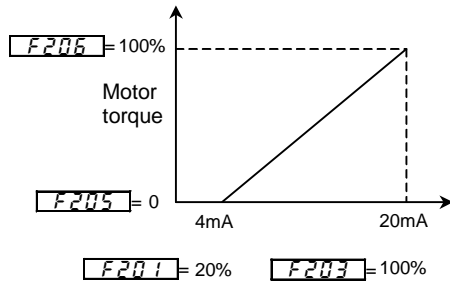

- Torque produced: 0% at 4mA and 100% at 20mA.

[Arbitrary setting]

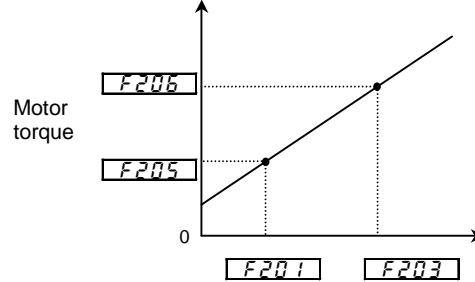

★The relationship between the torque command and the motor torque can be changed. *F201* and *F203* settings: 0 and 100% correspond to currents of 0 and 20mA, respectively.

2) Voltage signal 0 to 10Vdc ⇒ RR input

[Default setting]

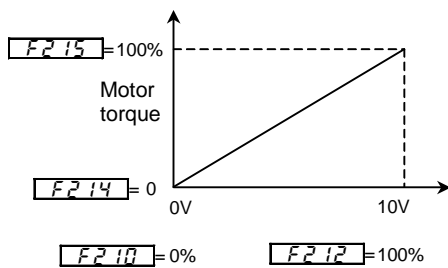

- Torque produced: 0% at 0Vdc and 100% at 10Vdc.

[Arbitrary setting]

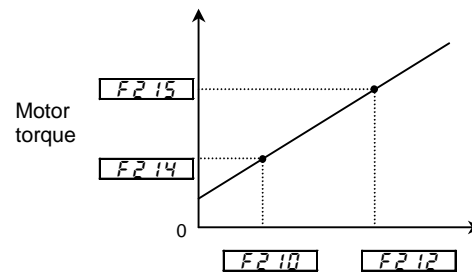

★The relationship between the torque command and the motor torque can be changed. *F210* and *F212* settings: 0 and 100% correspond to voltages of 0 and 10Vdc, respectively.

3) Voltage signal 0 to ±10Vdc ⇒ RX input

[Default setting]

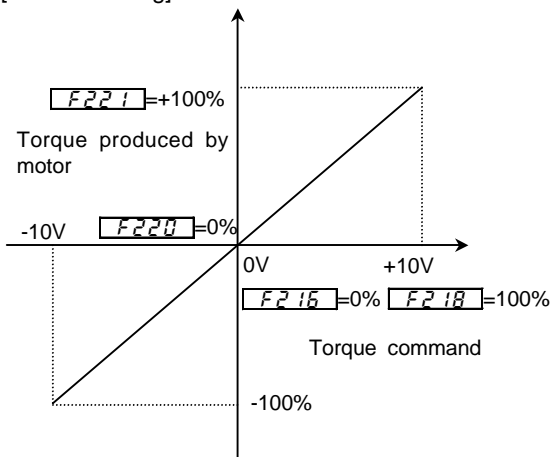

- Torque produced: -100% at -10Vdc, 0% at 0Vdc and +100% at 10Vdc.

[Arbitrary setting]

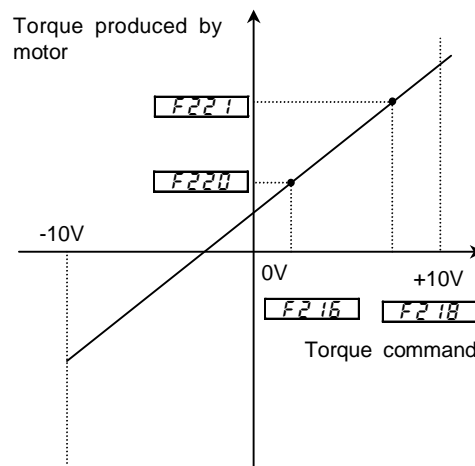

★The relationship between the torque command and the motor torque can be changed. *F216* and *F218* settings: 0 and ±100% correspond to voltages of 0 and ±10Vdc, respectively.

4. Concepts regarding torque control

4.1 Applied to application where the direction of rotation does not change

Polarities of torque command and torque limit

If the direction of rotation does not change continuously because of the machine characteristics, the torque control is used with $F435$ (Prohibition of rotation in any direction other than the specified one (F or R)) = 1 (enabled). The direction of rotation of the motor is set by a command: F (forward run signal) or R (reverse run signal).

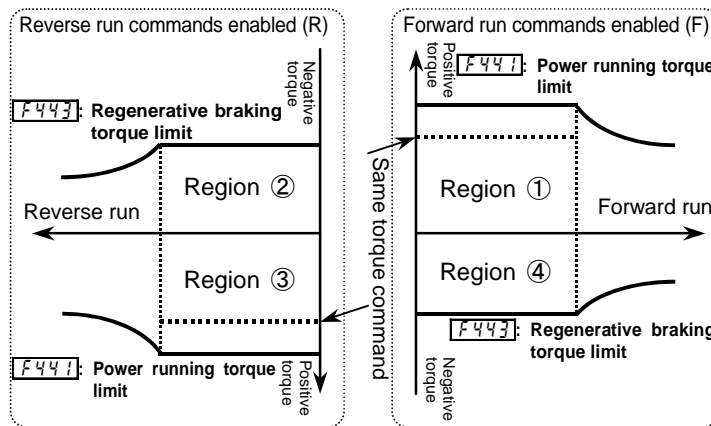

In paper manufacturing lines and so on, once machines have been set up, the directions of rotation of their motors are fixed and not be changed in succession, and when controlling the operation of the entire system, the torque produced in the desired direction of rotation (direction specified by a rotation command) is assumed to be positive torque and the torque produced in the direction opposite to that specified by the rotation command is assumed to be negative torque. For example, as shown in the next figures (inverter 1 and 2), the directions of rotation of the motors that drive rolls arranged in a line and rotate to send materials in one direction along the manufacturing line differ according to whether they are placed on this side or other side of the rolls that they drive. In this example, a selection between F (forward) and R (reverse) commands is made for each inverter according to the circumstances under which the system is operated. (Inverter 1: forward run, inverter 2: reverse run) However, torque commands from the host control unit of the system to the inverters have unified polarity and the direction of rotation of each individual motor is ignored. For this reason, this setting is usually used for systems that use motors whose directions of rotation depend on the circumstances under which the system is operated and are not be changed in succession. To prevent a motor from rotating in the direction opposite to that specified by a command under normal conditions, this setting is used with parameter $F435$ (prohibition of rotation in opposite direction (F or R)) set to 1. It can also be used for fixing the side from which a rewinder sends out the material: upper or lower side.

[Hint]

In the system shown below in which the product is sent in a fixed direction, the direction of rotation of each motor is determined by the command (F or R) from the inverter, regardless of the operating status: power running or regenerative braking.

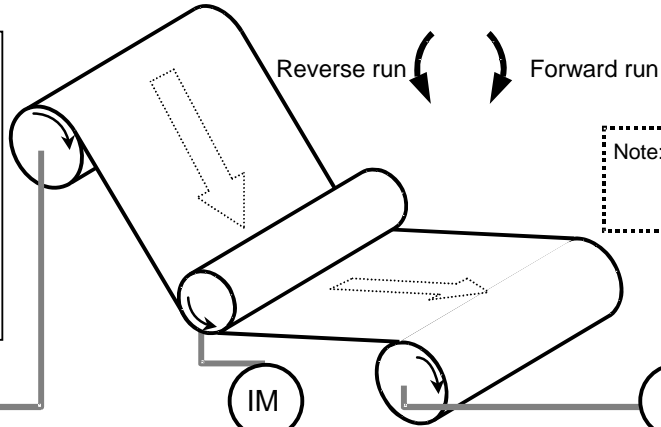

Note: In actual systems, torque control is not necessarily performed on all rolls.

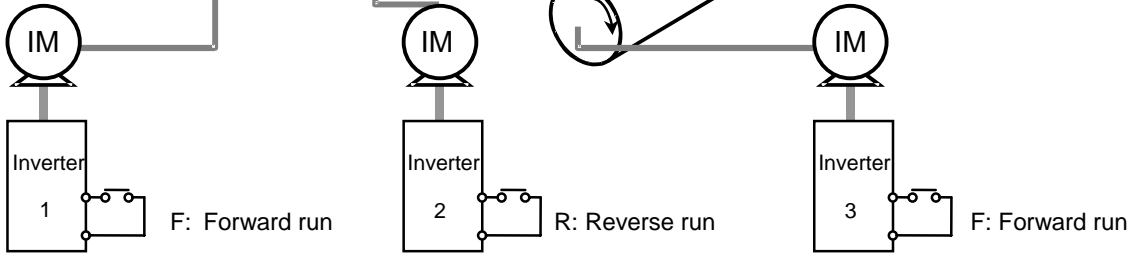

When torque control is performed by inverter 1

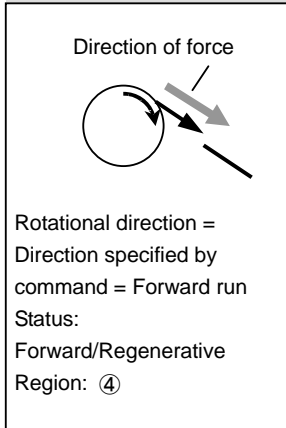

When torque control is performed by inverter 2

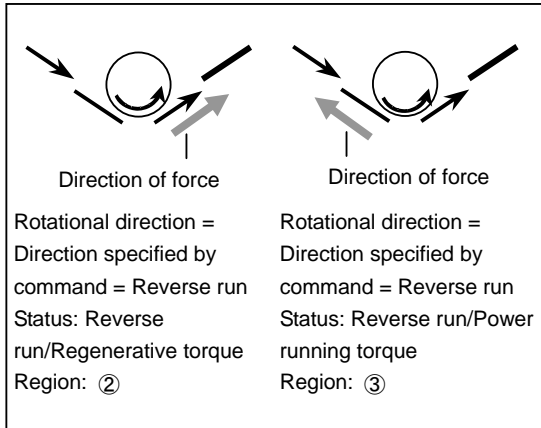

When torque control is performed by inverter 3

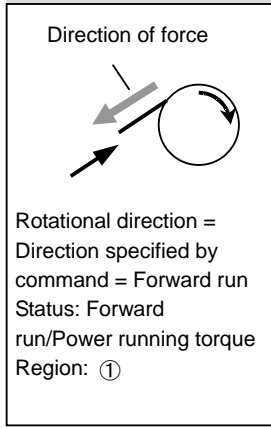

4.2 Applied to application where the direction of rotation changes

■ Polarities of torque command and torque limit

If the direction of rotation of the motor changes continuously while the direction in which a force is applied does not change, the torque control is used with $F435$ (Prohibition of rotation in any direction other than the specified one (F or R)) = 0 (disabled).

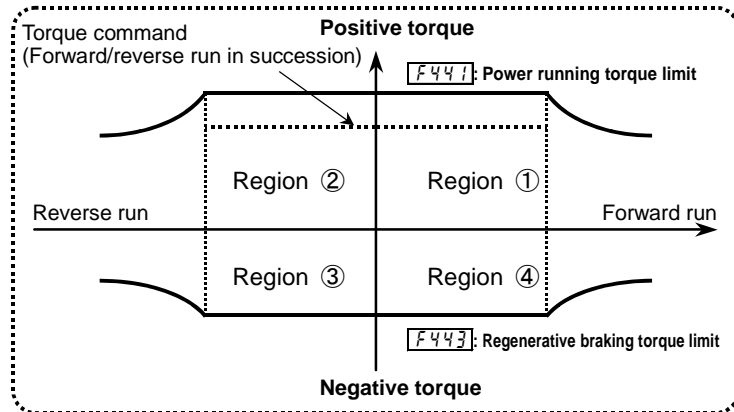

This setting is used for controlling a motor whose direction of rotation (polarity of torque, that is, power running or regenerative braking) is determined regardless of the command (F or R command) from the inverter.

[Hint]
In the system shown in the figures below, the direction of rotation of the motor, in other words, its operating status (power running or regenerative braking) may change in succession according to the circumstances.

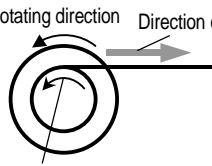
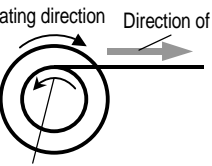
Torque command > Load torque	Torque command < Load torque
 <p>Inverter direction specified by command</p>	 <p>Inverter direction specified by command</p>
<p>Rotational direction = Forward run Inverter direction specified by command = Forward run Status: Forward run/Positive torque (power running) Region: ①</p>	<p>Rotational direction = Reverse run Inverter direction specified by command = Forward run Status: Reverse run/Positive torque (regenerative) Region: ②</p>

5. Speed limits in torque control mode

F425 : Forward speed limit input selection	F430 : Speed limit (torque=0) center value reference selection
F426 : Forward speed limit input level	F431 : Speed limit (torque=0) center value
F427 : Reverse speed limit input selection	F432 : Speed limit (torque=0) band
F428 : Reverse speed limit input level	F433 : Speed limit (torque=0) recovery time

• **Function**
 The function is to limit the rise in the output frequency of the inverter due to a drop of the load torque during operation in torque control mode. These functions are useful for protecting a machine.

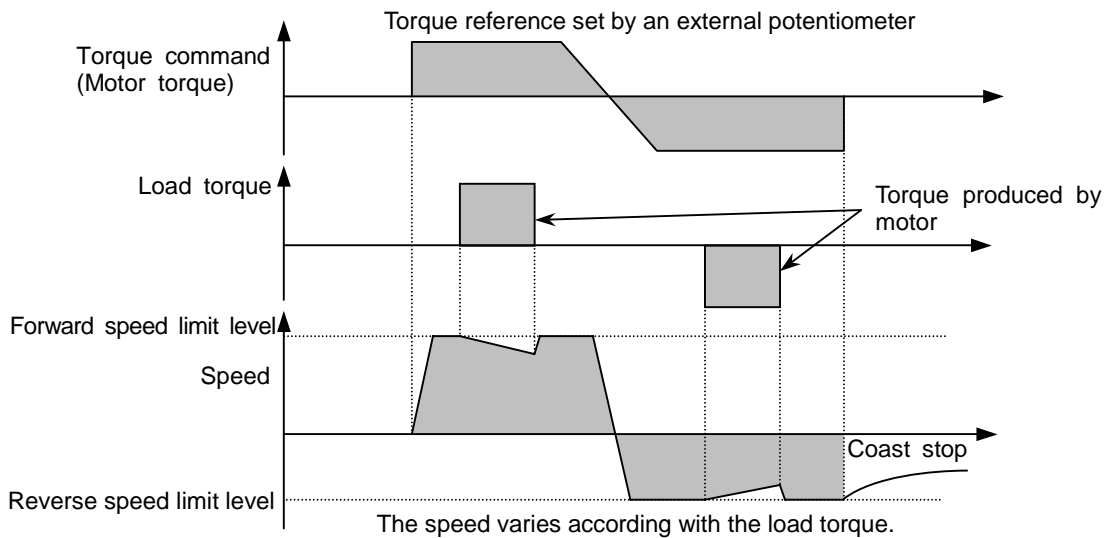

■ **Setting with the operation panel**

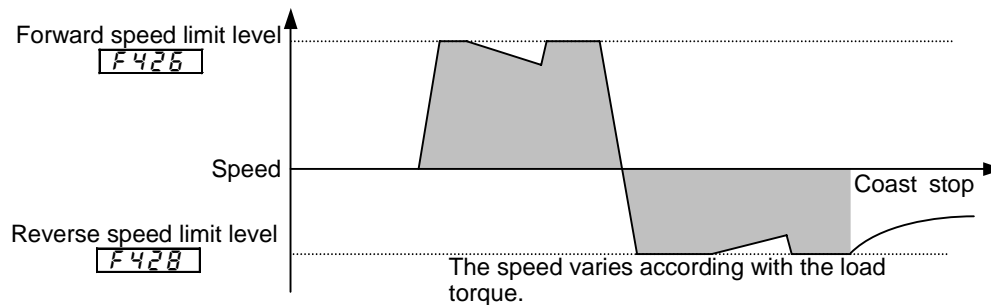

[Setting of forward speed limit level]

F425 (Forward speed limit input selection): **Set to 4 (value of *F426*)**

F426 (Forward speed limit input level): **Set a desirable forward speed limit level.**

[Setting of reverse speed limit level]

F427 (Reverse speed limit input selection): **Set to 4 (value of *F428*)**

F428 (Reverse speed limit input level): **Set a desirable reverse speed limit level.**

■ Setting by means of external signals

The speed limits can be changed arbitrarily by setting external signals.

[Selection of external signals]

		<i>F425</i> and <i>F427</i> settings	
Voltage signals	RR/S4-CC	: 0 to 10V	2
	RX-CC	: 0 to ±10V	3
	VI/II-CC	: 0 to 10V	1
Current signals	VI/II-CC	: 4(0) to 20mA	1

Title	Function	Adjustment range	Default setting
<i>F425</i>	Forward speed limit input selection	0 : Disabled 1 : VI/II (voltage/current input) 2 : RR/S4 (potentiometer/voltage input) 3 : RX (voltage input) 4 : <i>F426</i> enabled	0
<i>F426</i>	Forward speed limit input level	0.0 to UL	60.0
<i>F427</i>	Reverse speed limit input selection	0 : Disabled 1 : VI/II (voltage/current input) 2 : RR/S4 (potentiometer/voltage input) 3 : RX (voltage input) 4 : <i>F428</i> enabled	0
<i>F428</i>	Reverse speed limit input level	0.0 to UL	60.0

[Speed limit with the center value specified by a reference]

Title	Function	Adjustment range	Default setting
<i>F430</i>	Speed limit (torque = 0) center value reference selection	0 : Disabled 1 : VI/II (voltage/current input) 2 : RR/S4 (potentiometer/voltage input) 3 : RX (voltage input) 4 : <i>F431</i> enabled	0
<i>F431</i>	Speed limit (torque = 0) center value	0 to FH	0.0
<i>F432</i>	Speed limit (torque = 0) band	0 to FH	0.0
<i>F433</i>	Speed limit (torque = 0) recovery time	0.00 to 2.50	0.20

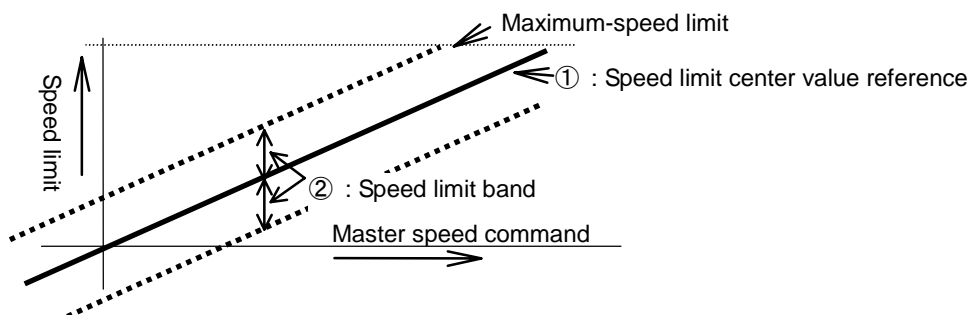

6. Setting motor constants

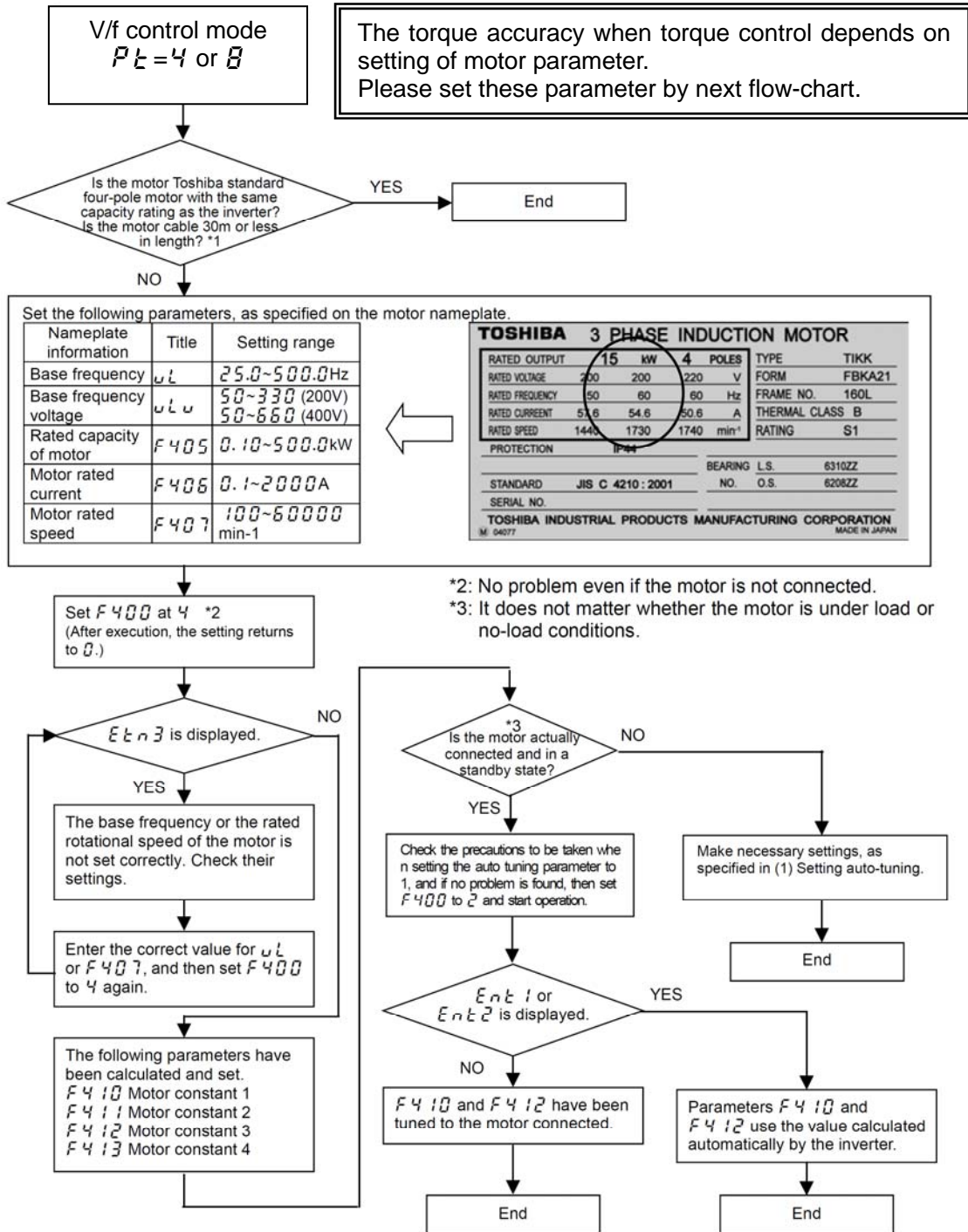

*1:

Motor used			Tuning required or not (Yes in flowchart: Tuning required, No: Tuning not required)
Type	No. of motor poles	Capacity	
Toshiba standard motor	4P	Same as the inverter capacity	* Not required (tuned to factory defaults)
		Different from the inverter capacity	Required
	Other than 4P	Same as the inverter capacity	
		Different from the inverter capacity	
Others			

* When using a long cable (guide: 30m or over), be sure to make auto-tuning 1 (F400=2).