

## TOSVERT VF シリーズ





## 制御電源バックアップオプション（CPS002Z）取扱説明書

## 1. 安全上のご注意





インバータ本体および取扱説明書には、お使いになる方や他の人への危害と財産の損害を未然に防ぎ、安全に正しくお使いいただくために、重要な内容を記載しています。

インバータ本体付属の取扱説明書の安全上の注意等を理解のうえ、本文をお読みに  
なり、記載事項をお守りください。



## ■ 取扱全般について

 警告	
 分解禁止	<ul style="list-style-type: none"> <li>▼ 分解・改造・修理しないこと。 感電・火災・けがの原因となります。修理は販売店にご依頼ください。</li> </ul>
 禁止	<ul style="list-style-type: none"> <li>▼ 内部に物（電線くず、棒、針金など）を入れたり、差し込まないこと。 感電・火災の原因となります。</li> <li>▼ 水などの液体をかけないこと。感電・火災の原因となります。</li> </ul>
 強制	<ul style="list-style-type: none"> <li>▼ インバータ本体の電源を切ってから配線を行うこと。</li> <li>▼ もし、煙が出ている、変なにおいがする、異常音がするなどの異常が発生した場合は、すぐに入力電源を遮断（OFF、切）すること。そのまま使用すると、火災の原因となります。販売店に修理をご依頼ください。</li> </ul>



## ■ 運搬・据付について

 警告	
 禁止	<ul style="list-style-type: none"> <li>▼ 損傷したり、部品が欠けている場合は、据え付け運転しないこと。 感電・火災の原因となります。販売店に修理をご依頼ください。</li> <li>▼ 可燃物を近くに置かないこと。もし、故障などで発火した場合に、火災の原因となります。</li> <li>▼ 水などの液体のかかる所に取付けないこと。感電・火災の原因となります。</li> </ul>
 強制	<ul style="list-style-type: none"> <li>▼ 取扱説明書に定められた環境条件で使用すること。 それ以外の条件で使用すると故障の原因となります。</li> </ul>
 注意	
 禁止	<ul style="list-style-type: none"> <li>▼ 振動の大きいところに取付けないこと。 本体が落下し、けがの原因となります。</li> </ul>



## ■ 配線について

 <b>警告</b>	
 強制	<p>▼ 配線する前に次の作業をすること。</p> <p>① 入力電源を遮断（OFF、切）する。</p> <p>② 15分以上経過してからチャージランプ（インバータ本体及びオプションユニット内）が消灯していることを確認する。</p> <p>③ 直流高電圧（DC800V以上）が測定可能なテスタ等を使用して直流主回路電圧（PA-PC間）が45V以下であることを確認する。 これらの作業をせずに配線すると、感電の原因となります。</p> <p>▼ 端子台ネジは指定の締め付けトルクで締めること。 指定の締め付けトルクで締めないと、火災の原因となります。</p>

## ■ 運転操作について

 <b>警告</b>	
 禁止	<p>▼ モータが停止していてもインバータに通電している時はインバータ本体及びオプションユニットの端子に触れないこと。通電中にインバータ端子に触れると感電の原因となります。</p> <p>▼ ぬれた手でスイッチを操作したり、ぬれた布などでふかないこと。感電の原因となります。</p> <p>▼ ケーブルを引っ張らないこと。破損、誤動作の原因となります。</p>

## ■ 廃棄について

 <b>注意</b>	
 強制	<p>▼ 本製品を破棄する場合は、専門の廃棄物処理業者(*)に依頼すること。産業廃棄物の収集・運搬及び処分は認可を受けていない者が行くと、法律により罰せられます。（「廃棄物の処理ならびに清掃に関する法律」） (*)専門の廃棄物処理業者とは、「産業廃棄物収集運搬業者」、「産業廃棄物処分業者」をいいます。</p>

## 2. 機器の名称と機能、寸法

### ■ 外観および端子台配列

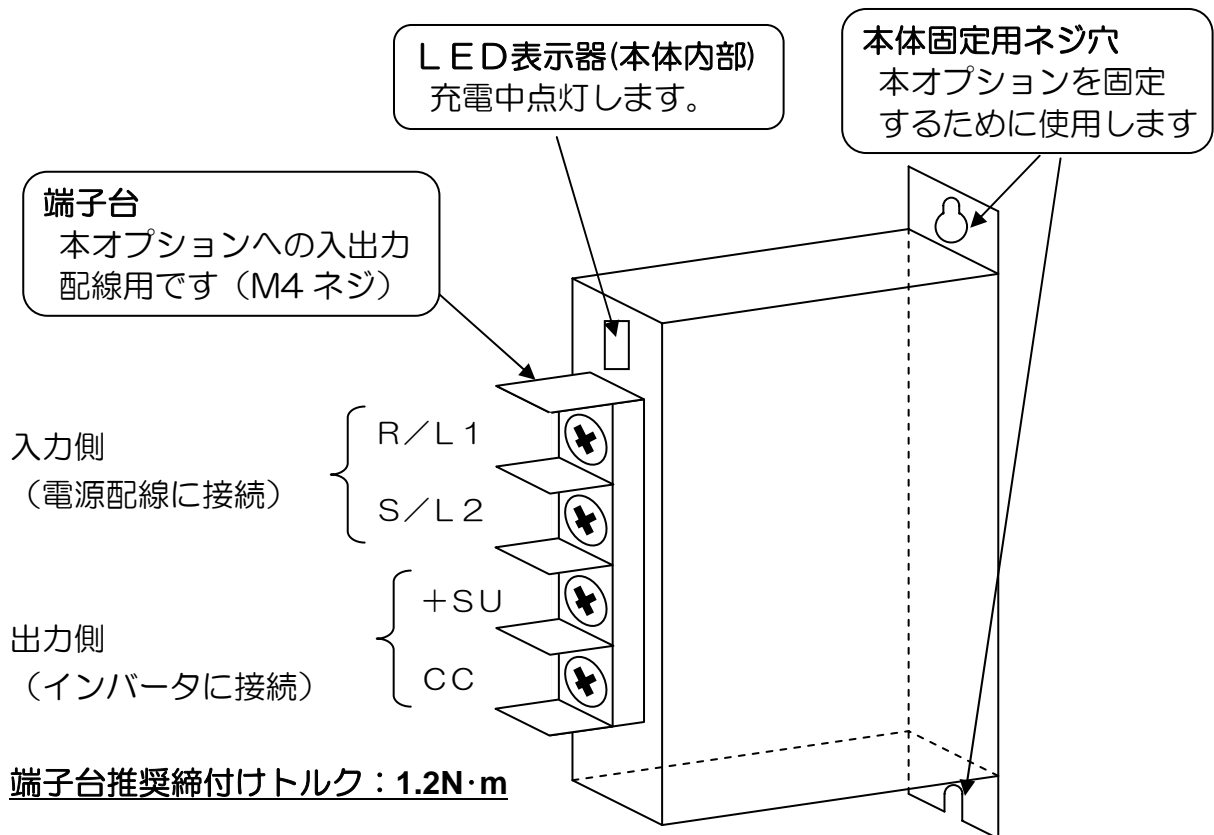

### ■ 外形図

(単位：mm)

取り付けの際に配線スペースを忘れないよう注意してください。取り付けにはM4ネジを使用して下さい。

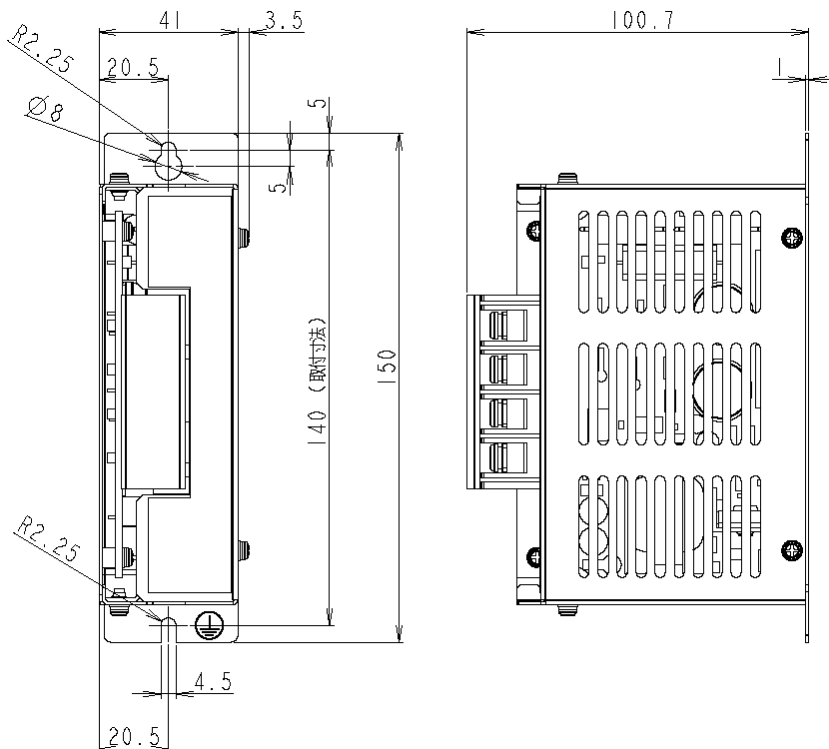

### 3. 接続

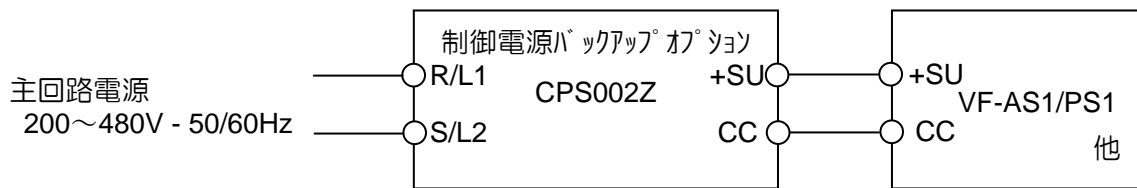

推奨電線サイズ R/L1, S/L2 : 2mm<sup>2</sup>  
+SU, CC : 0.75 mm<sup>2</sup>

### 4. 機器の仕様

項目	仕様
形式	CPS002Z
電源電圧	AC200~480V - 50/60Hz (200Vクラス/400Vクラスのどちらにも使用可能)
許容変動	電圧 -15%/+10%、周波数±5%
出力電圧	DC24V ±10%
出力電流	1.05A
使用環境	屋内、標高 1000m 以下、直射日光や腐食性および爆発性ガス、蒸気、粉塵、塵埃、研削液、研削油のないこと
周囲温度	-10~+60℃
保存温度	-25~+70℃
相対湿度	5~95% (結露ないこと)
振動	5.9m/s <sup>2</sup> (0.6G) 以下 (10~55Hz) (JIS C0040 準拠)
冷却方式	自冷
概略質量	0.4kg

注1) 本ユニット1台につき1台のインバータの制御電源を駆動できます。

注2) 本ユニットが故障した場合に、アラーム出力またはトリップ出力させることが可能です。詳細は、本体付属の取扱説明書をご参照願います。

### 5. 保証

下記の内容により、無償で修理を行います。

1. 正常な据え付けおよび取扱いのもとで納入後1年以内に故障が発生し、その原因が明らかに弊社の設計、製作上の責任に帰するときは、無償で修理いたします。
2. 保証の範囲は納品本体のみといたします。
3. 保証期間内についても次のような場合は有償となります。
  - a) ご使用の誤り、および、不当な修理や改造による故障および損傷。
  - b) お買い上げ後の落下、および、運送上の故障および損傷。
  - c) 火災、塩害、ガス害、地震、風水害、落雷、電圧異常およびその他の天災地変を原因とする故障および損傷
  - d) 制御電源オプションユニットとしての機能、用途以外に使用された場合の損傷。
4. 本保証は、日本国内のみで有効です。
5. 別に定める保証条件がある場合、そちらが優先します。





# TOSVERT VF SERIES

## Optional Control Power Supply Backup (CPS002Z) Instruction Manual





### 1. Safety precautions

On the inverter and in its instruction manual, important information is described to prevent injury to you and other people around you as well as to prevent damage to property in the area and is intended for proper use of the device. Read the instruction manual attached to the inverter along with this instruction manual to thoroughly understand the safety precautions and observe the items described in these manuals.



■ Handling in general

 <b>Warning</b>	
 Never Disassemble	- Never disassemble, modify or repair this unit. This can result in electric shock, fire or injury. For repairs, contact TOSHIBA group representative.
 Prohibited	- Do not place or insert any kind of object into this unit (electrical wire cuttings, rods, wires and so on). This can result in electric shock or fire. - Do not splash water over this unit. This can result in electric shock or fire.
 Mandatory	- Wiring should be conducted after turning off the inverter power. - Turn off the power immediately in case any abnormality such as smoke, smell or unusual sounds is found. If the inverter is continued in operation in such a state, result can be fire. Contact TOSHIBA group representative for repairs.



■ Transportation and Installation

 <b>Warning</b>	
 Prohibited	- Do not install or operate the inverter if it is damaged or any part is missing. Operating the inverter in a defective condition can result in electric shock or fire. Contact TOSHIBA group representative for repairs. - Do not place any inflammable material near the inverter. If a flame is emitted due to malfunction, it can result in a fire. - Do not install in any location where the inverter could come into contact with water or other fluids. This can result in electric shock or fire.
 Mandatory	- Inverter must be used under the environmental conditions prescribed in this instruction manual. Using the inverter under any other conditions can result in malfunction.
 <b>Caution</b>	
 Prohibited	- Do not install the inverter in a place subject to large amounts of vibration. That could result in the unit falling, resulting in injury.



## ■ Wiring

 <b>Warning</b>	
 Mandatory	<ul style="list-style-type: none"> <li>- Be sure to perform the following preparatory work before proceeding to wiring.             <ol style="list-style-type: none"> <li>1) Turn off all input power to the inverter.</li> <li>2) Wait for at least 15 minutes and check to make sure that the charge lamp (on the inverter and in the option unit) is no longer lit.</li> <li>3) Use a circuit tester that can measure DC voltages (800VDC or more), and check to make sure that the voltage to the DC main circuits (across PA-PC) is 45V or less.</li> </ol> </li> <li>Failure to do this preparation could lead to electric shock.</li> <li>- Tighten the terminal screws to the specified torque.</li> <li>Failure to do this could lead to fire.</li> </ul>

## ■ Operations

 <b>Warning</b>	
 Prohibited	<ul style="list-style-type: none"> <li>- Do not touch inverter terminals when they are energized even if the motor is stopped. Touching the terminals while the power is energized can result in electric shock.</li> <li>- Do not operate switches with a wet hand nor try to clean the inverter with a damp cloth. This can result in electric shock.</li> <li>- Do not pull on the cables. This can result in damage or erroneous operation.</li> </ul>

## ■ Disposal of Product

 <b>Caution</b>	
 Mandatory	<ul style="list-style-type: none"> <li>- When you throw away the inverter, have it done by a specialist in industrial waste disposal*.</li> <li>If the collection, transport or disposal of industrial waste is done by someone who is not licensed, it is punishable as a violation of the law. (Laws in regard to disposal and cleaning of waste.)</li> <li>(*People who specialize in the processing of waste and are known as "industrial waste collectors and transporters" or "industrial waste disposal specialists".</li> </ul>

## 2. Names and functions

### External view and terminal layout

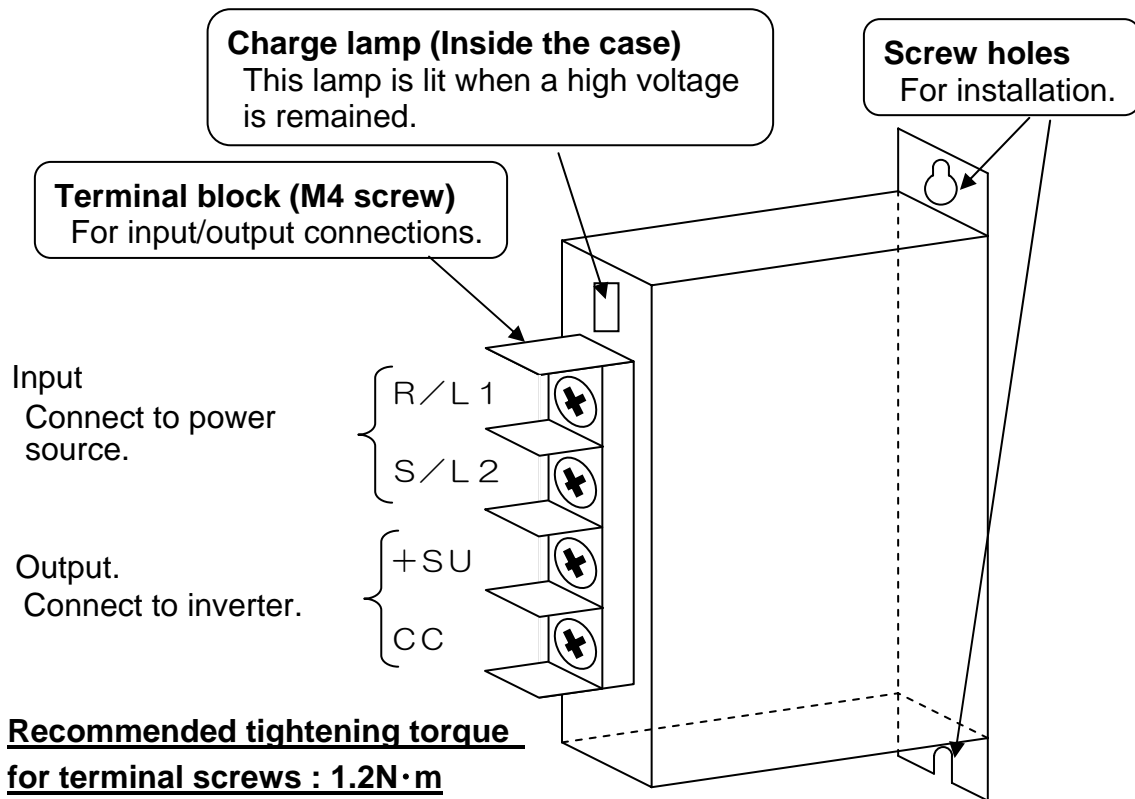

### Dimensions

(UNIT : mm)

Wiring space must be considered in installation. Adopt M4 screws for fixing.

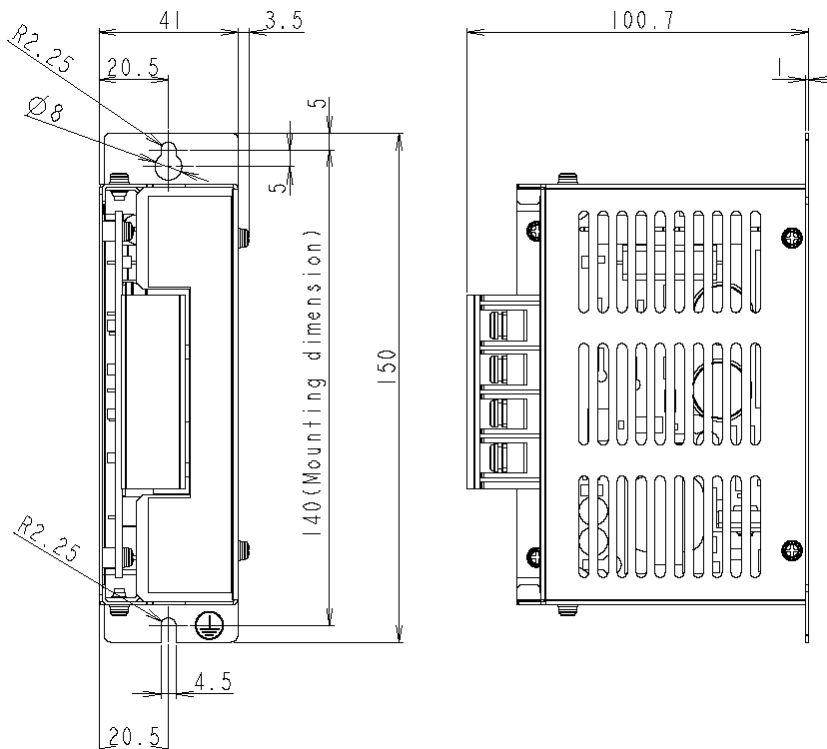

### 3. Specifications

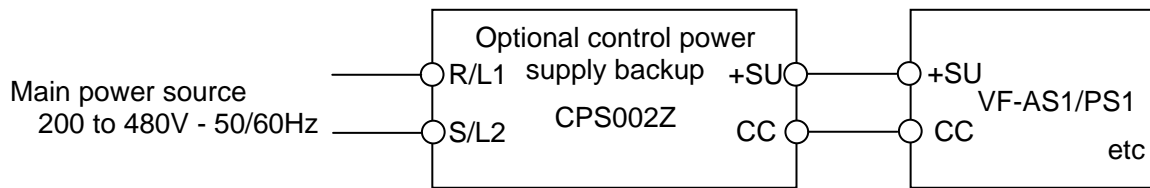

Recommended wire size R/L1, S/L2 : 2mm<sup>2</sup>  
+SU, CC : 0.75mm<sup>2</sup>

### 4. Specifications

Item	Specification
Type	CPS002Z
Power supply voltage	AC200 - 480V, 50/60Hz (This option unit can be used for both 200V class and 400V class inverter.)
Allowable fluctuation	Voltage -15%, +10%, frequency $\pm 5\%$
Output voltage	DC24V $\pm 10\%$
Output current	1.05A
Operating environment	Indoors, altitude 1000m or less, not exposed to direct sunlight, corrosive gas, explosive gas, steam, powder, dust, grinding fluid, or grinding oil
Ambient temperature	-10 to +60 deg.C
Storage temperature	-25 to +70 deg.C
Relative humidity	5 to 95% (No condensation)
Vibration	5.9m/s <sup>2</sup> (0.6G) or less (10 to 55Hz)
Cooling method	Self cooling
Approx. mass	0.4kg

Note1) CPS002Z is designed to drive control power of one inverter per unit.

Note2) When CPS002Z malfunctions, alarm output or trip output is possible.

Please refer to the attached instruction manual for details.

### 5. Warranty

The unit will be repaired free of charge under the following conditions:

1. A failure of the unit occurs after it is installed correctly and under normal use within one year from the date of delivery and the cause of the failure is apparently attributable to the Toshiba Schneider Inverter Corporation's design and manufacturing processes.
2. The scope of warranty is limited to the delivered unit itself.
3. For the following kinds of failure or damage, the repair cost shall be borne by the customer even within the warranty period.
  - 1) Failure or damage caused by incorrect use or unauthorized repair or modification of the unit.
  - 2) Failure or damage caused by the unit falling or an accident during transportation after the purchase.
  - 3) Failure or damage caused by fire, salty water or wind, corrosive gas, earthquake, storm or flood, lightning, abnormal voltage supply, or other natural disasters.
  - 4) Failure or damage caused by the use of the function (application) other than the intended one.
4. If any other separate prescribed warranty condition exists, that one has priority over this one.