TOSVERT VF-AS1/PS1 series

EtherNet/IP™ option unit Instruction Manual

IPE001Z

NOTICE

1. Make sure that this instruction manual is delivered to the end user of EtherNet/IP™ option unit.
2. Read this manual before installing or operating the EtherNet/IP™ option unit. Keep it in a safe place for reference.
3. All information contained in this manual are subject to change without notice. Please confirm the latest information on our web site “www.inverter.co.jp”.





E6581580REV02

Safety precautions

On the inverter and in its instruction manual, important information is contained for preventing injuries to users, damages to assets, and for proper use of the device.

Read the instruction manual attached to the inverter along with this instruction manual to completely understand the safety precautions, the symbols and indications shown below. Please adhere to the contents of these manuals at all times.



Explanation of markings

Marking	Meaning of marking
 Warning	Indicates that errors in operation may lead to death or serious injury.
 Caution	Indicates that errors in operation may lead to injury (*1) to people or that these errors may cause damage to physical property. (*2)

(*1) Such things as injury, burns or shock that will not require hospitalization or long periods of outpatient treatment.

(*2) Physical property damage refers to wide-ranging damage to assets and materials.





Meanings of symbols

Marking	Meaning of marking
	Indicates prohibition (Do not do it). What is prohibited will be described in or near the symbol in either text or picture form.
	Indicates something mandatory (must be done). What is mandatory will be described in or near the symbol in either text or picture form.
	Indicates danger or warning. What is dangerous, or what the warning should be applied to will be described in or near the symbol in either text or picture form.



■ **Limitation of use**

⚠ Safety precaution	
▼ Never use this unit with any device other than TOSVERT VF-AS1/PS1 series inverters. Doing so may cause an accident.	



■ **Handling in general**

⚠ Warning	
 Never Disassemble	▼ Never disassemble, modify or repair the product. Disassembling the product may cause electric shocks, fire or injuries. For repairs, call your sales/repair agency.
 Prohibited	▼ Do not open the front cover on the inverter while the inverter power is on. It may lead to electric shocks. ▼ Do not remove this option from VF-AS1/PS1 while the power is on. It may lead to electric shocks. ▼ Do not put or insert foreign objects such as waste cable, bars or wires into the product. It may lead to electric shocks or fire. ▼ Do not splash water over the product, and do not wipe the body with a wet cloth. It may lead to electric shocks or fire.
 Mandatory	▼ Turn off the power immediately in case of any abnormalities such as smoke, smell or abnormal noise. Neglect of these conditions may lead to fire. For repairs, call your sales/repair agency. ▼ Do not touch the sharp portions (such as leads of parts on the board, the corner of board, or etc.) on this option. It may lead to injuries.
⚠ Caution	
 Mandatory	▼ This option is an electrostatic discharge sensitive device. Handle it, where the environment is protected against electrostatic electricity. Otherwise, permanent damage to device will result.





■ **Transportation and installation**

⚠ Warning	
 Prohibited	▼ Do not apply a dropping shock or other physical shocks. Otherwise, damage or malfunction will result. ▼ Do not install or operate the inverter if it is damaged or any part of it is missing. Operating a defective inverter may lead to electric shocks or fire. For repairs, call your sales/repair agency. ▼ Do not put any flammable material near the product. It may catch fire due to the product sparking in the case of a malfunction.
 Mandatory	▼ Use this product under the environmental conditions prescribed in the instruction manual. Usage it under any other conditions may result in malfunction. ▼ An emergency stop device must be installed that fits with system specifications (e.g. shut off input power then engage mechanical brake). Operation cannot be stopped immediately by the inverter or this unit alone, thus risking an accident or injuries.



■ **Wiring**

 Caution	
 Mandatory	<ul style="list-style-type: none"> ▼ Electrical construction work must be done by a qualified expert. Connection of input power by someone who does not have expert knowledge may result in electric shocks or fire. ▼ Turn off input power before wiring. Wait at least 15 minutes and make sure that the charge lamp (on the inverter unit) is no longer lit. Otherwise, it may lead to electric shocks.

■ **Operations**

 Warning	
 Prohibited	<ul style="list-style-type: none"> ▼ Do not pull on the cable and connector. It may cause damage or malfunctions.
 Mandatory	<ul style="list-style-type: none"> ▼ Use this option under the environment specified in the instruction manual. Usage under the environment other than them may cause damages or malfunctions or an accident. ▼ Use an additional safety device with your inverter or system to prevent a serious accident due to the unit malfunctions. Usage without an additional safety device may cause an accident.
 Caution	
 Mandatory	<ul style="list-style-type: none"> ▼ Set up “Communication error trip function (see below)” to stop the inverter when the option unit is deactivated by an unusual event such as an operating error, power outage, failure, etc. <ul style="list-style-type: none"> - Network time-out (<i>F850</i>) (See the VF-AS1/PS1 EtherNet/IP™ Communication Function Manual for details.) Deactivated option unit may cause an accident, if the “Communication error trip function” is not properly set up. ▼ Make sure that the operation signals are STOP before resetting inverter’s fault. The motor may suddenly start and that may result in injuries.

■ **Disposal**

 Caution	
 Mandatory	<ul style="list-style-type: none"> ▼ If you dispose off this unit, have it done by a specialist in industrial waste disposal*. Improper disposal may result in explosion of capacitors or produce noxious gases, resulting in injuries. (*) Persons who specialize in the processing of waste and known as “Industrial Waste Product Collectors and Transporters” or “Industrial Waste Disposal Persons.” If the collection, transport and disposal of industrial waste is done by someone who is not licensed for that job, it is a punishable violation of the law (Laws in regard to cleaning and processing of waste materials).

■ **Notes on operation**

Notes	
	<ul style="list-style-type: none"> ▼ Avoid installing in a place where ambient temperature or/and humidity change sharply. ▼ Keep the transmission cable separate from the power cable of the inverter to prevent the inverter from malfunctioning due to electromagnetic noise.

Preface

Thank you for purchasing the “EtherNet/IP™ option (IPE001Z)” for TOSVERT VF-AS1/PS1 inverter. By installing this board into the VF-AS1/PS1, data communication can be made with a host computer or other device via EtherNet/IP™ network.

Before using this unit, carefully read and understand the safety precautions, this manual and the inverter instruction manual. This way you can utilize the excellent performance of this unit. Besides this instruction manual, the “EtherNet/IP™ option Function Manual” which includes the contents to install into EtherNet/IP™ network is prepared. If it is required, please contact with our branch offices, sales offices or web site “www.inverter.co.jp”.

(“EtherNet/IP™ option Function Manual”: E6581581)

After reading this instruction manual, please keep it handy for future reference.

EtherNet/IP™ is a trademark of ControlNet International, Ltd.

*IPE001Z is applicable for VF-AS1 (software version V150 or later) and VF-PS1 (software version V650 or later).

- Part numbering

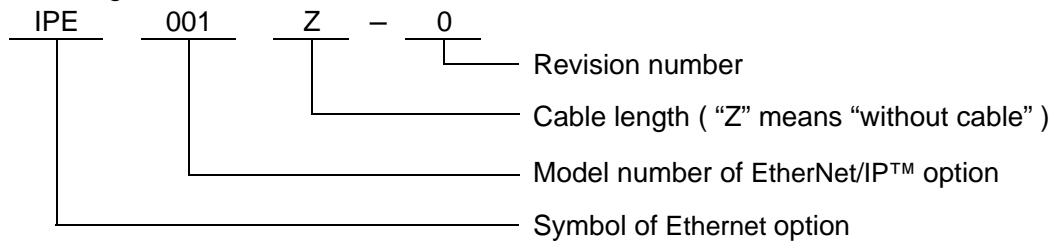

- Accessory check list

EtherNet/IP™ communication option is shipped together with the following accessories. On opening the packing case, check to see if the following accessories are contained or not.

- (1) EtherNet/IP™ option (IPE001Z)..... 1 board

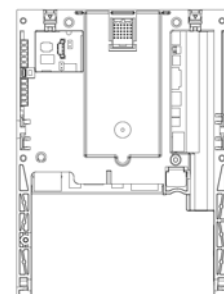

- (2) Instruction manual for the VF-AS1/PS1 EtherNet/IP™ option.....1 copy

(English: E6581580)
 ((This manual))

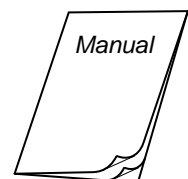

- (3) LED name label

1 sheet

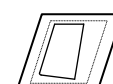

Table of Contents

1. Overview	6
2. Names and functions.....	6
2.1. Outline.....	6
2.2. RJ45 connector pin layout.....	7
2.3. Example of connection to an EtherNet/IP™	7
2.4. LED indicator.....	8
3. Installing the IPE001Z	9
4. Parameters.....	10
4.1. Communication parameters	10
4.2. <i>F85</i> !: Communication Loss Action Setting (Network Disconnection)	12
5. Command & Setpoint selection (Local/Remote).....	13
6. Specifications	15
7. Warranty.....	15

1. Overview

The EtherNet/IP™ interface (IPE001Z) allows the VF-AS1/PS1 inverter to be connected into the EtherNet/IP™ network.

2. Names and functions

The drawing below shows names and functions of main parts.

2.1. Outline

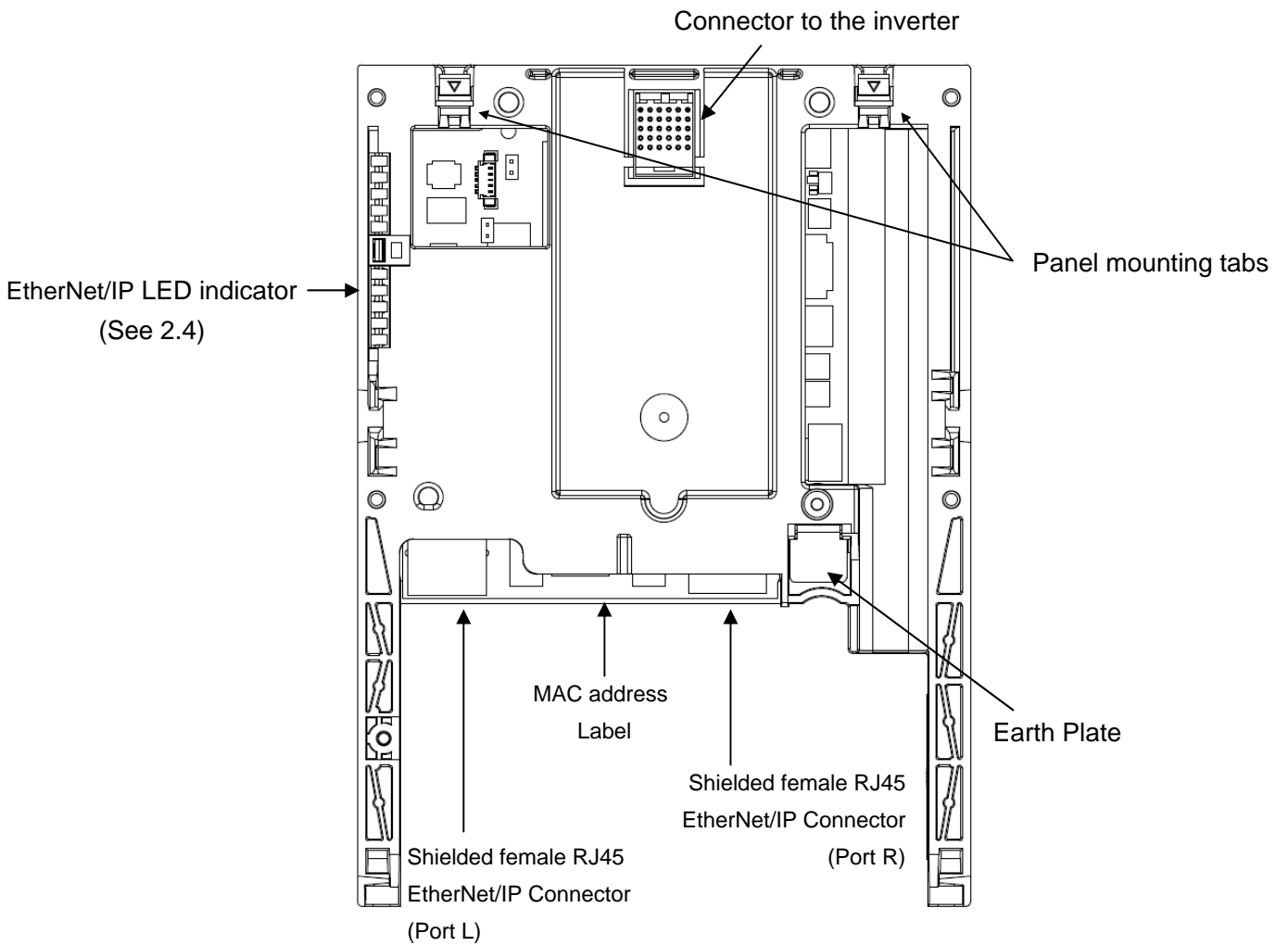

2.2. RJ45 connector pin layout

The EtherNet/IP™ card is equipped with two shielded RJ45 connectors. The shielding is connected to the drive ground.

Use an STP (shielded twisted pair) Ethernet cable

The transmission speed is detected automatically by the card (10 Mbps or 100 Mbps).

The card can operate in half duplex or full duplex mode, whether connected to a hub or a switch and regardless of the transmission speed (10 Mbps or 100 Mbps).

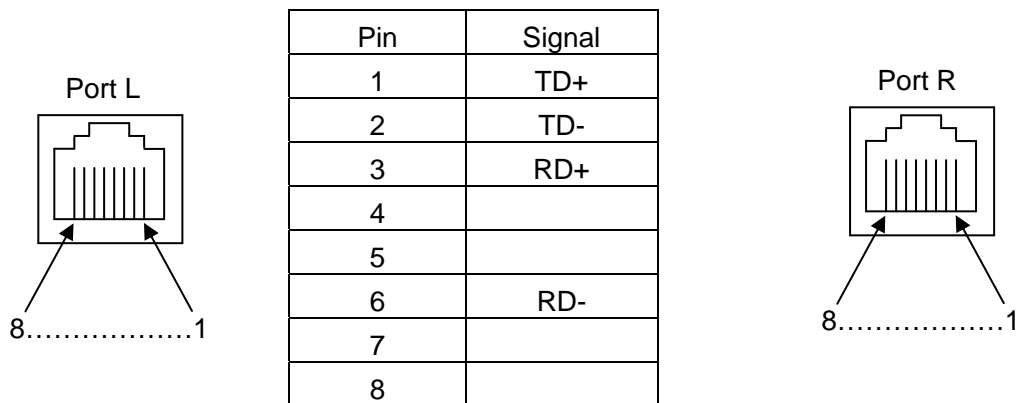

* Fix a cable so that a communication connector may be not taken the weight of wire.

2.3. Example of connection to an EtherNet/IP™

Daisy chain and/or star topology

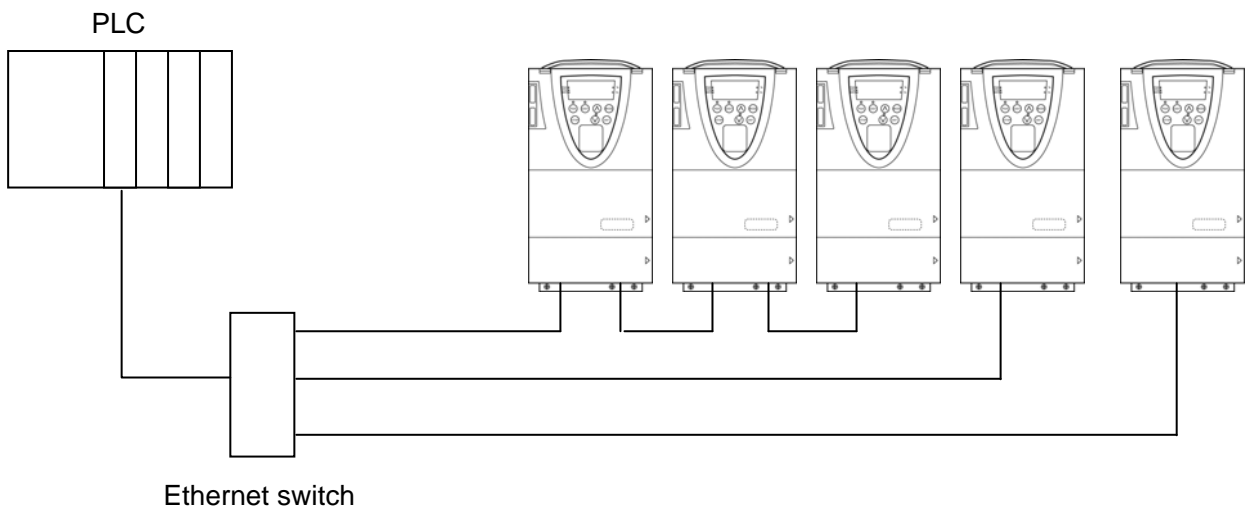

Notes	
	<ul style="list-style-type: none"> ▼ Provide strain relief so that the communication connector does not take the weight of the cable. ▼ Please connect this option to only the Modbus TCP communication line. This option does not work when connected to the other communication lines. For example, the RJ45 connector on the front of AS1/PS1 operation panel is for RS485 communication. Do not connect the Modbus TCP communication line to the RJ45 connector

2.4. LED indicator

The LED shows the present status of the network and error.

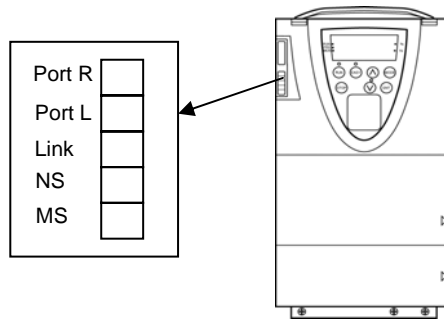

LED	Color/ state	Description
2.1 "Port R"	OFF	No Link
	Flashing Green/Yellow	Power Up testing
	Green ON	Link at 100 Mbps
	Yellow ON	Link at 10 Mbps
	Green BLINK	Activity at 100 Mbps
	Yellow BLINK	Activity at 10 Mbps
2.2 "Port L"	OFF	No Link
	Flashing Green/Yellow	Power Up testing
	Green ON	Link at 100 Mbps
	Yellow ON	Link at 10 Mbps
	Green BLINK	Activity at 100 Mbps
	Yellow BLINK	Activity at 10 Mbps
2.3 "Link"	OFF	Physical connections unplugged - No IP address obtained
	Flashing Green/Red	Power Up testing
	Green ON	At least one port is connected and an IP address has been obtained
	Green flashing 3 times	All ports are unplugged, but the card has an IP address.
	Green flashing 4 times	Error: Duplicated IP address (*1)
	Green flashing 5 times	The card is performing a BOOTP or DHCP sequence
2.4 "NS"	OFF	The device does not have an IP address or powered off.
	Flashing Green/Red	Power up testing.
	Green ON	The device has at least one established connection (even to the Message Router.)
	Green flashing	The device has not established connections, but has obtained an IP address.
	Red flashing	One or more of the connections in which this device is the target has timed out. This shall be left only if all time out connections are reestablished or if the device is reset.
	Red ON	The device has detected that its IP address is already in use (*1).
2.5 "MS"	OFF	No power is supplied to the device.
	Flashing Green/Red	Power Up testing.
	Green ON	The device is operating correctly.
	Green flashing	The device has not been configured.
	Red flashing	The device has detected a communication error (E r r B).
	Red ON	The device has detected an option unit error (E - 2 3) (*1).

(*1) In case of duplicate IP Address, the LED2.3.is green flashing 4times, LED2.4 and 2.5 are solid red.

3. Installing the IPE001Z

Install the EtherNet/IP™ option to VF-AS1/PS1 as follows.

*When this option is used together with the IO card option, attach this option to the front panel side.

 Mandatory	Turn off the input power of VF-AS1/PS1 and wait for at least 15 minutes and then check that the CHARGE lamp on VF-AS1/PS1 is no longer lit.
---	---

- (1) Turn off input power of VF-AS1/PS1 and wait for at least 15 minutes and then check that the CHARGE lamp on VF-AS1/PS1 is no longer lit.
- (2) Securing the option to the inverter
 - a) Insert a flat-blade screwdriver in each of the two holes at the upper part of the front panel, release the panel mounting tab by pushing the screwdriver down and remove the front panel cover.
 - b) Install the option in the inverter by fitting the tabs on the lower side the option into the slots at the lower part of the inverter front panel.*1
 - c) Make sure the option is securely attached to the inverter. Then check whether the plastic bosses on the inverter case have fitted in the holes at the upper and lower parts of the option.
 - d) Insert the tabs at the lower part of the front cover into the slots at the lower part of the inverter to attach the front cover to the inverter.*1
 - e) Stuck the enclosed "LED name label" in the option LED display part of a front cover.

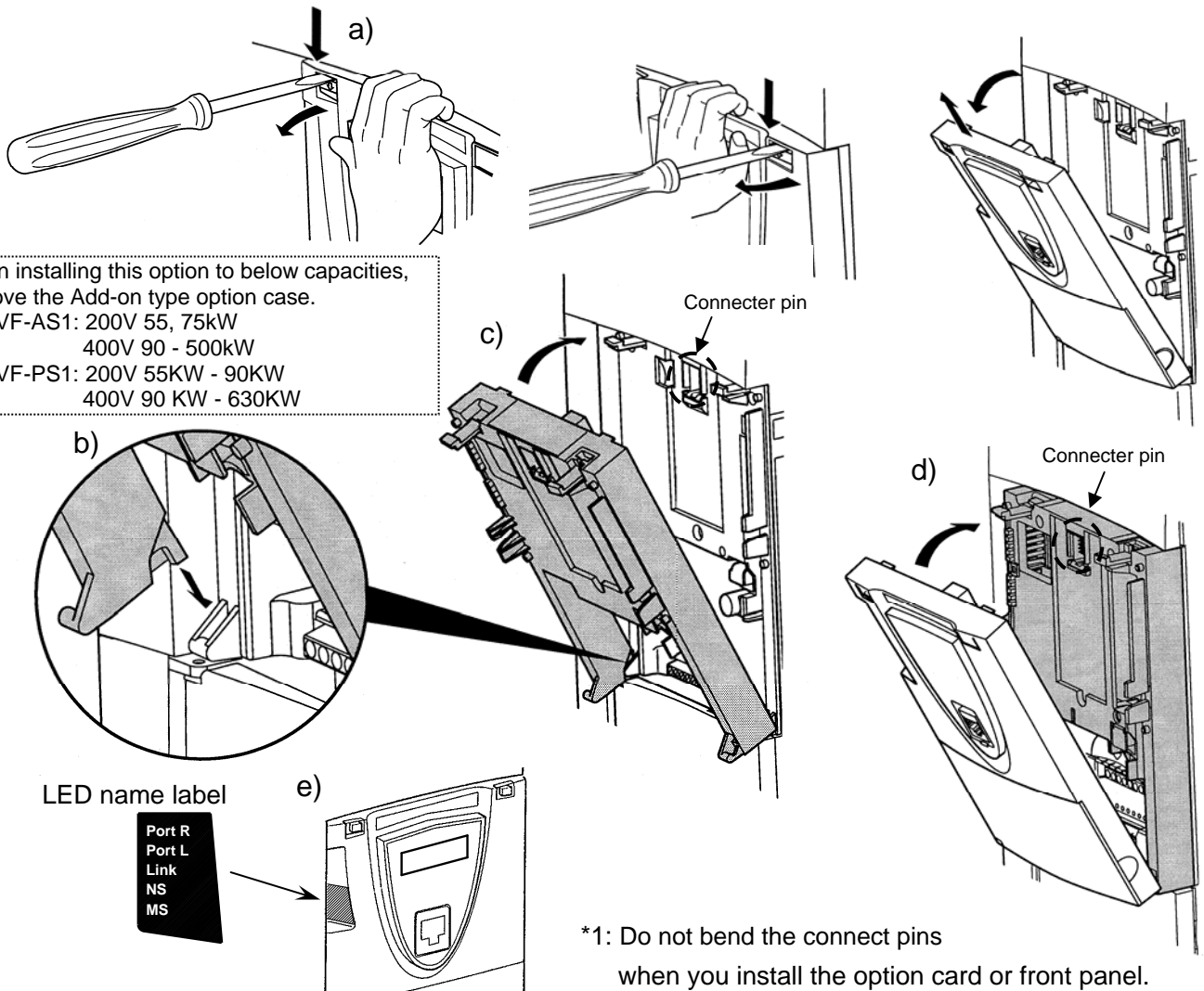

4. Parameters

4.1. Communication parameters

Set up the inverter parameters as follows. These parameters do not take effect until the inverter is reset. If these parameters are not set to correct value, this unit can not work normally.

And configure the option with EDS file. The EDS file can be downloaded from the following web site.

http://www.inverter.co.jp/product/inv/vfas1/ipe/index_i.htm

Title	Communication No.	Function	Description	Factory setting
F821	0821	Rate Setting (*1)	This field is used to set the transmission speed and the transmission mode of the card. 0:Autodetect(default) 1:10Mbps Full 2:10Mbps Half 3:100Mbps Full 4:100Mbps Half	0
F822	0822	Actual Rate (L port)	This field displays the baud rate and the transmission mode currently used by the communication card. (Display only) 0:unconnected	-
F823	0823	Actual Rate (R port)	1:10Mbps Full 2:10Mbps Half 3:100Mbps Full 4:100Mbps Half	-
F792-F799	0792-0799	DEVICE NAME (*1)	16 characters by a hex digit 0h to FFFFh for each of fields. (There are 2 characters per one parameter.) The device name is required if the card uses DHCP to obtain its IP Address.	0,0,0,0 0,0,0,0 (HEX) (*2)
F576	0576	IP mode (*1)	Use this parameter to select the IP address assignment method. 0:Manual 1:BOOTP 2:DHCP	0
F577-F580	0577-0580	IP address (*1)	IP address of the card 0 to 255 for each of fields. These fields are editable when IP mode = 0.	0,0,0,0
F581-F584	0581-0584	IP Mask (*1)	Subnet mask of the card 0 to 255 for each of fields. These fields are editable when IP mode = 0.	0,0,0,0
F585-F588	0585-0588	IP Gate (*1)	Gateway IP address of the card 0 to 255 for each of fields. These fields are editable when IP mode = 0.	0,0,0,0
<ul style="list-style-type: none"> •If the address has been given by a BOOTP or a DHCP server, these fields (IP address IP Mask IP Gate) are read only. •If you enter a value other than [0.0.0.0] (0) (0) (0) (0), dynamic addressing by a BOOTP or DHCP server is disabled. •After dynamic addressing by a BOOTP or DHCP server, the new address value is displayed. 				
F784-F789	0784-0789	MAC address	MAC address display 0 to 255 for each of fields.	-

Title	Communication No.	Function	Description	Factory setting
<i>F849</i>	0849	Communication2 time-out condition selection	0: Disconnection detection 1: When communication mode enabled 2: 1+Driving operation	0.0
<i>F850</i>	0850	Disconnection detection extended time	0.0~100.0 sec.	0.0
<i>F851</i>	0851	Operation at communication error by disconnection	0: Inverter stop, communication command, frequency mode open (by <i>CnOd, FnOd</i>) 1: None (continued operation) 2: Deceleration stop 3: Coast stop 4: Network error (<i>ErrB</i> trip) 5: Preset speed operation (by <i>F852</i> setting)	0
<i>F852</i>	0852	Preset speed operation selection	0:None 1~15:Preset speed operation (by parameter setting)	0
<i>F831-F838</i>	0831-0838	IO Scanner Command data	0: No action 1: FA06 (Communication option command 1) 2: FA23 (Communication option command 2) 3: FA07 (Frequency command, 0.01Hz) 4: FA33 (Torque command, 0.01%) 5: FA50 (Terminal output data from comm.) 6: FA51 (Analog output (FM) data from comm.) 7: FA52 (Analog output (AM) data from comm.) 8: F601 (Stall prevention level, %) 9: F441 (Power running torque limit 1 level, 0.01%) 10: F443 (Regenerative braking torque limit 1 level, 0.01%) 11: F460 (Speed loop proportional gain) 12: F461 (Speed loop stabilization coefficient)	0
<i>F841-F848</i>	0841-0848	IO Scanner Monitor data	0: No action 1: FD01 (Inverter status 1) 2: FD00 (Output frequency, 0.01Hz) 3: FD03 (Output current, 0.01%) 4: FD05 (Output voltage, 0.01%) 5: FC91 (Inverter alarm) 6: FD22 (PID feedback value, 0.01Hz) 7: FD06 (Input terminal status) 8: FD07 (Output terminal status) 9: FE36 (VI/II input, 0.01%) 10: FE35 (RR/S4 input, 0.01%) 11: FE37 (RX input, 0.01%) 12: FD04 (Input voltage (DC detection), 0.01%) 13: FD16 (Speed feedback (real-time value), 0.01Hz) 14: FD18 (Torque, 0.01%) 15: FE60 (My monitor) 16: FE61 (My monitor) 17: FE62 (My monitor) 18: FE63 (My monitor) 19: F880 (Free notes) 20: FD29 (Input power, 0.01kW) 21: FD30 (Output power, 0.01kW) 22: FE14 (Cumulative operation time, 0.01=1 hour) 23: FE40 (FM terminal output monitor) 24: FE41 (AM terminal output monitor)	0
<i>F899</i>	0899	Network option reset setting	0:None 1:Reset option circuit board and inverter	0
-	FE66	Add-on option 1 CPU version (Under side option)	High byte is version. Low byte is revision. For example, When version number 1, and revision number 2 is, panel indication becomes with 1.02. The version of the option with it has equipped can be checked by using the function of <i>F710</i> to <i>F718</i>	-
-	FE67	Add-on option 2 CPU version (Panel side)	(standard monitor display selection). *For details, refer to the inverter instruction manual.	-

(*1): This parameter is effective by reset. Please reset (power supply reset or *F899=1*) after changing a set point.

(*2): The factory default setting parameter (*EEP*) does not work for this parameter.

4.2. *F851*: Communication Loss Action Setting (Network Disconnection)

This parameter sets up the VF-AS1/PS1 response to a loss of communications with the EtherNet/IP™ network.

0: Stop and Communication release

The inverter decelerates the motor to a stop and gives a $\text{E}r$ alarm (the leftmost LED $\text{E}r$ flashes). Commands entered through the network are canceled, and the commands set with parameters $\text{C}n0d$ and $\text{F}n0d$ become effective.

When communications are restored, the $\text{E}r$ alarm is turned off.

1: None

The inverter remains in the state where it was when the problem arose, and it gives a $\text{E}r$ alarm.

2: Deceleration stop

The inverter decelerates the motor to a stop and gives a $\text{E}r$ alarm. Commands entered through the network are not canceled.

4: Emergency stop

The error message $\text{E}r r \text{E}$ is displayed. Commands entered through the network are not canceled.

When communications are restored, the inverter is not restored to working order and the error message $\text{E}r r \text{E}$ does not disappear until the inverter is reset.

5: Preset speed operation command

The drive will run at a preset speed as set up by $\text{F}852$ in the case of a communication loss (with $\text{E}r$ alarm). Commands entered through the network are not canceled.

For example,

If the inverter is set as described below,

$\text{F}851 = 5$ (preset speed operation command)

$\text{F}852 = 8$ (preset speed operation frequency 8)

$\text{F}287$ (preset speed operation frequency 8) = 10 (10Hz)

Operation is carried out as follows.

Network	Operation of the VF-AS1/PS1
Normal conditions	Operates according to commands entered through the network.
↓	↓
Communications loss	Operates at 10Hz.
↓	↓
Restoration	Operates according to commands entered through the network.

5. Command & Setpoint selection (Local/Remote)

Indication to display Local/Remote mode is on the inverter unit (Refer to the inverter instruction manual for details). EtherNet/IP™ option command and setpoint are activated on Remote mode.

Inverters have some switches to select the command and setpoint location. Following figure shows the diagram. Refer to the inverter instruction manual for the parameter in detail.

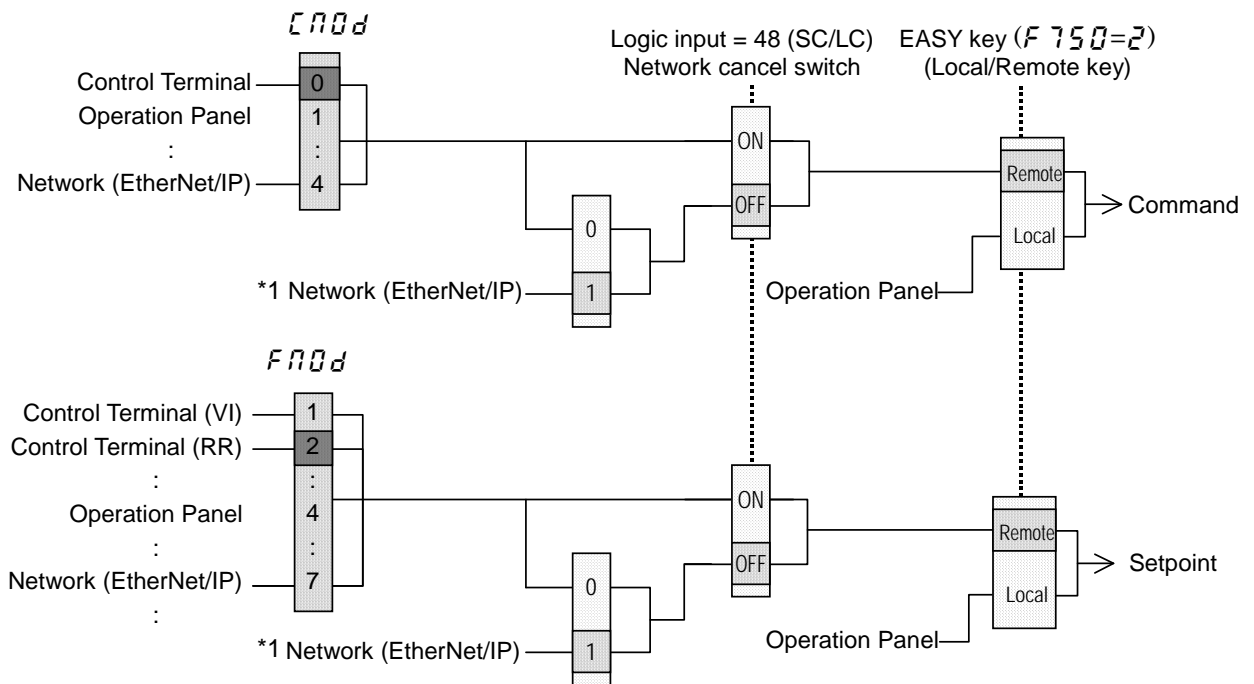

<Example>

The example below shows how to configure the VF-AS1/PS1 for local/remote operation.

- F terminal.....Operating command
- R terminal.....EtherNet/IP™ local/remote (Terminal in this example) switching
- RR/S4 terminal....Operation frequency command

<Wiring>

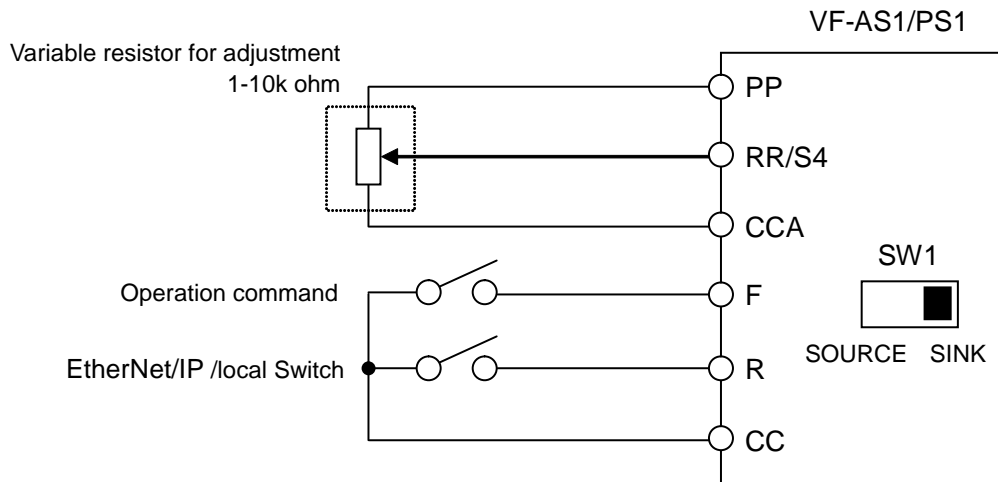

<Parameter setting>

- $F 7 5 \square = 0$ (Command mode selection) = 0 (Terminal board)
- $F 7 5 \square = 2$ (Frequency setting mode selection 1) = 2 (RR/S4)
- $F 1 1 2$ (Input terminal selection 2 (R)) = 48 (Remote/Local control)

<Operation>

R-CC terminal open: VF-AS1/PS1 is controlled as a slave device of The EtherNet/IP™.

R-CC terminal closed:

- F-CC terminal short to RUN
- F-CC terminal open to STOP
- Output frequency is set up by the RR/S4 signal input.

(Note)

When the local (HAND) / remote key ($F 7 5 \square = 2$) is chosen as EASY key selection and the EASY key lamp of an inverter front panel is on, priority is most given to operation by a panel. (Refer to the inverter instruction manual for details).

Note that the HAND mode of the panel has priority over FLN local control.

6. Specifications

Item	Specification
Model number	IPE001Z
Ethernet	Baud-rate: Auto negotiation or manual selection of data rate and duplex can be selected. 10Mbps Full/10Mbps Half/100Mbps Full/100Mbps Half
Service environment	Conforms to VF-AS1/PS1
Ambient temperature	Conforms to VF-AS1/PS1
Storage temperature	Conforms to VF-AS1/PS1
Relative humidity	Conforms to VF-AS1/PS1
Vibration	Conforms to VF-AS1/PS1
Power supply	24VDC supplied from the inverter

7. Warranty

Any part of EtherNet/IP™ communication option that is proved to be defective will be repaired and adjusted free of charge under the following conditions:

1. This warranty applies only to option unit.
2. Any part of the option which fails or is damaged under normal use within twelve months from the date of delivery shall be repaired free of charge.
3. For the following kinds of failure or damage, the repair cost shall be borne by the customer even within the warranty period.
 - i) Failure or damage caused by improper or incorrect use or handling, or unauthorized repair or modification of the option.
 - ii) Failure or damage caused by falling or an accident during transportation after the purchase.
 - iii) Failure or damage caused by fire, salty water or wind, corrosive gas, earthquake, storm or flood, lightning, abnormal voltage supply, or other natural disasters.
 - iv) Failure or damage caused by the use of the EtherNet/IP™ communication option for any purpose or application other than the intended one.
4. All expenses incurred by Toshiba for on-site services shall be charged to the customer, unless a service contract is signed beforehand between the customer and Toshiba, in which case the service contract has priority over this warranty.