TOSVERT VF-AS1

Functions for lift application
Parameter adjustment procedure for braking functions

- Contents -

1. Introduction	2
2. Standard connection for lift application	2
3. Parameter adjustment procedure for braking functions.....	3
4. Setting sample of related parameters.....	4
5. Braking functions	6
5.1. Parameters for braking functions	7
5.2. Execution of "Brake time learning"	9
5.3. Brake timing with maximum load	10
5.4. Abnormal phenomenon and the measures	11

1. Introduction

Thank you for your purchase of the Toshiba inverter "TOSVERT VF-AS1".
 This instruction manual explains the braking functions of VF-AS1 for crane and hoists applications.

2. Standard connection for lift application

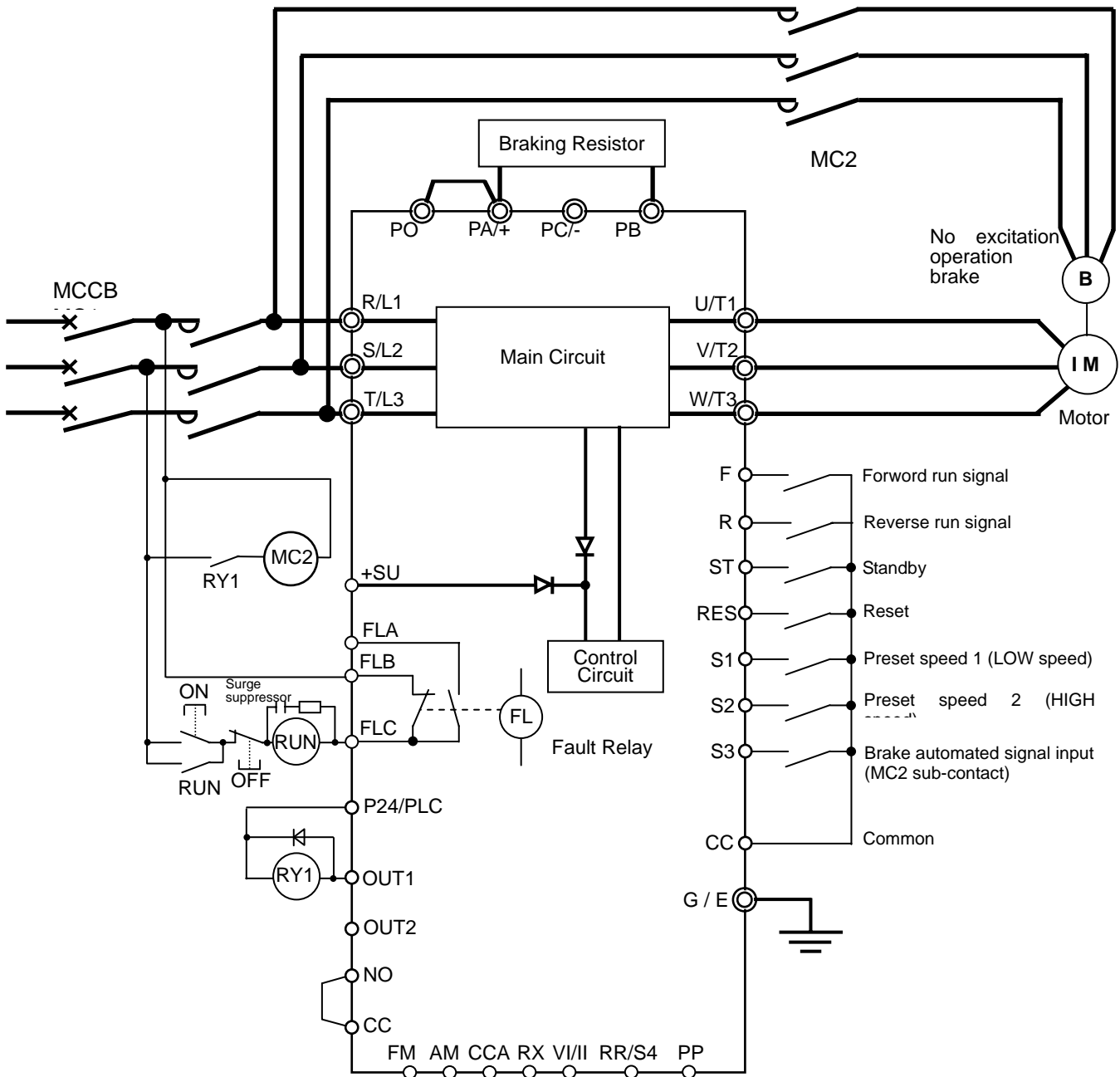

[Operation] By terminal signal

[Speed reference] Preset speed 1 and 2, Operation panel → 3 preset speed

3. Parameter adjustment procedure for braking functions

Set related parameters like as $Cn0d$, $Fn0d$.

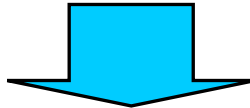

Set vector control parameters (motor constant value) by executing the auto-tuning functions without load.

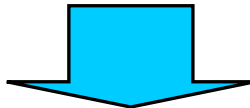

Execute the brake timing learning function without load. This function provides the brake ON/OFF timing as a rough adjustment.

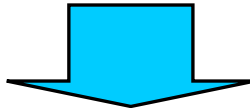

Operate forward/reverse run with maximum load, and confirm that it doesn't have trouble like as 'inverter trip' or 'luggage shifts'.

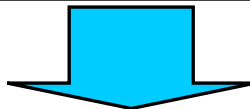

If there is 'inverter trip' or 'luggage shifts', adjust parameters for braking function.

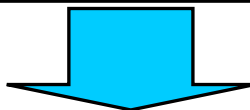

The adjustment of the brake function is completed above.

4. Setting sample of related parameters

Title	Comm. Number	Functions	Setting range	Minimum setting value (Panel/Comm.)	Default value	Setting value	Notes
<i>CnCd</i>	0003	Command mode selection	0 ~ 4	1/1	0	0	0:Terminal input enabled
<i>FnCd</i>	0004	Frequency setting mode selection 1	1 ~ 13	1/1	2	4	4:Operation panel input enabled
<i>Pt</i>	0015	V/f control mode selection	0 ~ 8	1/1	0	4 (*8)	4:Sensorless vector control 2
<i>FH</i>	0011	Maximum frequency	30.0 ~ 500.0Hz	0.1/0.01	80.0	60.0	
<i>UL</i>	0012	Upper limit frequency	0.0 ~ <i>FH</i> Hz	0.1/0.01	60.0	60.0	
<i>LL</i>	0013	Lower limit frequency	0.0 ~ <i>UL</i> Hz	0.1/0.01	0.0	6.0	
<i>Rt</i>	0009	Acceleration time 1	0.1 ~ 6000 sec.	0.1/0.1 (*2)	(*1)	1.0	
<i>dEt</i>	0010	Deceleration time 1	0.1 ~ 6000 sec.	0.1/0.1 (*2)	(*1)	1.0	
<i>sr1</i>	0018	Preset speed operation frequency 1	<i>LL</i> ~ <i>UL</i>	0.1/0.01	0.0	10.0	Operation frequency 1
<i>sr2</i>	0019	Preset speed operation frequency 2	<i>LL</i> ~ <i>UL</i>	0.1/0.01	0.0	60.0	Operation frequency 2
<i>Pb</i>	0304	Dynamic braking selection	0 ~ 2	1/1	0	1	1:Select (braking resistance overload detect)
<i>Pbr</i>	0308	Dynamic braking resistance	0.5 ~ 1000 ohm	0.1/0.1	(*1)	(*3)	
<i>PbCP</i>	0309	Allowable continuous braking resistance	0.01 ~ 600.0kW	0.01/0.01	(*1)	(*4)	
<i>F117</i>	0117	Input terminal function selection 7 (S3)	0 ~ 135	1/1	14	130	130: Brake answer back input
<i>F130</i>	0130	Output terminal function selection 1 (OUT1)	0 ~ 255	1/1	4	68	68: Braking release signal (*8)
<i>F305</i>	0305	Overvoltage limit operation	0 ~ 3	1/1	2	2 (*5)	1:Deselect 2:Select (quick deceleration)
<i>F341</i>	0341	Braking mode selection	0 ~ 3	1/1	0	1	Refer next chapter. (Chapter 5)
<i>F342</i>	0342	Load portion torque input selection	0 ~ 8	1/1	4	4 (*6)	
<i>F343</i>	0343	Hoisting torque bias input (valid only when <i>F342</i> =4)	-250 ~ 250%	1/1	100	100	
<i>F344</i>	0344	Lowering torque bias multiplier	0 ~ 100%	1/0.01	100	60	
<i>F345</i>	0345	Brake release time	0.00 ~ 2.50 sec.	0.01/0.01	0.05	(*7)	
<i>F346</i>	0346	Creeping frequency	<i>F240</i> ~ 20.0Hz	0.1/0.1	3.0	(*7)	
<i>F347</i>	0347	Creeping time	0.00 ~ 2.50 sec.	0.01/0.01	0.10	(*7)	
<i>F348</i>	0348	Braking time learning function	0, 1	1/1	0	(*7)	
<i>F405</i>	0405	Motor rated capacity	0.10 ~ 500.0kW	0.01/0.01	(*1)	(*8)	Refer the installation manual (E6581301 6.22)
<i>F406</i>	0406	Motor rated current	0.1 ~ 2000A	0.1/0.1	(*1)		
<i>F407</i>	0407	Motor rated revolutions	100 ~ 6000min ⁻¹	1/1	(*1)		
<i>F410</i>	0410	Motor constant 1 (torque boost)	0.0 ~ 30.0%	0.1/0.1	(*1)		
<i>F411</i>	0411	Motor constant 2 (no load current)	10 ~ 90%	1/1	(*1)		
<i>F412</i>	0412	Motor constant 3 (leak inductance)	0 ~ 200%	0.1/0.1	(*1)		
<i>F413</i>	0413	Motor constant 4 (rated slip)	0.1 ~ 25.0%	0.1/0.1	(*1)		
<i>F452</i>	0452	Power running stall continuous trip detection time	0.0 ~ 1.0 sec.	0.1/0.1	0.0	0.5(*9)	
<i>F453</i>	0453	Regenerative braking stall prevention mode selection	0, 1	1/1	0	1 (*10)	1:Not stall during regenerative braking
<i>F630</i>	0630	Braking answer waiting time	0.0 ~ 10.0 sec.	0.1/0.1	0.0	0.5(*11)	

- (*1) This parameter value depends on inverter's capacity. Refer the installation manual about the default setting value.
- (*2) Possible to change 0,01 unit by the parameter 'P0' setting. The setting range is 0.01 to 600.0 seconds.
- (*3) Not to need to set this parameter in case of using our recommendation resistor.
Impossible to connect the braking resistor smaller than the minimum allowable resistance value.
- (*4) Set this parameter to specifications of connected braking resistor's capacity.
- (*5) This setting value is that the CPU1 version is V130 or later.
In case of V124 or before, set P5 (Over-voltage limit operation) to 1 (Disabled).
- (*6) This parameter's default setting value is changed at CPU1 V130 or later.
In case of V124 or before, set P4 (Load portion torque input selection) to 4 (P4 enabled).
- (*7) Depends on specifications of motor and brake. The P8 (Braking time learning function) offers the rough setting value. Refer to chapter 5 (Braking functions).
- (*8) In the case of using braking functions (output terminal functions: 68, 69), set P6 (V/f control mode selection) below.
 - 3: Sensor-less vector control 1 --- Possible to use up to 200V-45kW, 400V-75kW.
 - 4: Sensor-less vector control 2
 - 8: PG feedback vector control 2The vector control mode is necessary to set motor constant parameters.
- (*9) This is one of functions to prevent from falling for lift application. This function offers inverter trip by judgement of motor stalling in continuous stall prevention mode. Set the detection time to about 0.5 seconds.
- (*10) This is one of functions to prevent from falling or stop position shifts for lift application. The current/voltage stall prevention mode is invalidity in regenerating mode.
- (*11) Possible to set the waiting time of 'the automated signal input' that is the magnet-contactor of the mechanical brake. This function offers 'E - I' trip when the automated signal isn't back while setting time. Set the waiting time to about 0.5 seconds.

5. Braking functions

The braking function of TOSVERT VF-AS1 is to ensure smooth operation with the motor produces enough torque before the brake is released.

- Starting procedure

At the run command, the inverter makes the motor produce the torque specified with parameter *F 3 4 3*. As soon as a torque output command is issued, a brake release request signal is put out through the brake output terminal. Upon expiration of the brake release time set with *F 3 4 5*, the motor starts to accelerate.

- Stopping procedure

At the stop command, the operation frequency is decreased to the creep frequency set with parameter *F 3 4 6* and the creep frequency is maintained for the creep time set with *F 3 4 7*. While the creep frequency is maintained, the brake release signal is put out through the braking signal output terminal to apply the brake.

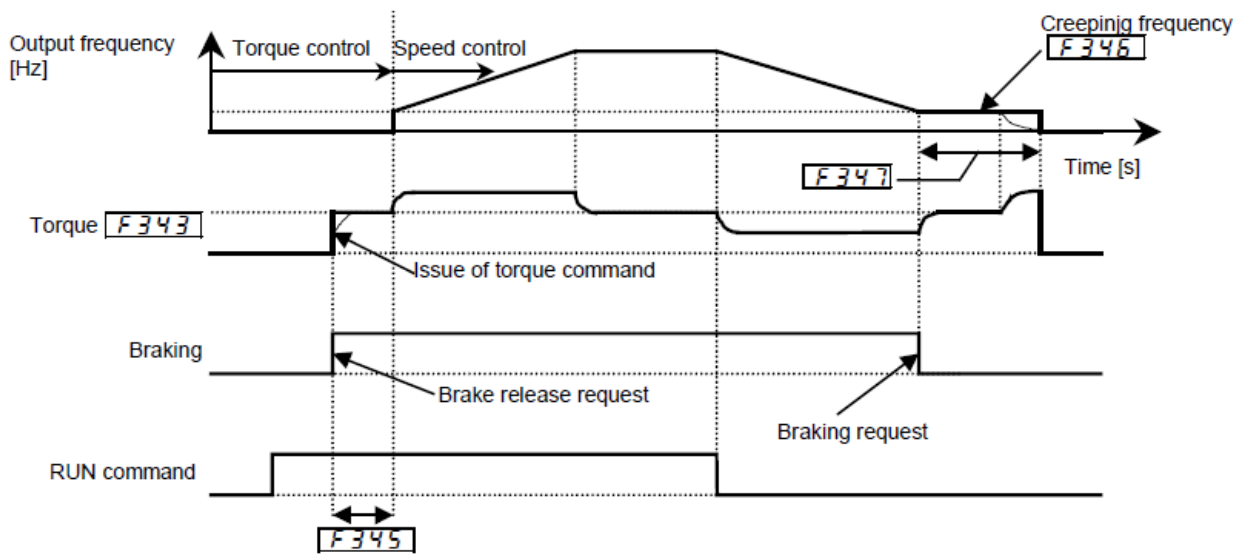

5.1. Parameters for braking functions

TITLE	FUNCTIONS	Setting range	Default setting value	Setting value	Notes
F341	Braking mode selection	0: Deselect 1: Forward winding up 2: Reverse winding up 3: Horizontal operation (counter weight)	0	1	
F342	Load portion torque input selection	0: Disabled 1: VI/II (voltage/current input) 2: RR/S4 (potentiometer/voltage input) 3: RX (voltage input) 4: F343 enabled 5: 2-wire RS485 input enabled 6: 4-wire RS485 input enabled 7: Communications option input enabled 8: A1 (differential current input)	0	4 (*3)	
F343	Hoisting torque bias input (valid only when F342=4)	-250 ~ 250%	100	100	
F344	Lowering torque bias multiplier	0 ~ 100%	100	60	
F345	Brake release time	0.00 ~ 2.50 sec.	0.05	0.05	(*2)
F346	Creeping frequency	F240 ~ 20.0Hz	3.0	3.0	(*1)
F347	Creeping time	0.00 ~ 2.50 sec.	0.10	0.10	(*2)
F348	Braking time learning function	0: Deselect 1: Brake signal learning (0 after adjustment)	0	1	

F341 : Braking mode selection

This parameter is for selection of operation mode of brake function.
Usually, the forward (F terminal) operation is winding up.

F342 : Load portion torque input selection

This parameter is to set the brake releasing torque value that is same as load torque.
Usually, set the fixed F343 (Hoisting torque bias input) value with F342 = 4.

F343 : Hoisting torque bias input

This parameter is hoisting torque bias value that is valid only F342 = 4.
The 100% value depends on F405 (motor rated capacity) and F407 (motor rated revolutions).
Usually, set F343 to 100. In case of some trouble after brake learning, adjust this setting value.

F344 : Lowering torque bias multiplier

The torque bias value when brake released is set by F342 (Load portion torque input selection). When winding down, the torque bias value is multiplied this parameter value.
Usually, a necessary torque in winding down is decreased by squaring the mechanical efficiency.
The hoisting torque bias in winding down at 80% machine efficiency is $0.8 \times 0.8 = 0.64$ (about 60%).
Usually, set F344 = 60 ~ 70.

F345 : Brake release time

The brake release demand signal is output at the same time as outputting the set torque after the starting signal turns on.

After the time set with **F345** (brake release time), it accelerates.

This parameter is set by "Braking time learning function" as a rough adjustment.

F346 : Creeping frequency

After decelerated to **F346** (creep frequency), it becomes a brake close operation after the starting signal turns off. A standard of the setting of the creep frequency is about motor rated slips.

For example, case of 5% slips in 60Hz motor, the creeping frequency is "60Hz*5%=3Hz".

(*1) In case of CPU1 version is V130 or later, this parameter is set as automatically by executed **F348** (Braking time learning function).
Case of V124 or before, set this parameter as same as specifications of actual motor.

F347 : Creeping time

After decelerated to **F346** (creep frequency), it becomes a brake close operation after the starting signal turns off. Moreover, inverter's output frequency keeps a creeping frequency while set **F347** (creeping time).

This parameter is set by "Braking time learning function" as a rough adjustment.

F348 : Braking time learning function

The brake learning function is executed by set **F348** (Braking time learning function) to 1.

Parameters of **F345** (brake release time) and **F347** (creeping time) are set by "Braking time learning function" as a rough adjustment.

(*2) This parameter is set by "Braking time learning function (**F348**)" as a rough adjustment.

(*3) This parameter's default setting value is changed at CPU1 version V130 or later.

Case of V124 or before, set **F342** (Load portion torque input selection) to 4 (**F343** setting is enabled).

5.2. Execution of "Brake time learning"

The brake function of VF-AS1 sets automatically the timing (torque establishment when starting) of the preliminary excitation by motor's constants value.
It is necessary to set related parameter before "brake time learning".

Before executed "brake time learning", the brake timing may not fit a load torque.
Execute "brake time learning" at light load that is no load, 3% of rated load or less.

[Procedure]

- Start after set *F 348* (Braking time learning function) to *1*.
F 341 (Braking mode selection) = *1* (Forward winding up) → Turn on F (forward run signal) terminal
F 342 (Braking mode selection) = *2* (Reverse winding up) → Turn on R (reverse run signal) terminal
- The learning function starts working after operation signal ON.
After starting, it measures *F 345* (Brake release time) automatically.
- After operation signal OFF, the inverter output frequency is decreasing to *F 346* (Creeping frequency). After that, it measures *F 347* (Creeping time) automatically.
- While the learning function executes, the LED display indicates "*U n*" and "operation frequency" each other.
Indication sample 50.0 ↔ U n
- When the brake learning function is completed as normality, the LED display indicates "operation frequency"
Indication sample 0.0
- In stopping with the learning not completed, the LED display indicates "*U n*" and "operation frequency" each other.
In the case of the learning discontinuance, set *F 348* (Braking time learning function) to *1*.
Indication sample 0.0 ↔ U n
- In the case of indicated "*U n 1*" after stopping, it happens "Error of brake time learning function".

Cause of expectation	Countermeasure
- The brake operation is abnormal.	- Not to set the brake signal (function 68, 69) in the contact output terminal.
- Too heavy load	- Not to set <i>F 341</i> (Braking mode selection).
- The mistake is found in the driving operation.	- Learning with a heavy load.

- Case of completed the learning function without error, confirm to drive normally repeating driving/stop by a no load.
Refer "5.4 Abnormal phenomenon and the measures" in case of some trouble (inverter trip or the behavior of the load is abnormal)

5.3. Brake timing with maximum load

The brake timing adjustment at no-load (light load), is completed by the previous chapter. Next confirmation is the brake timing with maximum load.

Please confirm next items.

- Isn't there load gap (shifts) when starting on the winding up, and is the start when the brake is released smooth?
- Isn't there load gap (shifts) when the brake operates?
- Isn't there load gap (shifts) in case of the repetition of the start (run/stop)?
- Does the allophone from the brake when start or stop, or not?
- Does the inverter trip when start or stop, or not?

There is no trouble after confirmation, an adjustment of the brake function is completed.

[Convenient function for adjustment]

When starting, the lift application is necessary to get enough output torque and to adjust brake release timing. When stopping, it is necessary to shutdown the inverter output with being sure brake-ON. Therefore, the state that the motor is restrained to some degree is generated when start/stop. In case of a short restrained time, it happens load shifts. But, in case of long restrained time, the inverter trip is caused by increased motor current.

Please use next parameter when adjustment that can confirm a peak output current.

Usually, a peak output current is about 150% of inverter's rated current.

Title	Function	Setting range	Default setting value	Setting sample	Notes
<i>F578</i>	Constant at the time of filtering	4msec, 8msec~100msec	64	4	Minimum setting value
<i>F709</i>	Standard monitor hold function	0:Real time 1:Peak hold 2:Minimum hold	0	1	-
<i>F710</i>	Standard monitor display selection	0 ~ 70	0	2	Output current
<i>F750</i>	EASY key function	0:Quick mode/standard setting mode switching function 1:Shortcut key 2:Operation panel/remote key 3:Monitor peak minimum hold trigger	0	3	-

The status monitor is changed "Peak hold value of output current" by above parameter settings. This peak value is changed when the peak value of the output current is updated by start/stop. When push the "EASY" key, the peak hold value is reset.

5.4. Abnormal phenomenon and the measures

Abnormal phenomenon and the measures (adjustment item) according to load and operating condition

Load condition	Operating condition	Abnormal phenomenon	Countermeasure (adjustment item)
No-load	At start	When winding down operation, wind down after a little winding up.	<ol style="list-style-type: none"> 1. Set $F\ 3\ 4\ 5$ (Brake release time) to short value. 2. Set $F\ 3\ 4\ 4$ (Lowering torque bias multiplier) to 5% down. 3. Set $F\ 3\ 4\ 3$ (Hoisting torque bias input) to 5 ~ 10% down.
No-load or load	At start	When winding up operation, it happens a little load gap/shift (a little winding down).	<ol style="list-style-type: none"> 1. Set torque bias value of $F\ 3\ 4\ 2$ (Load portion torque input selection) and $F\ 3\ 4\ 3$ (Hoisting torque bias input) to increased 10 ~ 20%.
No-load or load	At start or stop	When winding up operation with inching, it happens a little load gap/shift (a little winding down).	<ol style="list-style-type: none"> 1. Set $F\ 3\ 4\ 5$ (Brake release time) to short value.

[Notice of adjustment]

When adjust $F\ 3\ 4\ 5$ (Brake release time) and $F\ 3\ 4\ 7$ (Creeping time), these setting value have to be changed step by step.

If these values are too large or small, the load may fall in worst case because of not matched "brake operation" and "generating motor torque" timing.