

**TOSHIBA**

UM-TS03\*\*\*-E008

**PROGRAMMABLE CONTROLLER**

**PROSEC T-SERIES**

**COMPUTER LINK FUNCTION  
OPERATION MANUAL**

[Main Menu](#)  
[Contents](#)

TOSHIBA CORPORATION

---

---

## ***Safety Precautions***

---

---

This manual explains the specification and operation of Toshiba's T-series Programmable Controller's Computer Link. Read this manual carefully before using the Computer Link. Besides this manual, read the following manuals and descriptions before operation, if necessary, for your better understanding.

### **General Information**

1. The T-series Programmable Controller (hereafter called T-series PLC) has been designed and manufactured for use in an industrial environment. However, the T-series PLC is not intended to be used for systems which may endanger human life. Consult Toshiba if you intend to use the T-series PLC for a special application, such as transportation machines, medical apparatus, aviation and space systems, nuclear controls, submarine systems, etc.
2. The T-series PLC has been manufactured under strict quality control. However, to keep safety of overall automated system, fail-safe systems should be considered outside the T-series PLC.
3. In installation, wiring, operation and maintenance of the T-series PLC, it is assumed that the users have general knowledge of industrial electric control systems.  
If this product is handled or operated improperly, electrical shock, fire or damage to this product could result.
4. This manual has been written for users who are familiar with Programmable Controllers and industrial control equipment.  
Contact Toshiba if you have any questions about this manual.
5. Sample programs and circuits described in this guide are provided for explaining the operations and applications of the T-series PLC. You should test completely if you use them as a part of your application system.

### **Hazard Classifications**

In this manual, the following two hazard classifications are used to explain the safety precautions.

 **WARNING** Indicates a potentially hazardous situation which, if not avoided, could result in death or serious injury.

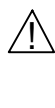
 **CAUTION** Indicates a potentially hazardous situation which, if not avoided, may result in minor or moderate injury. It may also be used to alert against unsafe practices.

Even a precaution is classified as CAUTION, it may cause serious results depending on the situation. Observe all the safety precautions described on this manual.

### CAUTION

1. When you attempt to perform force outputs, RUN/HALT controls, etc. during operation, carefully check for safety.
2. Turn off power before installing or removing any units, modules, racks or terminal blocks. Failure to do so can cause electrical shock or damage to the T-series PLC and related equipment.
3. Sample programs and circuits described in this manual are provided for explaining the operations and applications of the T-series PLC. You should test completely if you use them as a part of your application system.

### Note symbols

Users of this manual should pay attention to information preceded by the following symbol.



Calls the reader's attention to information considered important for full understanding of the procedures and/or operation of the equipment.

Copyright 1994 by Toshiba Corporation  
Tokyo, Japan

Publication number: UM-TS\*\*\*E008  
1st edition Feb. 1994, 4th edition Dec. 1998

IBM is registered trademark of International Business Machines Corporation

---

# Contents

1. How to read this manual.....	1
1.1 Inside this manual.....	1
1.2 Related manual.....	1
2. Overview.....	2
2.1 Features.....	2
2.2 System configuration.....	2
2.3 Communication overview.....	3
3. Transmission mode settings.....	4
3.1 Setting procedure.....	4
4. Cable connections.....	7
4.1 Computer Link port.....	7
4.2 One-to-one configuration.....	8
4.3 One-to-N configuration.....	10
5. Computer Link protocol.....	13
5.1 Message Format.....	13
5.2 Transmission rules.....	14
5.3 Creation of checksum.....	16
5.4 Internal process flow.....	16
6. Commands.....	17
6.1 List of commands.....	17
6.2 Computer Link Error Response (CE).....	18
6.3 PLC Error Response (EE).....	19
6.4 Test (TS).....	22
6.5 PLC Status Read (ST).....	23
6.6 PLC Error Status Read (ER).....	25
6.7 Data Read (DR).....	26
6.8 Data Write (DW).....	28
6.9 Expanded File Register Read (MR).....	30
6.10 Expanded File Register Write (MW).....	31
6.11 System Information 1 Read (SR).....	32
6.12 System Information 2 Read (S2).....	34

# Contents

---

6.13 Diagnostic Message Read (TR).....	37
6.14 Clock-calendar Read (RT) .....	39
6.15 Clock-calendar Write (WT).....	40
6.16 PLC Control (EC) .....	41
6.17 System Information Block Read (BR).....	43
6.18 Program Block Read (RB) .....	45
6.19 Comment Block Read (CR) .....	47
6.20 System Information Block Write (BW) .....	49
6.21 Program Block Write (WB).....	50
6.22 Comment Block Write (CW).....	51
7. Sample communication programs .....	52
7.1 Simple send/receive test .....	52
7.2 Send/receive test with sum check .....	53
7.3 Program up-loading .....	54
7.4 Program down-loading .....	55
Appendices.....	56
A.1 Transmission specifications .....	56
A.2 RS485/RS232C converter .....	57

## 1. How to read this manual

This section outlines this manual to provide a helpful head start before you begin.

### 1.1

#### Inside this manual

This manual provides all the information you need to wire, set-up and operate the T-series Programmable Controller's Computer Link function. In this manual, the T-series Programmable Controllers are referred as PLC.

This manual is divided into seven main sections and appendices:

**1. How to read this manual** (this section)

**2. Overview** introduces the features and overview of the Computer Link function.

**3. Transmission mode settings** describes how to set the transmission mode of the T-series Programmable Controllers.

**4. Cable connections** describes how to connect between the host computer and T-series Programmable Controllers.

**5. Computer Link protocol** gives the general information for the Computer Link protocol.

**6. Commands** explains the function and message format of each command in detail.

**7. Sample communication programs** provides some sample programs for the host computer.

**Appendices** contain the specifications of the Computer Link interface and the description of the RS485/RS232C converter which can be used with the Computer Link function.

### 1.2

#### Related manual

The following related manuals are available for the T-series Programmable Controllers.

T1/T1S User's Manual - Basic Hardware and Function (UM-TS01\*\*\*-E001)

T1/T1S User's Manual - Expansion I/O (UM-TS01\*\*\*-E002)

T1/T1S User's Manual - Communication Function (UM-TS01\*\*\*-E003)

T2E User's Manual (UM-TS02E\*\*\*-E001)

T2N User's Manual (UM-TS02N\*\*\*-E001)

T2E/T2N User's Manual - Communication Function (UM-TS02E\*\*\*-E003)

T3 User's Manual - Hardware (UM-TS03\*\*\*-E002)

T3 User's Manual - Functions (UM-TS03\*\*\*-E003)

T3H User's Manual (UM-TS03\*\*\*-E032)

T-series Instruction Set (UM-TS03\*\*\*-E004)

T-PDS (DOS) Basic Operation Manual (UM-TS03\*\*\*-E006)

T-PDS (DOS) Command Reference Manual (UM-TS03\*\*\*-E007)

T-PDS (DOS) Ver. 2.1 Expanded Functions (UM-TS03\*\*\*-E028)

T-PDS for Windows Operation Manual (UM-TS03\*\*\*-E038)

## 2. Overview

---

### 2. Overview

This section introduces the features and overview of the Computer Link function.

#### 2.1

**Features** Using the Computer Link function, you can connect a host computer to one or more PLC and execute the following functions.

- Reading data (register/device value) from PLC
- Writing data (register/device value) into PLC
- Monitoring PLC operation status (RUN/HALT/ERROR)
- Controlling PLC operation mode (RUN/HALT)
- Up-loading PLC program
- Down-loading PLC program

#### 2.2

**System configuration** With the Computer Link system, up to 32 PLCs can be linked to a host computer, through standard RS485 interface. With this system, the maximum transmission distance (total) is 1 km.  
If the host computer uses an RS232C interface, the RS485/RS232C converter (ADP-6237B) can be used to adapt.

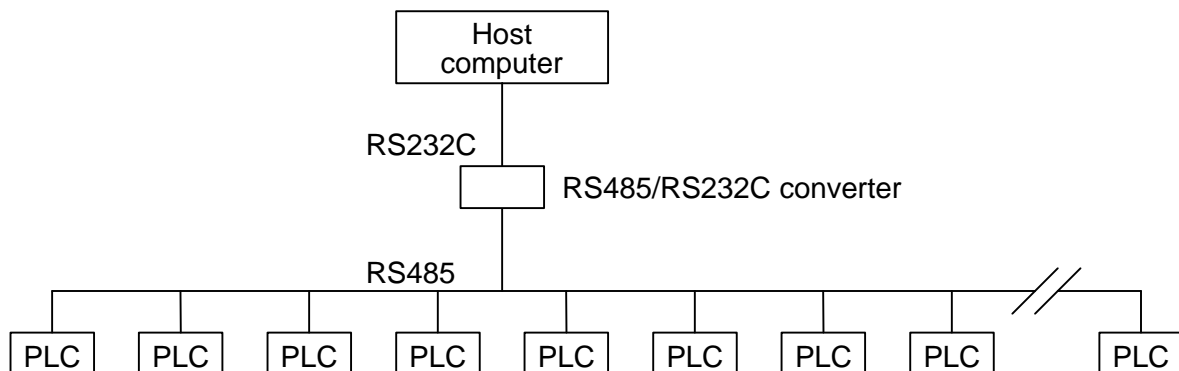

Number of PLCs: 32 maximum  
Transmission distance: 1 km maximum (RS485 total)  
15 m maximum (RS232C)

## 2.3

## Communication overview

In the Computer Link system, each PLC waits for requests issued by the host computer. When a request is generated, each PLC checks the station number of the request. The PLC with the matching station number processes the request and returns the response, while the other PLCs continue to stand by. This is why each PLC must have a unique station number. Otherwise more than one PLC may attempt to process the request, resulting in faulty response.

The following diagram illustrates the processing sequence executed when a request to station number 3 is issued:

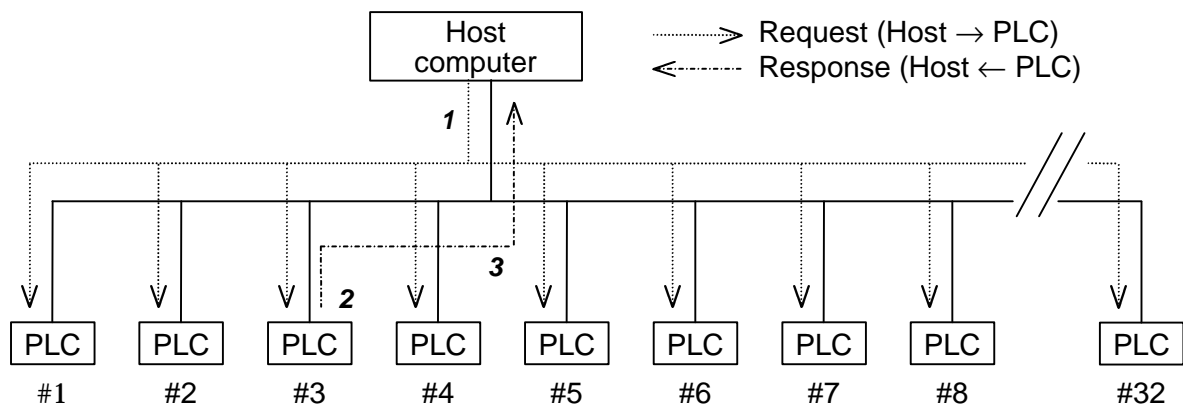

- 1** Request is sent from the host computer to PLCs (request to station #3 in this example).
- 2** Request is interpreted and processed in the PLC which has the same station number as request (station #3 PLC in this example).
- 3** Processing result is returned as response to the host computer.



## 3. Transmission mode settings

---

### 3. Transmission mode settings

The transmission mode settings are stored in the PLC memory. This section describes how to set the transmission mode of the PLC.

3.1  
Setting procedure    PLC's transmission mode is set by using T-series PLC Programming software (T-PDS). The transmission mode of PLCs and the host computer must be matched.

**NOTE**  
▼▲    Refer to T-PDS Operation Manual for detailed explanation for the T-PDS operation.

- (1) Connect the PLC and the T-PDS through PLC's programmer port by using optional cable.
- (2) Start up the T-PDS.
- (3) Change the T-PDS to Online mode. The screen shown below is T-PDS's main menu screen.

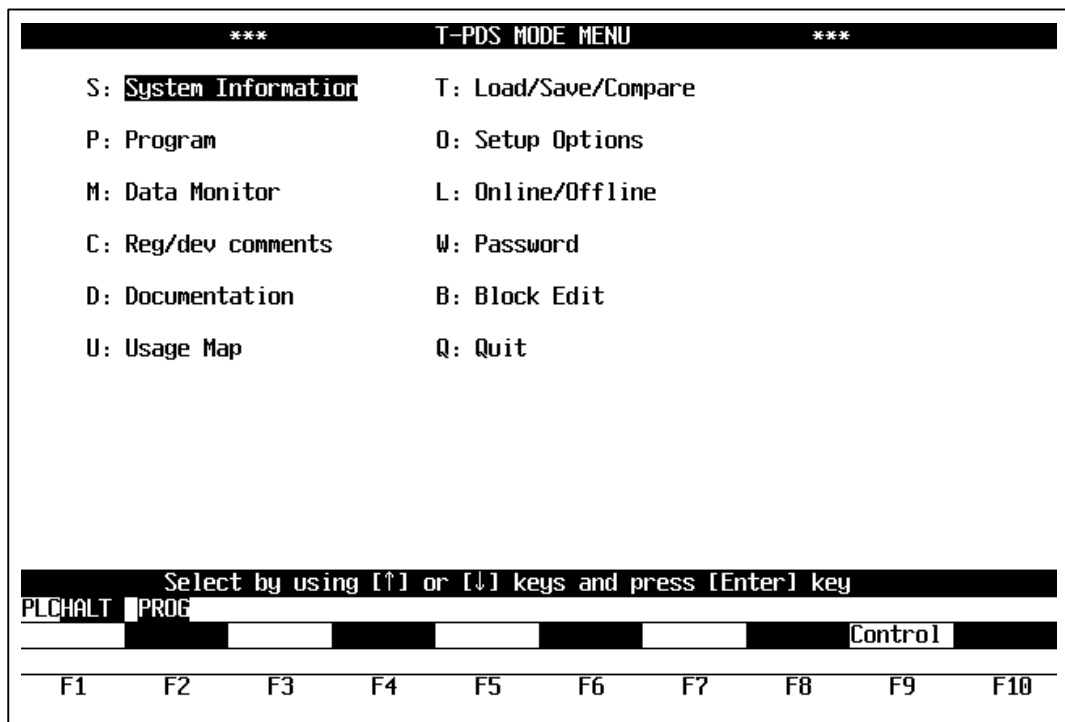

- (4) If your PLC is in RUN mode, turn the PLC to HALT mode to enable to edit its system parameters.

### 3. Transmission mode settings

- (5) Select "S: System Information" from the main menu, then select "P: System Parameters" from the System Information sub-menu.

PLCHALT   PROG   SysPar Edit   Next   DiagRst           Control   Cancel									
F1	F2	F3	F4	F5	F6	F7	F8	F9	F10
<System Parameters>									
1. Program ID	[	]						8. Error Status	
2. System Comments	[	]							
3. Memory Capacity			10kS/	4kW					
4. Steps Used			9					9. Diagnostic Message	
5. PLC Type			T2E						
6. PLC OS Version			Ver. 1.01					10. Date & Time	
								[98-12-15] (yy-mm-dd)	
7. T-PDS Version			Ver. 2.1e					[22:52:05] (hh:mm:ss)	

- (6) Press F1 (Edit) then press F2 (Next) to move into the Computer Link transmission mode setting.

PLCHALT   PROG   SysPar   Edit   Next   Write           AllClr   Clear   Control   Cancel									
F1	F2	F3	F4	F5	F6	F7	F8	F9	F10
<System Parameters>									
11. Program Size Setting	[	11]	kSteps					14. Scan Time Setting	[
									1]x10mS
12. Sampling Buffer Size	[		8]	kWords				15. Subprogram Execution Time	
								1 ~ 100 mS	[
									1]mS
13. Retentive Memory Area								16. Timer Interrupt Interval	
			RW000	~	[	]		2 ~ 1000 mS	[
			T000	~	[	]			1]mS
			C000	~	[	]			
			D0000	~	[	]			
14. 10mS Timer			T000	~	[	63]		17. Computer Link Settings	
								Station No.	[
									1]
								Baud rate	[
									9600]BPS
								Parity	Non
									Odd
									Even
								Data length	[
									8]Bit
								Stop bit	<u>1</u>
									2
15. Start Mode			<u>S</u> tanby						
									Auto

### 3. Transmission mode settings

(7) Move cursor to "17. Computer link Settings", and set Station No, Baud rate, Parity, Data length and Stop bit.

Station No.: 1 to 32  
 Baud rate: 300, 1200, 2400, 4800, 9600 or 19200 bps  
 Parity: Non, odd or even  
 Data length: 7 or 8 bits  
 Stop bit: 1 or 2 bits



If you will use the T-PDS through the Computer Link port, Baud rate, Data length and Stop bit should be set as follows.

Because these settings are fixed on the T-PDS.

Baud rate: 9600 bps  
 Data length: 8 bits  
 Stop bit: 1 bit

(8) When necessary settings are finished, press F3 (Write) to write the setting information into the PLC. The following confirmation message window will appear on the screen.

<System Parameters>

<p>11. Program Size Setting [10]kSteps</p> <p>12. Sampling Buffer Size [ 8]kWords</p> <p>13. Retentive Memory Area</p> <p style="margin-left: 20px;">RW000 ~ [ ]</p> <p style="margin-left: 20px;">T000 ~ [ ]</p> <p style="margin-left: 20px;">C000 ~ [ ]</p> <p style="margin-left: 20px;">D0000 ~ [ ]</p> <p>14. 10mS Timer</p> <p style="margin-left: 20px;">T000 ~ [ 63]</p> <p>15. Start Mode</p> <p style="margin-left: 40px;">Stanby    Auto</p>	<p>14. Scan Time Setting [ 1]x10mS</p> <p>15. Subprogram Execution Time</p> <p style="margin-left: 20px;">1 ~ 100 mS [ 1]mS</p> <p>16. Timer Interrupt Interval</p> <p style="margin-left: 20px;">2 ~ 1000 mS [ 1]mS</p> <p>17. Computer Link Settings</p> <p style="margin-left: 20px;">Station No. [ 5]</p> <p style="margin-left: 20px;">Baud rate [ 9600]BPS</p> <p style="margin-left: 20px;">Parity     Non Odd Even</p> <p style="margin-left: 20px;">Data length [ 8]Bit</p> <p style="margin-left: 20px;">Stop bit    1    2</p>
--	---

Execute ?

V: Yes    N: No

PLCHALT	PROG	SysPar	Edit	Write					Cancel
F1	F2	F3	F4	F5	F6	F7	F8	F9	F10

(9) Confirm each setting and press [Enter] key.  
 Now, the transmission mode settings have been completed.

### 4. Cable connections

This section describes how to connect between a host computer and PLCs. The details of the Computer Link port provided on the PLC is described first, then cable connections depending on the configurations are explained.

#### 4.1

**Computer Link port** The Computer Link uses 4-wire RS485 interface. A standard 15-pin female connector is provided on the PLC's front panel as the Computer Link port. The following table shows the pin assignment of this Computer Link port.

Pin No.	Signal name	Description	Signal direction
1	FG	Protective ground	PLC — Host
7	SG	Signal ground	PLC — Host
3	TXA	Transmitted data	PLC → Host
11	TXB		
2	RXA	Received data	PLC ← Host
10	RXB		
5	RTSA	Request to send	PLC → Host
13	RTSB		
4	CTSA	Clear to send	PLC ← Host
12	CTSB		

**NOTE**  



- (1) Refer to the T2E/T2N User's Manual -Communication Function- for the pin assignment of the T2E and T2N computer link port.
- (2) Refer to the T1/T1S User's Manual -Communication Function- for the pin assignment of the T1 and T1S computer link port.

## 4.Cable connections

### 4.2

One-to-one configuration When one PLC is connected to a host computer, the cable connections should be as follows.

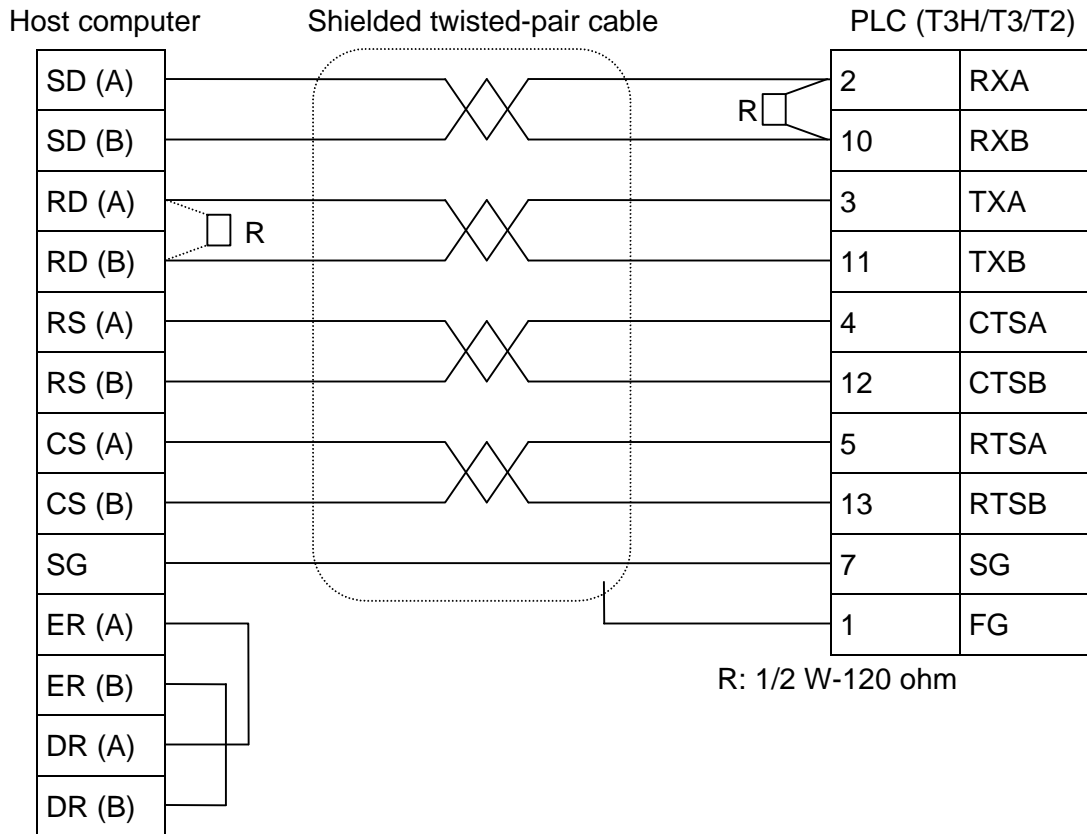
RS485 direct connections:



- (1) Connect R (1/2 W-120 ohm) between RXA and RXB on the PLC side.
- (2) If the host computer has built-in termination resistors, set to connect the built-in resistors.  
Otherwise, connect R (1/2 W-120 ohm) between RD (A) and RD (B) externally.
- (3) For noise immunity, use shielded twisted-pair cable. The cable shield should be connected to FG (pin 1) or ground of PLC side.
- (4) If CTS (A/B), RTS (A/B) are not used, connect them each other on the PLC side as follows.  
CTSA – RTSA  
CTSB – RTSB

Using RS485/R232C converter (ADP-6237B):

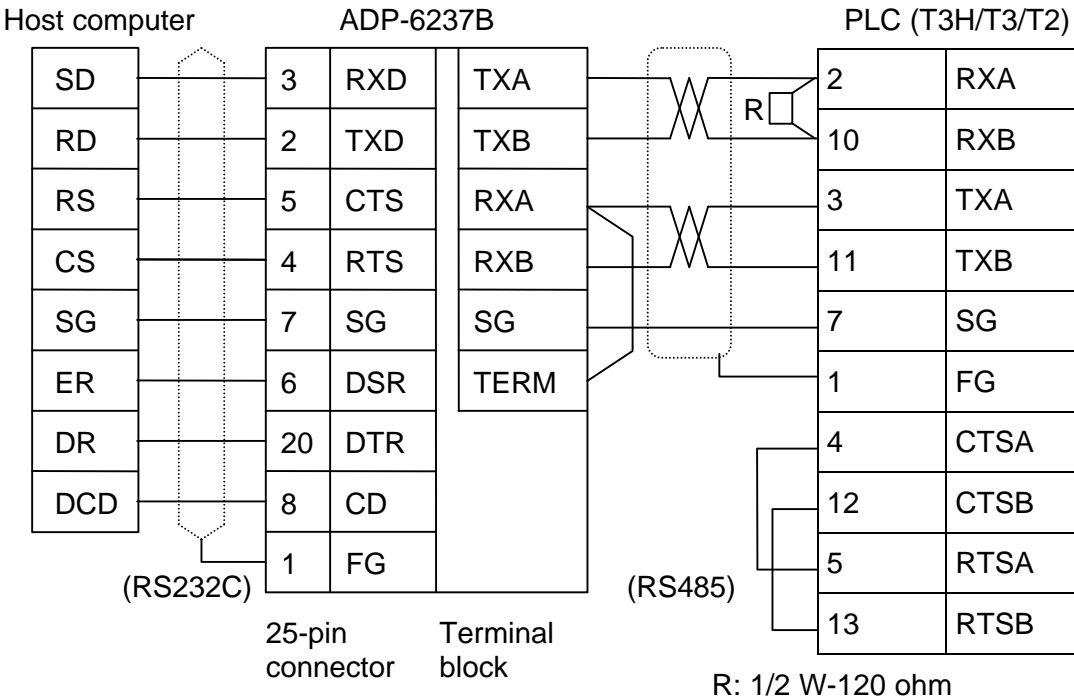

- (1) Connect R(1/2 W-120 ohm) between RXA and RXB on the PLC side.
- (2) Connect RXA and TERM on the converter (ADP-6237B) side to use built-in termination resistor.
- (3) For noise immunity, use shielded twisted-pair cable. The cable shield should be connected to FG (pin 1) or ground of PLC side.

**NOTE**  
 ▼▲▼ For details of the RS485/RS232C converter (ADP-6237B), see Appendix A.2.

## 4.Cable connections

---

### 4.3

One-to-N configuration When two or more PLCs are connected to a host computer, the cable connections should be as follows. (Up to 32 PLCs can be connected on a system)

The transmission line configuration of the Computer Link system is party line. Therefore only two terminations are allowed.

(Available configuration)

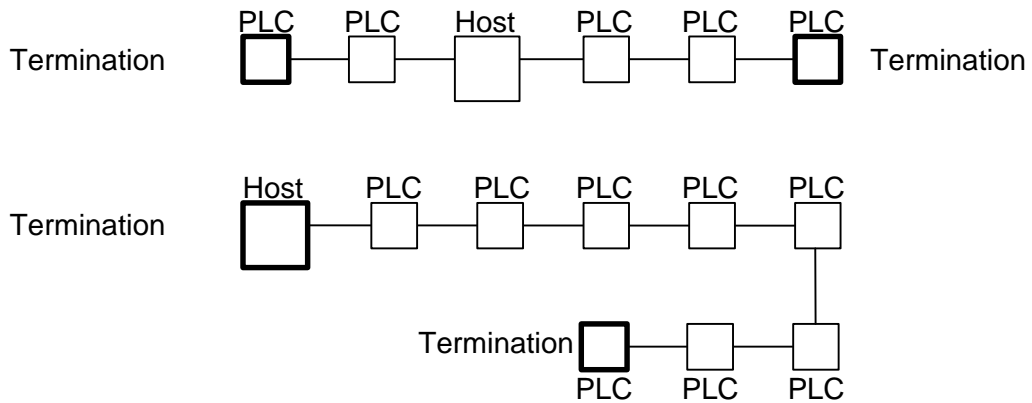

(Unavailable configuration)

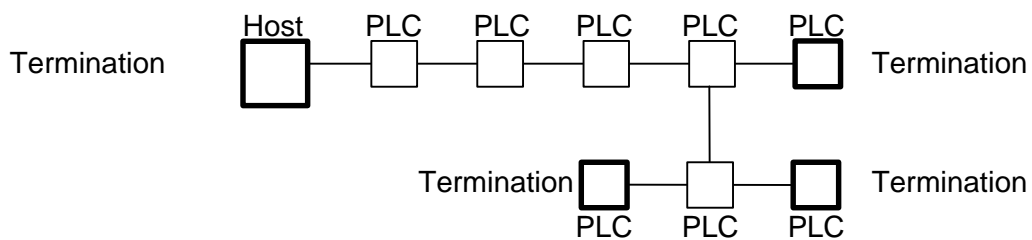

Termination resistors (1/2W-220 ohm) should be connected between TXA and TXB, and RXA and RXB, as each end of the line (termination stations).

RS485 direct connection:

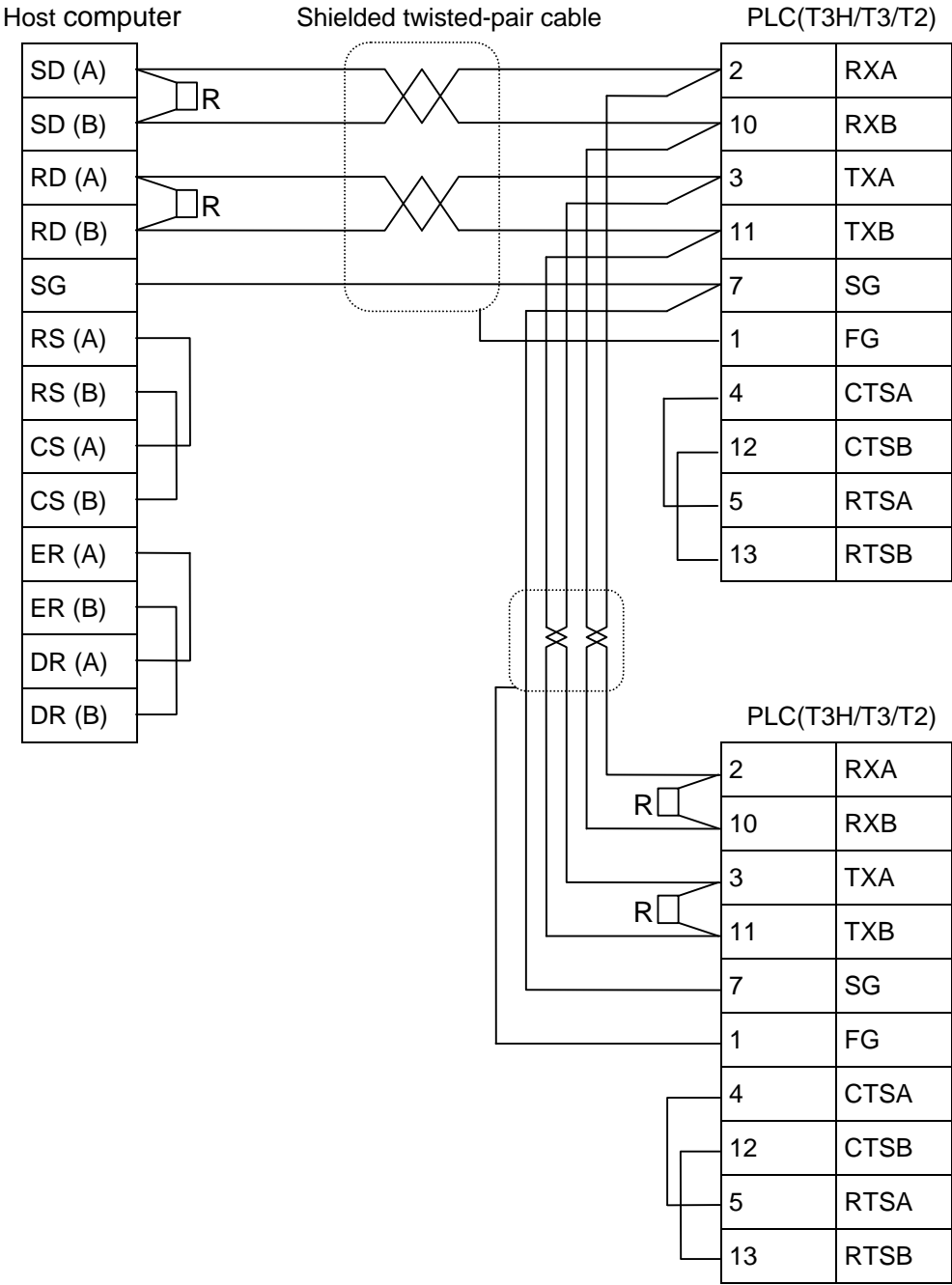

R: 1/2 W-120 ohm

- (1) Connect R (1/2 W-220 ohm) between TXA and TXB (or SD (A) and SD (B)), and between RXA and RXB (or RD (A) and RD (B)) at each termination station.
- (2) For noise immunity, use shielded twisted-pair cable. The cable shield should be connected to FG (pin 1) or ground at one end only.
- (3) Connect CTSA and RTSA, CTSB and RTSB on each PLC.
- (4) Use terminal blocks to branch off the line. The branch should not exceed 3m cable length form the terminal block to the PLC or the host computer.



## 4.Cable connections

Using RS485/R232C converter (ADP-6237B):

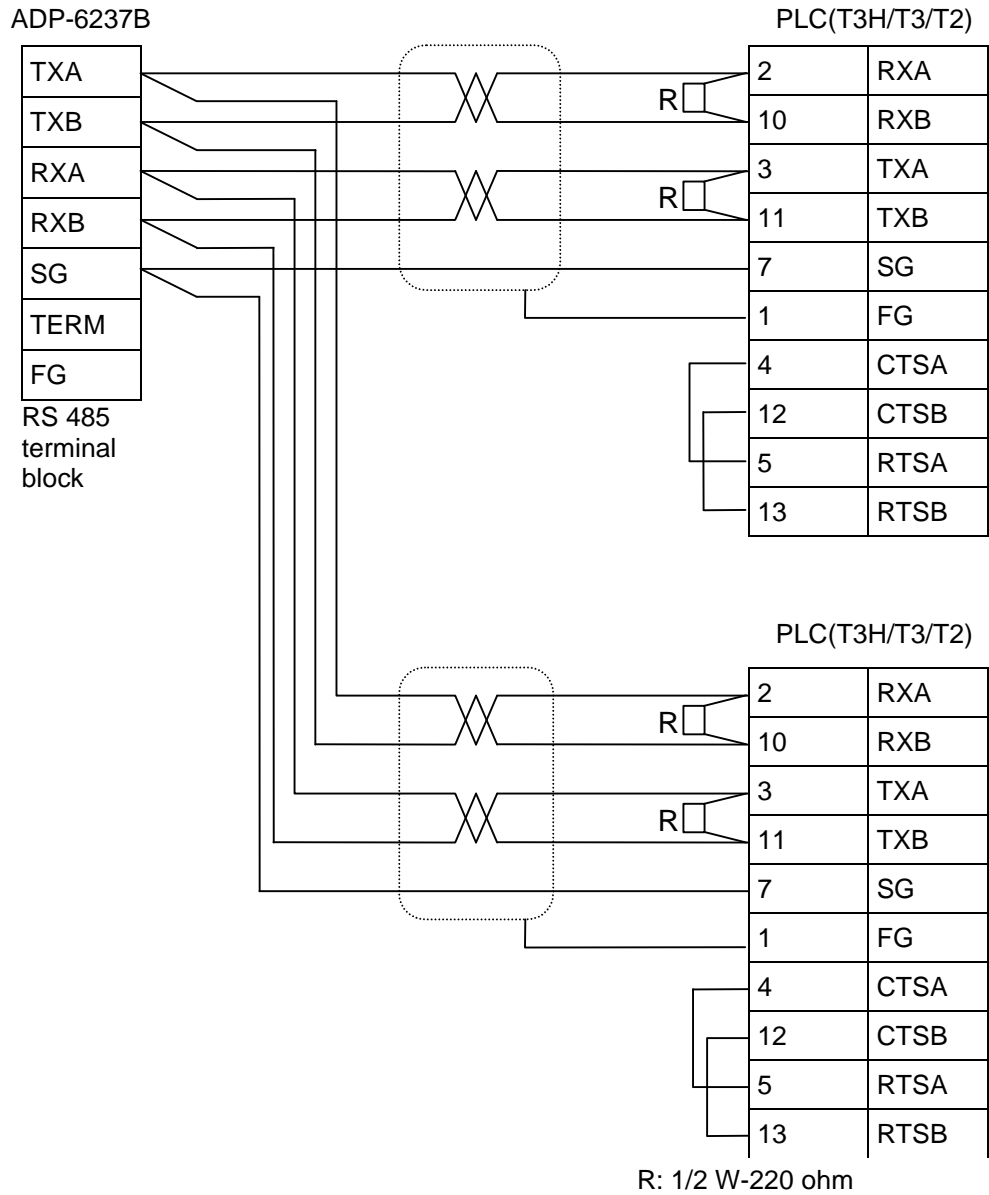

- (1) Connect R (1/2 W-220 ohm) between TXA and TXB (or SD (A) and SD (B)), and between RXA and RXB (or RD (A) and RD (B)) at each termination station.
- (2) For noise immunity, use shielded twisted-pair cable. The cable shield should be connected to FG (pin 1) or ground at one end only.
- (3) Connect CTSA and RTSA, CTSB and RTSB on each PLC.
- (4) Use terminal blocks to branch off the line. The branch should not exceed 3 m cable length from the terminal block to the PLC or the host computer.

**NOTE**  
▼▲▼

- (1) Refer to Section 4.2 for RS232C side connections.
- (2) For details of the RS485/RS232C converter (ADP-6237B), see Appendix A.2.

5. Computer Link Protocol

This section gives the general information for the Computer Link protocol.

5.1 Message format The T-series PLC uses the following message format.

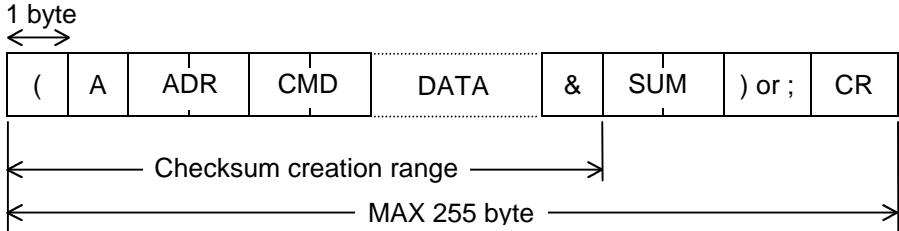

Text contents

- ( ----- Start code (H28) - 1 byte
- A ----- Format identification code (H41) - 1 byte
- ADR --- Station number - 2 bytes  
01 (H3031) through 32 (H3332)
- CMD --- Command - 2 bytes
- DATA-- Data field - depending on the command
- & ----- Checksum delimiter (H26) - 1 byte
- SUM --- Checksum - 2 bytes  
ASCII code of the lowest one byte of the sum obtained by adding from the start code "(" to the checksum delimiter "&"
- ) ----- End code (H29) - 1 byte
- ; ----- End code (H3B) - 1 byte  
in case of halfway of entire data
- CR----- Carriage return code (H0D) - 1 byte

**NOTE**  
▼▲▼

- (1) The maximum message text length is limited to 255bytes.
- (2) The Checksum delimiter and Checksum data of request text can be omitted.

## 5.Computer Link protocol

---

### 5.2

Transmission rules The following transmission rules apply to the Computer Link communication.

- (1) The PLC is always waiting for a request command from the host computer. The PLC will not transmit any text without a request.
- (2) All space codes (H20) are ignored.  
If space codes (H20) are included in the request text issued from the host computer, they are ignored. However, the space codes are included in checksum calculation.

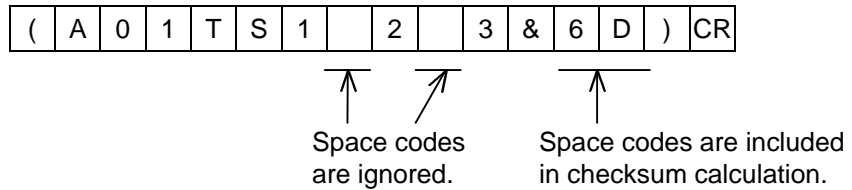

- (3) Checksum can be omitted in the request text issued from the host computer.
- (4) Checksum is always attached to the response text issued from the PLC.

Request text

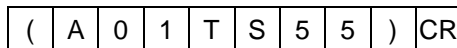

Response text

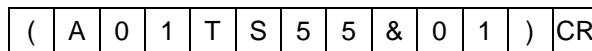

↑  
Response text always includes  
Checksum and the delimiter code (&).

- (5) 7 or 8-bit ASCII is used for all request/response text.
- (6) The PLC ignores all the data received before the start code "(".
- (7) Reception is completed only after the end code, ")" or ";", and CR have been received. If the end code without CR, or vice versa, is received, it becomes communication error.
- (8) The PLC checks the request text reception time. If the reception time, from the start code "(" to CR, exceeds the time limit, it becomes no response from the PLC. The following table shows the time limit in each baud rate.

Band rate	Time limit
300 bps	30 sec.
1200 bps	8 sec.
2400 bps	4 sec.
4800 bps	2 sec.
9600 bps	1 sec.
19200 bps	0.5 sec.

- (9) After one PLC finished to send the response, other PLCs cannot send any data during the inhibited time. The host computer should send the next request after the inhibited time from the previous response reception. The following table shows the inhibited time in each baud rate.

Band rate	Inhibited time
300 bps	40 msec.
1200 bps	20 msec.
2400 bps	10 msec.
4800 bps	10 msec.
9600 bps	10 msec.
19200 bps	10 msec.

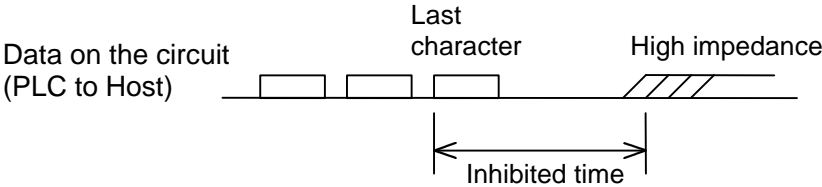

## 5.Computer Link protocol

### 5.3

#### Creation of checksum

Checksum is the ASCII code of the lower two digits of the sum obtained by adding the hexadecimal data from the start code "(" to the checksum delimiter "&".

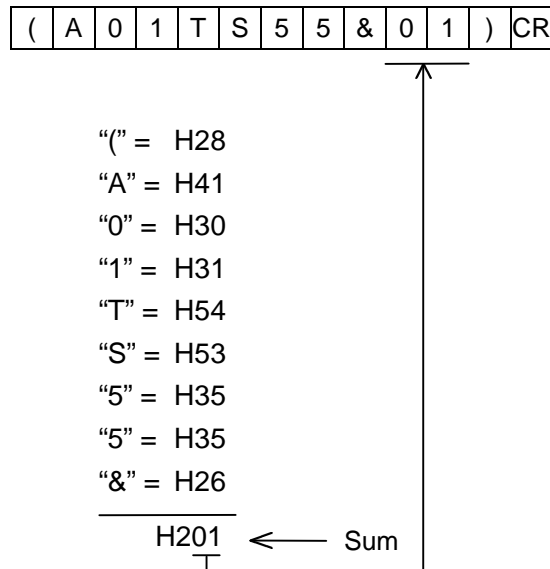

### 5.4

#### Internal process flow

The following diagram illustrates the PLC internal process flow for the Computer Link function.

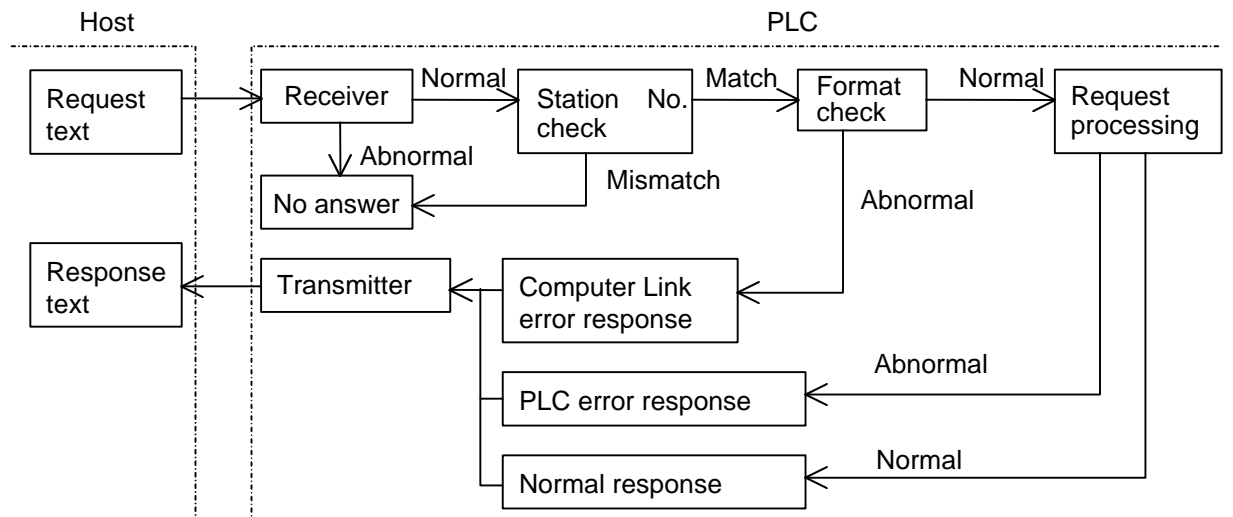

## 6. Commands

## 6.1

List of Commands The following Computer Link commands are available.

Request command	Function name	Description	Response command	Note
--	Computer Link Error Response	Format error has been detected	CE	Response only
--	PLC Error Response	Request command has been rejected by PLC	EE	Response only
TS	Test	Loop back test	TS	
ST	PLC Status Read	Reads PLC status	ST	
ER	PLC Error Status Read	Reads PLC error status	ER	
DR	Data Read	Reads registers/devices data	DR	
DW	Data Write	Writes registers/devices data	ST	
MR	Expanded File Register Read	Reads expanded file register data (from IC memory card)	MR	T3H only
MW	Expanded File Register Write	Writes expanded file register data (into IC memory card)	ST	T3H only
SR	System Information 1 Read	Reads PLC system information 1	SR	
S2	System Information 2 Read	Reads PLC system information 2	S2	
TR	Diagnostic Message Read	Reads user-defined error information	TR	
RT	Clock-calendar Read	Read clock-calendar data	RT	
WT	Clock-calendar Write	Writes clock-calendar data	ST	
EC	PLC Control	Changes PLC operation mode	ST	
BR	System Information Block Read	Reads system information block-by-block	BR	
RB	Program Block Read	Reads program block-by-block	RB	
CR	Comment Block Read	Reads comments block-by-block	CR	T3/T3H only
BW	System Information Block Write	Write system information block-by-block	ST	
WB	Program Block Write	Writes program block-by-block	ST	
CW	Comment Block Write	Write comments block-by-block	ST	T3/T3H only



In the following command explanations, execution examples are the results of using a sample program described in Section 7.2

## 6.Commands

---

### 6.2

#### Computer Link Error Response (CE)

When the PLC detects a parity error, checksum error, format error, etc., the PLC will respond "CE" with the error content.

Request text – any command

Response text

1	2	3	4	5	6	7	8	9	10	11	12	13
(	A	ADR	C	E	Error	&	SUM	)	CR			

  
 Error codes as listed below

Error	Error name	Description
01	Command error	Received command is illegal
02	Format error	Received next format is illegal
03	Checksum error	Checksum mismatch is detected

#### Execution examples Example 1)

```

INPUT DATA   = (A01SS)
SEND DATA    = (A01SS&96)
RECEIVE DATA = (A01CE01&D9)
  
```

Command error (01) ... Illegal command (SS)

#### Example 2)

```

INPUT DATA   = (A01DRRW100,2YW100,3)
SEND DATA    = (A01DRRW100,2YW100,3&BE)
RECEIVE DATA = (A01CE02&DA)
  
```

Format error (02) ... Missing comma between starting register address and number of registers

### 6.3

PLC Error Response (EE) When the PLC receives an unacceptable command, the PLC will respond "EE" with the error content.

Request text – any command

Response text

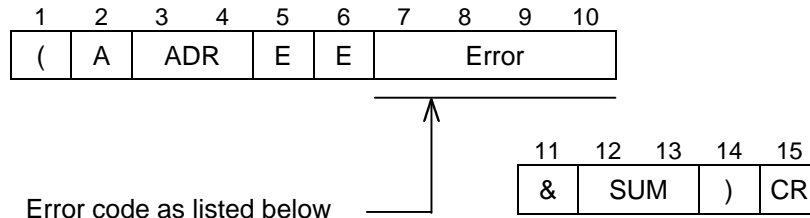

Error	Error name	Description	EE	ER
0010	Power ON	PLC power on		✓
0011	Power OFF	PLC power off		✓
0012	Expansion unit power failure	Expansion unit power failure has been detected	✓	✓
0013	Momentary power interruption	Momentary power interruption has been detected		✓
0014	Momentary power interruption resume	Power has been resumed from momentary interruption		✓
0020	RAM check error	RAM error has been detected		✓
0021	Program BCC error	Program BCC error has been detected		✓
0022	Battery voltage drop	Battery voltage drop has been detected		✓
0023	EEPROM BCC error	BCC error has been detected in built-in EEPROM		✓
0024	EEPROM write error	Data could not be written into EEPROM normally		✓
0026	EEPROM write times warning	EEPROM write operation has exceeded 100,000 times		✓
0030	System RAM error	System RAM error has been detected		✓
0031	System ROM BCC error	BCC error has been detected in system ROM		✓
0033	Clock-calendar check error	Abnormality has been detected in clock-calendar		✓
0034	System illegal interrupt	Illegal interrupt has occurred		✓
0035	Watch dog timer error	Watch dog timer error has occurred		✓
0040	I/O bus error	I/O bus error has been detected	✓	✓
0041	I/O mismatch	Mismatching of mounting I/O and registered I/O has been detected	✓	✓
0042	I/O no answer	No response from registered I/O	✓	✓



## 6.Commands

---

Error	Error name	Description	EE	ER
0043	I/O parity error	I/O parity error has been detected	✓	✓
0044	I/O illegal interrupt	I/O illegal interrupt has occurred		✓
0045	I/O allocation duplicated	Duplicate I/O register allocation has been detected	✓	✓
0046	I/O allocation address over	Excess I/O register allocation has been detected	✓	✓
0051	Communication busy	PLC is busy in processing for other peripheral communications	✓	
0052	Format error	Received text format is illegal	✓	
0060	LP function check error	LP(language processor) function check error has been detected		✓
0063	LP execution time out	LP (language processor) error has been detected		✓
0064	Scan time over	Scan time has exceeded 200 ms		✓
0080	No END instruction	END instruction has not been programmed	✓	✓
0081	Illegal pair instructions	Illegal combination of pair instructions has been detected	✓	✓
0082	Illegal operand	Illegal operand has been detected	✓	✓
0083	Abnormal program	Address control table inconsistency	✓	✓
0084	Jump destination error	Jump destination error has been detected	✓	✓
0086	No subroutine entry	Subroutine entry instruction has not been programmed	✓	✓
0087	No subroutine return	Subroutine return instruction has not been programmed	✓	✓
0088	Subroutine nesting over	Excess (max 6) subroutine nesting has been detected	✓	✓
0089	FOR-NEXT loop nesting over	Excess (max 6) FOR-NEXT loop nesting has been detected	✓	✓
0090	SFC step number error	Duplicate SFC step number has been detected	✓	✓
0091	SFC macro number duplicated	Duplicate SFC macro number has been detected	✓	✓
0092	No SFC macro entry	SFC macro entry has not been found	✓	✓
0094	SFC jump label duplicated	Duplicate SFC jump label has been detected	✓	✓
0095	No SFC jump label	SFC jump label has not been found	✓	✓
0096	SFC program number duplicated	Duplicate SFC program number has been detected	✓	✓
0097	SFC program abnormal	Illegal combination of SFC initial and end steps has been detected	✓	✓
0098	Unsupported function instruction	Unsupported function instruction has been detected	✓	✓

Error	Error name	Description	EE	ER
0106	Password protect	Requested operation is protected by password	✓	
0108	Comment space full	Comment memory is insufficient for the requested command	✓	
0109	Memory type error	Memory capacity type mismatch	✓	
0110	Illegal instruction	Illegal instruction has been detected	✓	✓
0111	Register address over	Excess register address range has been programmed	✓	✓
0112	Boundary error	Boundary error has occurred		✓
0113	Memory full	Program memory is insufficient for the requested command	✓	
0114	Mode mismatch	Received command is invalid in current PLC operation mode	✓	
0115	Register address/size error	Specified register range exceeds the limit	✓	
0117	Memory protect	Writing operation is protected (P-RUN)	✓	
0121	Jump label/subroutine entry duplicated	Duplicate jump label or subroutine entry has been detected	✓	✓
0128	No IC card error	IC memory card is not installed or not allocated for PU slot (MMR setting)		✓
0129	IC memory card BCC error	BCC error has been detected in the IC memory card		✓
0132	IC card type error	IC memory card is used for Program storage		✓
0133	IC memory card capacity mismatch	Memory capacity type mismatch between IC memory card and PLC		✓
0134	IC card write-protect error	IC memory card is set as write-protect		✓

- Errors marked ✓ in EE column are responded with the PLC Error Response (EE).
- Errors marked ✓ in ER column are read out by the PLC Error Status Read command (ER).

### Execution examples Example 1)

```

INPUT DATA    = (A01EC02)
SEND DATA     = (A01EC02&DA)
RECEIVE DATA  = (A01EE0114&40)
    
```

Mode mismatch (0114) ... PLC control command (RUN command) is issued under RUN mode

## 6.Commands

6.4  
 Test (TS) This command tests the communication between the host computer and the PLC. When the PLC receives the Test command (TS), it returns the same text to the host computer.

Request text

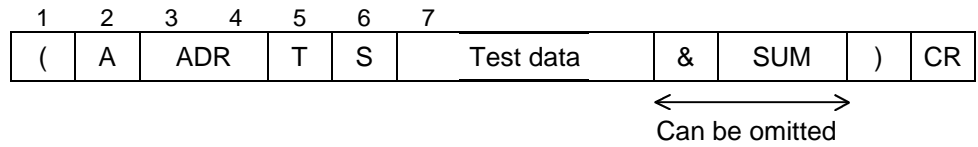

Response text

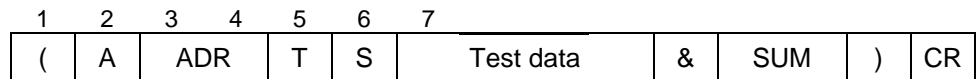

"CE" or "EE" is returned when communication error has occurred.

- The maximum size of the Test data field is 244 bytes.
- Any ASCII code, except for the following characters, can be used.

"("	H28	}	Error (CE) is returned
"&"	H26		
")"	H29		
CR	H0D		
" "	H20	—	Ignored

Execution examples Example 1)

```

INPUT DATA   = (A01TS123456789)
SEND DATA    = (A01TS123456789&74)
RECEIVE DATA = (A01TS123456789&74)
  
```

Example 2)

```

INPUT DATA   = (A01TS   12345)
SEND DATA    = (A01TS   12345&16)
RECEIVE DATA = (A01TS12345&96)
  
```

Space codes in the Test data are ignored

6.5

PLC Status Read (ST) This command reads the PLC operation status.

Request text

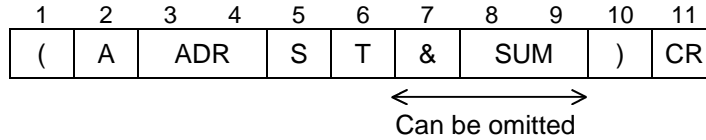

Response text

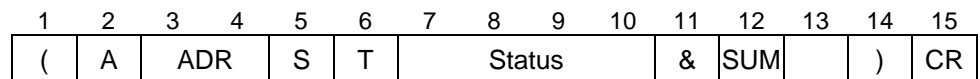

"CE" or "EE" is returned when communication error has occurred.

- The Status field shows the PLC operation status as follows.

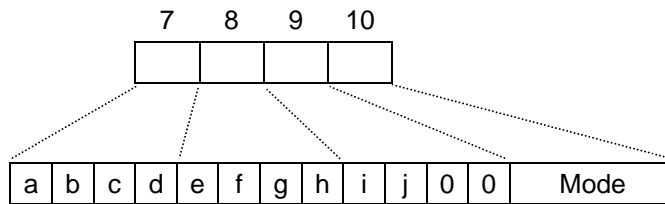

Mode = PLC mode

- 1: HALT
- 2: RUN
- 3: RUN-F
- 4: HOLD
- 6: ERROR
- 9: D-HALT
- 10: D-RUN
- 11: D-STOP
- 13: S-HALT
- 14: S-RUN
- 15: S-STOP

- a = 1: Battery alarm
- b = 1: TOSLINE-S20 error
- c = 1: TOSLINE-F10 error
- d = 1: Computer Link error
- e = 1: Constant scan time over
- f = 1: Diagnostic display request
- g = 1: Under program down-loading
- h = 1: Memory protect (P-RUN)
- i = 1: I/O inhibited (mode=13 to 15)
- j = 1: Bit pattern check error (f=1)

Execution examples Example 1)

INPUT DATA = (A01ST)  
 SEND DATA = (A01ST&97)  
 RECEIVE DATA = (A01ST0001&58)

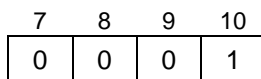

└─── PLC mode = HALT

## 6.Commands

---

### Example 2)

INPUT DATA = (A01ST)  
SEND DATA = (A01ST&97)  
RECEIVE DATA = (A01ST0102&5A)

7	8	9	10
0	1	0	2

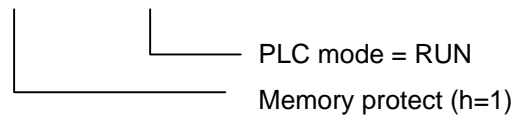

### Example 3)

INPUT DATA = (A01ST)  
SEND DATA = (A01ST&97)  
RECEIVE DATA = (A01ST8004&63)

7	8	9	10
8	0	0	4

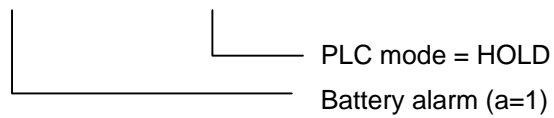

### 6.6

#### PLC Error Status Read (ER)

If an error occurs in the PLC, this command can be used to read the error cause and determine why the PLC shut down.

Request text

1	2	3	4	5	6	7	8	9	10	11
(	A	ADR	E	R	&	SUM	)	CR		

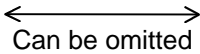

Response text

1	2	3	4	5	6	7	8	9	10	11	12	13	14	15	
(	A	ADR	E	R	Error					&	SUM	)	CR		

"CE" or "EE" is returned when communication error occurs

- The Error field shows the latest error status stored in the PLC's event history table.
- Refer to Section 6.3 PLC Error Response (EE) for the contents of Error.

#### Execution examples Example 1)

```

INPUT DATA   = (A01ER)
SEND DATA    = (A01ER&87)
RECEIVE DATA = (A01ER0080&4F)
    
```

Error code = 0080 ... No END instruction

**NOTE**  

Even if the error has been reset, "ER" command reads the latest error status stored in PLC's event history table.

## 6.Commands

6.7  
Data Read (DR) This command is used to read the data of registers and/or devices consecutively. Multiple types of registers/devices can be specified at a time.

Request text

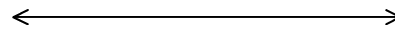
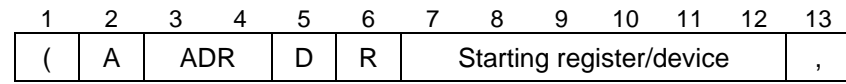

Variable length

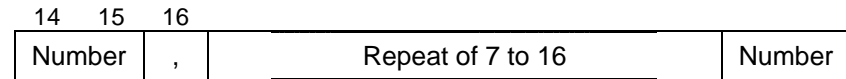

Variable length

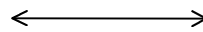
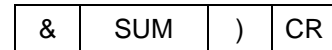

Can be omitted

Response text

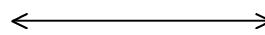
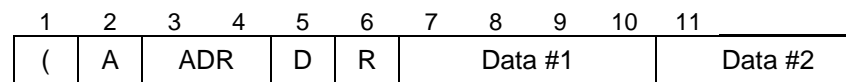

4 bytes fixed

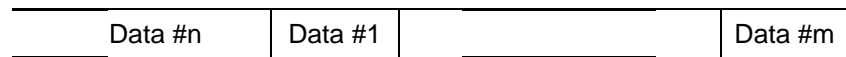

Only for Timer/Counter read (see Note)

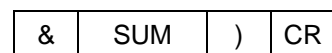

"CE" or "EE" is returned when communication error occurs

- This command reads the data of specified number of registers/devices starting with specified address.
- Multiple types of registers/devices can be specified at a time.
- Total up to 32 register/device data can be read at a time.
- Upper 0 can be omitted in the starting register/device and the number fields. (E.g., R0009 → R9, 05 → 5)
- If the content of a number field is 1, the number field can be omitted.
- The starting register/device and the number fields are separated by "," (comma).
- In the response text, the data are packed in the specified order.
- Each data is expressed in 4 digits hexadecimal format. For a device, "0000" and "0001" represent OFF and ON respectively.



(1) In case of Timer/Counter register read, the device data (2 bytes each) corresponding to the register are added.  
 If the Timer/Counter has been time-up/count-up, the device data is "01". Otherwise, it is "00".

(2) The types of register/device which can be specified are as follows.

Register:

XW, YW, SW, LW, RW, W, T, C, D and F  
 (IW, OW, I, J and K cannot be specified)

Device:

X, Y, S, L, R and Z  
 (T., C., I and O cannot be specified)

#### Execution examples Example 1)

```
INPUT DATA   = (A01DRRW1, 3)
SEND DATA    = (A01DRRW1, 3&BF)
RECEIVE DATA = (A01DR1EB922F122A8&2F)
```

Three registers starting with RW001

RW001 = H1EB9, RW002 = H22F1, RW003 = H22A8

#### Example 2)

```
INPUT DATA   = (A01DRRW4)
SEND DATA    = (A01DRRW4&63)
RECEIVE DATA = (A01DR004E&5F)
```

RW004 (Number field omitted)

RW004=H004E

#### Example 3)

```
INPUT DATA   = (A01DRYW1, 3, R50, 5)
SEND DATA    = (A01DRYW1, 3, R50, 5&0A)
RECEIVE DATA = (A01DR0000001B8AAA00010001000000000001&D7)
```

YW001 to YW003 and R0050 to R0054

YW001 = H0000, YW002 = H001B, YW003 = H8AAA

R0050 = ON, R0051 = ON, R0052 = OFF, R0053 = OFF, R0054 = ON

#### Example 4)

```
INPUT DATA   = (A01DRC0)
SEND DATA    = (A01DRC0&F9)
RECEIVE DATA = (A01DR000301&AA)
```

C000 (Counter register)

C000 = 0003 ... present value

C.000 = 01 (on) ... count - up



## 6.Commands

6.8  
Data Write (DW) This command is used to write the data into the PLC's registers and/or devices consecutively. Multiple types of registers/devices can be specified at a time.

Request text

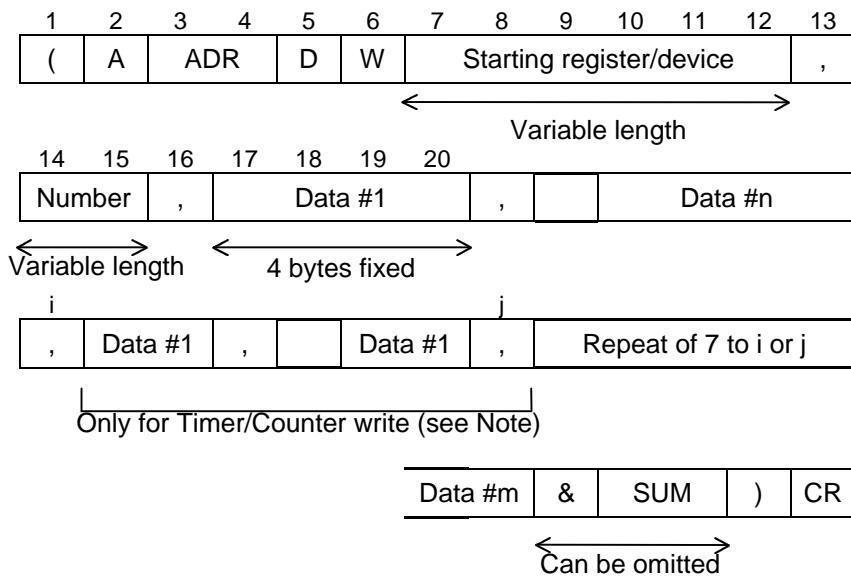

Response text

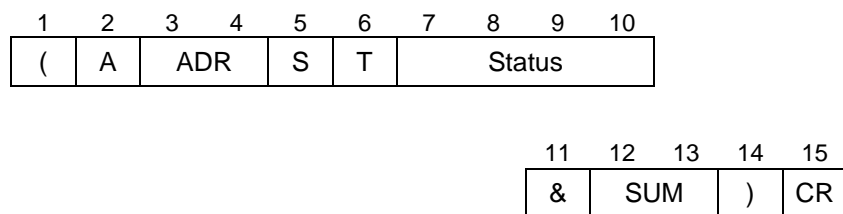

"CE" or "EE" is returned when communication error occurs

- This command writes the data into the specified number of registers/devices starting with specified address.
- Multiple types of registers/devices can be specified at a time.
- Total up to 32 register/device data can be written at a time.
- Upper 0 can be omitted in the starting register/device and the number fields. (E.g., R0009 → R9, 05 → 5)
- The starting register/device, the number and each data fields are separated by "," (comma).
- Each data is expressed in 4 digits hexadecimal format. For a device, "0000" and "0001" represent OFF and ON respectively.
- When the processing is completed normally, the PLC Status Read (ST) response is returned.



- (1) In case of Timer/Counter register write, the device data (2 bytes each) corresponding to the register should be added. If the Timer/Counter device is set to ON, it should be "01". Otherwise, it should be "00".  
 (2) The types of register/device which can be specified are as follows.

Register:

XW, YW, SW, LW, RW, W, T, C, D and F  
 (IW, OW, I, J and K cannot be specified)

Device:

X, Y, S, L, R and Z  
 (T., C., I and O cannot be specified)

### Execution examples Example 1)

```
INPUT DATA    = (A01DWRW1, 3, FFFF, 5A5A, 0011)
SEND DATA     = (A01DWRW1, 3, FFFF, 5A5A, 0011&0E)
RECEIVE DATA  = (A01ST0004&5B)
```

Writes HFFFF, H5A5A and H0011 into RW001, RW002 and RW003 respectively

```
INPUT DATA    = (A01DRRW1, 3)
SEND DATA     = (A01DRRW1, 3&BF)
RECEIVE DATA  = (A01DRFFFF5A5A0011&4C)
```

Confirmation by DR command

### Example 2)

```
INPUT DATA    =
(A01DWD100, 2, FFFF, EFFF, R20, 5, 0001, 0001, 0000, 0000, 0001)
SEND DATA     =
(A01DWD100, 2, FFFF, EFFF, R20, 5, 0001, 0001, 0000, 0000, 0001&25)
RECEIVE DATA  = (A01ST0004&5B)
```

Writes HFFFF and HEFFF into D100 and D101, writes ON, ON, OFF, OFF, ON into R0020 to R0024 respectively

```
INPUT DATA    = (A01DRR20, 5)
SEND DATA     = (A01DRR20, 5&9B)
RECEIVE DATA  = (A01DR00010001000000000001&49)
```

Confirmation by DR command (R0020 to R0024)

## 6.Commands

6.9

Expanded file register  
data read (MR)

This command is used to read the PLC's expanded file register data store in the IC memory card.

There are two types of data storage format for the IC memory card. They are 8 k words per bank and 64 k words per bank. (Refer to XFER instruction)

Note that the computer link commands for these formats are slightly different.

**NOTE**



T3H version 1.1 or  
later only

Request text

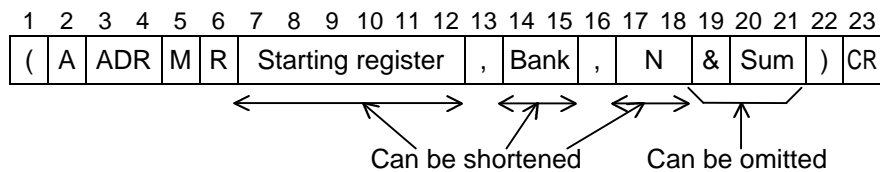

Starting register:

For 8 k words per bank -----F0000 to F8191 ← Upper case F

For 64 k words per bank -----f0000 to f65535 (bank 1)  
f0000 to f57343 (bank 2) ] ← Lower case f

Bank: For 8 k words per bank-----1 to 15

For 64 k words per bank ---1 to 2

N: Number of registers to be read---- 1 to 61 (61 words max.)

Response text

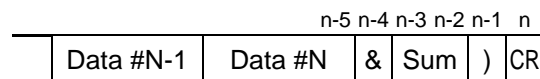
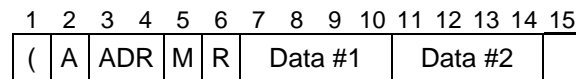

"CE" or "EE" is returned when communication error occurs



## 6.Commands

6.11  
System Information 1  
Read (SR) This command is used to read the PLC's system information page 1 (Used steps, Program I.D., Program comment, Memory type, PLC type and PLC OS version.)

Request text

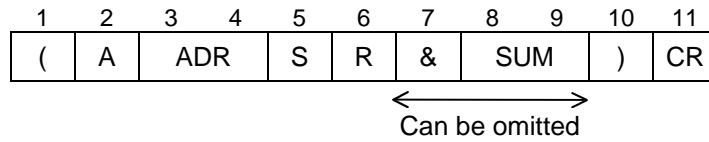

Response text

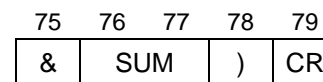
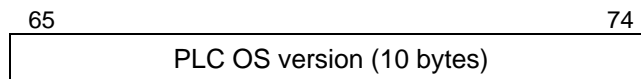
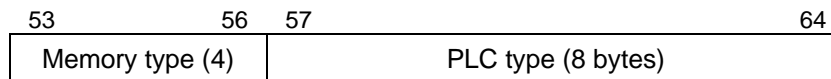
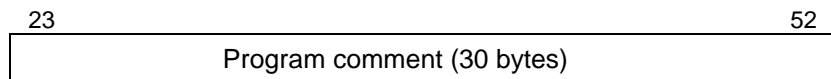
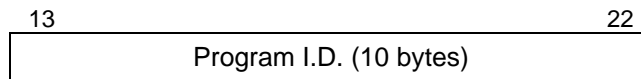
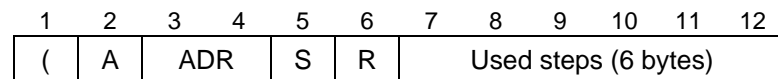

“CE” or “EE” is returned when communication error occurs

- Used steps: Steps of user program used (Decimal format)

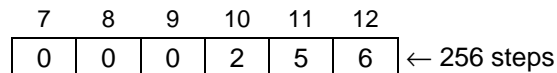

- Program I.D.: Registered name of user program
- Program comment: Registered comment for user program

- Memory type: Memory capacity type of the PLC

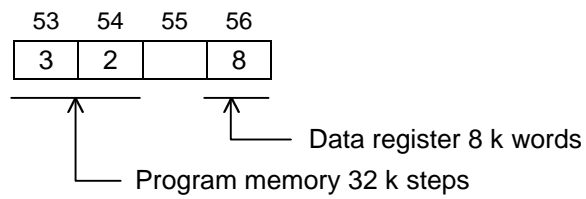

- PLC type: PLC model
- PLC OS version: PLC system version number



For detailed meanings of each item, see your PLC's User's Manual.

#### Execution examples Example 1)

```

INPUT DATA    = (A01SR)
SEND DATA     = (A01SR&95)
RECEIVE DATA =
(A01SR000114SAMPLE001 T3 Sample Program 4/14/93 32 8 T3 Ver. 1.31
&B8)

```

```

Used steps = 114 steps
Program I.D. = SAMPLE001
Program comment = T3 Sample Program 4/14/93
Memory type = 32 k steps/8 k words
PLC type = T3
PLC OS version = Ver. 1.31

```

## 6.Commands

### 6.12 System Information 2 Read (S2)

This command is used to read the PLC's system information page 2 (Program size, Sampling buffer size, Retentive memory area, Constant scan interval, Subprogram execution time limit, Timer interrupt interval and Computer Link transmission mode settings).

Request text

1	2	3	4	5	6	7	8	9	10	11
(	A	ADR	S	2	&	SUM	)	CR		

←—————→  
Can be omitted

Response text

1	2	3	4	5	6	7	8	9	10
(	A	ADR	S	2	P. size	S.buffer			

11	12	13	14	15	16	17	18	19	20	21	22
Retentive (RW)				Retentive (T)				Retentive (C)			

23	24	25	26	27	28	29	30	31	32	33	34
Retentive (D)				Constant scan				Sub. time limit			

35	36	37	38	39	40	41	42	43	44	45	46
Timer interrupt				Stn No.		Baud rate					

47	48	49	50	51	52	53	54	55	56	57
Parity		Data bit		Stop bit		&	SUM	)	CR	

“CE” or “EE” is returned when communication error occurs

- P. size: Program size setting (Decimal)

7	8
1	6

← 16 k steps

- S. buffer: Sampling buffer size setting (Decimal)

9	10
0	8

← 8 k words

- Retentive: Retentive memory area settings for RW, T, C and D (Decimal)

11	12	13	14
0	1	2	8

← RW000 to RW128 has been specified as retentive memory

- Constant scan: Constant scan interval setting (Decimal)

27	28	29	30	
0	1	0	0	← 100 msec. "0000" is floating scan

- Sub. time limit: Time limit for subprogram execution (Decimal)

31	32	33	34	
0	0	0	8	← 8 msec

- Timer interrupt: Timer interrupt interval setting (Decimal)

35	36	37	38	
0	5	0	0	← 500 msec. "0000" is no execution

- Stn No.: Station number setting for Computer Link (Decimal)

39	40	
2	1	← Station 21

- Baud rate: Baud rate setting for Computer Link (Decimal)

41	42	43	44	45	46	
		9	6	0	0	← 9600 bps
		↑		Space codes (H20) are inserted into upper 0		

- Parity: Parity setting for Computer Link

47	48	
		← 00: Non 01: Odd 02: Even

- Data bit: Data bit length setting for Computer Link

49	50	
		← 07: 7 bits 08: 8 bits

- Stop bit: Stop bit length setting for Computer Link

51	52	
		← 01: 1 bit 02: 2 bits

**NOTE**  
▼△▼

For detailed meanings of each item, see your PLC's User's Manual.



## 6.Commands

---

### Execution examples Example 1)

INPUT DATA = (A01S2)  
SEND DATA = (A01S2&75)  
RECEIVE DATA =  
(A01S23202012700310031051102000000100001 9600000801&31)

Program size setting = 32 k steps  
Sampling buffer size setting = 2 k words  
Retentive memory area (RW) = RW000 to RW127  
Retentive memory area (T) = T000 to T031  
Retentive memory area (C) = C000 to C031  
Retentive memory area (D) = D0000 to D0511  
Constant scan interval = 200 msec.  
Subprogram execution time limit = Not applicable (constant scan)  
Timer interrupt interval = 1000 msec.  
Station number = 1  
Baud rate = 9600 bps  
Parity = Non  
Data bit length = 8 bits  
Stop bit length = 1 bit

6.13 Diagnostic Message Read (TR) This command is used to read the user-defined diagnostic message. (the first registered message)

Request text

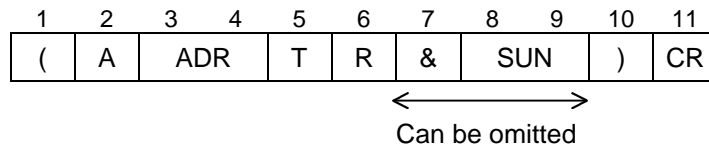

Response text

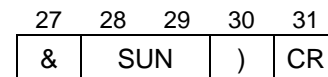
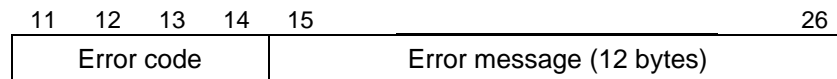
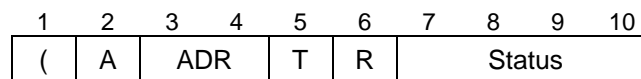

"CE" or "EE" is returned when communication error occurs

- When the Diagnostic display instruction (FUN 150) is executed in the PLC user program, user-defined error code and error message are registered in PLC internal table. This command read the first registered error code and error message from the table.
- Error code are expressed by hexadecimal format.
- If no error code has been registered, "0000" is returned as Error code. And in this case, the Error message field (12 bytes) is not added.
- Refer to Section 6.5 PLC Status Read (ST) for contents of the Status field.

Execution examples Example 1)

```

INPUT DATA   = (A01TR)
SEND DATA    = (A01TR&96)
RECEIVE DATA = (A01TR00010000&17)
  
```

```

PLC status = H0001 (HALT)
Error code = H0000 (no error code registered)
  
```

Example 2)

```

INPUT DATA   = (A01TR)
SEND DATA    = (A01TR&96)
RECEIVE DATA = (A01TR00020002LIMIT OVER &35)
  
```

```

PLC status = H0002 (RUN)
Error code = H0002
Error message = LIMIT OVER
  
```

## 6.Commands

---

### Example 3)

INPUT DATA = (A01TR)  
SEND DATA = (A01TR&96)  
RECEIVE DATA = (A01TR00010002 &19)

PLC status = H0001 (HALT)

Error code = H0002

Error message = (Blank) ← Error message has not been registered with Error code 2

### 6.14 Clock-calendar Read (RT)

This command is used read the PLC's built-in clock-calendar data.

Request text

1	2	3	4	5	6	7	8	9	10	11
(	A	ADR	R	T	&	SUM	)	CR		

Can be omitted

Response text

1	2	3	4	5	6	7	8	9	10
(	A	ADR	R	T	Status				

11	12	13	14	15	16	17	18	19	20	21	22
Year	Month	Day	Hour	Minute	Second						

23	24	25	26	27
&	SUN	)	CR	

"CE" or "EE" is returned when communication error occurs

- Clock-calendar data are expressed by 2 digits decimal format.
- Refer to Section 6.5 PLC Status Read (ST) for contents of the Status field.

#### Execution examples Example 1)

```

INPUT DATA   = (A01RT)
SEND DATA    = (A01RT&96)
RECEIVE DATA = (A01RT0001911004155911&BC)
  
```

```

October, 4, 1991 15:59:11
PLC status = H0001 (HALT)
  
```



6.16  
 PLC Control (EC) This command is used to control the PLC operation mode.

Request text

1	2	3	4	5	6	7	8	9	10	11	12	13
(	A	ADR	E	C	Mode	&	SUM	)	CR			

←—————→  
Can be omitted

Response text

1	2	3	4	5	6	7	8	9	10
(	A	ADR	S	T	Status				

11	12	13	14	15
&	SUM	)	CR	

"CE" or "EE" is returned when communication error occurs

- The Mode field of the request text specifies the PLC mode to be changed. (2 bytes)

01: HALT  
 02: RUN  
 03: RUN-F  
 04: HOLD  
 05: DEBUG  
 06: Error reset  
 07: HOLD reset

- The PLC status in the response text shows PLC mode after changed as par request.

**NOTE**



- (1) For detailed information of PLC mode, see your PLC's User's Manual.  
 (2) This command is not effective when the PLC operation mode switch is in HALT. (except Error reset)

## 6.Commands

---

### Execution examples Example 1)

```
INPUT DATA    = (A01EC02)
SEND DATA     = (A01EC02&DA)
RECEIVE DATA  = (A01ST0002&59)
```

Changing HALT to RUN - Normal complete

### Example 2)

```
INPUT DATA    = (A01EC04)
SEND DATA     = (A01EC04&DC)
RECEIVE DATA  = (A01ST0004&5B)
```

Changing RUN to HOLD - Normal complete

### Example 3)

```
INPUT DATA    = (A01EC02)
SEND DATA     = (A01EC02&DA)
RECEIVE DATA  = (A01EE0114&40)
```

Command RUN during RUN mode - Mode mismatch (0114)

### Example 4)

```
INPUT DATA    = (A01ER)
SEND DATA     = (A01ER&87)
RECEIVE DATA  = (A01ER0041&4C)
```

PLC Error Status Read - I/O mismatch (0041)

```
INPUT DATA    = (A01EC06)
SEND DATA     = (A01EC06&DE)
RECEIVE DATA  = (A01ST0001&58)
```

Command Error reset - Normal complete

### Example 5)

```
INPUT DATA    = (A01EC08)
SEND DATA     = (A01EC08&E0)
RECEIVE DATA  = (A01CE02&DA)
```

Format error (02) Illegal code (08) was specified

6.17  
System Information  
Block Read (BR)

This command is used to read the system information from the PLC block-by-block. (Program up-loading)

Request text

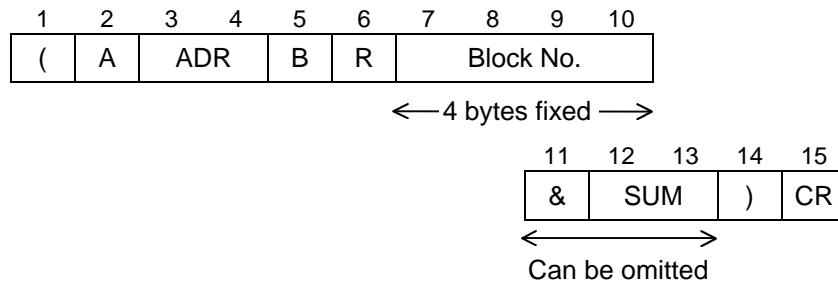

Response text

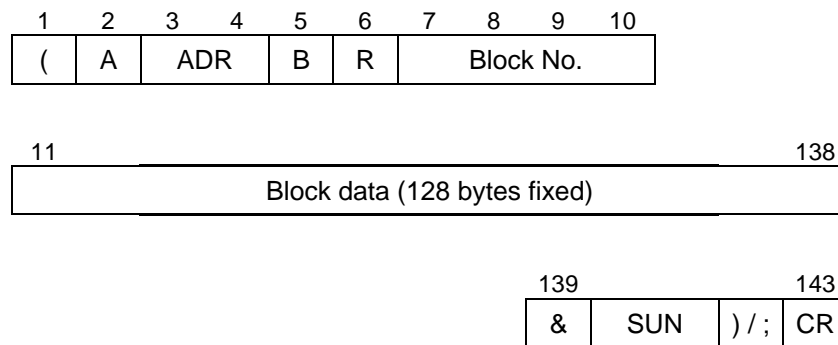

"CE" or "EE" is returned when communication error occurs

- The PLC's system information memory contents are read by specifying the block number.
- The size of one block is 128 bytes.
- Block number is 0000 to 0015 (16 blocks). This command should be used from block 0000 through 0015 consecutively.
- The end code ";" (H3B) is used for block 0000 to 0014 to show a halfway block. And normal end code ")" (H29) is used for block 0015 to show the final block.





6.18 Program Block Read (RB) This command is used to read the user program contents from the PLC block-by-block. (Program up-loading)

Request text

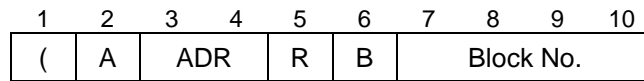

← 4 bytes fixed →

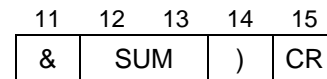

← Can be omitted →

Response text

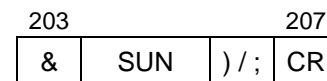
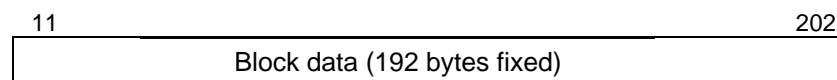
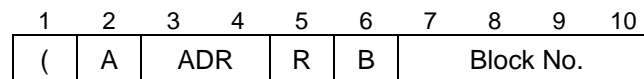

"CE" or "EE" is returned when communication error occurs

- The PLC's user program memory contents are read by specifying the block number.
- The size of one block is 192 bytes.
- Block number is 0000 to 1007 (1008 blocks). This command should be started with block 0000 and in order.
- The end code ")" (H29) is returned if the block contains the program end. Otherwise, ";" (H3B) is returned.



6.19

Comment Block Read (CR)

This command is used to read the register/device comments (tags and comments) stored in PLC block-by-block. (Program up-loading)

NOTE



T3/T3H only

Request text

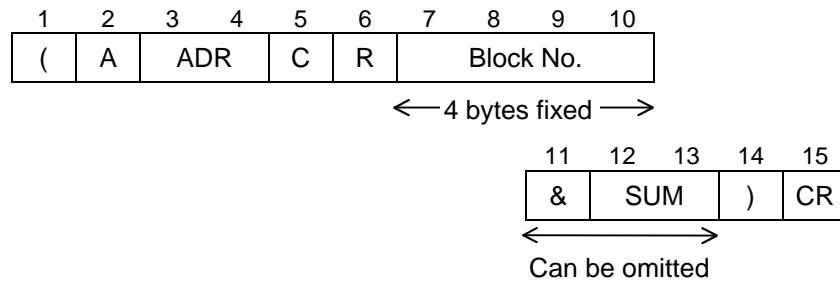

Response text

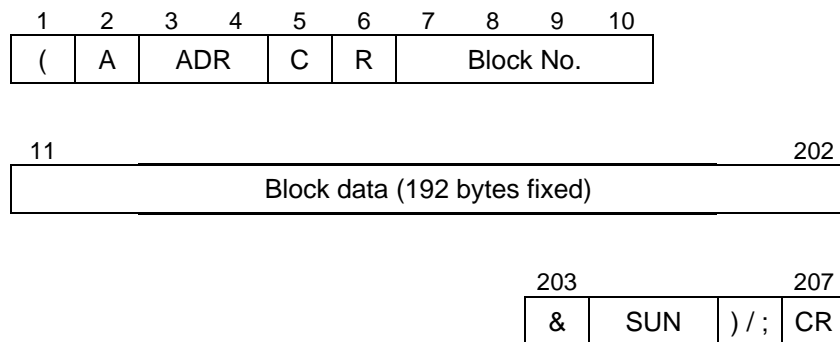

"CE" or "EE" is returned when communication error occurs

- The PLC's comment memory contents are read by specifying the block number.
- The size of one block is 192 bytes.
- Block number is 0000 to 0991 (992 blocks maximum if 31 k steps are assigned for comments).
- The end code ")" (H29) is returned if the specified block is final. Otherwise, ";" (H3B) is returned.
- If no comment is stored in the specified block, the Block data field is not added in the response text.

NOTE



The T1 and T2 series cannot store comments in it's memory. If this command is executed for the T1/T2, the Computer Link Error Response (CE) is returned.

## 6.Commands

---

### Execution examples Example 1)

```
INPUT DATA    = (A01CR0000)
SEND DATA     = (A01CR0000&45)
RECEIVE DATA  =
(A01CR0000000000000000400000040000000000040000000000040000000000
040000000000040000000000040000000000040000000000040000000000
040000000000040000000000040000000000040000000000040000000000
04000000000004000000000&85;
```

```
INPUT DATA    = (A01CR0001)
SEND DATA     = (A01CR0001&46)
RECEIVE DATA  =
(A01CR0001000400000000000040000000000040000000000000073773120
205B8B4E93AE83588343836283602020202020202020200001000073773220
205C92E28E7E83588343836283602020202020202020200002000073773320
205D8BD98B7D92E28E7E20&45;
```

```
INPUT DATA    = (A01CR0002)
SEND DATA     = (A01CR0002&47)
RECEIVE DATA  =
(A01CR0002202020202020202020202020200003000073773420205E92CA8FED
92E28E7E202020202020202020202020200000000000000000000000000000
00000000000000000000000000000000000000000000000000000000000000
000000000000000000000000&86)
```

The comment block read operation is completed normally.  
(Number of blocks is 3)

### Example 2)

```
INPUT DATA    = (A01CR0000)
SEND DATA     = (A01CR0000&45)
RECEIVE DATA  = (A01CE01&D9)
```

The Comment Block Read command (CR) is sent for T2. Command error (01)

6.20  
System Information  
Block Write (BW)

This command is used to write the system information data obtained by using the "BR" command into PLC memory block-by-block. (Program down-loading)

Request text

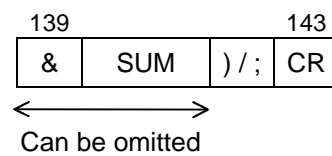
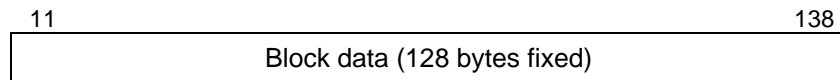
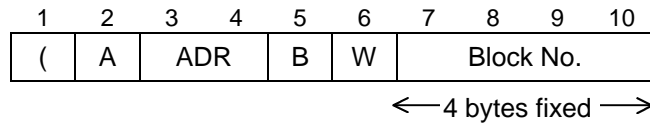

Response text

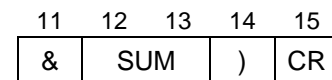
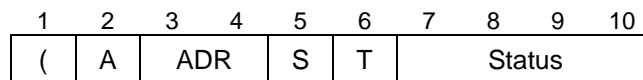

"CE" or "EE" is returned when communication error occurs

- The system information contents are written into PLC memory by specifying the block number.
- The size of one block is 128 bytes.
- Block number is 0000 to 0015 (16 blocks). This command should be used from block 0000 through 0015 consecutively.
- The end code ";" (H3B) must be used for block 0000 to 0014 to show a halfway block. And normal end code ")" (H29) must be used for block 0015 to show to the final block.

## 6.Commands

6.21  
 Program Block Write (WB) This command is used to write the user program data obtained by using the "RB" command into PLC memory block-by-block. (Program down-loading)

Request text

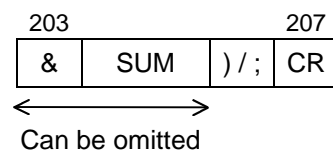
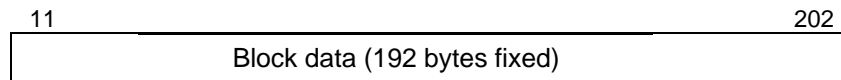
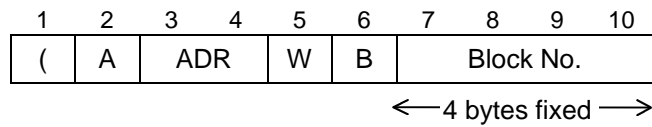

Response text

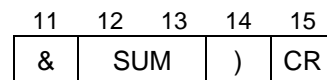
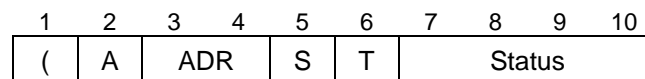

"CE" or "EE" is returned when communication error occurs

- The user program contents are written into PLC memory by specifying the block number.
- The size of one block is 192 bytes.
- Block number is 0000 to 1007 (1008 blocks). This command should be started with block 0000 and in order,
- The end code ";" (H3B) must be used for halfway blocks. And normal end code ")" (H29) must be used for the final block.

6.22  
Comment Block Write  
(CW)

This command is used to write the register/device comments (tags and comments) obtained by using the "CR" command into PLC memory block-by-block. (Program down-loading)

NOTE



T3/T3H only

Request text

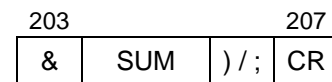
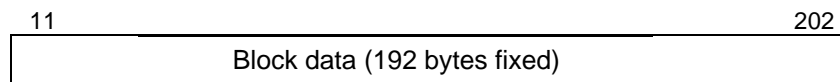
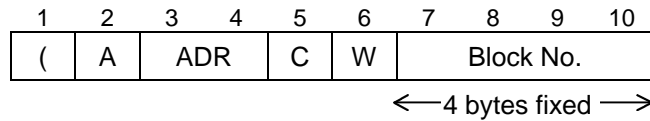

←————→  
Can be omitted

Response text

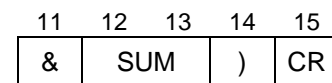
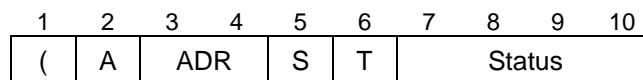

"CE" or "EE" is returned when communication error occurs

- The register/device comments are written into PLC memory by specifying the block number.
- The size of one block is 192 bytes.
- Block number is 0000 to 0991 (992 blocks maximum if 31 k steps are assigned for comments).
- This command should be started with block 0000 and in order.
- The end code ";" (H3B) must be used for halfway blocks. And normal end code ")" (H29) must be used for the final block.

NOTE



If this command is executed for the T1/T2, the Computer Link Error Response (CE) is returned.



## 7. Sample communication programs

---

### 7. Sample communication programs

This section provides four sample programs for the host computer. These programs have been written in IBM® BASIC language. The transmission parameters have been set as 9600 baud, non parity, 8 bits data length and 1 stop bit, in the sample programs.

#### 7.1

**Simple send/receive test** The program can be used to test the communication between the PLC and the host computer.

```
100 '*****
110 '*          COMPUTER LINK TEST 0
120 '*          (SEND AND RECEIVE TEST)
140 '*****
150 '***** INITIALIZE *****
160 SCREEN 0:KEY OFF:CLS
170 DEFINT A-Z
180 '***** COMMUNICATION INITIALIZE *****
190 OPEN "COM1:9600,N,8,1" AS #1
200 '***** KEY INPUT *****
210 TEXT$="":DAT$=""
220 PRINT "INPUT DATA  = ";
230 IF DAT$=CHR$(&HD) THEN 290
240   DAT$=INKEY$:PRINT DAT$;
250   TEXT$=TEXT$+DAT$
260 GOTO 230
270 '
280 '***** DATA SEND *****
290 PRINT "SEND DATA  = ";
300 PRINT TEXT$;
310 PRINT #1,TEXT$;
320 '***** RECEIVE DATA *****
330 RD$="":A$="":B$="":TIME$="00:00:00"
340 PRINT "RECEIVE DATA = ";
350 IF B$=CHR$(&HD) THEN 430
360   IF TIME$="00:00:03" THEN PRINT "TIMEOUT ERROR":END
370   IF LOC(1)=0 THEN 420
380     A$=INPUT$(LOC(1),#1)
390     RD$=RD$+A$
400     B$=RIGHT$(A$,1)
410     GOTO 370
420 GOTO 350
430 PRINT RD$;
440 PRINT
450 GOTO 210
```

## 7. Sample communication programs

### 7.2

**Send/receive test with sum check** The program can also be used to test the communication between the PLC and the host computer. The sum check routine has been added to the sample program described in Section 7.1.

```
100 '*****
110 '*          COMPUTER LINK TEST 1
120 '*          (SEND AND RECEIVE TEST)
140 '*****
150 '***** INITIALIZE *****
160 SCREEN 0:KEY OFF:CLS
170 DEFINT A-Z
180 ON ERROR GOTO 700
190 '***** COMMUNICATION INITIALIZE *****
200 OPEN "COM1:9600,N,8,1" AS #1
210 '***** KEY INPUT *****
220 TEXT$="":DAT$="":PRINT "INPUT DATA  = ";
230 WHILE DAT$<>CHR$(&HD)
240   DAT$=INKEY$:PRINT DAT$;
250   TEXT$=TEXT$+DAT$
260 WEND
270 '***** CHECK SUM MAKE *****
280 SUM=0:I=1
290 L=LEN(TEXT$):IF L<=5 THEN PRINT "-- INPUT ERROR --":GOTO 220
300 SD$=LEFT$(TEXT$(L-2)):SD$=SD$+"&"
310 WHILE I<=L-1
320   A$=MID$(SD$,I,1)
330   SUM=SUM+ASC(A$)
340   I=I+1
350 WEND
360 SUM$=HEX$(SUM)
370 SUM$=RIGHT$(("0"+SUM$),2)
380 SD$=SD$+SUM$+"")+CHR$(&HD)
390 '***** DATA SEND *****
400 PRINT "SEND DATA  = ";
410 PRINT SD$;
420 PRINT #1,SD$;
430 '***** RECEIVE DATA *****
440 RD$="":A$="":B$="":TIME$="00:00:00"
450 PRINT "RECEIVE DATA = ";
460 WHILE B$<> CHR$(&HD)
470   IF TIME$="00:00:03" THEN PRINT "TIMEOUT ERROR":END
480   WHILE LOC(1)<>0
490     A$=INPUT$(LOC(1),#1)
500     RD$=RD$+A$
510     B$=RIGHT$(A$,1)
520   WEND
530 WEND
540 PRINT RDS;
550 PRINT
560 '*****CHECK SUM CHECK *****
570 SUM=0: I=1:A$=""
580 L=LEN (RD$)
590 WHILE A$<>"&"
600   A$=MID$(RD$,I,1)
610   SUM=SUM+ASC(A$)
620   I=I+1
630 WEND
640 SUM$=HEX$(SUM)
650 SUM$=RIGHT$(("0"+SUM$),2)
660 TESTSUM$=LEFT$(RIGHT$(RD$,4),2)
670 IF SUM$<>TESTSUM$ THEN PRINT "-- SUM ERROR --":END
680 GOTO 220
690 '***** ERROR TASK *****
700 PRINT "ERROR ":CLOSE #1: RESUME 100
```

## 7. Sample communication programs

### 7.3

Program up-loading This program can be used to read the user program (including the system information) from the PLC, and save it into a disk file.

```
1000 '*****
1010 '*      COMPUTER LINK TEST 2
1020 '*      (BLOCK READ TEST)
1040 '*****
1050 '*****INITIALIZE*****
1060 CLS:DEFINT A-Z
1070 BLK=0:B$="":RD$=""
1080 INPUT "SAVE FILE =      ";NA$
1090 OPEN NA$ FOR OUTPUT AS #2
1110 '**** COMMUNICATION INTIALIZE ****
1120 OPEN "COM1:9600,N,8,1" AS #1
1140 '***** STATION NO SET *****
1150 INPUT "INPUT STATION NO ";A%
1160 STN%=A%+100
1170 IF STN% > 132 GOTO 1600
1180 STN$=RIGHT$(STR$(STN%),2)
1200 '*****DATA SET*****
1210 B$="":RD$="":BL=BLK+10000
1220 BLK$=RIGHT$(STR$(BL),4)
1230 SD$="(A"+STN$+"BR"+BLK$+)" "+CHR$(&HD)
1240 GOTO 1290
1250 B$="":RD$"":BL=BLK+10000
1260 BLK$=RIGHT$(STR$(BL),4)
1270 SD$="(A"+STN$+"RB"+BLK$+)" "+CHR$(&HD)
1290 '*****DATA SEND*****
1300 PRINT "SEND DATA      = "SD$
1310 PRINT #1,SD$;
1330 '*****DATA RECEIVE*****
1340 RD$="":BS="":TIME$"00:00:00"
1350 PRINT "RECEIVE DATA  = ";
1360 IF RIGHT$(B$,1)=CHR$(&HD) THEN 1440
1370 IF TIME$="00:00:03" THEN PRINT "TIMEOUT":BEEP:PRINT:GOTO 1610
1380   IF LOC (1)=0 THEN 1360
1390     B$=INPUT$(LOC(1),#1)
1400     RD$=RD$+B$
1410     GOTO 1360
1430 '***** DATA SAVE *****
1440 PRINT RD$
1450 IF LEN(RD$)<>143 THEN GOTO 1500
1460 SV$=MID$(RD$,11,128)
1470 WRITE #2,SV$
1480 BLK=BLK+1
1490 IF RIGHT$(RD$,2)=CHR$(&H29)+CHR$(&HD) THEN BLK=0:GOTO 1250 ELSE 1210
1500 IF LEN(RD$)<>207 GOTO 1580
1510 SV$=MID$(RD$,11,192)
1520 WRITE #2,SV$
1530 BLK=BLK+1
1540 IF RIGHT$(RD$,2)=CHR$(&H29)+CHR$(&HD) GOTO 1580
1550 GOTO 1250
1570 '*****COMPLETE*****
1580 CLOSE:PRINT "COMPLETE":GOTO 1630
1590 END
1600 PRINT "STATION NO ERROR"
1610 INPUT "RETRY Y/N      ";A$
1620 IF A$="Y" GOTO 1140 ELSE END
1630 INPUT "TEST CONTINUE Y/N";A$
1640 IF A$="Y" GOTO 1650 ELSE END
1650 CLOSE COM1:GOTO 1060
```

## 7.4

Program down-loading This program can be used to load the user program (including the system information) into the PLC. (Disk file → PLC)

```

1000 '*****
1010 '*      COMPUTER LINK TEST 3
1020 '*      (BLOCK WRITE TEST)
1040 '*****
1050 '*****INITIALIZE*****
1060 CLS:DEFINT A-Z:B$="":BLK=0
1070 INPUT "LOAD FILE          =" ;NA$
1080 ON ERROR GOTO 1650
1090 OPEN NA$ FOR INPUT AS #2
1110 '**** COMMUNICATION INTIALIZE ****
1120 OPEN "COM1:9600,N,8,1" AS #1
1140 '***** STN NO SET *****
1150 INPUT "INPUT STATION NO    " ;A%
1160 STN%=A%+100
1170 IF STN% > 132 GOTO 1580
1180 STN%=RIGHT$(STR$(STN%),2)
1200 '***** INF BLK DATA LOAD *****
1210 IF BLK=16 THEN BLK=0:GOTO 1310
1220 IF BLK=15 THEN ED$=CHR$(&H29) ELSE ED$=CHR$(&H3B)
1230 PRINT:INPUT #2,LD$
1250 '***** INF BLK DATA SEND *****
1260 BL=BLK+10000:BLK=BLK+1
1270 BLK$=RIGHT$(STR$(BL),4)
1280 SD$="(A"+STN$+"BW"+BLK$+LD$+ED$+CHR$(&HD):GOTO 1370
1300 '***** PROGRAM BLK DATA LOAD *****
1310 PRINT:INPUT #2,LD$
1320 IF EOF(2) THEN ED$=CHR$(&H29) ELSE ED$=CHR$(&H3B)
1340 '***** PROGRAM BLK DATA SEND *****
1350 BL=BLK+10000:BLK=BLK+1:BLK$=RIGHT$(STR$(BL),4)
1360 SD$="(A"+STN$+"WB"+BLK$+LD$+ED$+CHR$(&HD)
1370 PRINT "SEND DATA          =" ;
1380 PRINT SD$;
1390 PRINT #1,SD$;
1410 '***** DATA RECEIVE *****
1420 B$="":TIME$="00:00:00"
1430 PRINT "RECEIVE DATA      =" ;
1440 B$=RIGHT$(B$,1)
1450 IF B$=CHR$(&HD) THEN 1500
1460 IF TIME$="00:00:03" THEN PRINT "TIMEOUT ERROR":BEEP:PRINT:GOTO 1610
1470 IF LOC(1)=0 THEN 1440
1480 B$=INPUT$(LOC(1),#1)
1490 PRINT B$;:GOTO 1440
1500 CMD$=MID$(SD$,5,1)
1510 IF CMD$=CHR$(&H42) THEN GOTO 1200
1520 IF RIGHT$(SD$,2)=CHR$(&H29)+CHR$(&HD) AND CMD$=CHR$(&H57) GOTO 1550
1530 GOTO 1310
1550 '***** COMPLETE *****
1560 CLOSE:PRINT:PRINT"COMPLETE":GOTO 1590
1570 END
1580 PRINT "STATION NO ERROR"
1590 INPUT "TEST CONTINUE Y/N  " ;A$
1600 IF A$="Y" THEN BLK=0:GOTO 1640 ELSE END
1610 INPUT "RETRY Y/N" ;A$
1620 IF A$="N" THEN END
1630 CLOSE COM1:OPEN NA$ FOR INPUT AS #2:BLK=0:GOTO 1110
1640 CLOSE COM1:GOTO 1050
1650 PRINT "NO SEARCH FILE" :GOTO 1590

```

# Appendices

## A.1 Transmission specifications

Item	Specifications
Interface	Conforms to RS485 (connector D-sub 15p)
Transmission mode	Half-duplex, 4-wire method
Signal polarity	PXA < RXB, TXA < TXB (potential of start bit)
Synchronizing	Start-Stop (asynchronous)
Topology	Bus (multi-drop)
Transmission speed	300, 1200, 2400, 4800, 9600, or 19200 bps (selected by T-PDS)
Transmission distance	1km maximum
Transmission code	ASCII
Data length	7 or 8 bits (selected by T-PDS)
Stop bit	1 or 2 bits (selected by T-PDS)
parity	Non, odd, or even (selected by T-PDS)
Number of stations	32 stations maximum
Error check	Parity, check-sum

### Connector pin assignment

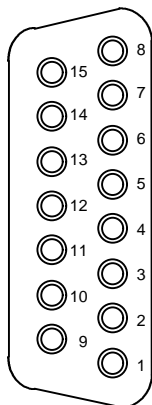

Pin No.	Signal name
1	FG
2	RXB
3	TXA
4	CTSA
5	RTSA
7	SG
10	RXB
11	TXB
12	CTSB
13	RTSB

**NOTE**  
▼▲▼

The female connector is provided on the front panel of PLC's CPU module.

A.2

RS485/RS232C converter The specifications of the RS485/RS232C converter are as follows.

Model: ADP-6237B (part number: EX25PADP6237B)

General specifications:

Item	Specifications
Power supply voltage	85 to 132/170 to 264 vac (50/60 Hz)
Power consumption	15 VA or less
Operating temperature	0 to 55 °C
Storage temperature	-20 to 75 °C
Humidity	20 to 90%RH
Withstand voltage	1500 Vac for 1minute

Transmission specifications:

Item		Specifications
RS232C side	Interface	Conforms to RS232C (connector D-sub 25p)
	Transmission distance	15 m maximum
RS485 side	Interface	Conforms to RS485 (terminal block)
	Transmission distance	1km maximum
	Number of stations	32 stations maximum

RS232C connector pin assignment:

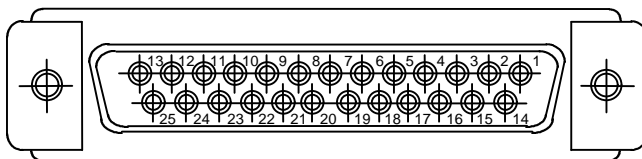

Pin No.	Signal name
1	FG
2	TXD
3	RXD
4	RTS
5	CTS
6	DSR
7	SG
8	CD
20	DTR

NOTE



The female connector is provided on the converter.

External feature: [mm]

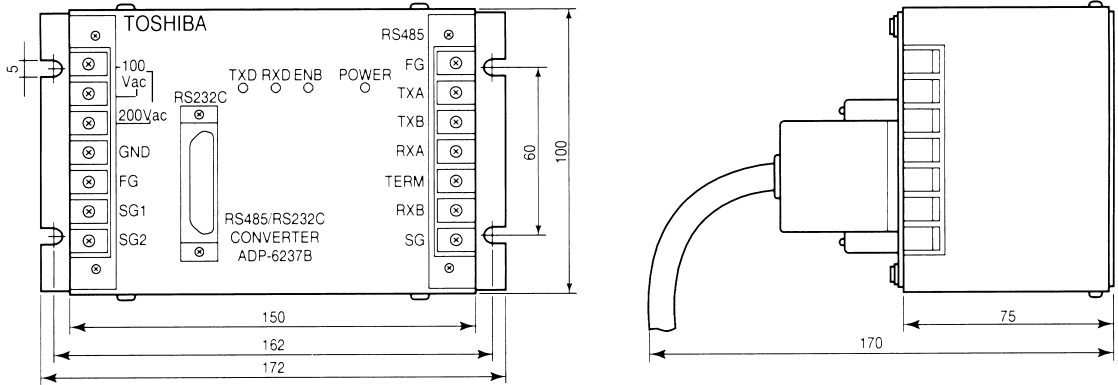

LEDs	Condition
TXD	Lit when TXD is mark state
RXD	Lit when RXD is mark state
ENB	Lit when CTS is mark state
POWER	Lit when power supply is normal

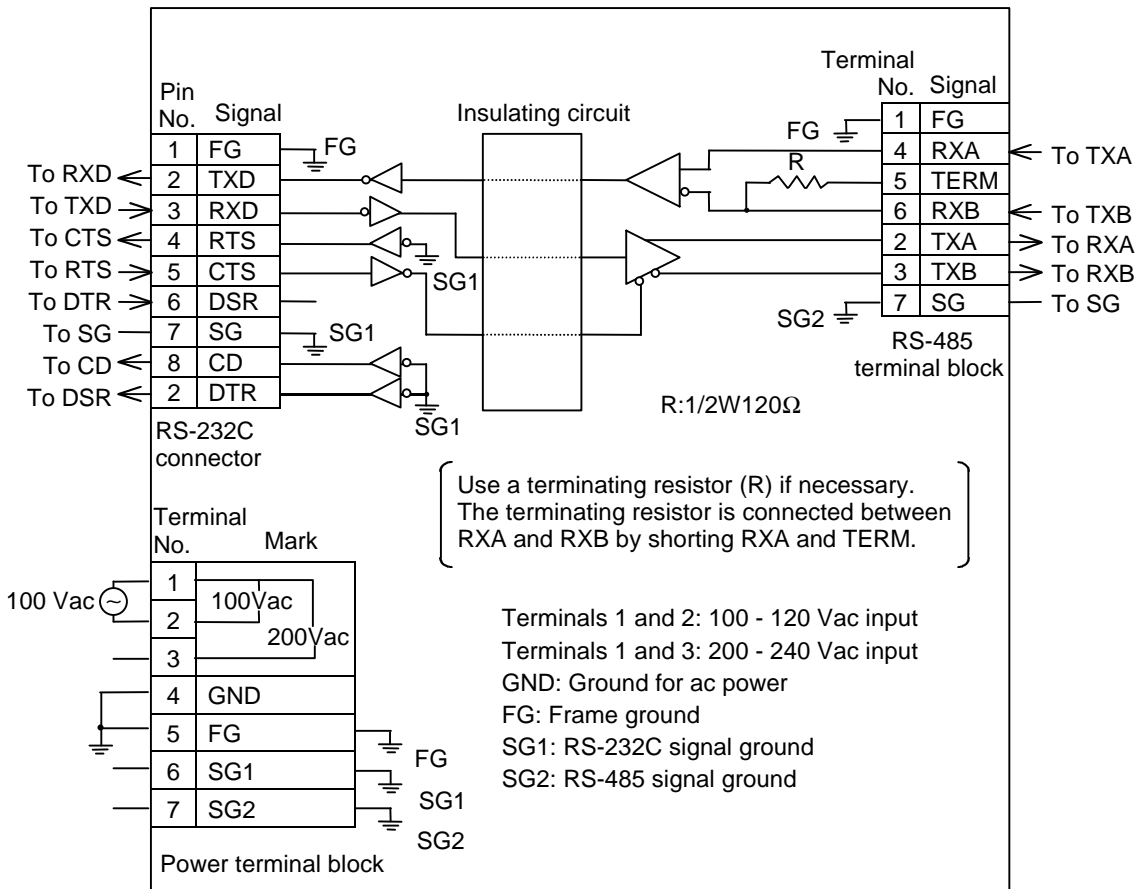

# **TOSHIBA**

## **TOSHIBA INTERNATIONAL (EUROPE) LTD.**

1 Roundwood Avenue  
Stockley Park, Uxbridge  
Middlesex, ENGLAND UB11 1AR  
Tel: 0181-756-6000 Fax: 0181-848-4969

## **TOSHIBA INTERNATIONAL CORPORATION**

**Industrial Division**  
13131 West Little York Road  
Houston, TX. 77041, U.S.A.  
Tel: 713-466-0277 Fax: 713-466-8773

## **TOSHIBA INTERNATIONAL CORPORATION PTY. LTD.**

**Industrial Division**  
2 Morton Street, Parramatta  
N.S.W. 2150, AUSTRALIA  
Tel: 02-9768-6600 Fax: 02-9890-7542

## **TOSHIBA CORPORATION**

**Industrial Equipment Department**  
1-1, Shibaura 1-chome, Minato-ku  
Tokyo 105-8001, JAPAN  
Tel: 03-3457-4900 Fax: 03-5444-9268