

Integrated Controller **V** series

model 2000

PROFIBUS Module User's Manual for S2T/S2E

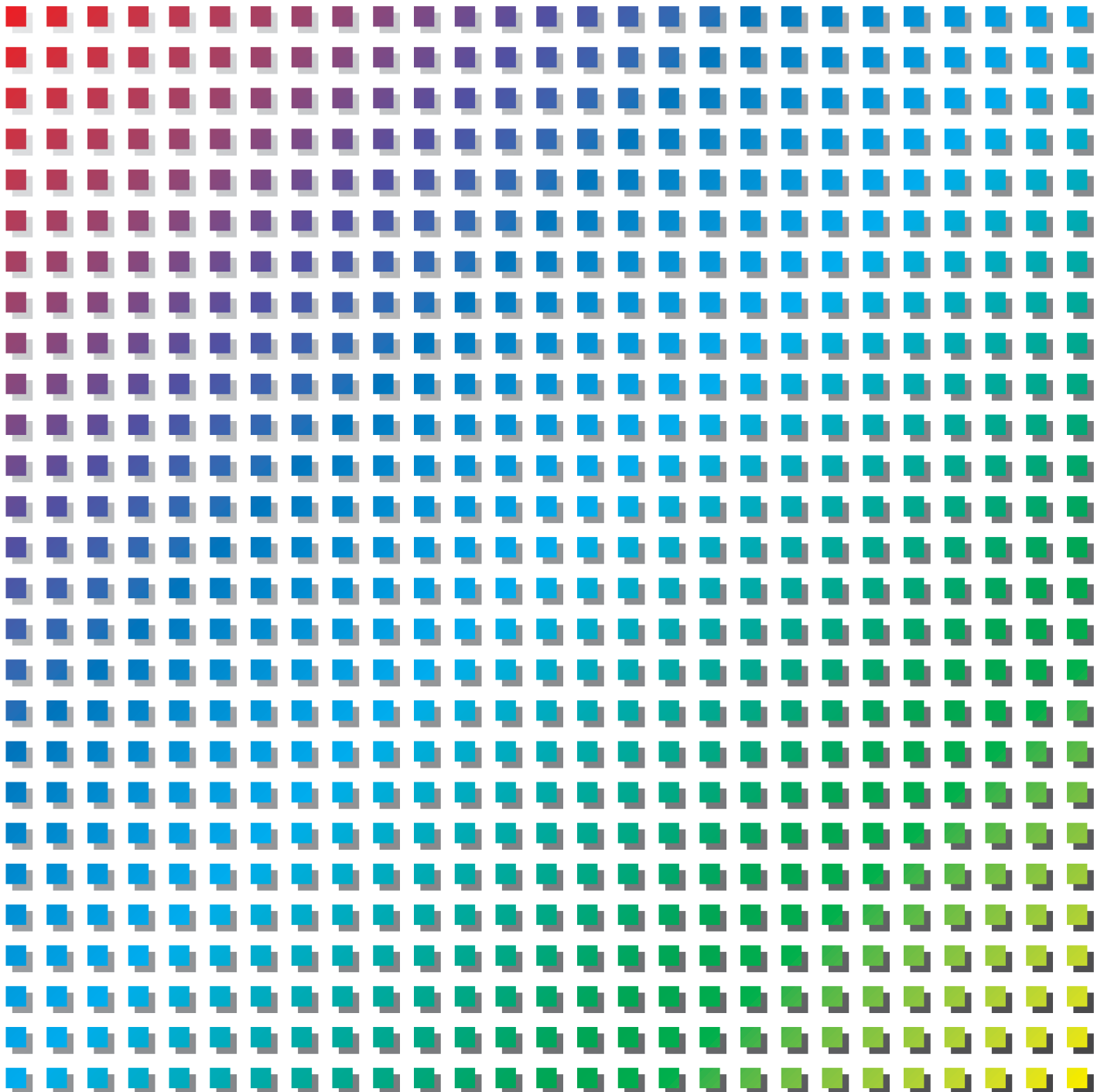

Important Information

No patent liability is assumed by TOSHIBA Corporation with respect to use of information, illustrations, circuits, equipment or examples of application in this publication.

TOSHIBA Corporation reserves the right to make changes and improvements to this publication and/or related products at any time without notice. No obligation shall be incurred other than as noted in this publication.

This publication is copyrighted and contains proprietary material. No part of this book may be reproduced, stored in a retrieval system, or transmitted, in any form or by any means — electrical, mechanical, photocopying, recording, or otherwise — without obtaining prior written permission from TOSHIBA Corporation.

PROSEC, TOSLINE and TOSDIC are trademarks or registered trademarks of TOSHIBA Corporation.

IBM is a registered trademark of International Business Machines Corporation.

Microsoft, MS-DOS, Windows and Windows NT are registered trademarks of Microsoft Corporation in the U.S.A. and other countries.



DeviceNet is a trademark of the Open DeviceNet Vender Association, Inc.

Safety Precautions

This manual contains important information for the operator to operate this product safely and correctly and avoid bodily injury and property damage.



Grasp the meanings of the following marks and their descriptions before reading this manual.

●Hazard Classifications

 WARNING	Indicates a potentially hazardous situation which, if not avoided, could result in serious injury or death.
 CAUTION	Indicates a potentially hazardous situation which, if not avoided, can result in minor or moderate injury, or property damage. It can also be used to alert against unsafe practices.

- (Note) 1. Serious injury means loss of sight, injury, burns (high temperature, low temperature), electrical shock, fracture, or intoxication which leaves aftereffects or requires hospitalization or need to go the hospital for a long time.
2. Injury means hurt, burn, or electric shock which does not require hospitalization or going to the hospital for a long time.
3. Property damage means extended breakdown of assets and materials.

●Notation of Markings

	Indicates a "may not" mark. The concrete forbiddance is indicated with a pictograph or wording.
	Indicate a mandatory action that you should never fail to do. The concrete content is indicated inside or near the circle with a pictograph or wording.
	Indicates a caution. The concrete content is indicated inside or near the triangle.

(Note) The descriptions of forbiddance, mandatory, and caution marks are subject to change, depending on the labels on the main unit.

1. Markings used on the model 2000 and in this Manual

Make sure warning markings are attached on the model 2000.
If any of them are missing or the wording is illegible, contact Toshiba's Service Department

2. Precautions on Installation

WARNING



Mandatory

Operation without grounding may cause accidental fire or shock.

CAUTION



Mandatory

Avoid the following locations when installing or storing this module.

- Locations where there is dust, salinity or ion particles
- Locations where there are corrosive gases (SO₂, H₂S) or flammable gases
- Locations where vibration or shock occurs beyond the allowance
- Locations where there is condensation due to sharp temperature variations
- Locations where the ambient temperature exceeds the allowance range.
Please perform compulsive air-cooling in the location where the ambient temperature exceeds 45°C.
- Locations where the relative humidity exceeds the allowance range
- Locations where this module is exposed to direct sunlight
- Locations where strong electric radiation or magnetic field is generated



Mandatory

Improper the installation or wiring of the system can cause not only insufficient performance but also malfunction and failure of this module.

Installation in an unspecified direction or improper installation can cause fall-off, fire, interference, or malfunction of this module.



Mandatory

Install this module at a place where maintenance and inspection are easy to do. Otherwise, recovery from failure may take much more time, leading to a serious accidents.



Forbidden

Do not cover the hole of this module, and the ventilator/air inlet of the system. Otherwise, overheating, etc. can cause fire or malfunction.



Mandatory

Avoid entering wire scraps or other foreign debris into this module, and related equipment. Otherwise, it can cause fire, failure or malfunction.

3. Precautions on Wiring

WARNING



Mandatory

Be sure to turn off power before wiring.
Otherwise, it can cause electric shock or malfunction of this module.

CAUTION



Mandatory

It is assumed that the users have general knowledge of industrial electrical control systems.

4. Precautions for Operation

WARNING



Mandatory

Configure emergency stop interlocking circuit outside the model 2000. Otherwise, failure and malfunction of the model 2000 can cause human injury, machine damage or serious accidents.

CAUTION



Forbidden

This module is dedicated to the model 2000. Mount them on the bases of the model 2000. Do not use them by themselves for other purposes. Otherwise, it can cause electrical shock or injury or malfunction.



Mandatory

When you attempt to perform program change, forced output, RUN/HALT controls, etc during operation, carefully check for safety. Improper operation or negligence in checking safety conditions can cause machine damage or serious accidents.



Mandatory

Mount the modules on the base securely until they click, and fix them on the base with screws. Insufficient installation can cause failure or malfunction.



Mandatory

Set the operating switches of this module according to this manual. Improper setting can cause failure or malfunction.



Mandatory

Sample programs and circuits described in this manual are provided for explaining the operations and applications of the S2. You should test completely before using them as a part of your application system.



Mandatory

Configure the external circuit to turn on power according to the following sequence.

Turn on the power of model 2000

→ Turn on the power for the I/O module and external load power supplies

Otherwise, it can cause machine damage, malfunction or accidents.



Forbidden

Turn off power immediately if this module or related equipment emitting smoke or odor. Operation under such situation can cause fire or electrical shock. Also unauthorized repairing will cause fire or serious accidents. Do not attempt to repair. Contact Toshiba for repairing.

5. Safety Precautions on Maintenance and Inspection



WARNING



Mandatory

Turn off power when removing any units, modules, terminal blocks or wired cables after installing.

Otherwise it can cause failure, malfunction or electrical shock.



Forbidden

Do not disassemble or modify this module and related equipment in hardware nor software. Otherwise it can cause failure, malfunction, electrical shock or injury.

CAUTION



Forbidden

Be careful not to hit or fall off this module by accident.
Excess shock can cause failure.



Mandatory

Place this modules removed from the unit on a conductive mat or conductive bag (containing a spare board, etc.) on an grounded desk. Otherwise, static electricity can damage components of the module.



Mandatory

Touch a grounded metal part to discharge the static electricity on your body before touching this module.
Otherwise, charged static electricity on your body can cause malfunction or failure.



Mandatory

Use soft cloth to clean this module.
Use water-dipped and squeezed cloth to clean it if dirty.
Leaving this module dirty can cause mistaking or malfunction.



Forbidden

Do not apply benzene and thinner when cleaning this module.
Otherwise, it can cause deformity or discoloration the panel or case of this module.

6. Safety Precautions in Daily Operation

WARNING



Mandatory

Apply power of the specified ratings (voltage fluctuation range, frequency, output rating, etc.) described in this manual. Otherwise, it can cause malfunction, machine damage or fire due to overheat.



Mandatory

Turn off power immediately if the ambient temperature or internal temperature exceeds beyond normal range or if failure is occurred in this module. Contact Toshiba for repairing. Operation under such situation can cause fire or electrical shock. Check the vent of this module periodically. If vent is closed, it can cause raise of temperature.

CAUTION



Forbidden

Do not touch any components, terminals, connectors or printed circuit boards in the module. Otherwise, it can cause the IC or LSI or the like to be broken by static electricity, resulting in failure or malfunction. Also, the edge of components can cause injury.



Forbidden

Do not forcibly bend or pull or distort the power cord and other cables. Otherwise, they can be cut off or cause overheat.



Forbidden

Do not disassemble or modify this module and related equipment. Otherwise, it can cause malfunction or failure.



Forbidden

Do not enter wire scraps or other foreign debris into this module and related equipment. Also, do not insert metal parts into them. They can cause fire or accidents.

7. Safety Precautions on Disposal

CAUTION



Mandatory

Observe local regulations for disposal of the this module.



Mandatory

Following information is only for EU-member states:

The use of the symbol indicates that this product may not be treated as household waste. By ensuring this product is disposed of correctly, you will help prevent potential negative consequences for the environment and human health, which could otherwise be caused by inappropriate waste handling of this product. For more detailed information about the take-back and recycling of this product, please contact your supplier where you purchased the product.



Limitation of Applications

- The model 2000 has been designed and manufactured for use in an industrial environment. However, the mode 2000 is not intended to be used for systems which can endanger human life (note 1).
- Consult Toshiba if you intend to use this module for a special application which involves human life and has great influence on the maintenance of the public function (note 2). This is why such application requires special care on the operation, maintenance, and control of the system (note 3).

(Note 1) The systems which can endanger human life are life maintenance systems, equipment installed in the surgery, and other medical equipment.

(Note 2) The systems which involve human life and have great influence on the maintenance of the public function mean the main control system of a nuclear power plant, safety and protection system of a nuclear power facility, transport operation and control systems for mass transportation, control systems of aviation and space systems, and other systems and subsystems where safety is critical.

(Note 3) "Special care" means to build a safety system (foolproof design, fail safe design, redundancy design, etc.) in full consultation with Toshiba's engineers.

Immunity

- Toshiba is not liable for any loss caused by fire, earthquake, action by a third party, or other accidents, or the operator's intentional or accidental misuse, incorrect use, or use under abnormal condition.
- Toshiba is not liable for any incidental loss caused by the use or non-use of this product, such as loss of business profits, suspension of business, or loss or change of data on memory.
- Toshiba is not liable for the loss caused by an operation contradictory to any of the instructions stated in this manual.
- Toshiba is not liable for the loss caused by an incorrect operation in combination with other equipment.
- Toshiba is not liable for the loss caused by a malfunction in combination with an application program made by the customer.

NOTE:

Use cellular phones and PHSs at least one meter away from the working the model 2000 transmission cables, and I/O bus cable. Otherwise, the system can malfunction.

Preface

This manual presents the specifications of the data communication network "PROFIBUS" master module PF611 and slave module PF612 for the Integrated Controller V Series model 2000, and describes its operating procedures. Be sure to read this manual in order to use the module correctly.

This manual consists of the following chapters:

Chapters 1, 2, and 3 describe the outline, configuration, and specification of this module. Chapter 4 describes the operation and function.

Chapters 5, 6, and 7 describe how to startup the module, register and setup the controller, and control the module.

Chapter 8 provides the RAS information. Check the contents.

The Appendix provides information on errors ,transmission cable and sample programs. Refer it as necessary.

First, be sure to read the Safety Precautions in order to correctly use this module.

Be Sure To Observe The Following

Observe the following to ensure the safety of the operator in using the equipment and to keep it in normal operating condition.

1. Read this Manual carefully before using.
2. Avoid installing or storing the equipment in the following places:
 - (1) Where there is large amount of dust.
 - (2) Where there is corrosive gas (such as SO₂, H₂S)
 - (3) Where there is vibration or shock.
 - (4) Where the temperature is outside the allowed range described in this manual.
(Operating ambient temperature: 0 to 45°C)
Please perform compulsive air-cooling in the location where the ambient temperature exceeds 45°C.
 - (5) Where humidity is high or where there is condensation.
3. If the device internal or external temperature becomes abnormally high or if there is a malfunction, stop operation, turn off the power and contact the nearest Toshiba service station.
4. Do not open the case while operating.
5. Do not modify the equipment.

CONTENTS

Safety Precautions	i
Preface	xi
Chapter 1 Module Overview	1
1.1 General	1
Chapter 2 Configuration	3
2.1 System Configuration Example	3
2.2 PF611 Module External	4
2.3 PF612 Module External	5
2.4 Name of PF611 Module Components and Parts	6
2.5 Name of PF612 Module Components and Parts	8
2.6 Configurator	12
Chapter 3 Specifications	13
3.1 System Specification	13
3.2 PF611/PF612 Module Specification	14
Chapter 4 Operation and Function	15
4.1 Cyclic Transmission	15
4.2 Cyclic Transmission Time	17
4.3 Startup Procedure	17
4.4 Application Program (Start Procedure)	19
4.5 Access for PF611/PF612 Controller Interface Memory	20
Chapter 5 Transmission Parameter Setup	21
Chapter 6 Operation Mode	23
6.1 Operation Mode	23

CONTENTS ---

- Chapter 7 Module Control 25
 - 7.1 Controller Interface Memory Map 25
 - 7.2 Module Control Information 27
 - 7.3 Reset PF Module 28
 - 7.4 Activate PF Module 28
 - 7.5 PF612 Transmission Word Count Setup 29

- Chapter 8 RAS Information 31
 - 8.1 PF611 RAS Information 31
 - 8.2 PF611 DP system Information 36
 - 8.3 PF612 RAS Information 38

- Chapter 9 Appendix 39
 - 9.1 Error Inspection 39
 - 9.2 Installing modules and Transmission Cable 42
 - 9.3 Connectors 43
 - 9.4 Sample Application Programs (T-PDS) 44

Chapter 1 Module Overview

1.1 General

PROFIBUS is an international standard network developed by Siemens that is certified by German industrial Standards (DIN19245), European Standards (EN50170), and International Standards (IEC-61158). At the actual application level, there are more than 1,100 companies participating in the user group with approximately 300 vendors providing approximately 2,000 different products in the European and North American market. PROFIBUS is classified into DP, FMS, and PA which respectively applies to high-speed remote I/O, inter-controller message communication, and instrumentation applications. The PF611 and PF612 supports PROFIBUS-DP, which is the most popular among these.

The PROFIBUS module enhances connectability by providing PROFIBUS connection to integrated controllers in addition to conventional device net module.

The product lineup is as follows:

No.	Application	Type
1	For model 2000 (master)	GPF611**S
2	For model 2000 (slave)	GPF612**S

Summary of PROFIBUS module.

Connected device	Integrated Controller V Series model 2000 S2T and S2E.
Engineering Tool	PROSEC T-Series engineering tool T-PDS.
Number of transmission stations	122 (maximum) (32 in each segment, expandable with repeater (up to 3))
Transmission speed	9.6 Kbps to 12 Mbps.
Number of connectable modules	Up to 8 devices (total of PF611 and PF612).
Transmission size	PF611: Transmit 512 bytes, Receive 512 bytes PF612: Transmit 244 bytes, Receive 244 bytes
Transmission cable	RS485 shielded twisted pair cable is used. Optical fiber can be used partially if optical repeaters are used.
Function	Cyclic process data transmission between controller and slave devices.
Conforming standard	PF611 : EN50170 (DPV0) Profibus Class 1 Master PF612 : EN50170 (DPV0) Profibus-DP Slave
Parameter	PF611: Transmission parameters are set from custom configurator. PF612: Transmission parameters are set from switch on the module or User program on controller.

The user who combines S2T/S2E and PF611/PF612 and operates must issue various requests to PF611/PF612 by using the READ/WRITE instruction in the S2T/S2E application program.

The following module is used as the PROFIBUS-DP transmission controller for this module.

Master module (PF611):

HMS AnyBus Profibus DP Master (ABM-PDP)

Slave module (PF612):

HMS AnyBus Profibus DP Slave (ABS-PDP)

Chapter 2 Configuration

2.1 System Configuration Example

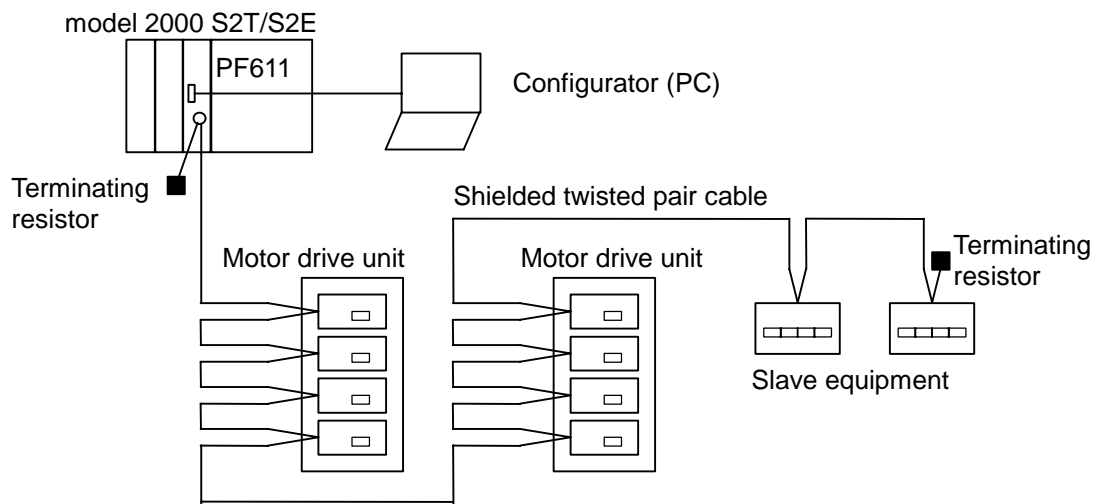

Figure 2-1 System configuration example (1)

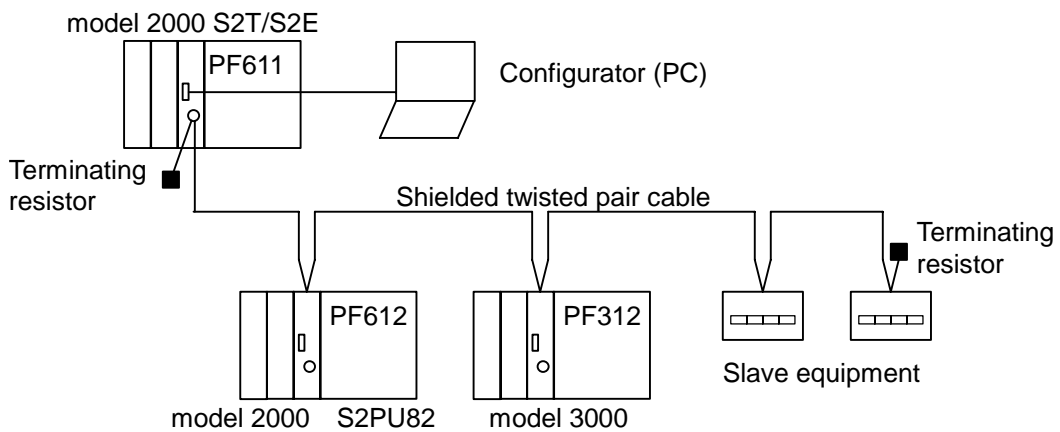

Figure 2-2 System configuration example (2)

2.2 PF611 Module External

2

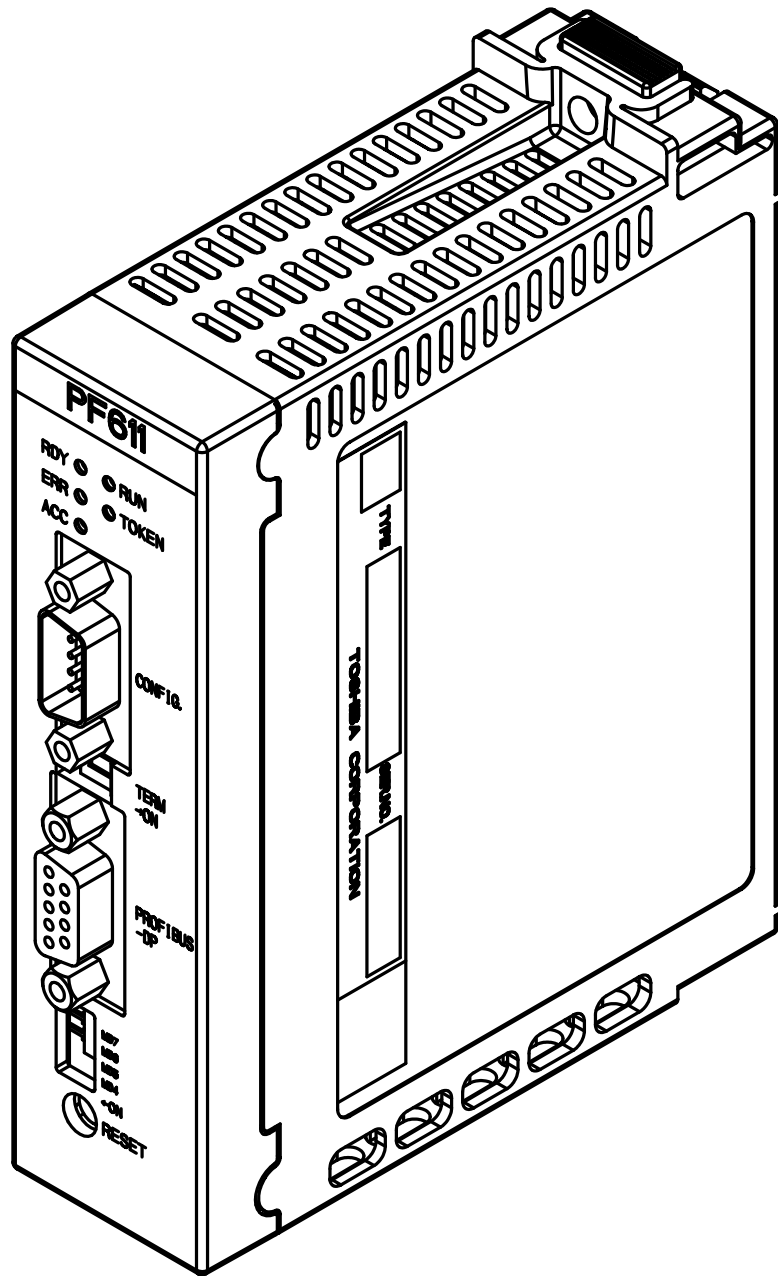

Figure 2-3 PF611 appearance drawing

2.3 PF612 Module External

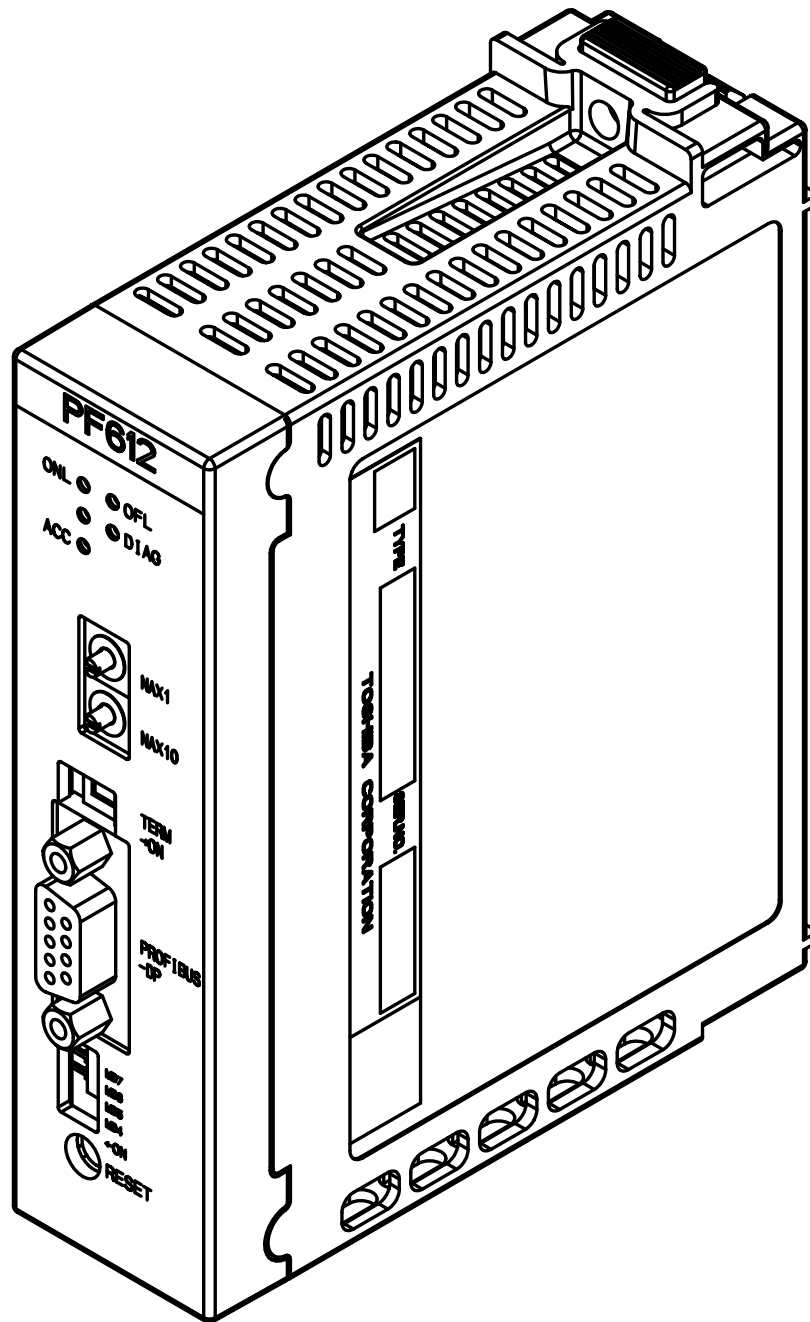

Figure 2-4 PF612 appearance drawing

2.4 Name of PF611 Module Components and Parts

2

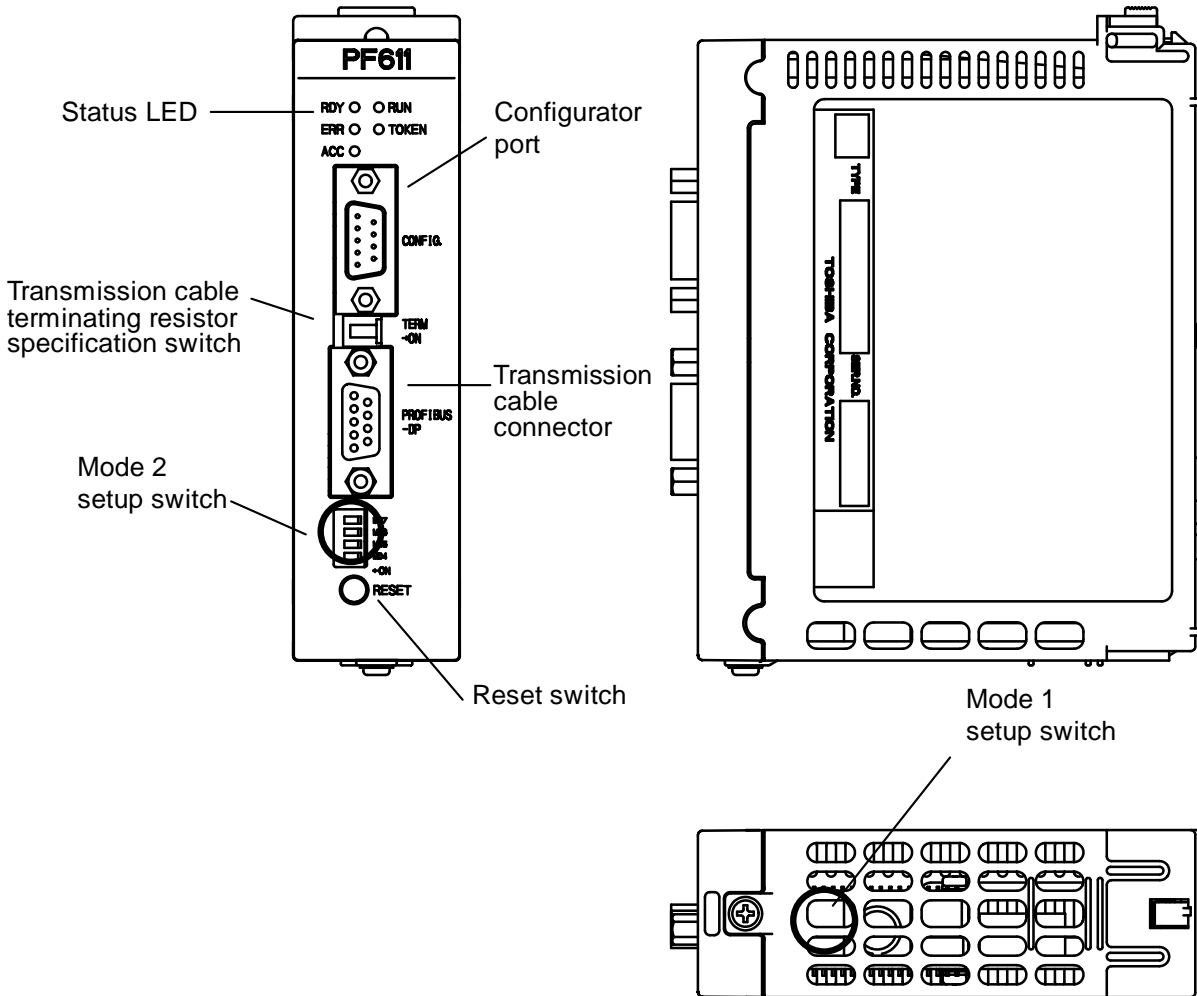

Figure 2-5 Name of components and parts

- Mode 1 setup switch (hexadecimal rotary switch)
Used to specify module internal operation.
Set to "4" for PF611 (Shipment setting is "4").
- Mode 2 setup switch (binary DIP switch)
Used to set the transmission status when there is a controller error.

Table 2-1 Mode 2 setup switch

Mode	MD4	MD5	MD6	MD7	Transmission Status
Stop	OFF	OFF	OFF	OFF	Stops transmission.
Resume 1	ON	OFF	OFF	OFF	Resumes transmission using the transmission data prior to error.
Resume 2	ON	ON	OFF	OFF	Resumes transmission using 0 as transmission data.

Setting other than above will result in module failure.

MD4 to 7 are all set to "OFF" at shipment.

- Status LED

Table 2-2 Status LED

RDY (green)	ON	Transmission module normal
	Cyclic flash (1 Hz)	Firmware not stored.
	Cyclic flash (4 Hz)	Hardware error or system error or in downloading firmware configuration data
	OFF	Hardware failure
RUN (green)	ON	Communicating
	Cyclic flash (4 Hz)	Standby
	Acyclic flash	Configuration error or fatal error
TOKEN (green)	ON	Token retained
	OFF	No token
ERR (red)	ON	Error on communication line
	OFF	No error detected
ACC(green)	ON	Controller accessing
	OFF	Controller not accessing

- Configurator port (CONFIG)
PC (PROFIBUS-DP configurator) connector.
- Transmission cable terminating resistor specification switch (TERM)
TERM (terminating resistor) → ON: Terminated with terminating resistor. Turn on at nodes on both ends.
- Transmission cable connector (PROFIBUS-DP)
PROFIBUS-DP transmission cable connector
- Reset switch (RESET)
Press when the PF611 is abnormal or when initializing the PF611 independent of the controller.

2.5 Name of PF612 Module Components and Parts

2

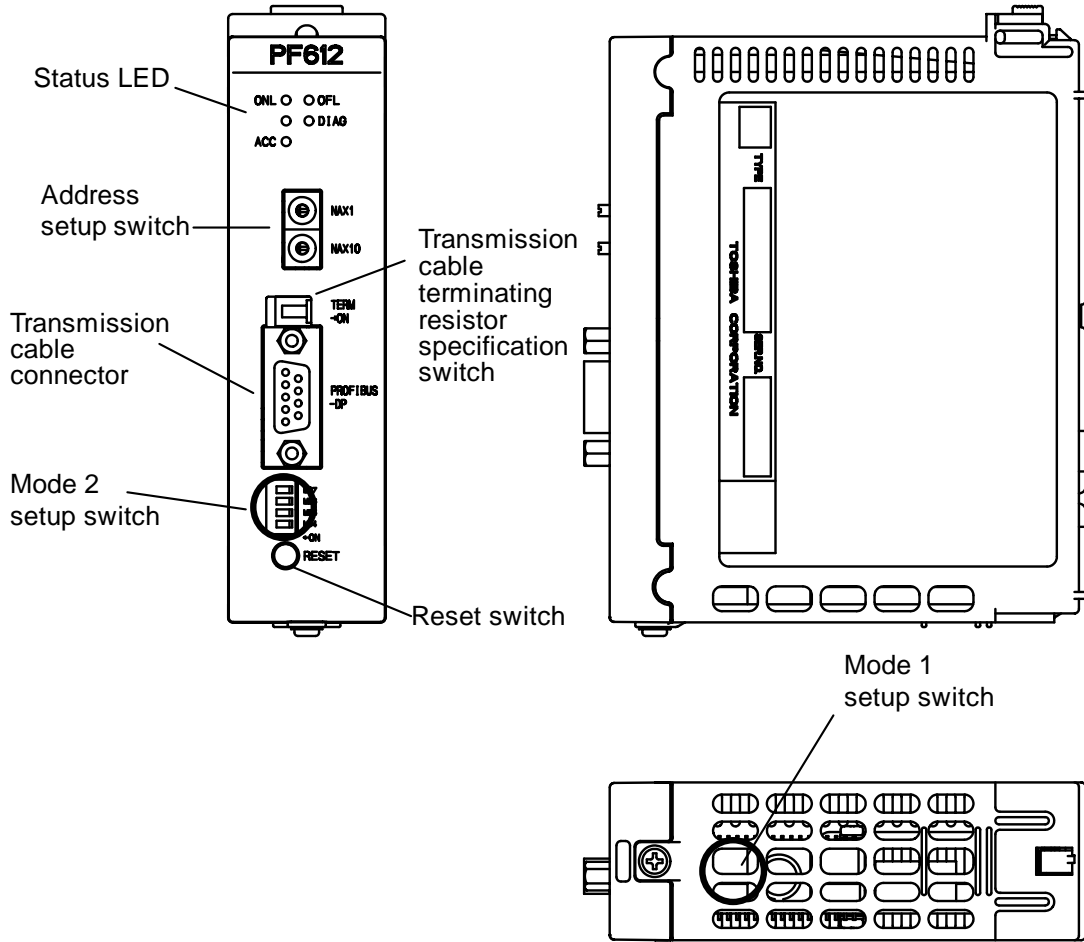

Figure 2-6 Name of components and parts

- Mode 1 setup switch (hexadecimal rotary switch)
Sets the transmission word count. Set in combination with MD6 and MD7 of the Mode 2 setup switch.

Table 2-3 Mode 1 setup switch

MD6	MD7	MODE1	I/O byte (word) count	
OFF	OFF	1	IN/OUT	2Byte(1Word)
OFF	OFF	2	IN/OUT	4Byte(2Word)
OFF	OFF	3	IN/OUT	8Byte(4Word)
OFF	OFF	4	IN/OUT	16Byte(8Word)
OFF	OFF	5	IN/OUT	32Byte(16Word)
OFF	OFF	6	IN/OUT	64Byte(32Word)
OFF	OFF	7	IN/OUT	128Byte(64Word)
OFF	OFF	8	IN/OUT	208Byte(104Word)

Set the same number of words for transmit and receive.

MD6	MD7	MODE1	Input byte (word) count	
ON	OFF	1	INPUT	2Byte(1Word)
ON	OFF	2	INPUT	4Byte(2Word)
ON	OFF	3	INPUT	8Byte(4Word)
ON	OFF	4	INPUT	16Byte(8Word)
ON	OFF	5	INPUT	32Byte(16Word)
ON	OFF	6	INPUT	64Byte(32Word)
ON	OFF	7	INPUT	128Byte(64Word)
ON	OFF	8	INPUT	244Byte(122Word)

Set only transmit word count.

MD6	MD7	MODE1	Output byte (word) count	
OFF	ON	1	OUTPUT	2Byte(1Word)
OFF	ON	2	OUTPUT	4Byte(2Word)
OFF	ON	3	OUTPUT	8Byte(4Word)
OFF	ON	4	OUTPUT	16Byte(8Word)
OFF	ON	5	OUTPUT	32Byte(16Word)
OFF	ON	6	OUTPUT	64Byte(32Word)
OFF	ON	7	OUTPUT	128Byte(64Word)
OFF	ON	8	OUTPUT	244Byte(122Word)

Set only receive word count.

MD6	MD7	MODE1	Input/Output byte (word) count	
ON	ON	-	Set from controller See Chapter 7 for details	

Mode enabling setup from the controller

Any setting other than the above will cause the module to fail.
Set to "1" at shipment.

- Mode 2 setup switch (binary DIP switch)
Used to set the action when there is a controller error or transmission error.

Table 2-4 Mode 2 setup switch (1)

Mode	MD 4	MD 5	Transmission	Abnormal	Transmit data	Receive data
Halt 1	OFF	OFF	Halt	CE	-	-
				TE	-	Value just before error
Halt 2	OFF	ON	Halt	CE	-	-
				TE	-	0
Resume 1	ON	OFF	Resume	CE	Value just before error	Data received from master
				TE	-	Value just before error
Resume 2	ON	ON	Resume	CE	0	Data received from master
				TE	-	0

CE: Controller Error TE: Transmission Error

Used to set the combination during transmission word count setup (MODE 1 switch).

Table 2-5 Mode 2 setup switch (2)

Mode	MD6	MD7	Combination
Transmit/receive	OFF	OFF	Transmit + Receive (IN/OUT)
Transmit	ON	OFF	Transmit only (INPUT)
Receive	OFF	ON	Receive only (OUTPUT)
Controller	ON	ON	Set freely from controller

MD4 to 7 are all set to "OFF" at shipment.

- Address setup switch (decimal rotary switch)
 - Use to set the slave's node address (1 to 99). Set to "1" at shipment.
 - NA x 10: 10's digit (module lower side)
 - NA x 1: 1's digit (module upper side)

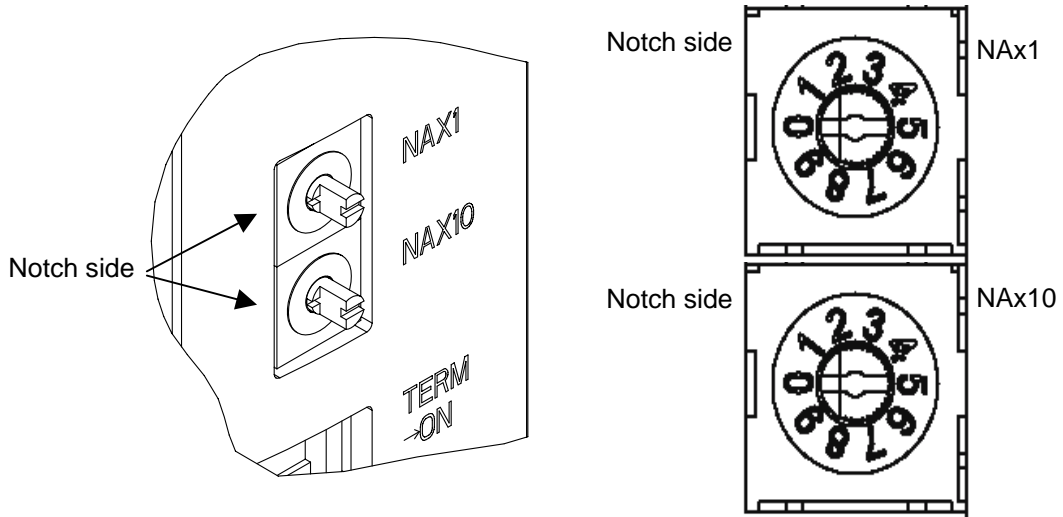

The above figure is set to node address "00". (Actual setting should be between 1 and 99.) Align the notch side of the knob with the desired value.

Figure 2-7 Node address setting

- Status LED

Table 2-6 Status LED

ONL (green)	ON	Communicating
	OFF	Other than communicating
OFL (red)	ON	Non-communicating
	OFF	Other than non-communicating
DIAG (red)	Cyclic flash (1 Hz)	Setup (configuration information) error
	Cyclic flash (2 Hz)	Setup (user parameter) error
	Cyclic flash (4 Hz)	PROFIBUS ASIC initialization error
	OFF	No diagnostic information
ACC (green)	ON	Controller accessing
	OFF	Controller not accessing

LED under ONL LED is always OFF.

- Transmission cable terminating resistor specification switch (TERM)
TERM (terminating resistor) → ON: Terminated with terminating resistor.
Turn on at nodes on both ends.
- Transmission cable connector (PROFIBUS-DP)
PROFIBUS-DP transmission cable connector.
- Reset switch (RESET)
Press when the PF612 is abnormal or when initializing the PF612 independent of the controller.

2.6 Configurator

The PROFIBUS-DP configurator is used to monitor the PROFIBUS status, read/write cyclic data, and set parameters from a PC.

Use the following configurator for PF611.

Name : Sycon
 Manufacturer : HMS (Sweden)
 Supported OS : Windows 95/98/NT/2000

- Connecting to PF611

The PC and PF611 are connected through RS232C. Use the following cable to connect the RS232C connector of the PC with the CONFIG connector (9 pin male) of the PF611.

Cable : Cross cable with 9-pin male connectors at both ends
 (Cross-cable for IBM-AT compatible PC)

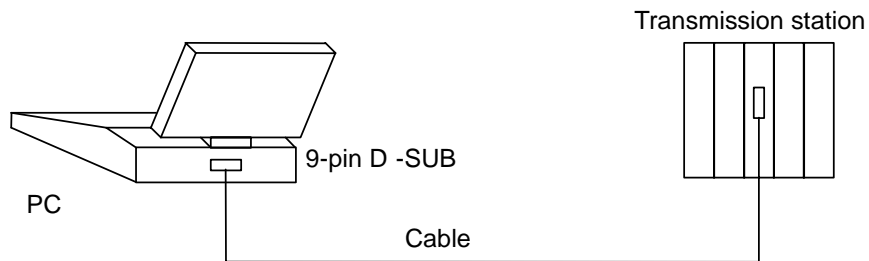

Figure 2-8 Configurator connection

Chapter 3 Specifications

3.1 System Specification

Table 3-1 System specification

Item	Description
Transmission path configuration	Bus
Number of transmission stations	122 (maximum) (32 in each segment, expandable with repeater (up to 3))
Transmission cable	RS-485 Shielded twisted pair cable
Transmission speed	9.6 K to 12 Mbps
Transmission code	Manchester
Modulation method	Baseband
Access method	Token passing
Physical layer	RS-485, with insulation by photo coupler
Communication service	(1) Cyclic transmission

3.2 PF611/PF612 Module Specification

Table 3-2 PF611/PF612 module specification

Item	Description	
	PF611	PF612
Connected device	Integrated controller model 2000 S2T/S2E	
Engineering tool	PROSEC T-Series engineering tool (T-PDS)	
Connection bus	G2 I/O bus	
Number of connectable modules	Up to 8 (total of PF611 and PF612)	
Services	Process data (cyclic data) I/O Input 512 bytes Output 512 bytes	Process data (cyclic data) I/O Input 244 bytes Output 244 bytes
Access method from controller	Direct I/O with READ / WRITE Instruction	
Parameter setup method	Custom configurator	Setup switch or User program on controller
Current consumption	1.2 A	1.0 A
Operating ambient temperature	0 to 45°C Please perform compulsive air-cooling in the location where the ambient temperature exceeds 45°C.	
External dimensions	G2 I/O, occupies 1 slot	
Conforming standard	EN50170 (DPV0)	
	Profibus Class 1 Master	Profibus-DP Slave
RAS function	<ul style="list-style-type: none"> • Module status • Healthy counter • PROFIBUS-DP status 	

4.1 Cyclic Transmission

The PF611 master cyclically reads input information from the slaves and cyclically writes output information to the slaves.

The I/O area of the PF611 to the slaves are shown in the following table. Communication with slaves is performed by reading or writing to the specific address from the controller.

Table 4-1 PF611 I/O area

Address	Name	Function
100h-1FFh	Write data (256 words)	Output area to slave
200h-2FFh	Read data (256 words)	Input area from slave

The I/O area of the slave module (PF612) to the master is shown in the following table. Communication with slaves is possible by reading or writing to the specific address from the controller.

Table 4-2 PF612 I/O area

Address	Name	Function
100h-17Ah	Write data (122 words)	Output area to master
200h-27Ah	Read data (122 words)	Input area from master

A conceptual diagram of cyclic transmission is shown below.

The I/O address of the slave is set from the configurator.

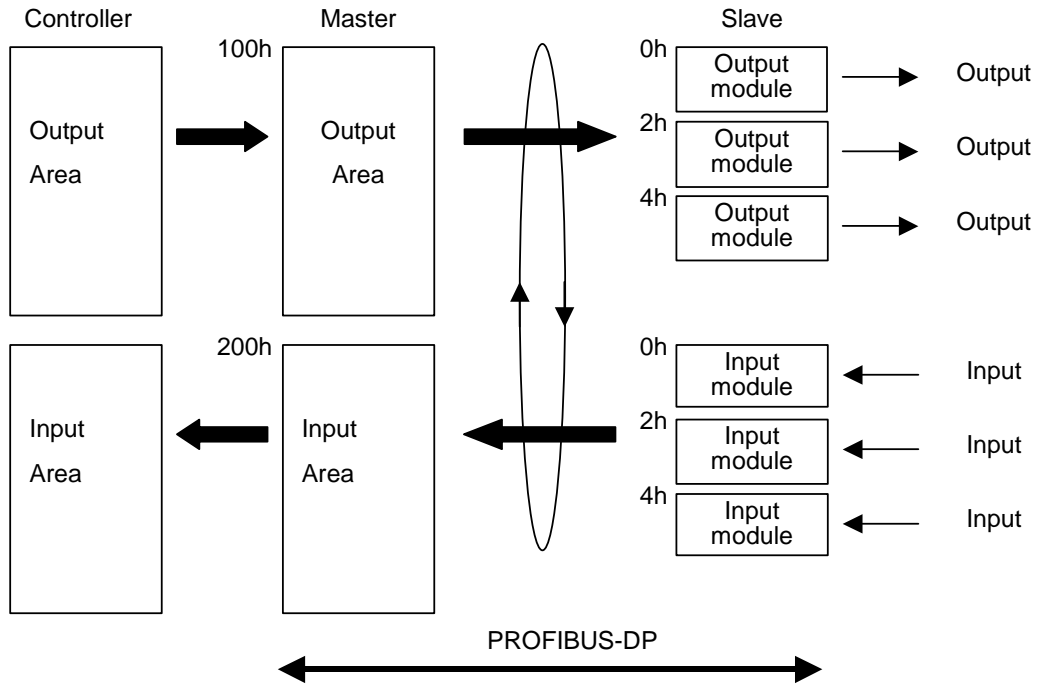

Figure 4-1 Cyclic transmission (PF611 and general I/O combination)

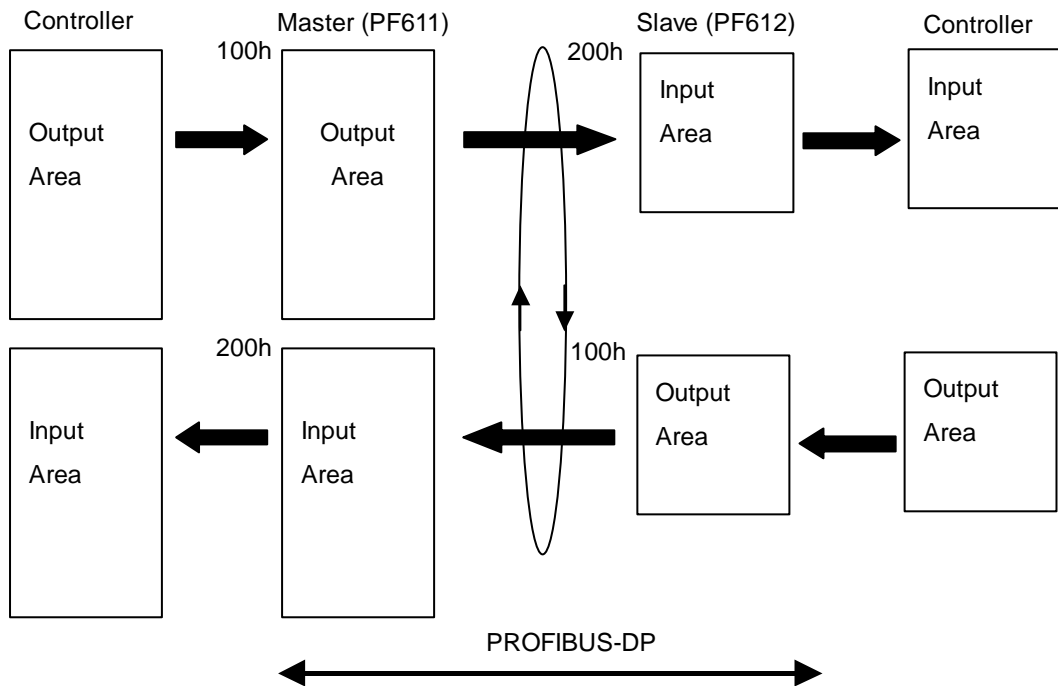

Figure 4-2 Cyclic transmission (PF611 and PF612 combination)

4.2 Cyclic Transmission Time

The cyclic transmission time depends on the transmission speed, number of slaves, and the number of transmitted words.

The time required to read from the PF611 output area, transmit to slave, receive from slave, and write to PF611 input area is shown in the following table. (Excluding controller I/O time and slave side I/O time.)

Table 4-3 Cyclic transmission time

Transmission speed	12 Mbps		1.5 Mbps
Configuration	1 to 1	1 to 4	1 to 4
Transmitted words	Transmit: 16, Receive: 16	Transmit: 64, Receive: 64	Transmit: 64, Receive: 64
Transmission time	Approx. 4 ms	Approx. 5 ms	Approx. 10 ms

These are actual measured values when an HMS ABS-PDP is connected as slave.

4.3 Startup Procedure

The following configuration is used as an example to describe the startup procedure.

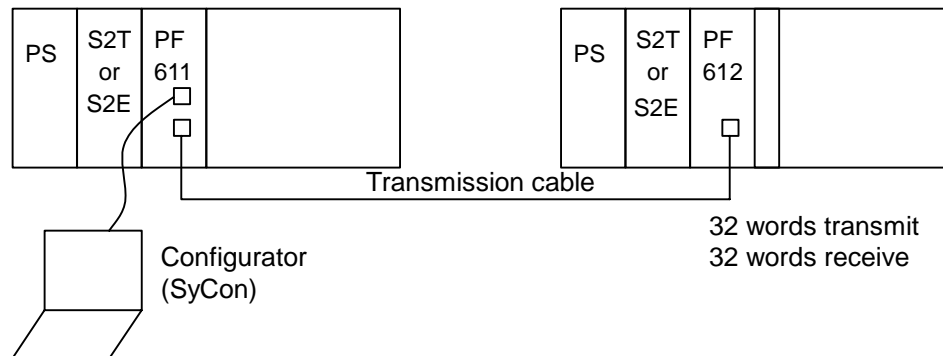

Figure 4-3 Startup procedure configuration example

1	<p>Provide the following modules, tools, and cables.</p> <ul style="list-style-type: none"> • Base unit • Power module • S2T/S2E controller • PF611 • PF612 • Tool PC (May be shared between engineering tool and configurator.) • Integrated controller engineering tool (including PC connection cable) • PROFIBUS configurator (SyCon) <p>(The above PC connection cable may be used.)</p> <ul style="list-style-type: none"> • PROFIBUS transmission cable (with connectors at both ends)
---	---

See chapter 5 , 6 and section 9.2



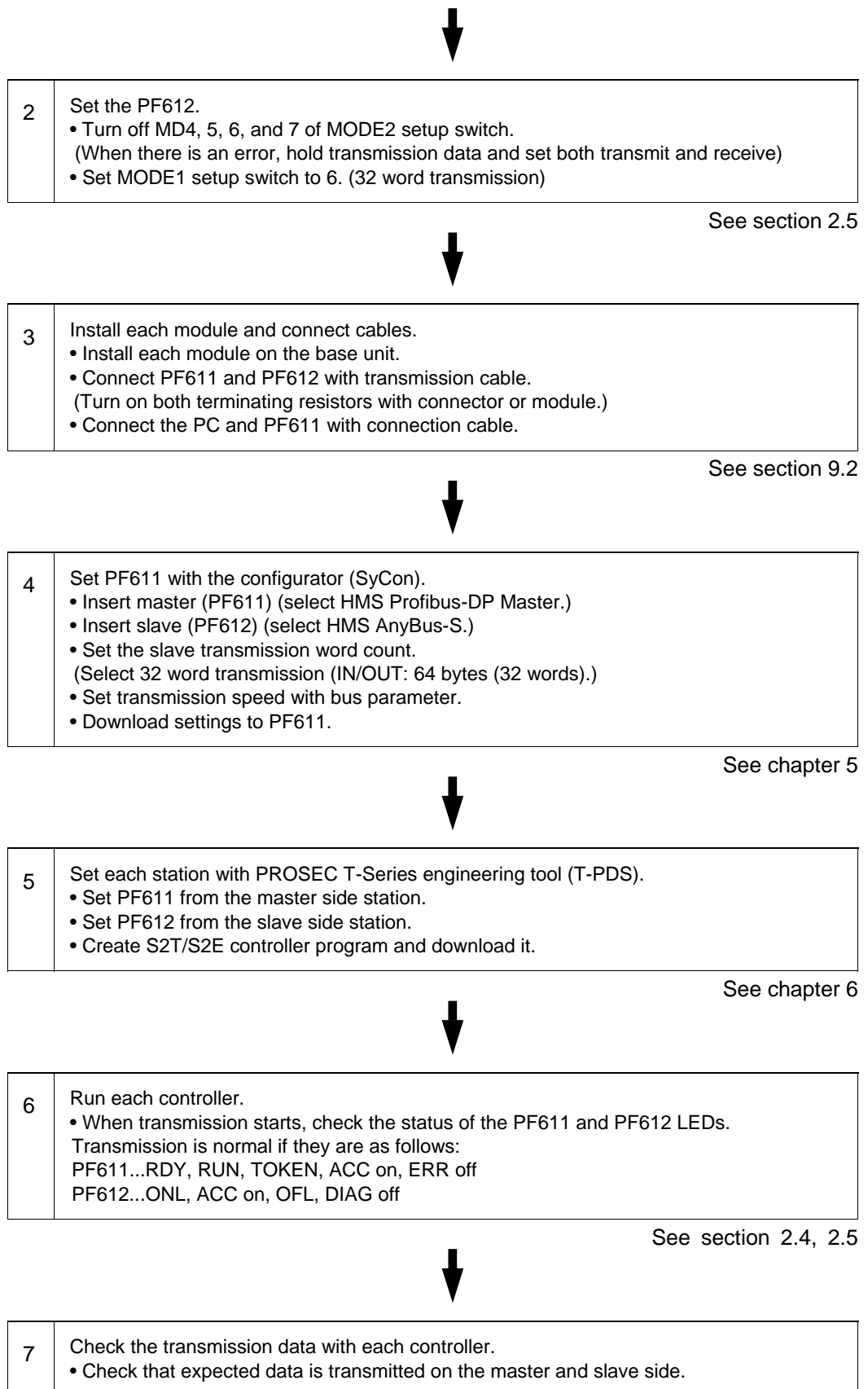

Figure 4-4 Startup procedure example

4.4 Application Program (Start Procedure)

It explains the PF611/PF612 start procedure by the application program. These requests are done by a special command for PF611/PF612.

Please refer to Chapter 8 for details.

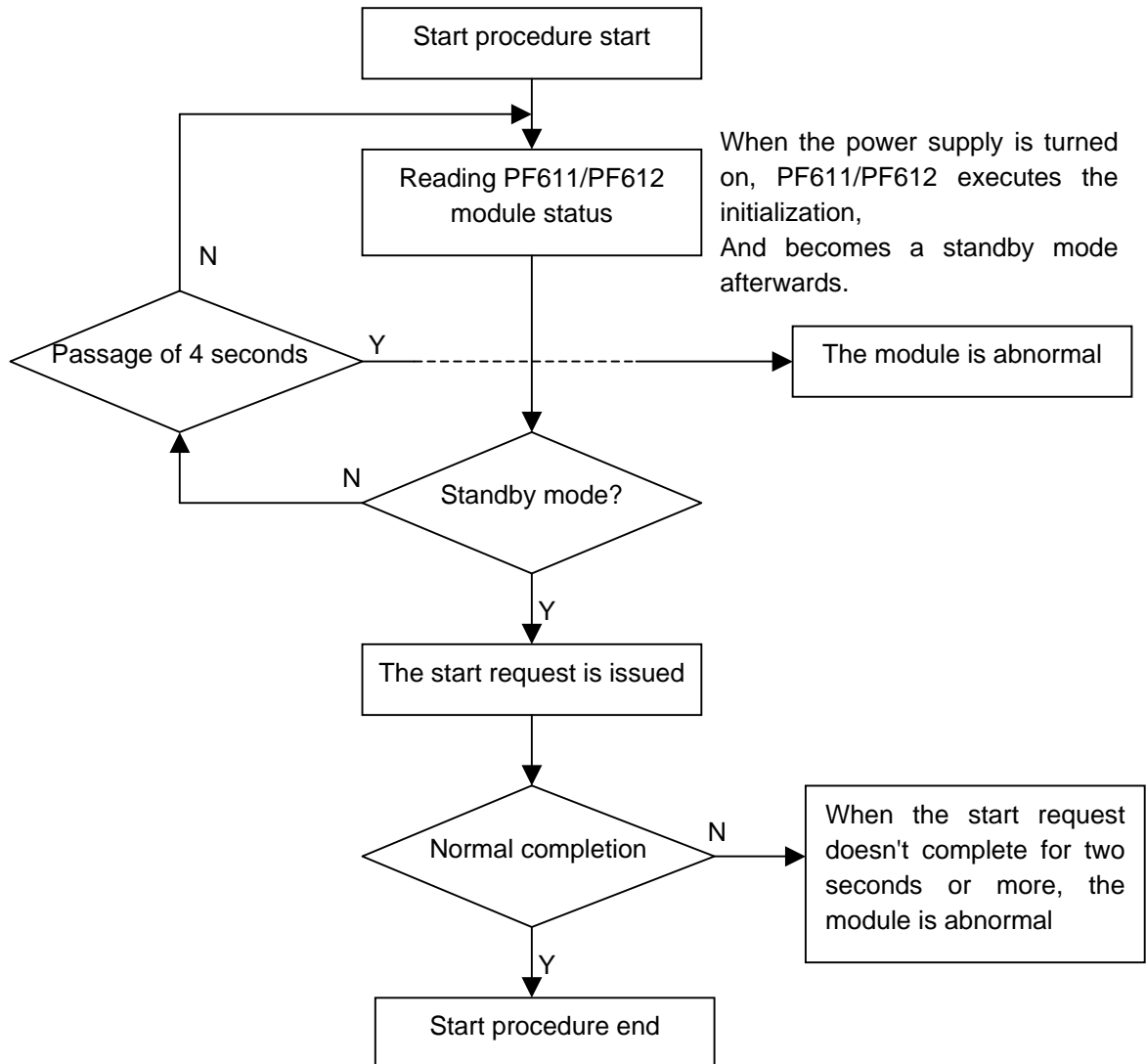

Figure 4-5 Application program example (Start procedure)

4.5 Access for PF611/PF612 Controller Interface Memory

This chapter explains the method of accessing the controller interface memory area of PF611/PF612 from the application program of S2T/S2E.

(1) Read data

(a) Instruction: special module data input instruction (READ instruction)

(b) Reading example

This is an example of reading one word from PF611 controller interface memory area (address 10), and storage in D register (D1665) of S2T/S2E.

PF611 is mounted on slot 5 of a basic unit.

```
| R0001 |
| - | | -+ [00010 MOV RW116] [00001 MOV RW117] ----- |
| | | /* Read address and read word number */ |
| + [H0005 READ RW116 -> D1665] [RST R0001] ----- |
| /* READ instruction execution, R0001 clear */ |
```

Explanation

H0005: Slot 5 of a basic unit that is the position where PF611/PF612 is mounted is shown.

Two high rank digits show the specification of the unit and two subordinate position digits show the slot position.

Therefore, "H0103" becomes for slot 3 of enhancing unit 1.

RW116: Read address (00010) of PF611 controller interface memory is specified.

RW117: "One word" is specified.

D1665: It is a register that stores the data read from PF611.

R0001: It is a start condition of this READ instruction.

(2) Write data

(a) Instruction: special module data output instruction (WRITE instruction)

(b) Write example

This is an example of sequentially writing the 16 words data from "D0080 – D0095" of S2T/S2E to PF611 controller interface memory area (address 256).

PF611 is mounted on slot 5 of a basic unit.

```
| R0002 |
| - | | -+ [00256 MOV RW104] [00016 MOV RW105] ----- |
| | | /* Writing address and writing word number */ |
| + [D0080 WRITE RW104 -> H0005] [RST R0002] ----- |
| /* WRITE instruction execution, R0002 clear */ |
```

Explanation

H0005: Slot 5 of a basic unit that is the position where PF611/PF612 is mounted is shown.

Two high rank digits show the specification of the unit and two subordinate position digits show the slot position.

Therefore, "H0103" becomes for slot 3 of enhancing unit 1.

The PF module status is stored in "D1665" here.

RW104: Writing first memory address (00256) of PF611 controller interface memory is specified

Rw105: Number of words written in output area. 16 words are specified.

D0080: It is a storage register of the written data. The writing data of 16 words is stored from "D0080"

R0002: It is a start condition of this WRITE instruction.

Chapter 5 Transmission

Parameter Setup

5

When using this module, you must set the transmission parameters using the PROFIBUS configurator, in addition to the controller setup and registration.

Use the following PROFIBUS configurator:

Name:

PROFIBUS SYSTEM CONFIGURATOR

HMS SYCON

Manufacturer:

HMS INDUSTRIAL NETWORKS AB

Supported OS:

Windows95, Windows98, WindowsNT4.0 with Service Pack3 or higher, Windows2000

The basic setup procedure is described below. Refer to the manuals for the above configurator for more information.

- Start HMS SyCon.
- Select [File]-[New] to create a new file, open the busline window and enter the configuration mode.
- Add masters on the bus. (Select Profibus-DP Master provided by HMS for PF611.)
- Add a slave and assign it to a master. (Select AnyBus-S provided by HMS for PF612.)
- Set the I/O modules and parameters for the added slave.
- Select a master to check the attributes and connection between devices and then check other masters to verify the setting.
- Select the baud rate and bus parameters.
- Set how HMS SyCon and master should communicate.
- Save the settings.
- Select the port to download to the master and download.
- Connect the PROFIBUS cable between devices. Enter debug mode to check the communication status and perform I/O monitor test.
- Print out the documents of the set PROFIBUS system.
- When PROFIBUS runs normally, install the applications.

Chapter 6 Operation Mode

This chapter describes the PF611/PF612 operation mode and mode transition.

6.1 Operation mode

Table 6-1 Operation mode

Operation mode	Explanation
Initialize mode	<p>(a) Initializing hardware and software of PF611/PF612. When the power supply is turned on, it becomes this mode. When the reset request is issued from S2T/S2E, it becomes this mode.</p> <p>(b) This mode continues for about one second, and shifts to the standby mode afterwards.</p> <p>(c) PF611/PF612 doesn't transmit in this mode.</p> <p>(d) A special request by S2T/S2E is not accepted.</p>
Standby mode	<p>(a) "Start request from S2T/S2E" waiting mode.</p> <p>(b) When the controller is stop 'HALT' or 'ERROR', it becomes this mode. The PF311/312 module is normal but transmission stop.</p> <p>(c) The PF module status: bit 12 is set .</p>
Transmission beginning waiting mode	<p>(a) Waiting for the transmission beginning between master and slave though "Start request from S2T/S2E" was accepted.</p> <p>(b) It shifts to an online mode when beginning to transmit.</p> <p>(c) The PF module status: bit 13 is set.</p>
Online mode	<p>(a) State of normal transmission.</p> <p>(b) The PF module status: bit 15 is set.</p>
Down mode	<p>(a) PF311/312 stopped detecting error. It doesn't return automatically when entering this mode.</p> <p>(b) The module exchange is necessary when not returning even if the power supply the re-turning on is repeated.</p> <p>(c) Down information is stored in RAS information area, the down factor can be confirmed.</p> <p>(d) The PF module status: 12 and 13 bits are set.</p>

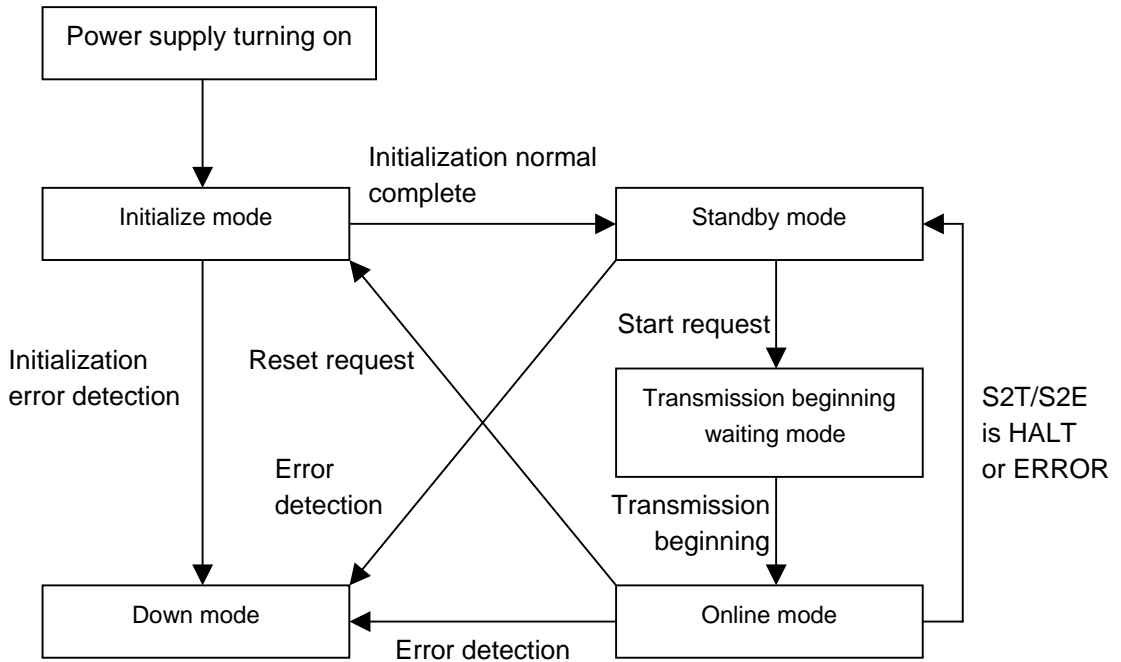

Figure 6-1 Operation mode transition

Chapter 7 Module Control

This chapter explains the interface memory area of PF611/PF612 seen from S2T/S2E application program.

PF611/PF612 allocates the sending and receiving data of the cyclic transmission to this memory area. Also, the request/response text area between S2T/S2E and PF611/PF612 is allocated on this memory area.

S2T/S2E application program accesses this memory area directly by READ/WRITE instruction.

7.1 Controller Interface Memory Map

(1) PF611 memory map

Table 7-1 Controller interface memory map

Address	Name	Function
000h-0FFh	PF module information (256 words)	PF module status, control information
100h-1FFh	Write data (256 words)	Output area to PF611
200h-2FFh	Read data (256 words)	Input area from PF611
300h-47Fh	Reserved	Do not use
480h-50Fh	Request text area (288 bytes)	Storage area for request text passed from S2T/S2E to PF611
510h-58Fh	Unused	Do not use
590h-61Fh	Response text area 288 bytes	Storage area for response text passed from PF611 to S2T/S2E
620h-69Fh	Unused	Do not use
6A0h-6FFh	Reserved	Do not use
700h-7C7h	DP system information (400 bytes)	Transmission module DPRAM system information
7C8h-7CDh	DP firmware information (12 bytes)	Transmission module DPRAM firmware information
7CEh-7EFh	Reserved	Do not use
7F0h-7FBh	Semaphore area (32 bytes)	Semaphore for data exchange between S2T/S2E and PF611
7FCh-1FFBh	Reserved	Do not use
1FFCh-1FFDh	PF control register	Request register from S2T/S2E to PF611
1FFEh-1FFFh	CNT control register	Notification register from PF611 to S2T/S2E

The address is the offset address (word address) from the beginning of the PF611 interface memory.

(2) PF612 memory map

Table 7-2 PF612 controller interface memory map

Address	Name	Function
000h-0FFh	PF module information (256 words)	PF module status, control information
100h-179h	Write data (122 words)	Output area to PF612
17Ah-1FFh	Unused	Do not use
200h-279h	Read data (122 words)	Input area from PF612
27Ah-17FFh	Unused	Do not use

The address is the offset address (word address) from the beginning of the PF612 interface memory.

7.2 Module Control Information

The information to control the PF611 or PF612 module is shown below.

Table 7-3 Module control information (PF611)

Address	15	0
0040h	PF module control enable flag (1W)	
0041h	PF module control code (1W)	

Table 7-4 Module control information (PF612)

Address	15	0
0040h	PF module control enable flag (1W)	
0041h	PF module control code (1W)	
0042h	PF612 transmit word count (1W)	
0043h	PF612 receive word count (1W)	
0044h	PF612 transmission word count setup request acknowledge result (1W)	

The address is the offset address (word address) from the beginning of the PF611 or PF612 interface memory.

(1) PF module control enable flag

A5A5h → Module control enabled
 Not A5A5h → Module control disabled

(2) PF module control code

0001h → Reset PF module
 0002h → Activate PF module
 0003h → PF612 transmission word count setup (valid only for PF612)

(3) PF612 transmit word count

Specify the transmit word count between 1 and 122 words (the sum of (3) and (4) must not exceed 208 words)

(4) PF 612 receive word count

Specify the receive word count between 1 and 122 words (the sum of (3) and (4) must not exceed 208 words)

(5) PF612 transmission word count setup request acknowledge result

0001h → Successfully acknowledged
 0002h → Setup content error detected

7.3 Reset PF Module

This code is used to reset the PF module from an application when the PF module aborts for some reason.

Refer to the PF module RAS information in the next chapter and perform the following procedure.

- (1) Check that the PF module Healthy counter is changed. (If it is not changed, this request is not accepted.)
- (2) Write 0001h in the PF module control code.
- (3) Write A5A5h in the PF module control enable flag.
- (4) After reset completes, check that the PF module status is STANDBY.

The PF module control enable flag and the PF module control code are cleared when the PF module processes this request.

7.4 Activate PF Module

7

This code is used to start PF module transmission.

Refer to the PF module RAS information in the next chapter and perform the following procedure.

- (1) Check that the PF module Healthy counter is changed. (If it is not changed, this request is not accepted.)
- (2) Write 0002h in the PF module control code.
- (3) Write A5A5h in the PF module control enable flag.
- (4) After reset completes, check that the PF module status is ONLINE.

The PF module control enable flag and the PF module control code are cleared when the PF module processes this request.

If resume transmission (resume transmission with 0 data or data prior to error occurrence) is selected for PF module operation setting when there is a controller error, activate PF module request is ignored and transmission is started when controller error is resolved.

7.5 PF612 Transmission Word Count Setup

This procedure is used to set the PF612 module transmission word count.

It is valid only when setup from the controller is selected with the MODE2 setup switch (MD7, MD6=ON, ON).

- (1) Check that the PF module Healthy counter is changed. (If it is not changed, this request is not accepted.)
- (2) Write 0003h in the PF module control code.
- (3) Write a value between 1 and 122 in PF612 transmit word count. (Note that the sum of (3) and (4) must not exceed 208)
- (4) Write a value between 1 and 122 in PF612 receive word count. (Note that the sum of (3) and (4) must not exceed 208)
- (5) Write A5A5h in the PF module control enable flag.
- (6) Check that the PF612 transmission word count setup request acknowledge result is 1 to confirm the end of setup.

The PF module control enable flag and the PF module control code are cleared when the PF module processes this request.

This request is accepted only once after a power on or PF module reset. If this request ends abnormally, turn on the power or reset the PF module once more and set the correct transmission word count.

Chapter 8 RAS Information

8.1 PF611 RAS Information

PF611 RAS information is referenced with READ instruction.

Table 8-1 PF611 RAS Information

Address	15	0
0000h	PF module status (1W)	
0001h	Healthy counter (1W)	
0002h	Device error (1W)	
0010h	PROFIBUS-DP status (32W)	

The address is the offset address (word address) from the beginning of the PF611 interface memory.

(1) PF module status

Indicates the status of the modules installed on the local unit.

Table 8-2 PF module status

	F	E	D	C	B	A	9	8	7	6	5	4	3	2	1	0
0000h	ONL		PF_MODE				DV_STS	DVER		NPR	TXER		NDT	ACL	CNT	

ONL (ON LINE) → 1: PF module is online 0: Not online

PF_MODE (PF_MODE) → 00: PF module is online
01: PF is standby
10: PF module is not operating
11: PF is down

DV_STS (DV_STS) → 00: Transmission module is offline
01: Transmission module is stopped
10: Transmission module is cleared
11: Transmission module is operating

DVER (DEV_ERR) → 1: Transmission module error 0: Operating normally

NPR (NO_PARA) → 1: No activation request 0: Activation request

TXER (TX_ERR) → 1: Transmission error 0: Operating normally

NDT (No data) → 1: Slave stopped 0: Operating normally

ACL (Auto clear) → 1: Auto clear mode 0: Operating normally

CNT (Control) → 1: Parameter error 0: Operating normally

(2) Healthy counter

Indicates the normal operating status of the PF module.

Table 8-3 Healthy counter

	F	E	D	C	B	A	9	8	7	6	5	4	3	2	1	0
0001h	Healthy Counter															

Indicates that the PF module is operating normally. A 16-bit counter that is updated every 100 ms.

Returns to 0 after FFFFh.

(3) Device error

Indicates the transmission module error status.

	F	E	D	C	B	A	9	8	7	6	5	4	3	2	1	0
0002h	Device Error															

The error status is indicated with the following codes:

Table 8-4 Device error

Error No.	Symbol	Description
0	-	No error
14		OS module, firmware download in progress
50	RAM_TEST	RAM check error
53	FLASH_TEST	FLASH PROM checksum error
100-107	SYSTEM	Internal system error
200	Unknown_IRQ	Unknown interrupt detected
201	Watchdog	Watchdog timer error
202	TX_IRQ	Unknown send interrupt from serial channel detected
203	RX_IRQ	Unknown receive interrupt from serial channel detected
252	Download active	Firmware or database download in progress
253	Bootloader active	Bootstrap loader activeFirmware stopped

(4) PROFIBUS-DP status

Indicates the transmission module operating status.

Table 8-5 PROFIBUS-DP status

Address	15	0
0010h	Master status	Global error bit
0011h	Error event	Error causing remote address
0012h	Bus error counter	
0013h	Timeout counter	
0018h	Slave setting status (bit for each slave)	
0020h	Slave operating status (bit for each slave)	
0028h	Slave diagnostic (bit for each slave)	

(a) Global error bit

Indicates the PF module internal transmission control error status.

Table 8-6 Global error bit

7	6	5	4	3	2	1	0
Reserved(0)				No data	Auto clear	Control	

- No data → 1: 1 or more remote node is not exchanging data or is in error
0: Operating normally
- Auto clear → 1: Running in auto clear mode due to remote node error
0: Operating normally
- Control → 1: Parameter error occurred
0: Operating normally

(b) Master state

7	6	5	4	3	2	1	0
Master state							

Table 8-7 Master state

Value	Name	State
00h	OFFLINE	Offline
40h	STOP	Data transmission with slave stopped
80h	CLEAR	Input information from slave is read, but output is cleared or retained
C0h	OPERATE	Cyclic data I/O is performed

(c) Error remote address

Table 8-8 Error remote address

7	6	5	4	3	2	1	0
Err_Rem_Addr							

- 00h to FEh → Lowest no. of slave node which has an error
- FFh → Master module internal error

(d) Error event

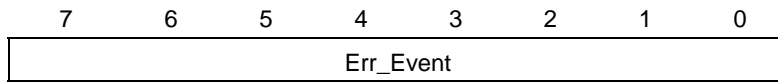
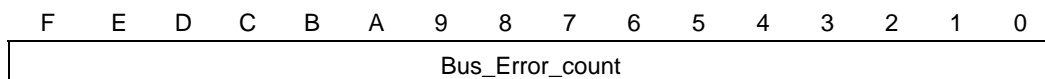

Table 8-9 Error events

Value	Error Event	Cause	Action
0	Remote node operating normally		
3	Remote node internal function invalid	Remote	Check the setting and use correct GSD file
9	No response for data	Remote	Re-examine bus cable
17	No response from slave	Remote	Re-examine bus cable and re-examine remote node address
18	Master not participating in token ring	Master	Re-examine master node address
50-53	Internal error	Master	Contact Toshiba
54	No master parameter	Master	Download setup information again
55	Master parameter error	System design	Contact Toshiba
56	No remote node parameter	System design	Download setup information again
57	No remote node parameter	System design	Contact Toshiba
58	Duplicate remote node address	System design	Re-examine remote node address
59	Transmit address out of range	System design	Re-examine transmit address
60	Receive address out of range	System design	Re-examine receive address
61	Duplicate receive area	System design	Re-examine receive address
62	Duplicate transmit area	System design	Re-examine transmit address
202	Insufficient space	Master	Contact Toshiba
212	Setup data read error	Master	Download setup information once more
213	System error	Master	Contact Toshiba
Others	Unprescribed error	-	Contact Toshiba

(e) Bus error counter

Table 8-10 Bus error counter



Severe bus error counter

(f) Timeout counter

Table 8-11 Timeout counter

F	E	D	C	B	A	9	8	7	6	5	4	3	2	1	0
Time_out_count															

PROFIBUS telegram exclusion count

One reason for incrementing the counter might be bus cable short.

(g) Slave setup state

Table 8-12 Slave setup states

	F	E	D	C	B	A	9	8	7	6	5	4	3	2	1	0
0018h	15	14	13	12	11	10	9	8	7	6	5	4	3	2	1	0
:																
001Fh	-	126	125	124	123	122	121	120	119	118	117	116	115	114	113	112

The numbers in the above table are node numbers.

0 → Remote node not set

1 → Remote node set

(h) Slave operating state

Table 8-13 Slave operation states

	F	E	D	C	B	A	9	8	7	6	5	4	3	2	1	0
0020h	15	14	13	12	11	10	9	8	7	6	5	4	3	2	1	0
:																
0027h	-	126	125	124	123	122	121	120	119	118	117	116	115	114	113	112

The numbers in the above table are node numbers.

0 → No remote node or remote node stopped

1 → Remote node operating

(i) Slave diagnostic

Table 8-14 Slave diagnostic

	F	E	D	C	B	A	9	8	7	6	5	4	3	2	1	0
0028h	15	14	13	12	11	10	9	8	7	6	5	4	3	2	1	0
:																
002Fh	-	126	125	124	123	122	121	120	119	118	117	116	115	114	113	112

The numbers in the above table are node numbers.

0 → No new diagnostic information

1 → New diagnostic information

8.2 PF611 DP system Information

PF611 DP system information is referenced with READ instruction.

Table 8-15 PF611 DP system Information

Address	15	0
0700h	Firmware name (8W)	
0708h	Firmware version (8W)	
07CBh	Data exchange mode	Master recognition
07CCh	Device type	DPM size
07CDh	Reserved	Field bus type

(1) Firmware name

The firmware name is specified as text string.

Table 8-16 Firmware name

Hex dump	Character
44 50 4D 20 20 20 20 20	DPM
48 4D 53 2D 44 50 4D 20	HMS-DPM

(2) Firmware version

The firmware version is specified as text string.

Table 8-17 Firmware version

Hex dump	Character
56 30 31 2E 30 30 30 20	V01.000
30 34 2E 30 36 2E 39 37	04.06.97

(3) Master recognition

Table 8-18 Master recognition

7	6	5	4	3	2	1	0
Master recognition							

- 0 → Master module
- Non-zero → Slave module

(4) Data exchange mode

Table 8-19 Data exchange mode

7	6	5	4	3	2	1	0
Data Exchange Mode							

- 1xh → Bus synchronous, device controlled
 2xh → Bus asynchronous, device controlled
 3xh → Standard, uncontrolled
 4xh → Bus asynchronous, host controlled
 5xh → Bus synchronous, host controlled
 Set to 5xh for PF611 module.

(5) DPM size

Table 8-20 DPM size

7	6	5	4	3	2	1	0
DPM Size							

- 02h → 2 KB DPRAM is installed

(6) Device type

Table 8-21 Device error

7	6	5	4	3	2	1	0
Device Type							

- 34h → PROFIBUS master

(7) Fieldbus type

Table 8-22 Fieldbus type

7	6	5	4	3	2	1	0
FB Type							

- 31h → 8 bit PROFIBUS-DP master

(8) Reserved

Table 8-23 Reserved

7	6	5	4	3	2	1	0
Reserved							

- 48h → "H"-HMS Fieldbus system

8.3 PF612 RAS information

PF612 RAS information is referenced with READ instruction.

Table 8-24 PF612 RAS information

Address	15	0
0000h	PF module status (1W)	
0001h	Healthy counter (1W)	

The address is the offset address (word address) from the beginning of the PF612 interface memory.

(1) PF module status

Indicates the status of the modules installed on the local unit.

Table 8-25 PF module status

	F	E	D	C	B	A	9	8	7	6	5	4	3	2	1	0
0000h	ONL		PF_MODE							NPR						

- ONL (ON LINE) → 1 : PF module is online 0: Not online
- PF_MODE (PF_MODE) → 00: PF module is online
01: PF is standby
10: PF module is not operating
11: PF is down
- NPR (NO_PARA) → 1: No activation request 0: Activation request

(2) Healthy counter

Indicates the normal operating status of the PF module.

Table 8-26 Healthy counter

	F	E	D	C	B	A	9	8	7	6	5	4	3	2	1	0
0001h	Healthy Counter															

Indicates that the PF module is operating normally. A 16-bit counter that is updated every 100 ms.

Returns to 0 after FFFFh.

Chapter 9 Appendix

9.1 Error Inspection

(1) PF611 LED status

The station mode is indicated as follows with the RDY, RUN, TOKEN, ERR, and ACC LEDs on the front of the module.

Table 9-1 PF611 LED status

LED		Status and Cause
RDY (green)	ON	Transmission module normal
	Cyclic flash (1 Hz)	Firmware not stored
	Cyclic flash (4 Hz)	Hardware error or system error or in downloading firmware configuration data
	OFF	Hardware failure
RUN (green)	ON	Communicating
	Cyclic flash (4 Hz)	Standby
	Acyclic flash	Configuration error or fatal error
TOKEN (green)	ON	Token retained
	OFF	No token
ERR (red)	ON	Error on communication line
	OFF	No error detected
ACC(green)	ON	Controller accessing
	OFF	Controller not accessing

The acyclic flashing pattern is as follows. If the error is not resolved after repeatedly downloading configuration parameters from the configurator, please contact Toshiba.



(2) PF612 LED status

The station mode is indicated as follows with the ONL, OFL, DIAG, and ACC LEDs on the front of the module.

Table 9-2 PF612 LED status

LED		Status and Cause
ONL (green)	ON	Transmission module communicating normally
	OFF	Transmission module not communicating
OFL (red)	ON	Transmission module not communicating
	OFF	Transmission module other than not communicating
	Acyclic flash	Configuration error or fatal error
DIAG (red)	Cyclic flash (1 Hz)	Setup (configuration information) error
	Cyclic flash (2 Hz)	Setup (user parameter) error
	Cyclic flash (4 Hz)	Profibus ASIC initialization error
	OFF	No diagnostic information
ACC (green)	ON	Controller accessing
	OFF	Controller not accessing

(3) Configurator diagnostic information

The following diagnostic information can be checked using HMS SYCON.

Refer to the configurator manual for more details.

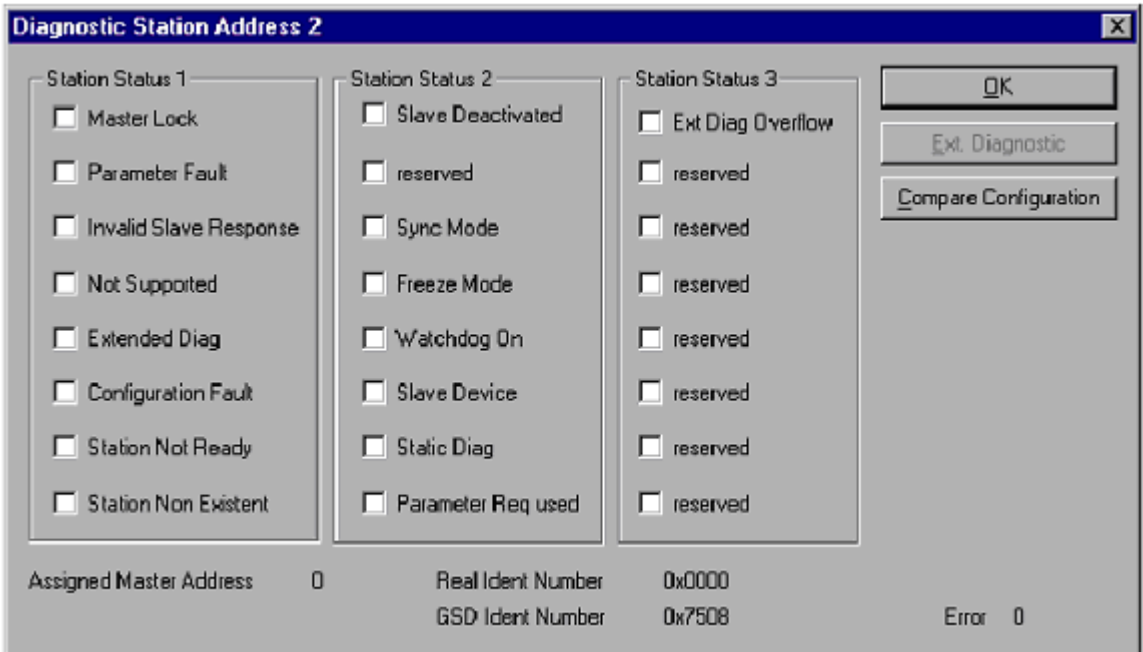

Figure 9-1 Configurator diagnostic information

(4) Periodic check

Please execute the following check by units of 1 month or several months.

Table 9-2 Periodic check item

Check item	Method	Judgment condition	Processing in abnormal circumstances
State of wiring of cable	Watching	Is the fixation of the cable loose? Does the weight of the cable hang in the connector?	The cable is fixed by clamping.
Loosening of connector	Watching	Is there loosening in the connector uniting part of the cable?	It tries to tighten the connector. (note)
Grounding check	Watching	Is there loosening in parts such as the screws?	Trying tightening such as screws.
Module ventilation hole	Watching	Is there stopped up with garbage?	Cleaning

9.2 Installing modules and Transmission Cable

(1) Installing modules

- (a) Please turn off power when removing any units, modules, terminal blocks or wired cables after installing. Otherwise it can cause failure, malfunction or electrical shock.
- (b) The PF611/PF612 module is mounted on the I/O bus slot.
The procedure of mounting the module is the same as the G2-I/O module.
- (c) The transmission cable is connected.

(2) Detaching modules

- (a) Please detach the PF611/PF612 module in order opposite to the installation after it turns off power.

(3) Transmission cable

Twisted pair cable connection and accessories

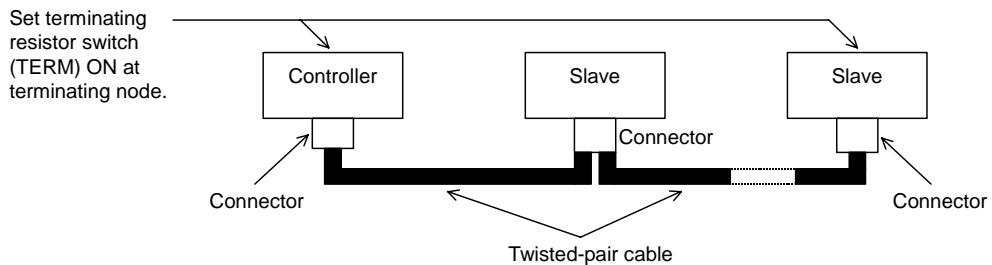

Figure 9-2 Transmission cable

Table 9-3 Transmission path accessories

Name	Type/Rating	Usage	Manufacturer (recommended)
Twisted pair cable	6XV1-830-0EH10	PROFIBUS standard cable	Siemens
Connector	6GK1 500-0FC00/-0EA02	Master module connector (with built-in terminating resistor)	Siemens

There are also PROFIBUS repeaters (electrical and optical), but PROFIBUS compatible manufacturer products should be used.

Refer to the following the PROFIBUS Association web page for the supported products.

<http://www.profibus.com/>

WARNING

The recommended connector has a built-in terminating resistor. The master module and slave module also have built-in terminating resistors. Do not turn ON both terminating resistors at the same time.

Normal transmission is not possible if they are turned ON at the same time.

CAUTION

When routing transmission cable where noise condition is poor, device error may occur due to noise. Installing the following ferrite core to the connector may improve the situation in this case.

Product no.: E04SR200935A Manufacturer: Seiwa Electric Mfg. Co., Ltd.

9.3 Connectors

(1) Configurator connector (only PF611)

Table 9-6 Configurator connector

Pin	I/O	Signal name	Description
1	-	-	-
2	INPUT	RXD	Receive data
3	OUTPUT	TXD	Transmit data
4	OUTPUT	DTR	Data terminal ready
5	Ref.	GND	Ground
6	-	-	-
7	OUTPUT	RTS	Request to send
8	INPUT	CTS	Clear to send
9	-	-	-
Case		PE	Protective ground

(2) PROFIBUS-DP connector

Table 9-7 PROFIBUS-DP connector

Pin	Signal name	Description
1	Shield	Cable shield
2	-	
3	B-Line	Bus data (B)
4	RTS(TTL)	Repeater control
5	GND Bus	Bus ground
6	+5V Bus	Bus +5V
7	-	-
8	A-Line	Bus data (A)
9	-	-
Case	Shield	Cable shield

9.4 Sample Application Programs (T-PDS)

(1) Sample program of PF611

In this sample program, PF611 is mounted on basic unit and slot 1 of S2T/S2E.

Sample program issues the start request to PF611, writes increment data in “Write data” area, reads from “Read data” area, and compares both data.

This program is registered in S2T/S2E. The program moves when S2T/S2E move to RUN mode.

	Main program	Block 1	
1	[W0000 TINZ(0031)W0001]	[00002 TON T000]	prepare send data wait for 20ms
2	[00000 MOV D1000]	[00001 MOV D1001]	circuit 2-6 PF611 start request
3	[H0001 READ D1000 -> D1100]		
	/* read PF611 module status */		
4	[D1100 AND HF000 -> D1100]	[D1100 = 04096]	
	/* module status = standby? */		
5	[00065 MOV D1000]	[00001 MOV D1001]	
	[D1002 WRITE D1000 -> H0001]		
	/* PF611 start request */		
	[00064 MOV D1000]	[00001 MOV D1001]	
	[D1002 WRITE D1000 -> H0001]	[SET R0502]	
	/* module control enable */		
6	[00030 TON T100]		
	/* wait for 3 seconds */		
7	[00512 MOV D1000]	[00032 MOV D1001]	circuit7-12 compare data
8	[H0001 READ D1000 -> W0512]		
	/* read receive data (32words) */		
9	[00256 MOV D1000]	[00032 MOV D1001]	
10	[W0000 WRITE D1000 -> H0001]		
	/* write send data (32 words) */		
11	[W0000 TCMP (32) W0512 -> D1200]	[+1 D1300]	
	[+1 W0000]		
	/* compare send data and receive data */		
12	[W0000 MOV YW000]	[D1300 MOV YW001]	
	/* compare error counter (W0000) copy to YW001 */		
13	[END]		

Figure 9-3 Sample program of PF611

(2) Sample program of PF612

In this sample program, PF612 is mounted on basic unit and slot 7 of S2T/S2E.

Sample program issues the start request to PF612, reads from "Read data" area, and writes that data in "Write data" area.

This program is registered in S2T/S2E. The program moves when S2T/S2E move to RUN mode.

	Main program	Block 1
1	[00000 MOV D1000][00001 MOV D1001]-----	circuit 1-4 PF612 start request
2	[H0007 READ D1000 -> D1110]----- /* read PF611 module status */	
3	[D1110 AND HF000 -> D1110][D1110 = 04096]----- /* module status = standby? */	R0502 ()
4	- -+ [00065 MOV D1000][00001 MOV D1001][00002 MOV D1002]----- + [D1002 WRITE D1000 -> H0007]----- /* PF611 start request */ + [00064 MOV D1000][00001 MOV D1001][-23131 MOV D1002]----- + [D1002 WRITE D1000 -> H0007]----- /* module control enable */	
5	[00512 MOV D1000][00122 MOV D1001]-----	circuit 5-8 received data move to "Write data" area
6	[H0007 READ D1000 -> W0256]----- /* read all "Read data" area */	
7	[00256 MOV D1002][00122 MOV D1003]-----	
8	[W0256 WRITE D1002 -> H0007]----- /* The read data is written in "Write data" area as it is */	
9	[END]-----	

Figure 9-4 Sample program of PF612

Integrated Controller Vseries
model 2000 PROFIBUS Module User's Manual for S2T/S2E

1st edition

24 March, 2006

1147.1.0603

TOSHIBA CORPORATION

INDUSTRIAL AND POWER SYSTEMS & SERVICES COMPANY

Electrical Apparatus & Measurement Division

Overseas Sales & Marketing Department - Group 3 TEL.: +81-3-3457-4894

1-1, Shibaura 1-chome, Minato-ku, Tokyo 105-8001, Japan

Microelectronics & System Components Department

- System Components Support Group TEL.: +81-42-333-2192

1, Toshiba-cho, Fuchu-shi, Tokyo 183-8511, Japan

© TOSHIBA Corporation 2005-2006

All Right Reserved.

Integrated Controller **V** series

PROFIBUS Module User's Manual for S2T/S2E