

TOSVERT VF-PS1 / VF-FS1 series
LONWORKS[®] option unit
Communication Function Manual



NOTICE

1. Read this manual before installing or operating the LONWORKS option unit. Keep it in a safe place for reference.
2. All information contained in this manual are subject to change without notice. Please confirm the latest information on the web site "www.inverter.co.jp".

Introduction

Thank you for purchasing the “LONWORKS option unit” for TOSVERT VF-PS1 / VF-FS1 series inverter.
 Before using LONWORKS option unit, carefully read this function manual in order to completely and correctly utilize its excellent performance.



After reading this function manual, please keep it handy for future reference.

For details of its general handling, see an instruction manual attached with the option unit.





* Echelon®, LONWORKS®, LONMARK®, LonTalk®, Neuron®, are the registered trademarks or the trademarks of Echelon Corporation in the USA and other countries.

* LONMARK and the LONMARK Logo are managed, granted, and used by LONMARK International under a license granted by Echelon Corporation.

■ Handling in general

 Danger	
 Prohibited	▼ Do not connect or disconnect a network cable while the inverter power is on. It may lead to electric shocks or fire.
 Mandatory	▼ See the instruction manual attached with the option unit for cautions the handling. Otherwise, it may lead to electric shocks, fire, injuries or damage to product.

■ Network control

 Danger	
 Prohibited	▼ Do not send the value out of the valid range to network variables. Otherwise, the motor may suddenly start/stop and that may result in injuries.
 Mandatory	▼ Use an additional safety device with your system to prevent a serious accident due to the network malfunctions. Usage without an additional safety device may cause an accident.
 Warning	
 Mandatory	▼ Set up “Communication error trip function (see below)” to stop the inverter when the option unit is deactivated by an unusual event such as tripping, an operating error, power outage, failure, etc. - Receive heart beat timer See the “nciRcvHrtBt (Receive Heartbeat Time)” for details. Deactivated option unit may cause an accident, if the “Communication error trip function” is not properly set up. ▼ Make sure that the operation signals are STOP before clearing the inverter fault. The motor may suddenly start and that may result in injuries.

■ Notes on operation

Notes	
	▼ When the control power is shut off by the instantaneous power failure, communication will be unavailable for a while. ▼ The Life of EEPROM is approximately 10000 times. Avoid writing data more than 10000 times to the same parameter of the inverter and configuration properties on LONWORKS option unit.

Table of Contents

1. Scope.....	4
1.1. Overview.....	4
1.2. Applicable model.....	4
1.3. System configuration.....	4
2. Names and functions of main parts.....	5
2.1. Outline view.....	5
2.1.1. LIU006Z (for VF-PS1).....	5
2.1.2. LIU007Z (for VF-FS1).....	5
2.2. Diagnostics.....	6
2.2.1. Service LED.....	6
2.2.2. Status LED.....	7
2.2.3. Fault LED.....	7
2.3. RS485 communication port.....	8
3. Configurations.....	9
3.1. Neuron ID.....	9
3.2. Service pin.....	9
3.3. Device interface (XIF) file.....	9
3.4. LNS Plug-in.....	9
3.5. Inverter configurations.....	9
3.6. Command & Setpoint selection (Local/Remote).....	10
3.7. Reference parameter of the inverter.....	11
4. Functional profile.....	12
4.1. Functional profile supported by this option.....	12
4.2. Object id.....	12
5. Node Object functional block.....	13
5.1. Object map.....	13
5.2. Network variables (Node Object).....	13
5.2.1. nciLocation (Location Label).....	14
5.2.2. nviRequest (Object Request).....	14
5.2.3. nvoStatus (Object Status).....	15
6. ACMotorDrive functional block.....	16
6.1. Object map.....	16
6.2. Network variable list (VSD_6010_11).....	17
6.3. Network variable list (the other).....	18
6.4. Configuration properties.....	19
6.4.1. nciMaxSpeed (Maximum Speed).....	19
6.4.2. nciMinSpeed (Minimum Speed).....	19
6.4.3. nciRcvHrtBt (Receive Heartbeat Time).....	20
6.4.4. nciSndHrtBt (Send Heartbeat Time).....	20
6.4.5. nciMinOutTm (Minimum Send Time).....	20
6.4.6. nciNmlSpeed (Nominal Motor Speed in min^{-1}).....	21
6.4.7. nciNmlFreq (Nominal Motor Frequency).....	21
6.4.8. nciRampUpTm (Ramp Up Time).....	21
6.4.9. nciRampDownTm (Ramp Down Time).....	22
6.4.10. nciDrvSpeedScale (Default value for nviDrvSpeedScale).....	22
6.4.11. nciPwUpOutTm (Power up delay time).....	22
6.5. Input network variables.....	23
6.5.1. nviDrvSpeedStpt (Drive Speed Setpoint).....	23
6.5.2. nviDrvSpeedScale (Drive Speed Setpoint Scaling).....	23
6.5.3. nviResetFault (Fault Reset Command).....	23
6.5.4. nviInvSetFreq (Frequency Setpoint).....	24
6.5.5. nviRelay1 /nviDigitalOut1,2 (Control of Digital Output).....	24
6.5.6. nviDigitalOutput (Control of All Digital Outputs).....	25
6.5.7. nviAnalogOut1,2 (Control of Analog output).....	25

6.5.8.	nviEmergOverride (Emergency stop)	26
6.5.9.	nviParamCmd (Parameter access)	26
6.6.	Output network variables	27
6.6.1.	Output network variable update	27
6.6.2.	nvoDrvCurnt (Drive Output Current)	27
6.6.3.	nvoDrvSpeed (Drive Speed Feedback)	27
6.6.4.	nvoDrvRunHours (Drive Total Running Hours)	27
6.6.5.	nvoInvOutFreq (Frequency Feedback)	27
6.6.6.	nvoDrvFeedback (Velocity Feedback)	28
6.6.7.	nvoStatusWord (Inverter Status)	28
6.6.8.	nvoDrvAlarm (Alarm)	28
6.6.9.	nvoAlarmWord (Alarm Status)	29
6.6.10.	nvoDrvThermal (Drive Thermal State)	29
6.6.11.	nvoMotorThermal (Motor Thermal State)	29
6.6.12.	nvoTorque (Motor Torque Monitor)	29
6.6.13.	nvoDrvEnergy (Cumulative Input Energy)	30
6.6.14.	nvoDigitalInput (All Digital Inputs Monitor)	30
6.6.15.	nvoDigitalIn1 to 8 (Digital Input Monitor)	30
6.6.16.	nvoAnalogIn1 to 3 (Analog Input Monitor)	31
6.6.17.	nvoEmergStatus (Emergency Status)	31
6.6.18.	nvoParamResp (Parameter Access Response)	32
6.6.19.	nvoTypeVer (Identification)	32
7.	Example usage	33
7.1.	Procedure	33
7.2.	Binding	33
7.3.	Option unit reset method	33
7.4.	Communication health management	34
7.5.	Parameter access method	35
8.	Specifications	37

1. Scope

1.1. Overview

LONWORKS technology is a network control system concept developed by Echelon Corporation, LONWORKS network provides Local Operating Network that is superior in the distributed control. it is featured by peer to peer communication between the LONWORKS nodes. This LONWORKS option is equipped with the LONWORKS Smart Transceiver (Neuron Chip) and LonTalk protocol in its firmware.

This network has following features.

1. Features the merit of distributed control. It enables to configure the network without Host computer.
2. The free topology wiring supported by the TP/FT-10 channel type accommodates bus, star, loop, or several combinations of these topologies.
3. Network construction tools are commercially available, and desirable network environment can be designed.
4. Products of the other manufacturer can also be laid out by open and non-exclusive network.

1.2. Applicable model

Applicable models are shown in the table below.

Part number of LONWORKS option unit	Applicable inverter model
LIU006Z	VF-PS1 series
LIU007Z	VF-FS1 series

1.3. System configuration

- Network configuration example

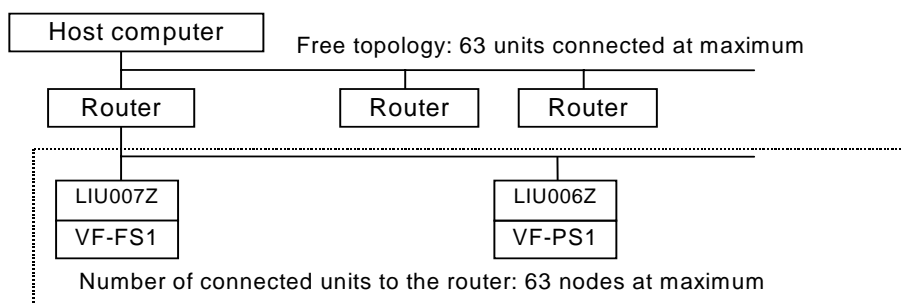

- The free topology wiring example

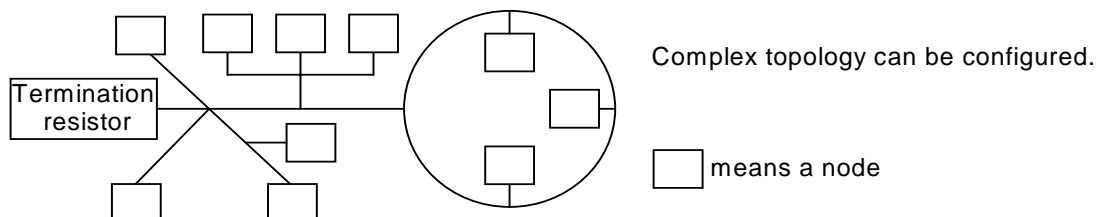

2. Names and functions of main parts

2.1. Outline view

The drawings below show names of main parts. Refer to each instruction manual for installing and wiring.

2.1.1. LIU006Z (for VF-PS1)

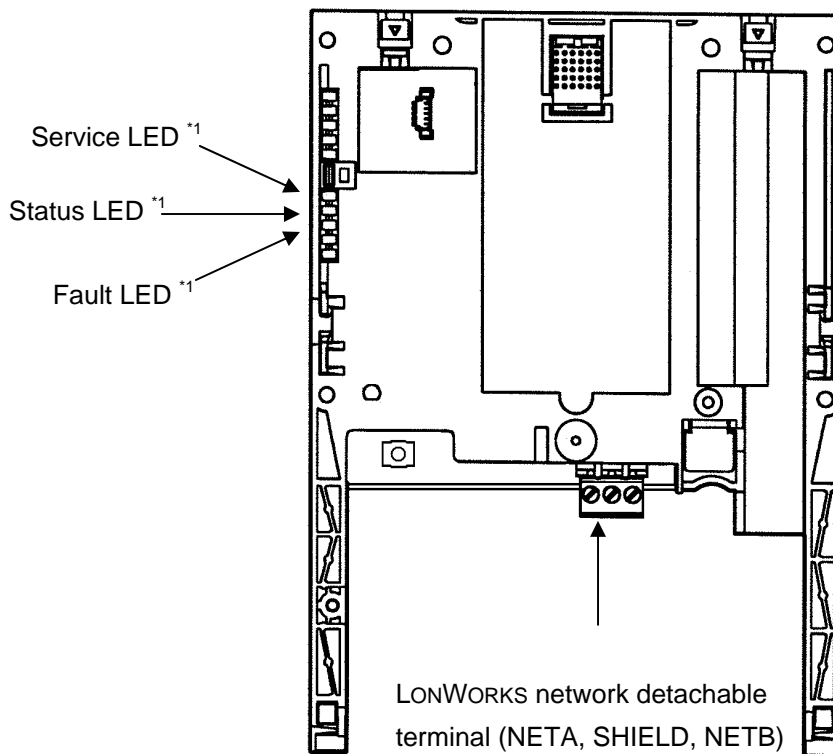

2.1.2. LIU007Z (for VF-FS1)

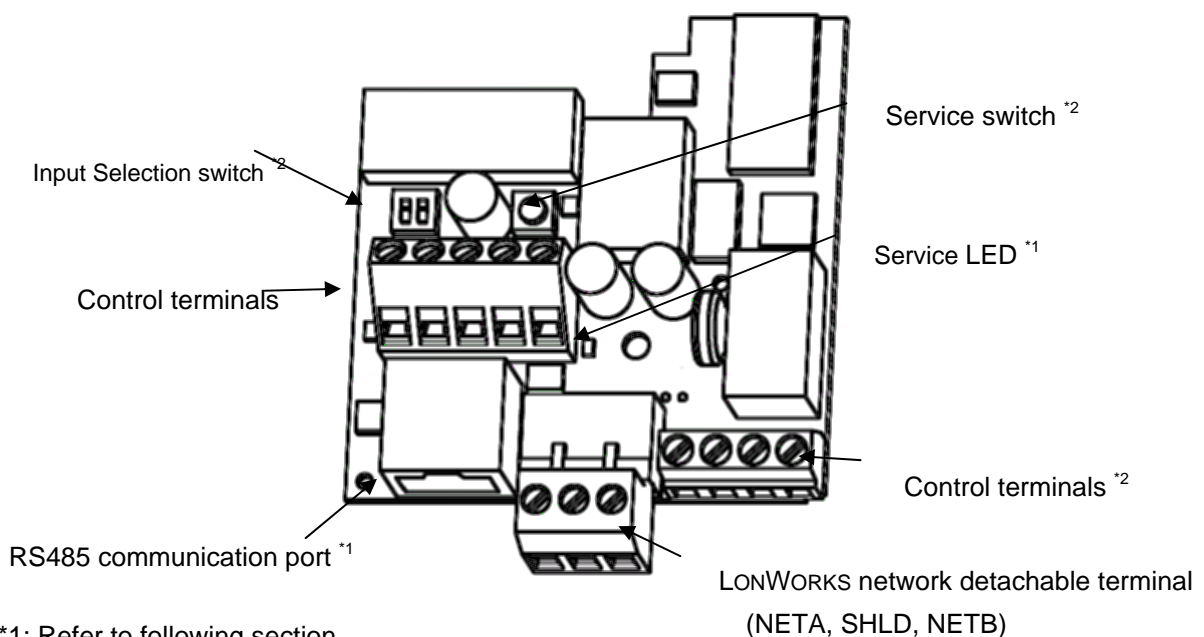

*1: Refer to following section.

*2: Refer to LIU007Z instruction manual (E6581371) for details.

2.2. Diagnostics

2.2.1. Service LED

Service LED indicates the node condition.

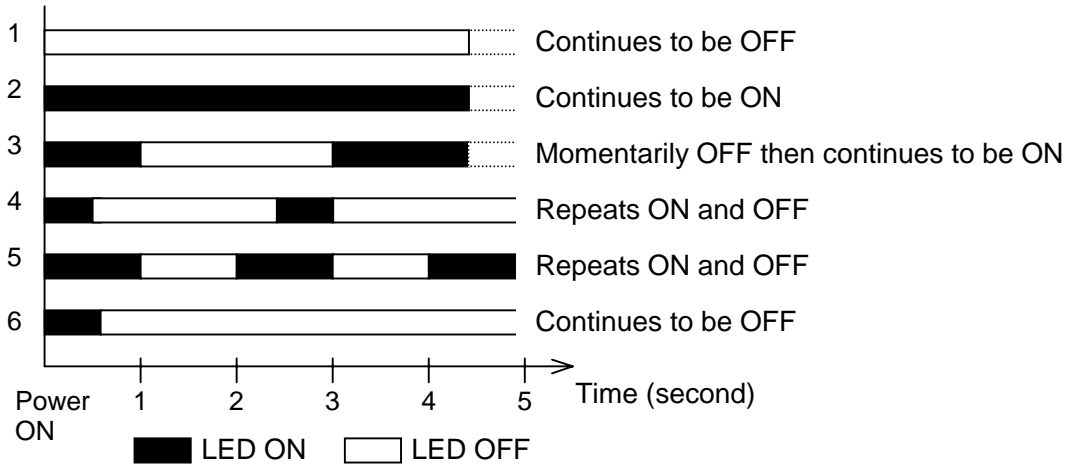

No	Phenomenon	Problem & Solutions
1	Although the inverter is turned on, LED remains OFF.	Check the connection between the inverter and the LONWORKS option unit. If abnormality is not found after checking, it needs to be repaired.
2	LED continues to be ON after the inverter is turned on.	
3	LED is ON then OFF when the inverter is turned on, and it continues to be ON.	Internal application program is abnormal. If the same indication appears after resetting the power, it needs to be repaired.
4	LED flashes every 0.5 second.	
5	LED flashes every 1 second.	This is a normal action of the "Unconfigured" device. If the device is not "Unconfigured", Internal application program is broken. It needs to be repaired.
6	LED momentarily turns ON then continues to be OFF.	When the program is in the condition of "Configures" status, LED momentarily turns ON when the inverter is turned on. Then the LED continues to be OFF for some seconds. The node indicates "Configured" status that means the normal condition.
-	Flicker of LED (Approximately 10Hz to 30Hz)	CPU is abnormal. It needs to be repaired.
-	LED turns ON while holding down service switch.	This is normal action while holding down service switch.

The phone numbers for a service call are listed on the back cover of the inverter instruction manual or on its catalog.

2.2.2. Status LED

It displays node status with green color. Only LIU006Z has this LED.

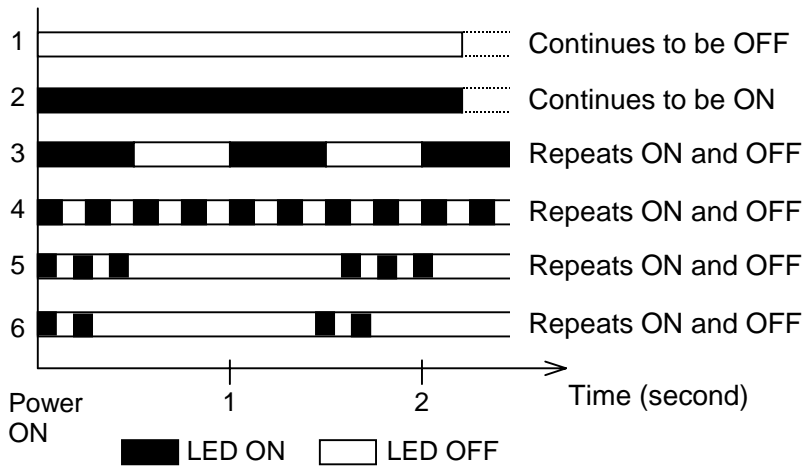

No	LED state	Description
1	Although the inverter is turned on, LED remains OFF.	No power
2	LED continues to be ON after the inverter is turned on.	The LONWORKS option unit is running in normal mode.
3	LED flashes every 1 second.	There is no connection to the LONWORKS network.
4	LED flashes every 0.25 second.	The LONWORKS option unit has received a Wink command. It continues for 30 second.
5	Repeats 3 flashing and OFF for 1 second.	These phenomenon occurs when the fault LED turning ON. CPU or Internal application program is abnormal. If the same indication appears after resetting the power, it needs to be repaired.
6	Repeats 2 flashing and OFF for 1 second.	

The phone numbers for a service call are listed on the back cover of the inverter instruction manual or on its catalog.

2.2.3. Fault LED

It displays fault with red color. Only LIU006Z has this LED.

LED state	Description
OFF	LONWORKS option unit has no fault.
ON	Hardware or software fault of the LONWORKS option unit
Flashing	The LONWORKS option unit does not communicate with the inverter. "E - 23" or "E - 24" error occurs. If the same indication appears after resetting the power, it needs to be repaired.

2.3. RS485 communication port

RS485 port is useful for RS485 serial communication option (USB001Z) or Remote Keypad (RKP002Z, RKP005Z). Refer to the inverter instruction manual for details.

N.B.: Caution for LIU007Z

When a RS485 port of LIU007Z is used for RS485 serial communication option, the communication option interrupts and disables the communication line between LONWORKS option unit and the inverter. At that time LONWORKS option unit propagates the abnormality as "Communication error (bit6)" in "nvoAlarmWord" and "nvoDrvAlarm" to the network. However, "Fault (bit0)" in "nvoStatusWord" is not set at that time. this is because identify difference between this alarm and Communication error trip (E r r 5). This abnormality will automatically cancel itself if the RS485 serial communication option is disconnected.

3. Configurations

3.1. Neuron ID

LONWORKS device has the individual Neuron ID. The ID is indicated on the option unit as the barcode. Products have 3 sticker labels where the Neuron ID is indicated.

3.2. Service pin

Service pin function causes the node to propagate the service message over the network so that the network controller finds the node. There is Service pin as a mechanical switch on the LONWORKS option unit (refer to an attached instruction manual in detail).

Only LIU006Z has the software service pin function that operates the procedure shown in below.

1. Set the inverter parameter *F830* to 1.
2. Set the inverter parameter *F830* to 0.

Just after the parameter is set to "0", LONWORKS option unit propagates the message over the network.

3.3. Device interface (XIF) file

Device interface (XIF) files are the files that define the network-visible interface for one or more LONWORKS devices. The device interface is the interface to a device that is exposed over a LONWORKS network. The device interface includes the device's self-documentation information, the number of address table entries, the number of message tags, and the number, types, and directions of network variables.

XIF files are distributed on the web site "www.inverter.co.jp".

3.4. LNS Plug-in

LNS Plug-in provides one or more means to monitor or alter configuration properties or network variables. It may be used for device-specific configuration or monitoring. LIS006Z and LIS007Z are prepared as their device plug-ins for LIU006Z and LIU007Z.

The device plug-ins are also distributed on the web site "www.inverter.co.jp".

3.5. Inverter configurations

Set the inverter parameters according to the instruction manual attached with the product.

However, LONWORKS option unit will edit some of the inverter parameters (*FH, UL, LL, ACC, DEC, LL*) so that they should not be edited.

Configuration by PC commissioning software (PCM001Z) is also available by using serial communication option (USB001Z) through RS485 port.

N.B.: Refer to Section 2.3 for RS485 port specification in detail.

3.6. Command & Setpoint selection (Local/Remote)

Indication to display Local/Remote mode is on the inverter unit (Refer to the inverter instruction manual for details). LONWORKS option command and setpoint are activated on Remote mode^{*1}. LONWORKS option unit propagates the Local / Remote status to the network as the “Command from the network (bit5)” and “Setpoint from the network (bit6)” in “nvoStatusWord” network variable. Inverters have some switches to select the command and setpoint location. Following figure shows the diagram. Refer to the inverter instruction manual for the parameter in detail.

*1: Be careful that *CNOd* command and *FNOd* setpoint are activated for a short time just after the inverter power turned on. Set *CNOd* and *FNOd* to “Serial communication” (“network” for LIU006Z) to prevent this problem.

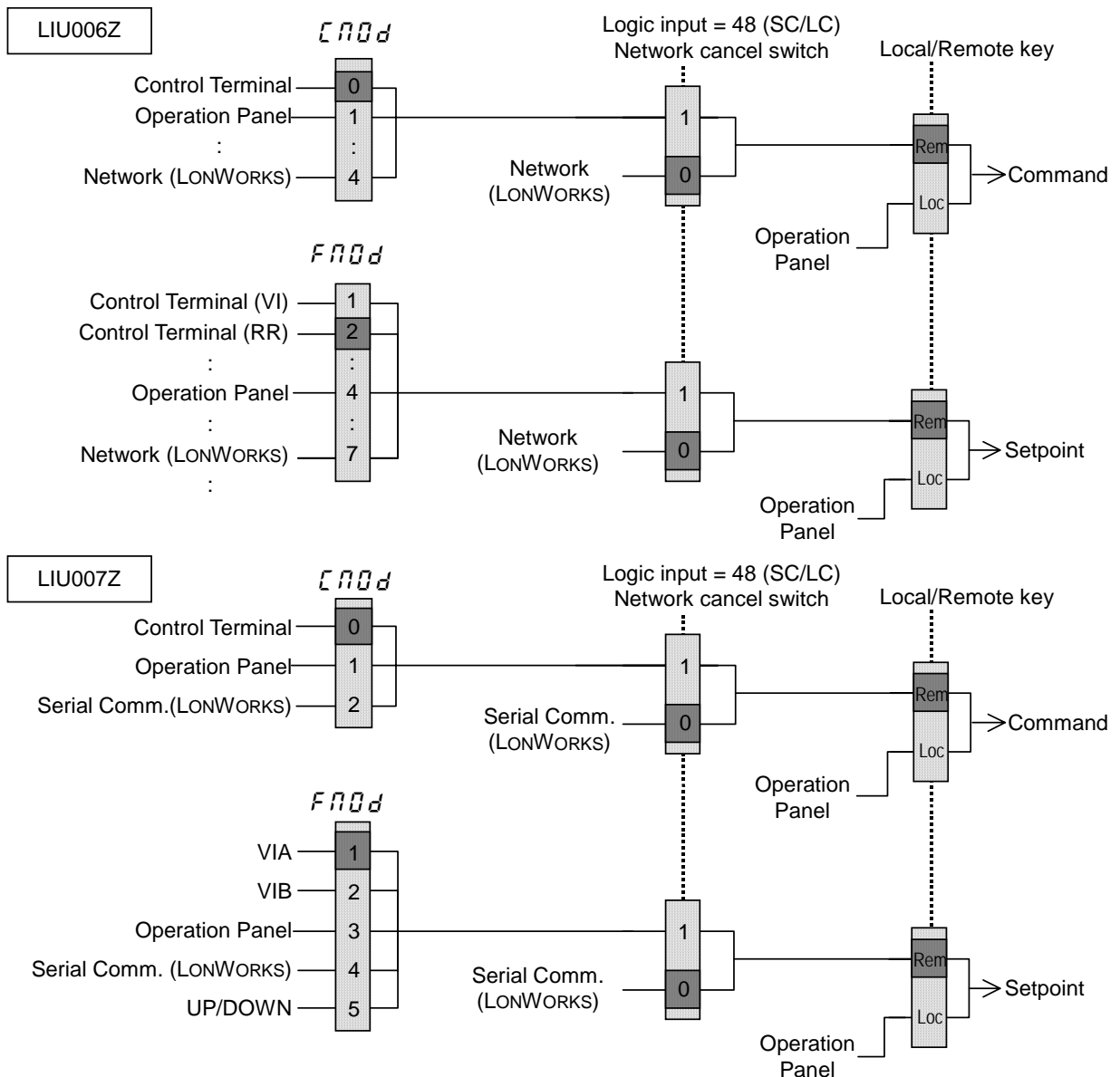

3.7. Reference parameter of the inverter

Reference parameter of the inverter is listed below.

Title	Name	Description
<i>ACC</i>	Acceleration time	Do not change these parameters, because the LONWORKS option unit using them.
<i>DEC</i>	Deceleration time	
<i>FH</i>	Maximum frequency	
<i>UL</i>	Upper limit frequency	
<i>LL</i>	Lower limit frequency	
<i>uL</i>	Base frequency 1	
<i>CNOd</i>	Command mode selection	Network command has priority when the inverter is Remote mode. (See previous section)
<i>FNOd</i>	Setpoint mode selection	Network setpoint has priority when the inverter is Remote mode. (See previous section)
<i>F111 ...</i>	Logic input terminal function	Set proper value if use (See the inverter instruction manual).
<i>F603</i>	Emergency stop selection	For "nviEmergOverride"
<i>F800</i>	Communication baud rate	Set "1" (default) for LIU007Z
<i>F801</i>	Communication parity	Set "1" (default) for LIU007Z
<i>F803</i>	Communication error trip time	Set properly value for LIU007Z
<i>F829</i>	Communication protocol	Set "1" (MODBUS) for LIU007Z
<i>F830</i>	Option parameter 1	Service pin function for LIU006Z
<i>F851</i>	Operation at network disconnection	See section "7.4 Communication health management".
<i>F899</i>	Option reset	Option reset function for LIU006Z. Set "1" to activate reset.

⚠ Warning



Mandatory

▼ For LIU007Z, set up "Communication error trip function (*F803*, see the inverter instruction manual for details)" to stop the inverter when this option unit is deactivated by an unusual event such as tripping, an operating error, power outage, failure, etc. Deactivated option unit may cause an accident, if the "Communication error trip function" is not properly set up.

4. Functional profile

4.1. Functional profile supported by this option

This LONWORKS option unit supports LONMARK Variable Speed Motor Drive functional profile (SFPTvariableSpeedMotorDrive, 6010_11). It has 2 objects (functional blocks) shown in the figure below.

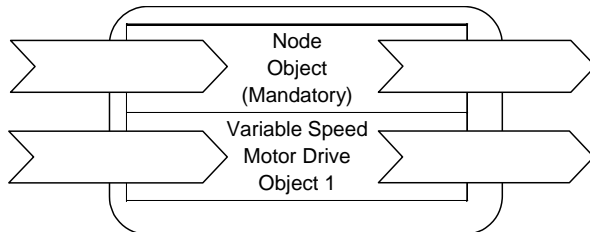

We implement the manufacturer specific variables into Variable Speed Motor Drive functional block, its external name is "ACMotorDrive". Node Object functional block's external name is "NodeObject".

4.2. Object id

Each object has individual object ID.

Object id	Object name	Description
0	NodeObject	LONMARK functional profile: Node Object
1	ACMotorDrive	LONMARK functional profile: Variable Speed Motor Drive

5. Node Object functional block

The Node Object functional block includes 2 mandatory network variables “nviRequest (Object request)” and “nvoStatus (object status)”. Upon receiving an update to the “nviRequest” network variable, the request is processed and the “nvoStatus” network variable is updated with either the results of the request, an in-process indication, or an error indication. The definition of the “nviRequest” network variable includes an object ID field to allow the Node Object to report status and alarm conditions for a device.

5.1. Object map

This figure shows the NodeObject object map.

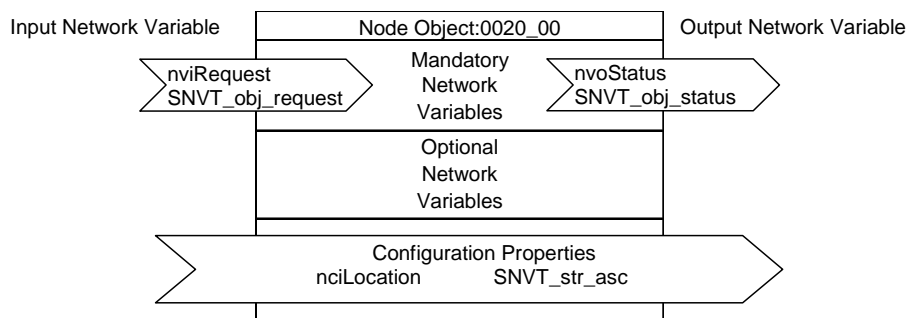

5.2. Network variables (Node Object)

Network variables included in Node Object functional block are shown in the table below.

LIU 007Z	LIU 006Z	Name	SNVT type	Function	LONMARK
v	v	nviRequest	SNVT_obj_request	Object request	Mandatory
v	v	nvoStatus	SNVT_obj_status	Object Status	Mandatory
---	---	nviTimeSet	SNVT_time_stamp	Time Setting	Optional
---	---	nviFileReq	SNVT_file_req	File Request	Optional
---	---	nvoFileStat	SNVT_file_status	File Status	Optional
---	---	nviFilePos	SNVT_file_pos	File Position	Optional
---	---	nvoFileDirectory	SNVT_address	File Directory Address	Optional
---	---	nvoAlarm2	SNVT_alarm_2	Alarm output	Optional
---	---	nviDateEvent	SNVT_date_event	Date Event	Optional
---	---	nvoDateResync	SNVT_switch	Date Resynchronization Request	Optional
---	---	nciNetConfig	SNVT_config_src	Network Configuration Source	Optional
---	---	nciMaxStsSendT	SNVT_elapsed_tm	Maximum Send Time	Optional
v	v	nciLocation	SNVT_str_asc	Location label	Optional
---	---	nciDevMajVer	unsigned short	Device Major Version	Optional
---	---	nciDevMinVer	unsigned short	Device Minor Version	Optional

v: Support, ---:Not support.

5.2.1. nciLocation (Location Label)

Configuration property, Node Object 0000_20 (Optional)

SNVT type: SNVT_str_asc (36)

SCPT reference: SCPT_location (17)

It can be used to provide physical location information.

- Valid Range:

Any NULL (“\0”) terminated ASCII string of 31 bytes total length. In fact 30 bytes are available because Null terminator has to be set the last byte.

- Default Value:

The default value is an ASCII string containing all Null (“\0”).

5.2.2. nviRequest (Object Request)

Input network variable, Node Object 0000_20 (Mandatory)

SNVT type: SNVT_obj_request (92)

This is the variable to request the node status response. LONWORKS option unit supports some requests shown in the table below.

Value	Request	Description
0	RQ_NORMAL	If the device was in the disabled state, this request cancels that state, and returns the functional block to normal operation.
1	RQ_DISABLED	It requests the specified functional block to change to the disabled state. This request always brings the motor to a controlled stop.
2	RQ_UPDATE_STATUS	It requests the status of the functional block to be sent to the “nvoStatus” output network variable. The state of the functional block is unchanged.
5	RQ_REPORT_MASK	It requests a status mask reporting the status bits that are supported by the functional block to be sent to the “nvoStatus” output network variable. A one bit in the status mask means that the device may set the corresponding bit in the object status when the condition defined for that bit occurs.
7	RQ_ENABLE	This request enables the system, without starting any action in the system (no spinning of motor, etc.)
9	RQ_CLEAR_STATUS	It requests all status and report bits for the functional block and in the “nvoStatus” output network variable to be cleared. The state of the functional block is unchanged.
10	RQ_CLEAR_ALARM	It requests the alarm state of the functional block to be cleared. If any alarm conditions are still present for the functional block, the alarms are reported again as they are detected.

N.B.: In case that receiving the invalid request, optional unit sets “1” to “invalid_request” bit of “nvoStatus” output network variable.

5.2.3. nvoStatus (Object Status)

Output network variable, Node Object 0000_20 (Mandatory)

SNVT type: SNVT_obj_status (93)

This is the variable to inform the object status. LONWORKS option unit supports some status shown in the table below.

Bit	Request	Description
---	object_id	object_id of requested functional block
0	invalid_id	Set to "1" if a request is received for a functional block index that is not defined in the device. No further checking of the request code is required when set to one.
1	invalid_request	Set to "1" if an unsupported request code (RQ_xxx) is received on the "nviRequest" input network variable.
2	disabled	Under the disabled state, <ul style="list-style-type: none"> - Output network variables belonging to the functional block are not propagated to the network. However, it must be possible to poll the output network variables of a functional block in this state. - The functional block must not respond to any updates received on its input network variables, but it must support reading and writing of any configuration properties belonging to the functional block. - If the functional block was already in the disabled state, a request to disable the functional block is not an error. - If the Node Object functional block is disabled, any other requests for the Node Object functional block are not disabled. - Status and alarm reporting via the "nvoStatus" outputs is not disabled when the Node Object functional block is disabled.
12	comm_failure (Only for LIU006Z)	Set to "1" when the communication fault between the inverter and the option unit
17	in_alarm	Set to "1" if the inverter fault occurred or Communication fault between the LONWORKS option unit and the inverter occurred.
19	report_mask	Set to "1" if an RQ_REPORT_MASK request is received by the "nviRequest" input network variable.

6. ACMotorDrive functional block

ACMotorDrive functional block includes the “Variable Speed Motor Drive (6010_11)”. It can perform Run/stop control of the inverter, intensive surveillance control of an operation state, monitor the inverter status through network variables.

6.1. Object map

The object map is the following.

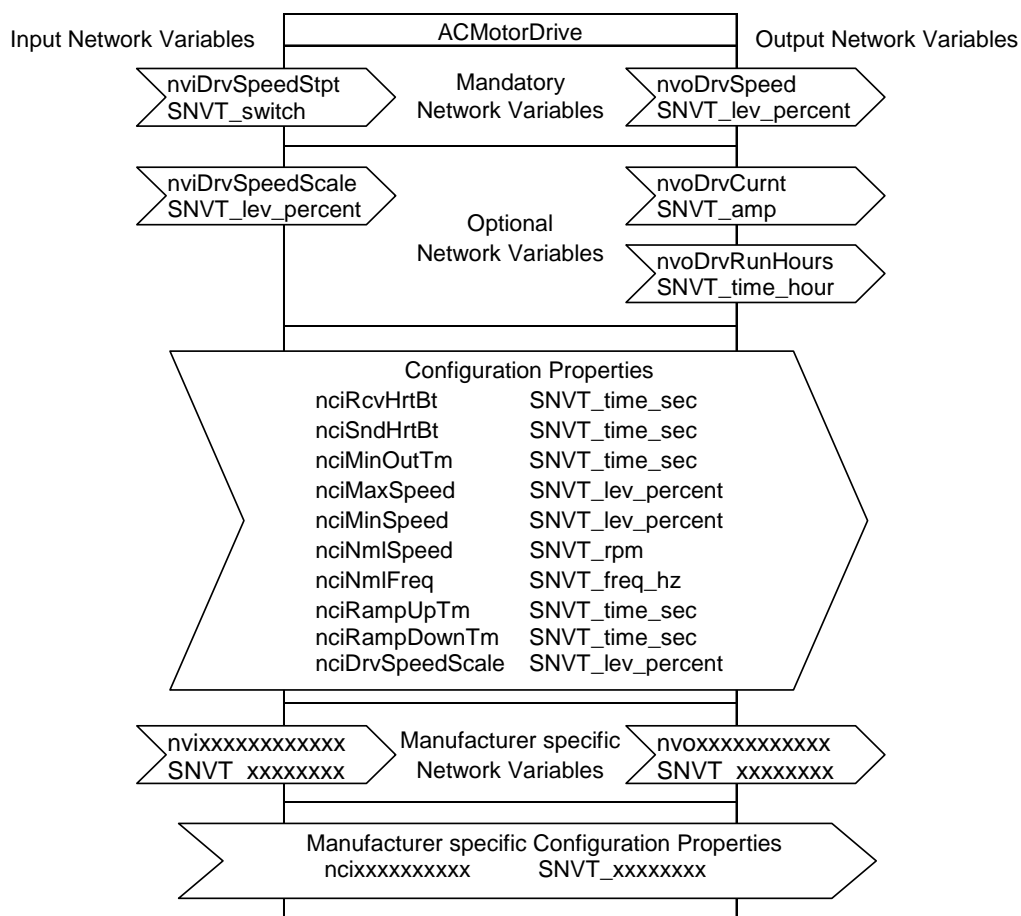

6.2. Network variable list (VSD_6010_11)

LONWORKS option unit supports all mandatory network variables included in LONMARK functional profile “Variable Speed Motor Drive”. The network variables are shown in the table below.

“nvi” means an input network variables, “nvo” means an output network variables and “nci” means a network configuration properties.

LIU 007Z	LIU 006Z	Variables	SNVT_type.	unit	Default value	LONMARK
v	v	nviDrvSpeedStpt	SNVT_switch	0.5%,1	{0.0%, -1}	Mandatory
v	v	nvoDrvSpeed	SNVT_lev_percent	0.005%		Mandatory
v	v	nviDrvSpeedScale	SNVT_lev_percent	0.005%	nciDrvSpeedScale	Optional
v	v	nvoDrvCurnt	SNVT_amp	0.1A		Optional
---	---	nvoDrvVolt	SNVT_volt	0.1V		Optional
---	---	nvoDrvPwr	SNVT_power_kilo	0.1kW		Optional
v	v	nvoDrvRunHours	SNVT_time_hour	1h		Optional
---	---	nciLocation	SNVT_str_asc	Ascii		Optional
v	v	nciMaxSpeed	SNVT_lev_percent	0.005%	100.000%	Mandatory
v	v	nciMinSpeed	SNVT_lev_percent	0.005%	0.000%	Mandatory
v	v	nciRcvHrtBt	SNVT_time_sec	0.1s	0.0s	Optional
v	v	nciSndHrtBt	SNVT_time_sec	0.1s	0.0s	Mandatory
v	v	nciMinOutTm	SNVT_time_sec	0.1s	0.5s	Optional
v	v	nciNmlSpeed	SNVT_rpm	1min ⁻¹	1800min ⁻¹	Mandatory
v	v	nciNmlFreq	SNVT_freq_hz	0.1Hz	60Hz	Mandatory
v	v	nciRampUpTm	SNVT_time_sec	0.1s	10.0s	Mandatory
v	v	nciRampDownTm	SNVT_time_sec	0.1s	10.0s	Mandatory
v	v	nciDrvSpeedScale	SNVT_lev_percent	0.005%	100.000%	Optional

v: Support, ---: Not support.

6.3. Network variable list (the other)

The other network variables are shown in the table below.

LIU006Z as an upper range, provides additional LONWORKS feature not supported by LIU007Z.

LIU 007Z	LIU 006Z	Variables	SNVT_type.	unit	Default value
v	v	nviResetFault	SNVT_switch	0.5%,1	{0.0%, 0}
v	v	nviInvSetFreq	SNVT_freq_hz	0.1Hz	3276.7Hz = invalid
v	v	nvoStatusWord	SNVT_state	boolean	
v	v	nvoDrvFeedback	SNVT_switch	0.5%,1	
v	v	nvoInvOutFreq	SNVT_freq_hz	0.1Hz	
v	v	nvoDrvAlarm	SNVT_switch	0.5%,1	
v	v	nvoAlarmWord	SNVT_state	boolean	
---	v	nvoDrvThermal	SNVT_lev_percent	0.005%	
---	v	nvoMotorThermal	SNVT_lev_percent	0.005%	
v	v	nvoTorque	SNVT_lev_percent	0.005%	
v	v	nvoDrvEnergy	SNVT_elec_kwh_l	0.1kWh	
v	v	nvoDigitalIn1	SNVT_switch	0.5%,1	
v	v	nvoDigitalIn2	SNVT_switch	0.5%,1	
---	v	nvoDigitalIn3	SNVT_switch	0.5%,1	
---	v	nvoDigitalIn4	SNVT_switch	0.5%,1	
---	v	nvoDigitalIn5	SNVT_switch	0.5%,1	
---	v	nvoDigitalIn6	SNVT_switch	0.5%,1	
---	v	nvoDigitalIn7	SNVT_switch	0.5%,1	
---	v	nvoDigitalIn8	SNVT_switch	0.5%,1	
---	v	nvoDigitalInput	SNVT_state	boolean	
---	v	nvoAnalogIn1	SNVT_lev_percent	0.005%	
v	v	nvoAnalogIn2	SNVT_lev_percent	0.005%	
---	v	nvoAnalogIn3	SNVT_lev_percent	0.005%	
v	v	nviRelay1	SNVT_switch	0.5%,1	{0.0%, 0}
---	v	nviDigitalOut1	SNVT_switch	0.5%,1	{0.0%, 0}
---	v	nviDigitalOut2	SNVT_switch	0.5%,1	{0.0%, 0}
---	v	nviDigitalOutput	SNVT_state	boolean	{0,0,...,0}
---	v	nviAnalogOut1	SNVT_lev_percent	0.005%	0.000%
---	v	nviAnalogOut2	SNVT_lev_percent	0.005%	0.000%
v	v	nviEmergOverride	SNVT_hvac_emerg	binary	
v	v	nvoEmergStatus	SNVT_hvac_emerg	binary	
v	v	nviParamCmd	SNVT_preset	binary	
v	v	nvoParamResp	SNVT_preset	binary	
v	v	nvoTypeVer	SNVT_str_asc	Ascii	
v	v	nciPwUpOutTm	SNVT_time_sec	0.1s	0.0s

v: Support, ---:Not support,

6.4. Configuration properties

6.4.1. nciMaxSpeed (Maximum Speed)

Configuration property (nc50), Variable Speed Drive 6010_11 (Mandatory)



SNVT type: SNVT_lev_percent (81)

SCPT reference: SCPTmaxSetpoint (50)

It is used to define the maximum speed of the inverter output. The value is entered as a percentage of nominal speed. The value of the maximum speed must be validated against the value of the minimum speed as follows:

- Valid range: $0.000\% \leq \text{minimum speed} \leq \text{maximum speed} \leq 163.830\%$
(Limited within the value of the inverter parameter “ $\underline{U}\underline{L}$ ” limitation)
- Unit: 0.005%
- Default Value: 100.000%

N.B.: By editing this variable, this option unit changes the inverter parameter “ $\underline{U}\underline{L}$ ”, automatically.
When setting small value, it may be limited by the lower limit of the inverter parameter “ $\underline{U}\underline{L}$ ”

 Danger	
 Prohibited	▼ Do not set the value out of valid range. Setting the value out of valid range may result in injuries by motor running with unexpected speed.

6.4.2. nciMinSpeed (Minimum Speed)

Configuration property, Variable Speed Drive 6010_11 (Mandatory)



SNVT type: SNVT_lev_percent (81)

SCPT reference: SCPTminSetpoint (53)

It is used to define the minimum speed of the inverter output. The value is entered as a percentage of nominal speed. The value of the minimum speed must be validated against the value of the maximum speed as follows:

- Valid range: $0.000\% \leq \text{minimum speed} \leq \text{maximum speed} \leq 163.830\%$
(Limited within the value of the inverter parameter “ $\underline{L}\underline{L}$ ” limitation)
- Unit: 0.005%
- Default Value: 0.000%

N.B.: By editing this variable, this option unit changes the inverter parameter “ $\underline{L}\underline{L}$ ”, automatically.

 Danger	
 Prohibited	▼ Do not set the value out of valid range. Setting the value out of valid range may result in injuries by motor running with unexpected speed.

6.4.3. nciRcvHrtBt (Receive Heartbeat Time)

Configuration property, Variable Speed Drive 6010_11 (Optional)



SNVT type: SNVT_time_sec (107)

SCPT reference: SCPTmaxRcvTime (48)

It is used to control the maximum period of time that elapses after the last update of the network variables ("nviDrvSpeedStpt", "nviDrvSpeedScale", "nviInvSetFreq") before detecting the network malfunction and initializing the command and setpoint values. Refer to "7.4:Communication health management" for the inverter behavior in that case.

- Valid range: 0.0 to 6553.4 sec
- Unit: 0.1s
- Default value: 0.0s

A value of 0.0 sec disables the Receive Heartbeat mechanism.

 Danger	
 Mandatory	<p>▼ Set up "nciRcvHrtBt" to stop the inverter when the option unit is disconnected from the network by network abnormality, etc. The option unit disconnected from the network may cause an accident, if the "nciRcvHrtBt" is not properly set up.</p>

6.4.4. nciSndHrtBt (Send Heartbeat Time)

Configuration property, Variable Speed Drive 6010_11 (Mandatory)

SNVT type: SNVT_time_sec (107)

SCPT reference: SCPTmaxSendTime (49)

It defines the maximum period of time that expires before the network variables specified for heartbeat in some monitor values will automatically be updated. This timer restarts to count just after sending network variables. Refer to "7.4:Communication health management" for details.

- Valid range: 0.0 to 6553.4 sec
- Unit: 0.1s
- Default value: 0.0s

A value of 0.0sec disables the automatic update.

6.4.5. nciMinOutTm (Minimum Send Time)

Configuration property, Variable Speed Drive 6010_11 (Optional)

SNVT type: SNVT_time_sec (107)

SCPT reference: SCPTminSendTime (52)

It defines the minimum period of time between automatic network variable transmissions. This function is prior to "nciSndHrtBt". This timer starts to count just after sending the last variable. Refer to "7.4:Communication health management" for details.

- Valid range: 0.0 to 6553.4 sec
- Unit: 0.1s
- Default value: 0.5s

Setting 0.0sec disables transmission limitation.

6.4.6. nciNmlSpeed (Nominal Motor Speed in min⁻¹)



Configuration property, Variable Speed Drive 6010_11 (Mandatory)

SNVT type: SNVT_rpm (102)

SCPT reference: SCPTnomRPM (158)

It is used to provide the nominal speed of the inverter output in min⁻¹.

- Valid range: 0 to 65534 min⁻¹
- Unit: 1 min⁻¹
- Default value: 1800 min⁻¹

 Danger	
 Prohibited	<ul style="list-style-type: none"> ▼ Do not change this value while the motor is running. Otherwise, It may result in injuries by motor running with unexpected speed. ▼ Do not set the value out of valid range. Otherwise, It may result in injuries by motor running with unexpected speed.

6.4.7. nciNmlFreq (Nominal Motor Frequency)

Configuration property, Variable Speed Drive 6010_11 (Mandatory)



SNVT type: SNVT_freq_hz (76)

SCPT reference: SCPTnomFreq (159)

This configuration property is used to provide the nominal speed of the inverter output in Hz. This is used as the base speed on ACMotorDrive functional block. It should be set to Rated Frequency of motor.

- Valid range: 25.0 to 500.0 Hz (for LIU006Z)
25.0 to 200.0 Hz (for LIU007Z)
- Unit: 0.1 Hz
- Default value: 60.0 Hz

N.B.: By editing this variable, this option unit changes the inverter parameter “ ω_L ” automatically.

 Danger	
 Prohibited	<ul style="list-style-type: none"> ▼ Do not change this value while the motor is running. Otherwise, It may result in injuries by motor running with unexpected speed. ▼ Do not set the value out of valid range. Otherwise, It may result in injuries by motor running with unexpected speed.

6.4.8. nciRampUpTm (Ramp Up Time)

Configuration property, Variable Speed Drive 6010_11 (Mandatory)

SNVT type: SNVT_time_sec (107)

SCPT reference: SCPTrampUpTm (160)

It determines the ramp up time of the motor.

- Valid range: 0.1 to 6000.0 sec. (LIU006Z)
0.1 to 3200.0 sec. (LIU007Z)
- Unit: 0.1 sec.
- Default value: 10.0 sec.

N.B.: By editing this variable, this option unit changes the inverter parameter “ R_L ” automatically.

6.4.9. nciRampDownTm (Ramp Down Time)

Configuration property, Variable Speed Drive 6010_11 (Mandatory)

SNVT type: SNVT_time_sec (107)

SCPT reference: SCPTrampDownTm (161)

It determines the ramp down time of the motor.

- Valid range: 0.1 to 6000.0 sec. (LIU006Z)
0.1 to 3200.0 sec. (LIU007Z)
- Unit: 0.1 sec.
- Default value: 10.0 sec.

N.B.: By editing this variable, this option unit changes the inverter parameter “ $dE\bar{L}$ ” automatically.

6.4.10. nciDrvSpeedScale (Default value for nviDrvSpeedScale)

Configuration property, Variable Speed Drive 6010_11 (Optional)

SNVT type: SNVT_lev_percent (81)

SCPT reference: SCPTdefScale (162)

It is used as the default value for “nviDrvSpeedScale”. When this option unit is initialized, it will be updated.

- Valid range: -163.840 to 163.830%
- Unit: 0.005%
- Default value: 100.000%

6.4.11. nciPwUpOutTm (Power up delay time).

Configuration property

SNVT type: SNVT_time_sec (107)

SCPT reference: SCPTpwrUpDelay (72)

It defines the time until starting transmission after the device powered up. It is useful to improve network traffic at power-up.

- Valid range: 0.0 to 300.0 sec (If the value exceed 300.0, the value is limited to 300.0 sec)
- Unit: 0.1 sec.
- Default value: 0.0 sec.

6.5. Input network variables

6.5.1. nviDrvSpeedStpt (Drive Speed Setpoint)

Input network variable, Variable Speed Drive 6010_11 (Mandatory)

SNVT type: SNVT_switch (95)

It provides start/stop control and a low resolution speed setpoint as a percentage of nominal speed.

Output frequency = “nciNmIFreq” x “nviDrvSpeedStpt.value” x “nviDrvSpeedScale”

- Valid range

nviDrvSpeedStpt		Operation
value	state	
N/A	0	Stop
0.0 to 100.0%	1	Drive at the speed from 0.5% to 100%
100.5 to 127.5%	1	Drive at 100% speed
N/A	-1	AUTO (Invalid)

- Unit (nviDrvSpeedStpt.value): 0.5%

- Default value: 0.0% (value), AUTO (state = -1),

Default value will be adopted at power-up and in case of not receiving an update of “nviSpeedStpt”, “nviDrvSpeedScale” or “nviInvSetFreq” within the specified Receive Heartbeat time (nciRcvHrtBt). Speed reference set by “nviInvSetFreq” will override “nviDrvSpeedStpt” (refer to “nviInvSetFreq”).

N.B. The value exceeded to the inverter setpoint resolution will be rounded.

6.5.2. nviDrvSpeedScale (Drive Speed Setpoint Scaling)

Input network variable, Variable Speed Drive 6010_11 (Optional)

SNVT type: SNVT_lev_percent (81)

This input network variable provides scaling for “nviDrvSpeedStpt”. Negative values indicate a motor direction in reverse.

- Valid range: -163.840 to 163.830%

- Unit: 0.005%

- Default value: “nciDrvSpeedScale”

Default value will be adopted at power-up and in case of not receiving an update of “nviSpeedStpt”, “nviDrvSpeedScale” or “nviInvSetFreq” within the specified Receive Heartbeat time (nciRcvHrtBt).

N.B. The value exceeded to the inverter setpoint resolution will be rounded.

6.5.3. nviResetFault (Fault Reset Command)

Input network variable

SNVT type: SNVT_switch (95)

This command clears the inverter fault when the inverter is under a fault that can be cleared.

- Valid range

nviResetFault		Command
value	state	
N/A	0, -1	Invalid
0.0%	1	
0.5% to 127.5%	1	Clear a fault and reset the inverter.

6.5.4. nviInvSetFreq (Frequency Setpoint)

Input network variable

SNVT type: SNVT_freq_hz (76)

It provides speed setpoint in Hz. The rotation direction is provided by “nviDrvSpeedScale” (Negative value means in reverse).

- Valid range: 0.0 Hz to the maximum vale in the inverter.

(Refer to the inverter instruction manual for details.)

nviInvSetFreq	nviDrvSpeedStpt		Operation
	value	state	
N/A	N/A	0	Stop
3276.7 Hz	value	1	Drive at the speed provided by “nviDrvSpeedStpt”
0.0 to 3276.6 Hz	N/A	1	Drive at the speed provided by “nviInvSetFreq”

Setpoint by “nviInvSetFreq” is limited by value of “nciMaxSpeed” and “nciMinSpeed”.

- Unit: 0.1Hz
- Default value: 3276.7Hz (In this case, nviDrvSpeedStpt enables to provide the setpoint)

Default value will be adopted at power-up and in case of not receiving an update of “nviSpeedStpt”, “nviDrvSpeedScale” or “nviInvSetFreq” within the specified Receive Heartbeat time (nciRcvHrtBt).

6.5.5. nviRelay1 /nviDigitalOut1,2 (Control of Digital Output)

Input network variable

SNVT type: SNVT_switch (95)

They enable a command of the Relays and Logic outputs on the inverter if they are assigned.

- Valid range

nviRelay1, nviDigitalOut1,2		Command
value	state	
N/A	0	Output OFF
0.0%	1	
0.5 to 127.5%	1	Output ON
N/A	-1	Invalid

- Assignment

If these variables are used, the inverter parameters must be set as follows.

Variables	LIU007Z		LIU006Z	
	Terminal	Parameter	Terminal	Parameter
nviDigitalOut1	---	---	OUT1	F130 = 92
nviDigitalOut2	---	---	OUT2	F131 = 94
nviRelay1	FL	F132 = 38	FL	F132 = 96

If multiple digital output control signals are used at the same time, the output value is the OR of all digital output controls.

6.5.6. nviDigitalOutput (Control of All Digital Outputs)

Input network variable (Only for LIU006Z)

SNVT type: SNVT_state (83)

This variable enables the command of all the Relays and Logic outputs of the inverter if they are assigned.

- Valid range

Bit	LIU007Z		LIU006Z	
	Terminal	Parameter	Terminal	Parameter
0	---	---	OUT1	F130 = 92
1	---	---	OUT2	F131 = 94
2	---	---	FL	F132 = 96
3	---	---	OUT3 ^{*1}	F133 = 98
			OUT5 ^{*1}	F136 = 98
4	---	---	OUT4 ^{*1}	F134 = 100
			OUT6 ^{*1}	F137 = 100
5	---	---	R1 ^{*1}	F131 = 102
			R2 ^{*1}	F138 = 102
6-15	---	---	---	(reserved)

If multiple digital output control signals are used at the same time, the output value is the OR of all digital output controls.

*1: OUT3, OUT4, OUT5, OUT6, R1 and R2 are on the Expansion I/O card option (ETB003Z, ETB004Z).

6.5.7. nviAnalogOut1,2 (Control of Analog output)

Input network variable (Only for LIU006Z)

SNVT type: SNVT_lev_percent (81)

They enable the analog output control.

- Valid range: 0.000 to 100.000%

(Output value is not adjusted by the inverter parameter "F \bar{n} ", "R \bar{n} ")

- Unit: 0.005% (The resolution depends on the inverter specification)

When the variables will be used, the inverter parameters must be assigned.

Name	LIU007Z		LIU006Z	
	Terminal	Parameter	Terminal	Parameter
nviAnalogOut1	---	---	FM	FMSL = 31
nviAnalogOut2	---	---	AM	AMSL = 31

6.5.8. nviEmergOverride (Emergency stop)

Input network variable

SNVT type: SNVT_have_emerg (103)

It provides an emergency stop of the motor. Emergency stop can be configured by Emergency stop selection (F503) to coast stop, slow down stop or emergency DC braking (refer to the inverter instruction manual for details).

- Valid range

Value	Command	Description
0	Remove emergency	EMERG_NORMAL (No Emergency mode)
1	Emergency stop	EMERG_PRESSURIZE (Emergency pressurize mode)
2		EMERG_DEPRESSURIZE (Emergency depressurize mode)
3		EMERG_PURGE (Emergency purge mode)
4		EMERG_SHUTDOWN (Emergency shutdown mode)
5		EMERG_FIRE (Emergency fire mode)
6 to 255		---

N.B.: "Remove emergency" command clears a fault and resets the inverter.

6.5.9. nviParamCmd (Parameter access)

Input network variable

SNVT type: SNVT_preset (94)

It is used to access the inverter parameters. Refer to section 7.5 "Parameter access method" for the example usage.

- Valid range: All accessible parameters in the inverter (except for E000 to E499)

- Format:

field	Length	Description
learn	1 byte	Command
		0 (LN_RECALL) : Not support
		1 (LN_LEARN_CURRENT) : Not support
		2 (LN_LEARN_VALUE) : Write
		3 (LN_REPORT_VALUE) : Read
selector	2 bytes	Parameter address (unsigned value) *1
value[0]	1 byte	0
value[1]	1 byte	0
value[2]	1 byte	The most significant 2 hex bytes of data
value[3]	1 byte	The least significant 2 hex bytes of data
day	2 bytes	Invalid *2
hour	1 byte	Invalid *2
minute	1 byte	Invalid *2
second	1 byte	Invalid *2
millisecond	2 bytes	Invalid *2

*1: This value is Hexadecimal value, but it may be displayed with decimal value on network tool.

*2: The time fields (day, hour, minute, second and millisecond) are not supported by this option unit. Any values in the time fields of the Parameter access command will be ignored.

6.6. Output network variables

6.6.1. Output network variable update

Normally, output network variables are updated when the inverter status was changed. Automatic transmission function is also prepared by “nciSndHrtBt (Send Heartbeat Time)”, “nciMinOutTm (Minimum Send Time)” configuration properties.

See section 7.4 “Communication health management” for detail.

6.6.2. nvoDrvCurnt (Drive Output Current)

Output network variable, Variable Speed Drive 6010_11 (Optional)

SNVT type: SNVT_amp (1)

It provides the inverter output current in amperes.

- Valid range: 0.0 to 3276.6 A It is overwritten 0.0A when the inverter faulted.)
- Unit: 0.1 A

6.6.3. nvoDrvSpeed (Drive Speed Feedback)

Output network variable, Variable Speed Drive 6010_11 (Mandatory)

SNVT type: SNVT_lev_percent (81)

It provides the motor speed as a percentage of the nominal speed. Negative value means a speed in reverse.

- Valid range: -163.840 to 163.830%
- Unit: 0.005% (The resolution depends on the inverter specification)

N.B.: It indicates the rotating direction at the time of a stop, only when at the time of the operation starts after changing rotating direction. However, the rotating direction of the inverter performs correctly.

6.6.4. nvoDrvRunHours (Drive Total Running Hours)

Output network variable, Variable Speed Drive 6010_11 (Optional)

SNVT_type: SNVT_time_hour (124)

This output network variable provides the total operation time for the motor in running hours.

- Valid range: 0 to 65534 h (The overflow caused the value to return 0.)
- Unit: 1 h

6.6.5. nvoInvOutFreq (Frequency Feedback)

Output network variable

SNVT type: SNVT_freq_hz (76)

It provides the inverter output frequency.

- Valid range: 0.0Hz to 3276.6Hz
- Unit: 0.1Hz

6.6.6. nvoDrvFeedback (Velocity Feedback)

Output network variable

SNVT type: SNVT_switch (95)

It provides stopped / running status and low resolution output speed of the motor.

- Specification

nvoDrvFeedback		Operation
value	state	
N/A	0	Stop
0.0 to 127.5%	1	Drive at 0.0 to 127.5% speed. value = (Drive frequency) / nciNmIFreq / nviDrvSpeedScale

N.B.: When the speed exceeds the 127.5%, "value" is limited to 127.5%

If "nviDrvSpeedScale" was set to 0, nvoDrvFeedback.value shows 0.0%.

The value exceeded to the resolution will be rounded.

6.6.7. nvoStatusWord (Inverter Status)

Output network variable

SNVT type: SNVT_state (83)

It provides the inverter status.

- Format:

Bit	Description	0	1
0	Fault	No fault	Fault
1	Warning	No warning	Warning
2	Running	Stopped	Running
3	Rotation	Forward	Reverse
4	Ready	Disable	Enable
5	Command from the network	Not from the network	From the network
6	Setpoint from the network	Not from the network	From the network
7	At setpoint	Setpoint not reached	Setpoint reached
8-15	(reserved)	-----	-----

N.B.: On LIU007Z, "At setpoint" bit could work under the condition that VF-FS1 software version was V106 or successor,

6.6.8. nvoDrvAlarm (Alarm)

Output network variable

SNVT type: SNVT_switch (95)

It provides the inverter fault.

- Status

nvoDrvAlarm		Status
value	state	
0%	0	No fault
100%	1	Fault

*Refer to "nvoAlarmWord" for detail fault information.

6.6.9. nvoAlarmWord (Alarm Status)

Output network variable

SNVT type: SNVT_state (83)

It provides the inverter fault status. If the inverter faulted, "Fault" bit and the contents bit are set to ON.

Bit	Description
0	Fault
1	Supply fault
2	Inverter fault
3	Motor fault (overvoltage, phase loss, overheating ...)
4	Process fault
5	External fault (including I/O fault)
6	Communication fault
7-15	(reserved)

6.6.10. nvoDrvThermal (Drive Thermal State)

Output network variable (Only for LIU006Z)

SNVT type: SNVT_lev_percent (81)

It provides the inverter thermal level in percentage. 100% means Over Heat fault.

- Valid range: 0.000% to 163.830%
- Unit: 0.005% (The resolution depends on the inverter specification)

6.6.11. nvoMotorThermal (Motor Thermal State)

Output network variable (Only for LIU006Z)

SNVT type: SNVT_lev_percent (81)

It provides motor thermal level in percentage. This value is shown in percentage based on motor thermal fault level.

- Valid range: 0.000% to 163.830%
- Unit: 0.005% (The resolution depends on the inverter specification)

6.6.12. nvoTorque (Motor Torque Monitor)

Output network variable,

SNVT type: SNVT_lev_percent (81)

It provides the motor torque in percentage of nominal motor torque calculated by the inverter.

- Valid range: -163.840% to 163.830% (LIU006Z)
0.000% to 163.830% (LIU007Z)
(If an overflow occurred, the value is limited to maximum value.)
- Unit: 0.005% (The resolution depends on the inverter specification)

N.B.: It is overwritten 0.000% when the inverter faulted.

6.6.13. nvoDrvEnergy (Cumulative Input Energy)

Output network variable,

SNVT type: SNVT_elec_kwh_I (146)

It provides the cumulative input energy calculated by the inverter.

- Valid range: 0.0kWh to 42949672.9kWh (If an overflow occurred, the value returns to 0.)
- Unit: 0.1kWh

*How to clear the value

This cumulative data value is cleared if the inverter power source is cycled with setting the parameter *F748* to 0. When clearing it without cycling the power source, use inverter parameter *F820*. Refer to section 7.5 "Parameter access method" for detail.

6.6.14. nvoDigitalInput (All Digital Inputs Monitor)

Output network variable (Only for LIU006Z)

SNVT_type: SNVT_state (83)

It provides all states of the inverter logic input terminals. Each bit is set to "1" when the terminal is activated.

Bit field is arranged as the table shown in below.

Bit	LIU007Z	LIU006Z
0	-----	F terminal
1	-----	R terminal
2	-----	(reserved)
3	-----	RES terminal
4	-----	S1 terminal
5	-----	S2 terminal
6	-----	S3 terminal
7	-----	RR/S4 terminal
8	-----	LI1 terminal*
9	-----	LI2 terminal*
10	-----	LI3 terminal*
11	-----	LI4 terminal*
12	-----	LI5 terminal*
13	-----	LI6 terminal*
14	-----	LI7 terminal*
15	-----	LI8 terminal*

*Terminals LI1 to LI8 are placed on the expansion terminal option cards (ETB003Z, ETB004Z)

6.6.15. nvoDigitalIn1 to 8 (Digital Input Monitor)

Output network variable

SNVT type: SNVT_switch (95)

They provide the inverter logic input terminal state.

- Status

nvoDigitalIn1 to 8		Status
value	state	
0%	0	Input OFF
100%	1	Input ON

The relationship between the network variables and input terminals is shown in below.

Variables	LIU007Z	LIU006Z
nvoDigitalIn1	F terminal	F terminal
nvoDigitalIn2	R terminal	R terminal
nvoDigitalIn3	-----	(reserved)
nvoDigitalIn4	-----	RES terminal
nvoDigitalIn5	-----	S1 terminal
nvoDigitalIn6	-----	S2 terminal
nvoDigitalIn7	-----	S3 terminal
nvoDigitalIn8	-----	RR/S4 terminal

6.6.16. nvoAnalogIn1 to 3 (Analog Input Monitor)

Output network variable

SNVT type: SNVT_lev_percent (81)

They provide the inverter analog input terminal state in percentage.

- Valid range: 0.000 to 100.000%

(At only RX terminal, -100.000 to 100.000%)

- Unit: 0.005% (The resolution depends on the inverter specification)

The adjustment of analog input value is possible to set the inverter parameter (*F470* to *F475*)

(Refer to the inverter instruction manual for details).

The relationship between the network variable and the terminal is shown in the table below.

Name	LIU007Z	LIU006Z
nvoAnalogIn1	----	RR/S4 terminal
nvoAnalogIn2	VIB terminal	VI/II terminal
nvoAnalogIn3	----	RX terminal

When RR/S4 terminal has Logic input terminal function, “nvoAnalogIn1” always shows 0.000%.

6.6.17. nvoEmergStatus (Emergency Status)

Output network variable

SNVT type: SNVT_have_emerg (103)

It provides the response against an emergency stop of the inverter (nviEmergOverride). When the node received “nviEmergOverride” network variable, it propagates the information to the network.

- Valid range

Value	Status	Description
0	Trip release	EMERG_NORMAL (No Emergency mode)
1	Emergency stop	EMERG_PRESSURIZE (Emergency pressurize mode)
2		EMERG_DEPRESSURIZE (Emergency depressurize mode)
3		EMERG_PURGE (Emergency purge mode)
4		EMERG_SHUTDOWN (Emergency shutdown mode)
5		EMERG_FIRE (Emergency fire mode)
6 to 255		---

6.6.18. nvoParamResp (Parameter Access Response)

Output network variable

SNVT type: SNVT_preset (94)

It provides to the response of the inverter parameters accessing (nviParamCmd). Refer to “7.5 Parameter access method” for the example usage.

- Format

field	Length	Description
learn	1 byte	Command 2 (LN_LEARN_VALUE) : Write 3 (LN_REPORT_VALUE) : Read the other : Not support
selector	2 bytes	Parameter address (unsigned value) ^{*1}
value[0]	1 byte	0 at successful, FFh at occurred error ^{*2}
value[1]	1 byte	0
value[2]	1 byte	The most significant 2 hex bytes of data
value[3]	1 byte	The least significant 2 hex bytes of data
day	2 bytes	0
hour	1 byte	0
minute	1 byte	0
second	1 byte	0
millisecond	2 bytes	0

*1: This value may be displayed with decimal value on network tool.

*2: When access error occurred, “value[0]” field shows FFh and the error code is shown in “value[3]” field.

01h: Illegal function for the addressed node

02h: Illegal parameter address

03h: Illegal data value

04h: Illegal access (cf. prohibit writing)

6.6.19. nvoTypeVer (Identification)

Output network variable

SNVT type: SNVT_str_asc (36) polled

It provides the inverter identification data (Brand, Commercial Reference, Version) by Ascii code. The string is ended by Null terminator (“\0”). This variable can be read only with polling.

- Structure

Data	Length	Description	ASCII
Vendor name	7	“TOSHIBA”	-----
space	1	Character “space”	0x20
Product code	free	“VFPS1-xxxx...”, “VF-FS1-xxxx...”	-----
space	1	Character “space”	0x20
V	1	Character “V”	0x56
major revision	1	Software version (major)	-----
.	1	Character “.”	0x2E
minor revision	2	Software version (minor)	-----

Ex. “TOSHIBA VFFS1-2022PM V1.06”

7. Example usage

7.1. Procedure

Lower example shows the procedure to send the 100% speed drive command to the inverter.

1. Commission

Make a network tool to identify this option by using service pin function (refer to network tool manual in detail).

2. Binding

Refer to next section.

3. Configurations

Set correct value into the configuration properties.

4. Local/Remote

Confirm that the inverter is in Remote control mode. Otherwise set Remote control mode.

5. Drive command and setpoint

Set the {200, 1} (100% speed drive) into the nviDrvSpeedStpt and propagate it.

7.2. Binding

Network variable bound to the other network variable can transmit/receive the data. "Binding" can be made by network tool. Network variable has a direction (Input/Output) and individual type (SNVT_type). Binding to the same direction variable or the different type is prohibited.

■ Example connection

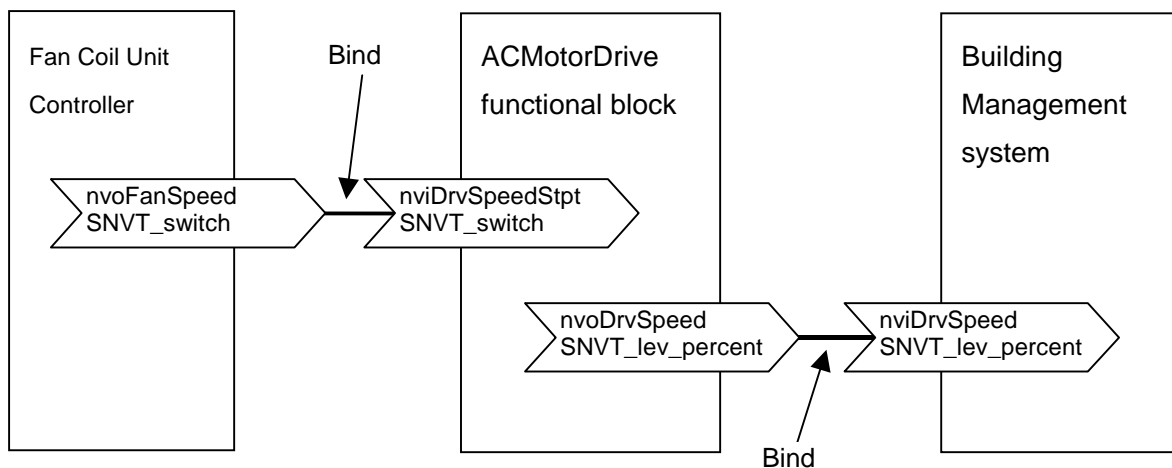

7.3. Option unit reset method

One method to reset the option unit is cycling the inverter power source.

For VF-FS1, the other is using reset command by network tool.

VF-PS1 has option reset command by the parameter *F 8 8 8*. (Refer to VF-PS1 instruction manual)

7.4. Communication health management

This option unit has communication health management function.

1. Communication time out function (nciRcvHrtBt)

This value manages the communication time out function. This option unit would initialize the drive command/setpoint variables and try to stop the motor in case of not receiving an update of the following variables within the specified Receive Heartbeat time (nciRcvHrtBt).

- nviDrvSpeedStpt
- nviDrvSpeedScale
- nviInvOutFreq

In this case, the inverter output behavior can be determined by the parameter *F851*. However, next selections are invalid.

- None (continued operation)
- Preset speed operation (only for VF-PS1)

2. Node health transmission function (nciSndHrtBt, nciMinOutTm)

This option unit informs the network manager to its own health. Network variables controlled by this function are shown in the table below.

Variables	LIU007Z		LIU006Z	
	nciSndHrtBt	nciMinOutTm	nciSndHrtBt	nciMinOutTm
nvoDrvSpeed	v	v	v	v
nvoDrvCurnt	v	v	v	v
nvoDrvVolt	v	v	v	v
nvoDrvPwr	v	v	v	v
nvoDrvRunHours	v	v	v	v
nvoStatusWord	v	v	v	v
nvoDrvFeedback	v	v	v	v
nvoInvOutFreq	v	v	v	v
nvoDrvAlarm	v	v	v	v
nvoAlarmWord	v	v	v	v
nvoDrvThermal	/	/	v	v
nvoMotorThermal	/	/	v	v
nvoTorque	v	v	v	v
nvoDrvEnergy	v	v	v	v
nvoDigitalIn1	v	v	v	v
nvoDigitalIn2	v	v	v	v
nvoDigitalIn3	/	/	v	v
nvoDigitalIn4	/	/	v	v
nvoDigitalIn5	/	/	v	v
nvoDigitalIn6	/	/	v	v
nvoDigitalIn7	/	/	v	v
nvoDigitalIn8	/	/	v	v
nvoDigitalInput	/	/	v	v
nvoAnalogIn1	/	/	v	v
nvoAnalogIn2	v	v	v	v
nvoAnalogIn3	/	/	v	v
nvoEmergStatus	---	---	---	---
nvoParamResp	---	---	---	---
nvoTypeVer	---	---	---	---

v: controlled by nciSndHrtBt and nciMinOutTm

7.5. Parameter access method

Parameter access is allowed by using nviParamCmd and nvoParamResp network variables. The structure format is shown in below table.

Field	Length	Description
learn	1 byte	Command 2 (LN_LEARN_VALUE) : Write 3 (LN_REPORT_VALUE) : Read
selector	2 bytes	Parameter address (unsigned value)
value[0]	1 byte	0 at successful 0xFF at occurred error
value[1]	1 byte	0
value[2]	1 byte	The most significant 2 hex bytes of data
value[3]	1 byte	The least significant 2 hex bytes of data
day ,hour, minute, second, millisecond	Total 7 bytes	N/A

- Example 1: Read access

A controller node reads the value of Trip code (address FC90). Now, **OL** trip (trip code is 13 decimal) occurs. The value is 000D hex. The controller node sends/receives the following data.

Field	Send (nviParamCmd)	Receive (nviParamResp)
learn	LN_REPORT_VALUE	LN_REPORT_VALUE
selector	FC90 hex	FC90 hex
value[0]	N/A	0
value[1]	N/A	0
value[2]	N/A	00 hex
value[3]	N/A	0D hex
day ,hour, minute, second, millisecond	N/A	0

- Example 2: Write access

The controller node writes cumulative energy clear command (address FA20). The data value is 0002 hex. The controller node sends/receives the following data.

Field	Send (nviParamCmd)	Receive (nviParamResp)
learn	LN_LEARN_VALUE	LN_LEARN_VALUE
selector	FA20 hex	FA20 hex
value[0]	00 hex	00 hex
value[1]	00 hex	00 hex
value[2]	00 hex	00 hex
value[3]	02 hex	02 hex
day ,hour, minute, second, millisecond	N/A	0

N.B.: After sending cumulative energy clear command, 0000 hex should be re-written into FA20.

- Example 3: Illegal access

Illegal data is written to the inverter parameter $F171$, (Base frequency voltage, address 0171). The upper limit value is 330.0V (200V class). In case of writing 360.0V, the unit of this parameter is 0.1V and the data value is converted to hexadecimal, so the value is 0E10 hex. The controller node sends/receives the following data (out of range error).

Field	Send (nviParamCmd)	Receive (nviParamResp)
learn	LN_LEARN_VALUE	LN_LEARN_VALUE
selector	0171 hex	0171 hex
value[0]	00 hex	FF hex
value[1]	00 hex	00 hex
value[2]	0E hex	00 hex
value[3]	10 hex	03 hex
day ,hour, minute, second, millisecond	N/A	0

8. Specifications

Item	Specification	Notes
Number of domains	2	
Number of address entries	LIU006Z: 53 LIU007Z: 37	
Number of alias tables	8	
Communication transceiver	Free topology transceiver TP/FT-10 channel type.	ANSI/EIA/CEA 709.3
Baudrate	78kbps	
Protocol	LonTalk	ANSI/EIA 709.1
Communication signal	2 wires plus shield	NETA, Sheild, NETB
Transmission distance	Free topology: Between devices: 400m or less Total cable length: 500m or less Bus topology (both terminated): Total cable length: 1400m or less Stub length: 3m or less	When recommended cable is used: Level 4/22AWG
Functional block	Node Object (0) Variable Speed Motor Drive (1)	LONMARK functional profile Variable Speed Motor Drive (6010_11)
Number of Network variables	LIU006Z Input network variables: 13 Output network variables: 28 Configuration properties: 12 LIU007Z Input network variables: 8 Output network variables: 17 Configuration properties: 12	The LIU006Z, as an upper range, provides additional features not supported by LIU007Z.
Number of connected nodes	64 nodes at maximum	However, a host and routers are counted as one node.
Service pin function	LIU006Z Provided by setting the inverter parameter. LIU007Z Mechanical switch (SW2)	Used for notification of Neuron ID to the host.
Terminal block	Detachable terminal block 3-pole	Applicable terminal block Manufacturer: PHOENIX CONTACT Type-Form : MSTB 2,5/3-ST-5,08