

**TOSVERT VF-AS1/PS1 series**

---

**EtherNet/IP™ option unit Function Manual**

---

**IPE001Z**

---

**NOTICE**

1. Make sure that this instruction manual is delivered to the end user of EtherNet/IP™ option unit.
2. Read this manual before installing or operating the EtherNet/IP™ option unit. Keep it in a safe place for reference.
3. All information contained in this manual are subject to change without notice. Please confirm the latest information on our web site "[www.inverter.co.jp](http://www.inverter.co.jp)".

## Introduction



Thank you for purchasing the “EtherNet/IP™ option (IPE001Z)” for TOSVERT VF-AS1/PS1 inverter. Before using EtherNet/IP™ option, carefully read this function manual in order to completely and correctly utilize its excellent performance.

After reading this function manual, please keep it handy for future reference. For details of its general handling, see an instruction manual attached with the option unit.





- TOSVERT VF-AS1 Instruction Manual.....E6581301
- TOSVERT VF-PS1 Instruction Manual.....E6581386
- IPE001Z Instruction Manual .....E6581580

EtherNet/IP™ is a trademark of ControlNet International, Ltd.

### ■ Handling in general

 <b>Warning</b>	
 Prohibited	▼ Do not connect or disconnect a network cable while the Inverter power is on. It may lead to electric shocks or fire.
 Mandatory	▼ See the instruction manual attached with the option unit for cautions the handling. Otherwise, it may lead to electric shocks, fire, injuries or damage to product.

### ■ Network control

 <b>Warning</b>	
 Prohibited	▼ Do not send the value out of the valid range to network variables. Otherwise, the motor may suddenly start/stop and that may result in injuries.
 Mandatory	▼ Use an additional safety device with your system to prevent a serious accident due to the network malfunctions. Usage without an additional safety device may cause an accident.
 <b>Caution</b>	
 Mandatory	▼ Set up “Communication error trip function (see below)” to stop the Inverter when the option unit is deactivated by an unusual event such as tripping, an operating error, power outage, failure, etc. <ul style="list-style-type: none"> <li>- Network Time-Out, Inverter operation at disconnection, Preset speed operation selection</li> </ul> (Refer to “3.2.3 Network error detection (f849 - F8529.”) Deactivated the option unit may cause an accident, if the “Communication error trip function” is not properly set up. ▼ Make sure that the operation signals are STOP before resetting Inverter’s fault. The motor may suddenly start and that may result in injuries.

### ■ Notes on operation

<b>Notes</b>	
	▼ When the control power is shut off by the instantaneous power failure, communication will be unavailable for a while. ▼ The Life of EEPROM is approximately 100,000 times. Avoid writing a command more than 100,000 times to the same parameter of the Inverter and the communication board.

# Table of Contents

<b>1. OVERVIEW</b> .....	<b>4</b>
<b>2. NAMES AND FUNCTIONS</b> .....	<b>4</b>
2.1. Outline .....	4
2.2. RJ45 connector pin layout .....	5
2.3. Example of connection to an EtherNet/IP .....	5
2.4. LED indicator .....	6
<b>3. PARAMETERS</b> .....	<b>7</b>
3.1. Communication parameters .....	7
3.2. The details of the parameter setting .....	10
3.2.1. DEVICE NAME ( <i>F 792-F 799</i> ) .....	10
3.2.2. Assigning IP addresses ( <i>F 576 - F 588</i> ) .....	11
3.2.3. Network error detection ( <i>F 849 - F 852</i> ) .....	11
3.2.4. Command data ( <i>F 831-F 838</i> ), Monitor data ( <i>F 841-F 848</i> ) .....	13
3.2.4.1. How to use Instance 102/152 and 103/104 .....	13
3.2.4.2. FA06 (Command word 1) .....	14
3.2.4.3. FA23 (Command word 2) .....	15
3.2.4.4. FA07 (Frequency reference from comunciation option) .....	16
3.2.4.5. FA33 (Torque reference from communication option) .....	16
3.2.4.6. FA50 (Terminal output data from communication) .....	16
3.2.4.7. FA51 (Analog output (FM) data from communication) .....	16
3.2.4.8. FA52 (Analog output (AM) data from communication) .....	16
3.2.4.9. FD01 (Inverter status (real time)) .....	17
3.2.4.10. FD00 (Output frequency (real time)) .....	17
3.2.4.11. FD03 (Output current (real time)) .....	18
3.2.4.12. FE36 (Analog input value VI/II) .....	18
3.2.4.13. FE37 (RX Input) .....	18
3.2.4.14. FE60 - FE63 (My Monitor) .....	18
3.2.4.15. FE14 (Cumulative run time) .....	18
3.2.4.16. FE40 (Analog output (FM)) .....	18
3.2.4.17. FC91 (Alarm code) .....	19
3.2.4.18. FD06 (Input terminal board status) .....	19
3.2.4.19. FD07 (Output terminal board status) .....	19
<b>4. OBJECTS</b> .....	<b>20</b>
4.1. Identity Object (01 hex) .....	21
4.2. Message Router Object (02 hex) .....	23
4.3. Assembly Object (04 hex) .....	24
4.4. Connection Manager Object (06 hex) .....	25
4.5. Motor Data Object (28 hex) .....	26
4.6. Control Supervisor Object (29 hex) .....	27
4.6.1. Run/Stop Event Matrix .....	28
4.6.2. Control Supervisor State Transition Diagram .....	28
4.7. AC/DC Drive Object (2A hex) .....	29
4.8. Application Objects (64 hex) .....	30
4.9. Port Object (F4 hex) .....	31
4.10. TCP/IP interface (F5 hex) .....	33
4.11. Ethernet link (F6 hex) .....	34

<b>5. CONFIGURATION OF THE ASSEMBLIES .....</b>	<b>36</b>
5.1. List of Assembly Object Instance .....	36
5.1.1. Instance 20: CIP basic speed control output .....	37
5.1.2. Instance 70: CIP basic speed control input .....	37
5.1.3. Instance 21: CIP extended speed control output .....	38
5.1.4. Instance 71: CIP extended speed control input .....	38
5.1.5. Instance 22: CIP speed and torque control output .....	39
5.1.6. Instance 72: CIP speed and torque control input .....	39
5.1.7. Instance 23: CIP extended speed and torque control output .....	39
5.1.8. Instance 73: CIP extended speed and torque control input .....	39
5.1.9. Instance 100 : Native drive output .....	40
5.1.10. Instance 150 : Native drive input .....	40
5.1.11. Instance 101: Native drive output .....	42
5.1.12. Instance 151 : Native drive input .....	42
5.1.13. Instance 102: Native drive output .....	44
5.1.14. Instance 152: Native drive input .....	44
5.1.15. Instance 103: Allen Bradley Drive Profile Output .....	45
5.1.16. Instance 104: Allen Bradley Drive Profile Input .....	46
<b>6. ABOUT EDS-FILE .....</b>	<b>47</b>
<b>7. UNUSUAL DIAGNOSIS.....</b>	<b>48</b>
7.1. Option error .....	48
7.2. Disconnection error of network cable .....	48

# 1. Overview

The EtherNet/IP™ interface (IPE001Z) allows the VF-AS1/PS1 inverter to be connected into an EtherNet/IP™ network.

IPE001Z is applicable for VF-AS1 (software version V150 or later) and VF-PS1 (software version V650 or later).

## 2. Names and functions

The drawing below shows names and functions of main parts.

### 2.1. Outline

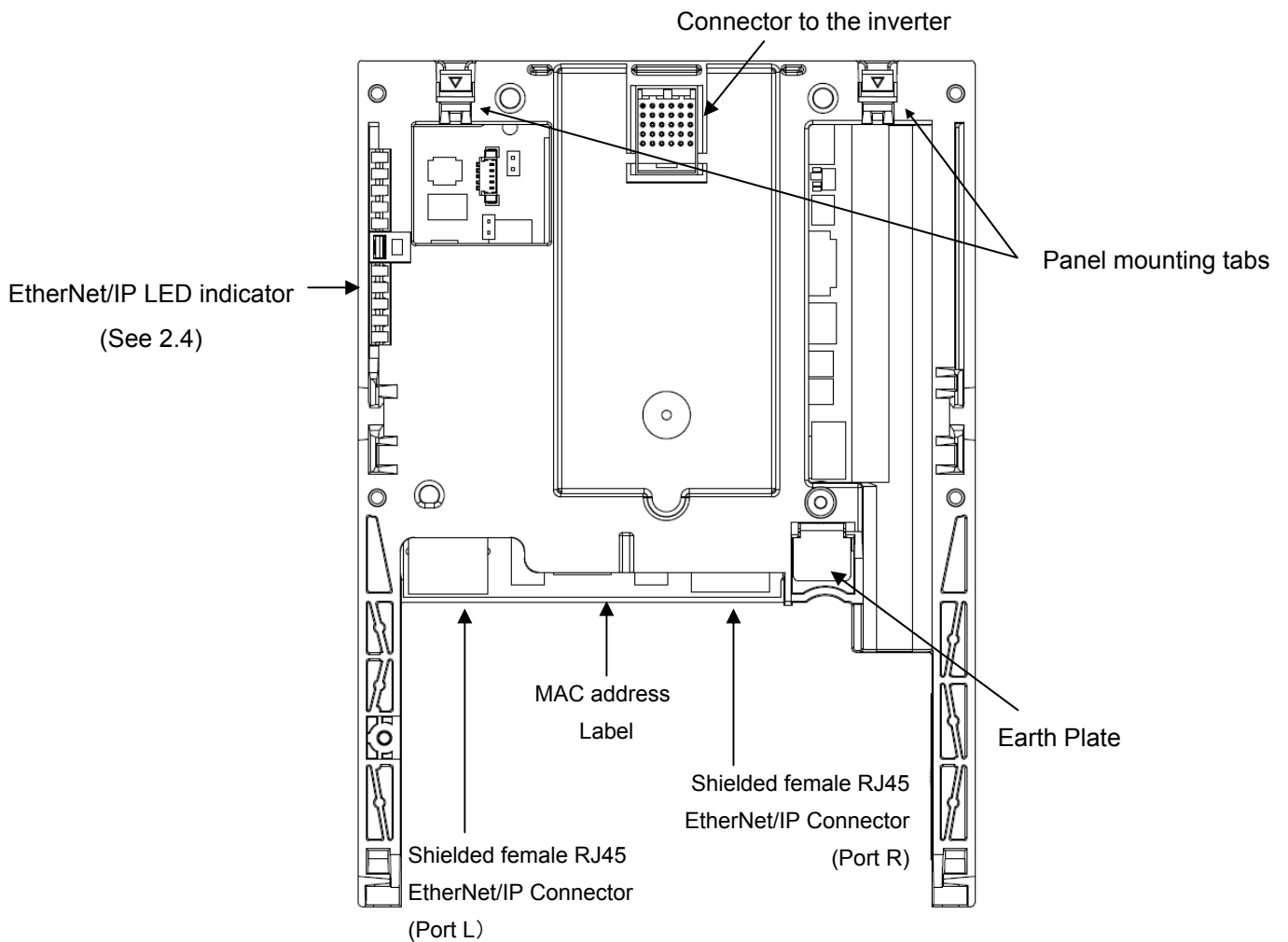

## 2.2. RJ45 connector pin layout

The EtherNet/IP™ unit is equipped with two shielded RJ45 connectors. The shielding is connected to the drive ground.

Use an STP (shielded twisted pair) Ethernet cable

The transmission speed is detected automatically by the unit (10 Mbps or 100 Mbps).

The card can operate in half duplex or full duplex mode, whether connected to a hub or a switch and regardless of the transmission speed (10 Mbps or 100 Mbps).

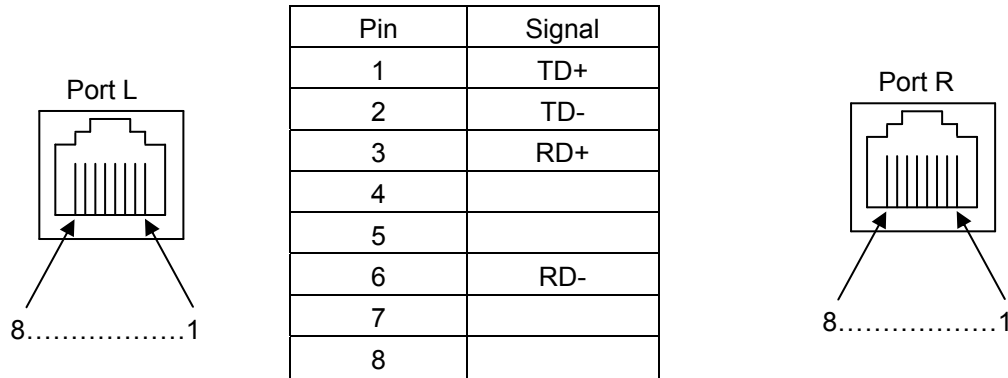

\* Fix a cable so that a communication connector may be not taken the weight of wire.

## 2.3. Example of connection to an EtherNet/IP

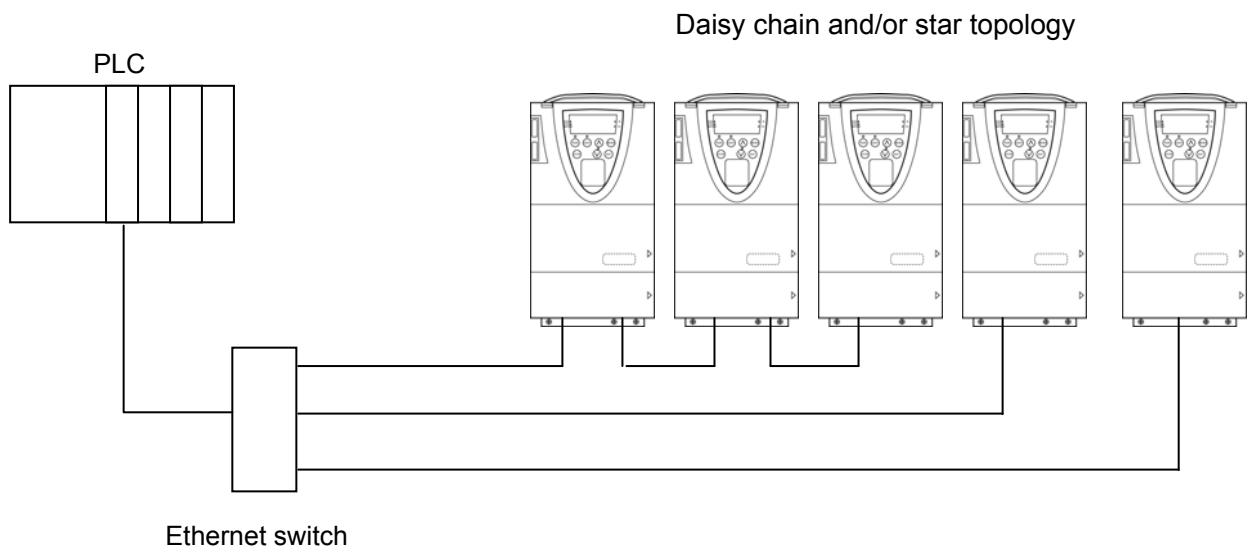

## 2.4. LED indicator

The LED shows the present status of the network and unit.

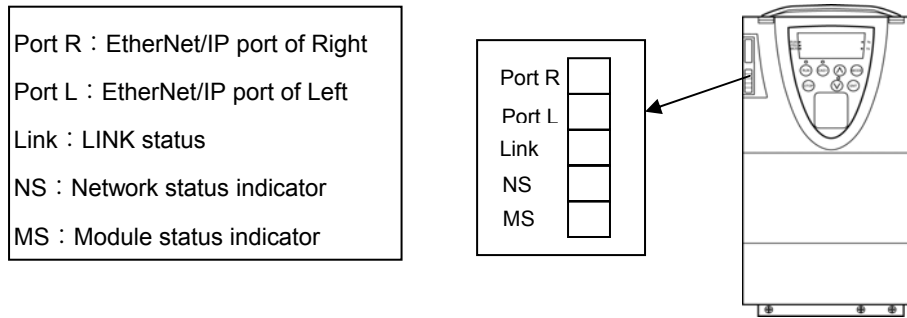

LED	Color/ state	Description
2.1 "Port R"	Off	No Link
	Flashing Green/Yellow	Power Up testing
	Green ON	Link at 100 Mbps
	Yellow ON	Link at 10 Mbps
	Green BLINK	Activity at 100 Mbps
	Yellow BLINK	Activity at 10 Mbps
2.2 "Port L"	Off	No Link
	Flashing Green/Yellow	Power Up testing
	Green ON	Link at 100 Mbps
	Yellow ON	Link at 10 Mbps
	Green BLINK	Activity at 100 Mbps
	Yellow BLINK	Activity at 10 Mbps
2.3 "Link"	Off	Physical connections unplugged - No IP address obtained
	Flashing Green/Red	Power Up testing
	Green ON	At least one port is connected and an IP address has been obtained
	Green flashing 3 times	All ports are unplugged, but the card has an IP address.
	Green flashing 4 times	Error: Duplicated IP address (*1)
	Green flashing 5 times	The card is performing a BOOTP or DHCP sequence
2.4 "NS"	Off	The device does not have an IP address or powered off.
	Flashing Green/Red	Power up testing.
	Green ON	The device has at least one established connection (even to the Message Router.)
	Green flashing	The device has not established connections, but has obtained an IP address.
	Red flashing	One or more of the connections in which this device is the target has timed out. This shall be left only if all time out connections are reestablished or if the device is reset.
	Red ON	The device has detected that its IP address is already in use (*1).
2.5 "MS"	Off	No power is supplied to the device.
	Flashing Green/Red	Power Up testing.
	Green ON	The device is operating correctly.
	Green flashing	The device has not been configured.
	Red flashing	The device has detected a communication error (E r B).
	Red ON	The device has detected an option unit error (E - 23) (*1).

(\*1) In case of duplicate IP Address, the LED 2.3. is green flashing 4 times, LED 2.4 and 2.5 are solid red.

## 3. Parameters

### 3.1. Communication parameters

Set up the inverter parameters as follows. It is necessary to reset the inverter to update the parameter. This option doesn't operate if these parameters are not correctly set.

Title	Communication No.	Function	Description	Default setting
<i>F00d</i>	0003	Command mode selection	0: Terminal input enabled 1: Operation panel input enabled (including LED/LCD option input) 2: 2-wire RS485 communication input 3: 4-wire RS485 communication input 4: Communication option input	0
<i>F00d</i>	0004	Frequency setting mode selection 1	1: VI/II (voltage/current input) 2: RR/S4 (potentiometer/voltage input) 3: RX (voltage input) 4: Operation panel input enabled (including LED/LCD option input) 5: 2-wire RS485 communication input 6: 4-wire RS485 communication input 7: Communication option input 8: Optional AI1 (differential current input) 9: Optional AI2 (voltage/current input) 10: UP/DOWN frequency 11: Optional RP pulse input 12: Optional high-speed pulse input 13: Optional binary/BCD input * *Unsupported option	1
<i>F576</i>	0576	IP mode (*1)	Use this parameter to select the IP address assignment method. 0:Manual 1:BOOTP 2:DHCP Refer to "3.2.2 Assigning IP addresses" for the details.	0
<i>F577- F580</i>	0577- 0580	IP address (*1)	IP address of the card These fields are <u>editable</u> when IP mode = 0. Refer to "3.2.2 Assigning IP addresses" for the details.	0,0,0,0
<i>F581- F584</i>	0581- 0584	IP Mask (*1)	Subnet mask of the card These fields are <u>editable</u> when IP mode = 0. Refer to "3.2.2 Assigning IP addresses" for the details.	0,0,0,0
<i>F585- F588</i>	0585- 0588	IP Gate (*1)	Gateway IP address of the card These fields are <u>editable</u> when IP mode = 0. Refer to "3.2.2 Assigning IP addresses" for the details.	0,0,0,0
<i>F784- F789</i>	0784- 0789	MAC address	MAC address display [XX-XX-XX-XX-XX-XX]	-
<i>F792- F799</i>	0792- 0799	DEVICE NAME (*1)	16 chars (These are 2 chars about one parameter.) The device name is required if the card uses DHCP to obtain its IP Address. Refer to "3.2.1 DEVICE NAME" for the details.	- (*2)
<i>F821</i>	0821	Rate Setting (*1)	This field is used to set the transmission speed and the transmission mode of the card. 0:Autodetect(default) 1:10Mbps Full 2:10Mbps Half 3:100Mbps Full 4:100Mbps Half	0





Title	Communication No.	Function	Description	Default setting
<i>F822</i>	0822	Actual Rate (L port)	This field displays the baud rate and the transmission mode currently used by the communication card. <b>(Display only)</b> 0:unconnected	-
<i>F823</i>	0823	Actual Rate (R port)	1:10Mbps Full 2:10Mbps Half 3:100Mbps Full 4:100Mbps Half	
<i>F824</i>	0824	Services	Enables web server and e-mail server * *Not used for this version. (Reserved)	0
<i>F831- F838</i>	0831- 0838	IOScanner Command data	0: No action 1: FA06 (Communication option command 1) 2: FA23 (Communication option command 2) 3: FA07 (Frequency command, 0.01Hz) 4: FA33 (Torque command, 0.01%) 5: FA50 (Terminal output) 6: FA51 (Analog output (FM) data from comm.) 7: FA52 (Analog output (AM) data from comm.) 8: F601 (Stall prevention level, %) 9: F441 (Power running torque limit 1 level, 0.01%) 10: F443 (Regenerative braking torque limit 1 level, 0.01%) 11: F460 (Speed loop proportional gain) 12: F461 (Speed loop stabilization coefficient)	0
<i>F841- F848</i>	0841- 0848	IOScanner Monitor data	0: No action 1: FD01 (Inverter status 1) 2: FD00 (Output frequency, 0.01Hz) 3: FD03 (Output current, 0.01%) 4: FD05 (Output voltage, 0.01%) 5: FC91 (Inverter alarm) 6: FD22 (PID feedback value, 0.01Hz) 7: FD06 (Input terminal status) 8: FD07 (Output terminal status) 9: FE36 (VI/II input) 10: FE35 (RR/S4 input) 11: FE37 (RX input) 12: FD04 (Input voltage (DC detection), 0.01%) 13: FD16 (Speed feedback (real-time value)) 14: FD18 (Torque, 0.01%) 15: FE60 (My monitor) 16: FE61 (My monitor) 17: FE62 (My monitor) 18: FE63 (My monitor) 19: F880 (Free notes) 20: FD29 (Input power, 0.01kW) 21: FD30 (Output power, 0.01kW) 22: FE14 (Cumulative operation time, 0.01=1 hour) 23: FE40 (FM terminal output monitor) 24: FE41 (AM terminal output monitor)	0
<i>F849</i>	0849	Communication2 time-out condition selection	0: Disconnection detection 1: When communication mode enable 2: 1+Driving operation	0
<i>F850</i>	0850	Disconnection detection extended time	0.0~100.0 sec.	0.0
<i>F851</i>	0851	Operation at communication error by disconnection	0: Inverter stop, communication command, frequency mode open (by <i>CNOd</i> , <i>FNOd</i> ) 1: None (continued operation) 2: Deceleration stop 3: Coast stop 4: Network error ( <i>ERRB</i> trip) 5: Preset speed operation (by <i>F852</i> setting)	0
<i>F852</i>	0852	Preset speed operation selection	0:None 1~15:Preset speed operation (by parameter setting)	0

Title	Communication No.	Function	Description	Default setting
<i>F856</i>	0856	Number of motor pole pair for communication	1: 2 poles 2: 4 poles 3: 6 poles 4: 8 poles 5: 10 poles 6: 12 poles 7: 14 poles 8: 16 poles	2
<i>F899</i>	0899	Network option reset setting	0:None 1:Reset option circuit board and inverter	0
-	FE66	Add-on option 1 CPU version (Under side option)	High byte is version. Low byte is revision. For example, When version number 1, and revision number 2 is, panel indication becomes with 1.02.	-
-	FE67	Add-on option 2 CPU version (Panel side)	The version of the option with it has equipped can be checked by using the function of <i>F710</i> to <i>F718</i> (standard monitor display selection). *For details, refer to the inverter instruction manual.	-

(\*1): This parameter is effective by reset. Please reset (power supply reset or *F899=1*) after changing a set point.

(\*2): The Factory default setting parameter (*Ⓛ 4P*) does not work for this parameter.

 <b>Warning</b>	
 Mandatory action	<ul style="list-style-type: none"> <li>▼ Set up “Network error detection (f849 - <i>F8529</i>.” parameters to stop the inverter when EtherNet/IP™ communication is deactivated.</li> <li>▼ When the parameters are changed, the power must be cycled to the VF-AS1 for the changes to take effect.</li> </ul>

## 3.2. The details of the parameter setting

### 3.2.1. DEVICE NAME (F 792-F 799)

The Device Name is possible to 16 characters to device name parameters.  
The device name is required if the card uses DHCP to obtain its IP Address.

Please set the setting of the device name according to the following rules.

1. The parameter is displayed by the hexadecimal number.
2. One parameter shows two ASCII codes.
3. The relation between the device name and the parameter is as follows.

Example for Device Name ='VFAS1-4007'

Parameter	Characters No.	Higher or Lower bit	Example	
			ASCII	Setting value
F 792	1	Higher bit	'V' (0x56)	0x5646
	2	Lower bit	'F' (0x46)	
F 793	3	Higher bit	'A' (0x41)	0x4153
	4	Lower bit	'S' (0x53)	
F 794	5	Higher bit	'1' (0x31)	0x312D
	6	Lower bit	'-' (0x2D)	
F 795	7	Higher bit	'4' (0x34)	0x3430
	8	Lower bit	'0' (0x30)	
F 796	9	Higher bit	'0' (0x30)	0x3037
	10	Lower bit	'7' (0x37)	
F 797	11	Higher bit	'(' (0x28)	0x2856
	12	Lower bit	'V' (0x56)	
F 798	13	Higher bit	'1' (0x31)	0x3135
	14	Lower bit	'5' (0x35)	
F 799	15	Higher bit	'4' (0x34)	0x3429
	16	Lower bit	')' (0x29)	

### 3.2.2. Assigning IP addresses (*F 5 7 6 - F 5 8 8*)

The drive needs following 3 IP addresses.

1. The drive IP address. (*F 5 7 7 - F 5 8 0*)
2. The subnet mask. (*F 5 8 1 - F 5 8 4*)
3. The gateway IP address. (*F 5 8 5 - F 5 8 8*)

These fields are editable when IP mode (*F 5 7 6*) = 0.

If the address has been given by a BOOTP or a DHCP server, these fields are read only.

- The new IP addresses are setting to the parameters (*F 5 7 7 - F 5 8 8*) after dynamic addressing by a BOOTP or DHCP server.

They can be provided by:

\*A BOOTP server (correspondence between the MAC address and the IP addresses).

\*Or a DHCP server (correspondence between Device Name and IP addresses).

If an IP address other than 0.0.0.0 has been entered, assignment using a server is disabled.

The address is assigned according to the IP mode parameter.

<i>F 5 7 6</i> : IP mode	Comments
0	The option module uses the address defined in <i>F 5 7 7-F 5 8 8</i> .
1	The option module receives its address from a BOOTP server.
2	The option module receives its address from a DHCP server. *Device name contains ( <i>F 7 9 2-F 7 9 9</i> ) a valid name.

IMPORTANT: The IP mode parameter may be modified according to the configuration control attribute of the TCP/IP interface object (CIP standard).

See page 33

### 3.2.3. Network error detection (*F 8 4 9 - F 8 5 2*)

▼ Display of trip information

*E r r 8* (Optional unit fault): Communication error

▼ Related parameter

[*F 8 4 9*: Communication2 time-out condition selection]

The range 0: Disconnection detection

1: When communication mode enable

2: 1+Driving operation

The condition of detecting the communication time-out is set.

[*F 8 5 0*: (Disconnection detection extended time)]

The range: 0.0 to 100.0 sec.

The waiting time from when a network error occurs can be adjusted. If a network error continues past the time set in *F 8 5 0*, it is recognized as a communication error and the operation of the inverter follows the setting of *F 8 5 1*.

When normal communication returns during the set time, a communication error is not displayed and operation is continued.

*-At I/O scanning and connected communication*

The time until time-out operates =

$RPI \times 4 \times 2^{\text{Connection Timeout Multiplier}} + F850$  (disconnection detection extended time)[0.1s]

RPI: Request Packet Interval

*-At Unconnected communication*

Time-out is not operating.

**[F851: Operation at communication error by disconnection]**

The range 0: Inverter stop, communication command, frequency mode open (by  $CnOd, FnOd$ )

1: None (continued operation)

2: Deceleration stop

3: Coast stop

4: Network error ( $E r r B$  trip)

5: Preset speed operation (by  $F852$  setting)

The operation of the inverter when the communication fault occurs can be specified.

**[F852: Preset speed operation selection]**

The range 0: None

1 to 15: Preset speed

The operation frequency of the inverter when the communication fault occurs can be specified. (Only when  $F851$  is set to 5)

### 3.2.4. Command data (*F831-F838*), Monitor data (*F841-F848*)

The outline is indicated about the setting item of parameter *F831 - F838* and *F841 - F848* in Instance 102/152 and 103/104 of use. Please refer to a communication functional description (VF-AS1: E6581315/VF-PS1: E6581413) for details.

#### 3.2.4.1. How to use Instance 102/152 and 103/104

Instance 102/152 and 103/104 choose a command or the monitor of the driving state by a menu of *F831 - F838* and *F841 - F848* and can perform the communication that is cyclic of EtherNet/IP™.

Example 1: Command transmitting by output Instance 102

When it runs by EtherNet/IP™ communication and wants to order you, please choose parameter FA06 (a communication option command) for command data (*F831 = 1* (FA06)).

For example, please set 0xC400 in FA06 when you want to send the command from an EtherNet/IP™ option and the availability of the frequency order and a driving order. (Please refer to next page)

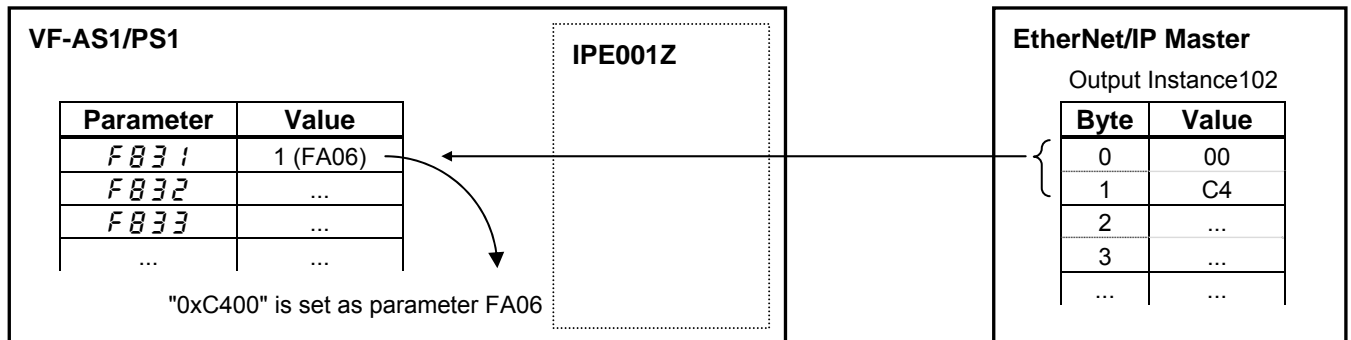

Example 2: State monitoring by the input instance 152.

When you want to monitor the output current, set "3 (FD03)" to parameter *F841*.

The value of the parameter FD03 specified as 0 and 1 byte of the input instance 152 with the parameter *F841* is inputted.

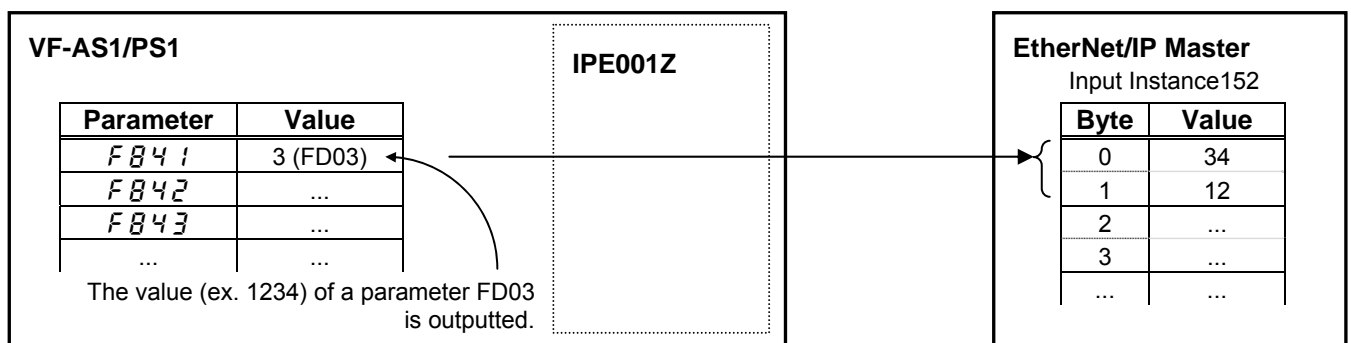

## 3.2.4.2. FA06 (Command word 1)

bit	Function	0	1	Note
0	Preset Speed operation frequencies 1	Preset speed operation is disabled or preset speed operation frequencies (1-15) are set by specifying bits for preset speed operation frequencies 1-4. (000: Preset speed operation OFF, 001-111: Setting of preset speed operation frequencies (1-15))		-
1	Preset Speed operation frequencies 2			
2	Preset Speed operation frequencies 3			
3	Preset Speed operation frequencies 4			
4	Motor selection (1 or 2) (THR 2 selection)	Motor 1 (THR1)	Motor 2 (THR2)	THR1: <i>tHr</i> THR2: <i>F173</i>
5	PI control	Normal operation	PI OFF	-
6	Acceleration/deceleration pattern selection (1 or 2) (AD2 selection)	Acceleration/deceleration pattern 1 (AD1)	Acceleration/deceleration pattern 2 (AD2)	AD1: <i>ACC, dec</i> AD2: <i>F500, F501</i>
7	DC braking	OFF	Forced DC braking	-
8	Jog	OFF	Jog run	-
9	Forward/reverse	Forward run	Reverse run	-
10	Run/stop	Stop	Run	-
11	Coast stop command	Standby	Coast stop	-
12	Emergency stop	OFF	Emergency stop	Always enabled, "E" trip
13	Fault reset	OFF	Reset	No data is returned from the inverter
14	Frequency selection priority	OFF	Enabled	Enabled regardless of the setting of <i>FNd</i>
15	Command selection priority	OFF	Enabled	Enabled regardless of the setting of <i>CNd</i>

Note: Set 0 to reserved bit.

### 3.2.4.3. FA23 (Command word 2)

bit	Function	0	1	Note
0	Control switching*	Speed Control	Torque Control	-
1	Electric power quantity reset	OFF	Reset	Electric power quantity (FE76, FE77) reset
2	(Reserved)	-	-	-
3	Braking request*	Normal	Forcibly braked	-
4	Preliminary excitation*	Normal	Enabled	-
5	Brake release (B)*	Brake applied	Brake released	-
6	Braking answer (BA)*	Brake applied	Brake released	-
7	Maximum deceleration forced stop	Normal	Enabled	-
8	Acceleration/ deceleration pattern selection 1*	00: Acceleration/ deceleration 1 01: Acceleration/ deceleration 2 10: Acceleration/ deceleration 3 11: Acceleration/ deceleration 4		Select Acceleration/ deceleration 1 – 4 by combination of two bits. AD1: <i>ACC, DEC</i> AD2: <i>F500, F501</i> AD3: <i>F510, F511*</i> AD3: <i>F514, F515*</i>
9	Acceleration/ deceleration pattern selection 2*			
10	V/F switching 1	00: V/F 1 01: V/F 2 10: V/F 3 * 11: V/F 4 *		Select V/F 1 – 4 by combination of two bits
11	V/F switching 2*			
12	Torque limit switching 1*	00: Torque limit 1 01: Torque limit 2 10: Torque limit 3 11: Torque limit 4		Select torque limit 1 – 4 by combination of two bits
13	Torque limit switching 2*			
14	Speed Gain 1/2*	Gain 1	Gain 2	Gain 1: <i>F460, F461</i> Gain 2: <i>F462, F463</i>
15	(Reserved)	-	-	-

Note: Set 0 to reserved bit.

\* These functions are reserved in VF-PS1.



### 3.2.4.4. FA07 (Frequency reference from comunciation option)

---

Frequency reference is set up by 0.01Hz unit and the hexadecimal number.

For example, when "Frequency reference" is set up to 80Hz, since the minimum unit is 0.01Hz,  
 $80 / 0.01 = 8000 = 0x1F40$  (Hex.)

### 3.2.4.5. FA33 (Torque reference from communication option)

---

Torque reference is set up by 0.01% unit and the hexadecimal number.

For example, when "torque reference" is set up to 50%, since the minimum unit is 0.01%,  
 $50 / 0.01 = 5000 = 0x1388$  (Hex.)

### 3.2.4.6. FA50 (Terminal output data from communication)

---

By setting up the data of the bit 0 - 6 of terminal output data (FA50) from communication, setting data (0 or 1) can be outputted to the output terminal.

Please select the functional number 92 - 105 as the selection (*F 130 - F 138, F 168, F 169*) of the output terminal function before using it.

bit	Output TB function name	0	1
0	Communication data 1 (Output TB select No.: 92, 93)	OFF	ON
1	Communication data 2 (Output TB select No.: 94, 95)		
2	Communication data 3 (Output TB select No.: 96, 97)		
3	Communication data 4 (Output TB select No.: 98, 99)		
4	Communication data 5 (Output TB select No.: 100, 101)		
5	Communication data 6 (Output TB select No.: 102, 103)		
6	Communication data 7 (Output TB select No.: 104, 105)		
7 to 15	(Reserved)	-	-

Note: Set 0 to reserved bit.

### 3.2.4.7. FA51 (Analog output (FM) data from communication)

---

The data set as the parameter FA51 can output to FM terminal.

The data adjustment range is 0 - 2047 (resolution: 11 bits).

Please select 31 (analog output for communication) as FM terminal meter selection parameter (*F 15 L*) before using it.

Please refer to "Meter setting and adjustment" Section of the VF-AS1/PS1 instruction manual for details.

### 3.2.4.8. FA52 (Analog output (AM) data from communication)

---

The data set as the parameter FA52 can output to AM terminal.

The data adjustment range is 0 - 2047 (resolution: 11 bits).

Please choose 31 (analog output for communication) as AM terminal meter selection parameter (*A 15 L*) before using it.

Please refer to "Meter setting and adjustment" Section of the VF-AS1/PS1 instruction manual for details.

### 3.2.4.9. FD01 (Inverter status (real time))

bit	Function	0	1	Note
0	Failure FL	No output	Output in progress	-
1	Failure	Not tripped	Tripped	The statuses include <i>r t r y</i> and trip retention status.
2	ALARM	No alarm	Alarm issued	-
3	(Undefined)	-	-	-
4	Motor selection (1 or 2) (THR 2 selection)	Motor 1 (THR1)	Motor 2 (THR2)	THR1: <i>t H r</i> THR2: <i>F 1 7 3</i>
5	PI control OFF	PI control permitted	PI control prohibited	-
6	Acceleration/ deceleration pattern selection (1 or 2)	Acceleration/ deceleration pattern 1 (AD1)	Acceleration/ deceleration pattern 2 (AD2)	AD1: <i>A C C, d E C</i> AD2: <i>F 5 0 0, F 5 0 1</i>
7	DC braking	OFF	Forced DC braking	-
8	Jog run	OFF	Jog run	-
9	Forward/ reverse run	Forward run	Reverse run	-
10	Run/stop	Stop	Run	-
11	Coast stop (ST=OFF)	ST=ON	ST=OFF	-
12	Emergency stop	Not emergency stop status	Emergency stop status	-
13	Standby ST=ON	Start-up process	Standby	Standby: Initialization completed, not failure stop status, not alarm stop status (MOFF, LL, forced stop or forced stop due to a momentary power failure), ST=ON, and RUN=ON
14	Standby	Start-up process	Standby	Standby: Initialization completed, not failure stop status, and not alarm stop status (MOFF, LL, forced stop or forced stop due to a momentary power failure)
15	Local/ Remote*	Remote	Local	-

Note: The bit described "Undefined" is unstable. Don't use the bit for the judgment.

\*\* This function is reserved in VF-AS1.

### 3.2.4.10. FD00 (Output frequency (real time))

The current output frequency is read into 0.01Hz of units and by the hexadecimal number. For example, when the output frequency is 80Hz, 0x1F40 (hexadecimal number) are read.

Since the minimum unit is 0.01%,

$$0x1F40 \text{ (Hex.)} = 8000 \text{ (Dec.)} * 0.01 = 80 \text{ (Hz)}$$

Also about the following parameters, these are the same as this.

- FD22 (Feedback value of PID (real time)) ..... Unit: 0.01Hz
- FD16 (PG feedback or Estimated speed (real time))..... Unit: 0.01Hz
- FD29 (Input power (real time))..... Unit: 0.01kW
- FD30 (Output power (real time)) ..... Unit: 0.01kW

### 3.2.4.11. FD03 (Output current (real time))

---

The output current is read into 0.01% of units and by the hexadecimal number.

For example, when the output current of the rated current 4.8A inverter is 50% (2.4A), 0x1388 (hexadecimal number) is read.

Since the minimum unit is 0.01%,

$$0x1388 \text{ (Hex.)} = 5000 \text{ (Dec.)} * 0.01 = 50 \text{ (\%)}$$

Also about the following parameters, these are the same as this.

- FD05 (Output voltage(real time))..... Unit: 0.01% (V)
- FD04 (Voltage at DC bus (real time))..... Unit: 0.01%(V)
- FD18 (Torque) ..... Unit: 0.01% (Nm)\*

\* When the motor information connected to the inverter set to the parameter (*F 4 0 5 - F 4 1 5*), torque monitor value "100%" is same as the rated torque of a motor in general.

### 3.2.4.12. FE36 (Analog input value VI/II)

---

The value inputted into the VI/II terminal is read.

The value range is 0x0 to 0x2710 (0 to 100.00 %).

- Also about FE35 (RR Input), it is the same as this parameter.

### 3.2.4.13. FE37 (RX Input)

---

The value inputted into the RX terminal is read.

The value range is 0xD8F0 to 0x2710(-100.00 to +100.00 %).

### 3.2.4.14. FE60 - FE63 (My Monitor)

---

Refer to the function Manual (E6581335).

### 3.2.4.15. FE14 (Cumulative run time)

---

The operated cumulative time is read by the hexadecimal number.

For example, when cumulative operation time is 18 hours, 0x12 (Hex) is read.

$$0x12 \text{ (Hex.)} = 18 \text{ (Dec., hour)}$$

### 3.2.4.16. FE40 (Analog output (FM))

---

The output value of FM terminal is read.

The value range is set to 0 to 10000 (0x2710).

- Also about FE41 (AM terminal output monitor), it is the same as this parameter.

**3.2.4.17. FC91 (Alarm code)**

bit	Function	0	1	Note
0	Over current alarm	Normal	Alarming	" <i>C</i> " blinking
1	Inverter over load alarm	Normal	Alarming	" <i>L</i> " blinking
2	Motor over load alarm	Normal	Alarming	" <i>L</i> " blinking
3	Over heat alarm	Normal	Alarming	" <i>H</i> " blinking
4	Over voltage alarm	Normal	Alarming	" <i>P</i> " blinking
5	Under voltage of main power	Normal	Alarming	-
6	(Undefined)	-	-	-
7	Under current alarm	Normal	Alarming	-
8	Over torque alarm	Normal	Alarming	-
9	OLr alarm	Normal	Alarming	-
10	Cumulative run-time alarm	Normal	Alarming	-
11	(Undefined)	-	-	-
12	(Undefined)	-	-	-
13	(Undefined)	-	-	-
14	At the time of the instant blackout, Forced deceleration/ stop	-	Decelerating, stopping	Related: <i>UwC</i> setting
15	An automatic stop during the lower limit frequency continuance	-	Decelerating, stopping	Related: <i>F256</i> setting

**3.2.4.18. FD06 (Input terminal board status)**

bit	TB Name	Function (Parameter)	0	1
0	F	Input TB Function select 1 ( <i>F 111</i> )	OFF	ON
1	R	Input TB Function select 2 ( <i>F 112</i> )		
2*	ST	Input TB Function select 3 ( <i>F 113</i> )		
3	RES	Input TB Function select 4 ( <i>F 114</i> )		
4	S1	Input TB Function select 5 ( <i>F 115</i> )		
5	S2	Input TB Function select 6 ( <i>F 116</i> )		
6	S3	Input TB Function select 7 ( <i>F 117</i> )		
7	S4	Input TB Function select 8 ( <i>F 118</i> )		
8	L1	Input TB Function select 9 ( <i>F 119</i> )		
9	L2	Input TB Function select 10 ( <i>F 120</i> )		
10	L3	Input TB Function select 11 ( <i>F 121</i> )		
11	L4	Input TB Function select 12 ( <i>F 122</i> )		
12	L5	Input TB Function select 13 ( <i>F 123</i> )		
13	L6	Input TB Function select 14 ( <i>F 124</i> )		
14	L7	Input TB Function select 15 ( <i>F 125</i> )		
15	L8	Input TB Function select 16 ( <i>F 126</i> )		

\* This function is reserved in VF-PS1.

**3.2.4.19. FD07 (Output terminal board status)**

bit	TB Name	Function (Parameter)	0	1
0	OUT1	Output TB Function select 1 ( <i>F 130</i> )	OFF	ON
1	OUT2	Output TB Function select 2 ( <i>F 131</i> )		
2	FL	Output TB Function select 3 ( <i>F 132</i> )		
3	OUT3	Output TB Function select 4 ( <i>F 133</i> )		
4	OUT4	Output TB Function select 5 ( <i>F 134</i> )		
5	R1	Output TB Function select 6 ( <i>F 135</i> )		
6	OUT5	Output TB Function select 7 ( <i>F 136</i> )		
7	OUT6	Output TB Function select 8 ( <i>F 137</i> )		
8	R2	Output TB Function select 9 ( <i>F 138</i> )		
9	R3	Output TB Function select 10 ( <i>F 168</i> )		
10	R4	Output TB Function select 11 ( <i>F 169</i> )		
11 - 15	(Undefined)	-	-	-

## 4. Objects

This section contains the object specifications for all EtherNet/IP™ objects currently supported by the “IPE001Z”. Table 1 outlines those objects covered:

Class Code		Object Class	Page
Hex.	Dec.		
0x01	1	Identity Object	21
0x02	2	Message Router Object	23
0x04	4	Assembly Object	24
0x06	6	Connection Manager Object	25
0x28	40	Motor Data Object	26
0x29	41	Control Supervisor Object	27
0x2A	42	AC/DC Drive Object	29
0x64	100	Parameter Object	30
0xF4	244	Port Object	31
0xF5	245	TCP/IP Interface Object	33
0xF6	246	Ethernet Link Object	34

**Table 1: Supported Objects**

For definitions of all data types referred to in these object specifications, refer to the ODVA EtherNet/IP™ Specifications. In general, however, the following are some of the most prevalent types:

SINT ..... Signed 8-bit integer value  
 USINT ..... Unsigned 8-bit integer value  
 BYTE ..... Bit string - 8-bits  
 INT ..... Signed 16-bit integer value  
 UINT ..... Unsigned 16-bit integer value  
 WORD ..... Bit string - 16-bits  
 UDINT ..... Unsigned 32-bit integer value

## 4.1. Identity Object (01 hex)

Class code 0x01. This object provides identification of IPE001Z and general information about the device.

### Class Attributes

Instance	Attribute	Access	Name	Data type	Details	Value
0	1	Get	Revision	UINT	Revision of this object	1
	2	Get	Max Instances	UINT	Maximum instance number of an object currently created in this class level of the device.	1
	3	Get	Number of Instances	UINT	Number of object instances currently created at this class level of the device.	1
	4	Get	Optional Attribute List	STRUCT of	List of optional instance attributes utilized in an object class implementation.	-
			number of attributes	UINT	Number of attributes in the optional attribute list.	03 00
			optional attributes	ARRAY of UINT	List of optional attribute numbers	0F 00 10 00 11 00
	6	Get	Max ID of class attributes	UINT	The attribute ID number of the last class attribute of the class definition implemented in the device.	7
7	Get	Max ID of instance attribute	UINT	The attribute ID number of the last instance attribute of the class definition implemented in the device.	17	

### Instance Attributes

Instance	Attribute	Access	Name	Data type	Details	Value
1	1	Get	Vendor ID	UINT	Identification of vendor by number	377
	2	Get	Device type	UINT	AC/DC Drive profile	02h
	3	Get	Product code	UINT	Identification of a product	31000
	4	Get	Revision	STRUCT of: USINT USINT	Revision of the item the Identity Object represents	-
			Major Revision	USINT		
			Minor Revision	USINT		
	5	Get	Status	WORD	See "Attribute 5 State Description"	-
	6	Get	Serial number	UDINT	4 last bytes of MAC Address	-
	7	Get	Product name	SHORT_ STRING	Human readable identification	7 IPE001Z
	15 (0xF)	Get/Set	Assigned_Name	STRINGI*	User assigned name	-
	16 (0x10)	Get/Set	Assigned_Description	STRINGI*	User assigned description	-
17 (0x11)	Get/Set	Geographic_Location	STRINGI*	User assigned location	-	

### Services

Service Code	Service Name	Supported		Description of Service
		Class	Instance	
01 hex	Get_Attribute_All	Yes	Yes	Read all attributes
05 hex	Reset	N/A	Yes	Reset module EtherNet/IP (1: Reset, 2: Out Of Box then Reset)
0E hex	Get_Attribute_Single	Yes	Yes	Read one attribute
10 hex	Set_Attribute_Single	N/A	Yes	Write one attribute

\*Note: STRINGI have the following format

Number of bytes	Means	Default for Assigned Name
1	Number of string	0x01
3	Language set	'eng' (0x65 0x6E 0x67)
1	EPATH	0xDA
2	Character Set	0x04 0x00
1	Length	16 (0x10)
Length	Value	'User Name String' (0x55 0x73 0x65 0x72 0x20 0x4E 0x61 0x6D 0x20 0x53 0x74 0x72 0x69 0x6E 0x67)

### Attribute 5 State Descriptions

Adapted from document [CIP] "THE CIP NETWORKS LIBRARY"

Bit	Called	Definition	
0	Owned	TRUE indicates the device (or an object within the device) has an owner. Within the Master/Slave paradigm the setting of this bit means that the Predefined Master/Slave Connection Set has been allocated to a master. Outside the Master/Slave paradigm the meaning of this bit is TBD. → <b>unused</b>	
1	Reserved, shall be 0	Reserved, shall be 0	
2	Configured.	TRUE indicates the application of the device has been configured to do something different than the "out-of-box" default. This shall not include configuration of the communications.	
3	Reserved, shall be 0	Reserved, shall be 0	
4-7	Extended Device Status	0	Self-Testing or Unknown
		1	Firmware Update in Progress
		2	At least one faulted I/O connection
		3	No I/O connections established
		4	Non-Volatile Configuration bad
		5	Major Fault – either bit 10 or bit 11 is true (1)
		6	At least one I/O connection in run mode
		7	At least one I/O connection established, all in idle mode
		8	Reserved, shall be 0
9-15	Vendor/Product specific → <b>unused</b>		
8	Minor Recoverable Fault	TRUE indicates the device detected a problem with itself, which is thought to be recoverable. The problem does not cause the device to go into one of the faulted states.	
9	Minor Unrecoverable Fault.	TRUE indicates the device detected a problem with itself, which is thought to be unrecoverable. The problem does not cause the device to go into one of the faulted states.	
10	Major Recoverable Fault.	TRUE indicates the device detected a problem with itself, which caused the device to go into the "Major Recoverable Fault" state.	
11	Major Unrecoverable Fault	TRUE indicates the device detected a problem with itself, which caused the device to go into the "Major Unrecoverable Fault" state.	
12-15	Reserved, shall be 0	Reserved, shall be 0	

## 4.2. Message Router Object (02 hex)

*Class code 0x02.* The Message Router Object provides a messaging connection point through which a Client may address a service to any object class or instance residing in the physical device.

### Class Attributes available

Instance	Attribute ID	Access	Name	Data type	Value
0	1	Get	Revision	UINT	1
	2	Get	Max Instances	UINT	1
	3	Get	Number of Instances	UINT	1
	6	Get	Max ID of class attributes	UINT	7
	7	Get	Max ID of instance attribute	UINT	2

### Instance Attribute available

Instance	Attribute ID	Access	Name	Data type	Value	Details
1	1	Get	Object list : -Number -Classes	Struct of: UINT UINT[]	0B 00 01 00 02 00 04 00 06 00 F4 00 F5 00 F6 00 28 00 29 00 2A 00 64 00	List object supported Number of class supported List of supported code class
	2	Get	Number available	UINT	8	Number of maximum connections supported

### Services

Service Code	Service Name	Supported		Description of Service
		Class	Instance	
01 hex	Get_Attribute_All	Yes	Yes	Read all attributes
0E hex	Get_Attribute_Single	Yes	Yes	Read one attribute



### 4.3. Assembly Object (04 hex)

Class code 0x04. The Assembly Object binds attributes of multiple objects, which allows data to or from each object to be sent or received over a single connection. Assembly objects can be used to bind input data or output data. The terms "input" and "output" are defined from the network's point of view. An input will produce data on the network and an output will consume data from the network

#### Class Attributes available

Instance	Attribute ID	Access	Name	Data type	Value	Details
0	1	Get	Revision	UINT	2	-
	2	Get	Max Instances	UINT	152	-
	3	Get	Number of Instances	UINT	16	-
	6	Get	Max ID of class attributes	UINT	7	-
	7	Get	Max ID of instance attribute	UINT	4	Assembly objects are static

#### Instance Attribute available

Instance	Attribute ID	Access	Name	Data type	Value	Details
See below	3	Get/Set*	Data			Settable Only on Output Assembly. See below

#### Output Assembly:

Instance	Type	Size	Page
20	CIP basic speed control output	2 words (4 bytes)	37
21	CIP extended speed control output	2 words (4 bytes)	38
22	CIP speed and torque control output	3 words (6 bytes)	39
23	CIP extended speed and torque control output	3 words (6 bytes)	39
100	Native drive output	2 words (4 bytes)	40
101	Native drive output	4 words (8 bytes)	42
102	Native drive output	6 words (12 bytes)	44
103	Allen-Bradley® drive output	2 to 10 words (4 to 20 bytes)	45

#### Input Assembly:

Instance	Type	Size	Page
70	CIP basic speed control input	2 words (4 bytes)	37
71	CIP extended speed control input	2 words (4 bytes)	38
72	CIP speed and torque control input	3 words (6 bytes)	39
73	CIP extended speed and torque control input	3 words (6 bytes)	39
104	Allen-Bradley® drive input	2 to 10 words (4 to 20 bytes)	46
150	Native drive input	2 words (4 bytes)	40
151	Native drive input	4 words (8 bytes)	42
152	Native drive input	6 words (12 bytes)	44

#### Services

Service Code	Service Name	Supported		Description of Service
		Class	Instance	
01 hex	Get_Attribute_All	N/A	Yes	Read all attributes
0E hex	Get_Attribute_Single	Yes	Yes	Read one attribute

## 4.4. Connection Manager Object (06 hex)

Class code 0x06. Use this object for connection and connectionless communications, including establishing connections across multiple subnets.

### Class Attributes available

Instance	Attribute ID	Access	Name	Data type	Value
0	1	Get	Revision	UINT	1
	2	Get	Max Instances	UINT	1
	3	Get	Number of Instances	UINT	1
	4	Get	Optional Attribute List	STRUCT of	08 00 01 00 02 00 03 00 04 00 05 00 06 00 07 00 08 00
	6	Get	Max ID of class attributes	UINT	7
	7	Get	Max ID of instance attribute	UINT	8

### Instance 1 Attribute available

Instance	Attribute ID	Access	Name	Data type	Details
1	1	Get	Open Requests	UINT	Number of Forward Open service requests received.
	2	Get	Open Format Rejects	UINT	Number of Forward Open service requests which were rejected due to bad format.
	3	Get	Open Resources Rejects	UINT	Number of Forward Open service requests which were rejected due to lack of resources.
	4	Get	Open Other Rejects	UINT	Number of Forward Open service requests which were rejected for reasons other than bad format or lack of resources.
	5	Get	Close Requests	UINT	Number of Forward Close service requests received.
	6	Get	Close Format Requests	UINT	Number of Forward Close service requests which were rejected due to bad format.
	7	Get	Close Other Requests	UINT	Number of Forward Close service requests which were rejected for reasons other than bad format.
	8	Get	Connection Timeouts	UINT	Total number of connection timeouts that have occurred in connections controlled by this Connection Manager

### Services

Service Code	Service Name	Supported		Description of Service
		Class	Instance	
01 hex	Get_Attribute_All	Yes	Yes	Read all attributes
0E hex	Get_Attribute_Single	Yes	N/A	Read one attribute
10 hex	Set_Attribute_Single	N/A	Yes	Write one attribute
4E hex	Forward_Close	N/A	Yes	Closes a connection
54 hex	Forward_Open	N/A	Yes	Opens a connection, maximum data size is 511 bytes
5B hex	Large_Forward_Open	N/A	Yes	Opens a connection, maximum data size is 65535 bytes

\*The timeout is not detected under non-connection communication.

## 4.5. Motor Data Object (28 hex)

Class code 0x28. This object serves as a database for motor parameters.

### Class Attributes available

Instance	Attribute ID	Access	Name	Data type	Value
0	1	Get	Revision	UINT	1
	2	Get	Max Instances	UINT	1
	6	Get	Max ID of class attributes	UINT	7
	7	Get	Max ID of instance attribute	UINT	15

### Instance 1 Attribute available

Instance	Attribute ID	Access	Name	Data type	Details
1	1	Get	AttrNb	UINT	number of attributes supported
	2	Get	AttrList	List of USINT	List of attributes supported
	3	Get	MotorType	USINT	According to $P \underline{L}$ : If pt = 6 -> = 3 (synchronous motor) else -> = 7 (motor cage)
	6	Get/Set	RatedCurrent	UINT	Motor Rated Current [100mA]
	7	Get/Set	RatedVoltage	UINT	Motor Rated Volt [V]
	8	Get/Set	RatedPower	UDINT	Motor rated Power [W]
	9	Get/Set	RatedFreq	UINT	Motor Base Freq [Hz]
	12	Get	PoleCount	UINT	Pole Count*1
	15	Get/Set	BaseSpeed	UINT	Motor Base Speed [ $\text{min}^{-1}$ ]

\*1 Need set the parameter  $F \underline{B} \underline{5} \underline{6}$  (Motor pairs of poles for communication).

### Services

Service Code	Service Name	Supported		Description of Service
		Class	Instance	
0E hex	Get_Attribute_Single	Yes	Yes	Read one attribute
10 hex	Set_Attribute_Single	N/A	Yes	Write one attribute

## 4.6. Control Supervisor Object (29 hex)

Class code 0x29. This object models all the management functions for devices within the “Hierarchy of Motor Control Devices”. The behavior of motor control devices is described by the State Transition Diagram.

### Class Attributes available

Instance	Attribute ID	Access	Name	Data type	Value
0	1	Get	Revision	UINT	1
	2	Get	Max Instances	UINT	1
	6	Get	Max ID of class attributes	UINT	7
	7	Get	Max ID of instance attribute	UINT	15

### Instance 1 Attribute available

Instance	Attribute ID	Access	Name	Data type	Details
1	1	Get	AttrNb	UINT	number of attributes supported
	2	Get	AttrList	List of USINT	List of attributes supported
	3	Get/Set	Run Fwd	BOOL	On edge
	4	Get/Set	Run Rev	BOOL	On edge
	5	Get/Set	NetCtrl	BOOL	0: Local Control(default) 1: Network Control
	6	Get	State	USINT	0: N/A, 1: Startup, 2: Not_Ready, 3: Ready, 4: Enabled, 5: Stopping, 6: Fault_Stop, 7: Faulted
	7	Get	Running Fwd	BOOL	
	8	Get	Running Rev	BOOL	
	9	Get	Ready	BOOL	
	10	Get	Faulted	BOOL	
	11	Get	Warning	BOOL	
	12	Get/Set	FaultRst	BOOL	On edge
	15	Get	CtrlFromNet	BOOL	0: Local Control 1: Network Control

### Services

Service Code	Service Name	Supported		Description of Service
		Class	Instance	
05 hex	Reset	N/A	Yes	Reset drive
0E hex	Get_Attribute_Single	Yes	Yes	Read one attribute
10 hex	Set_Attribute_Single	N/A	Yes	Write one attribute

#### 4.6.1. Run/Stop Event Matrix

Run1	Run2	Trigger Event	Run Type
0	0	Stop	No Action
0 -> 1	0	Run	Run1
0	0 -> 1	Run	Run2
0 -> 1	0 -> 1	No Action	No Action
1	1	No Action	No Action
1 -> 0	1	Run	Run2
1	1 -> 0	Run	Run1

#### 4.6.2. Control Supervisor State Transition Diagram

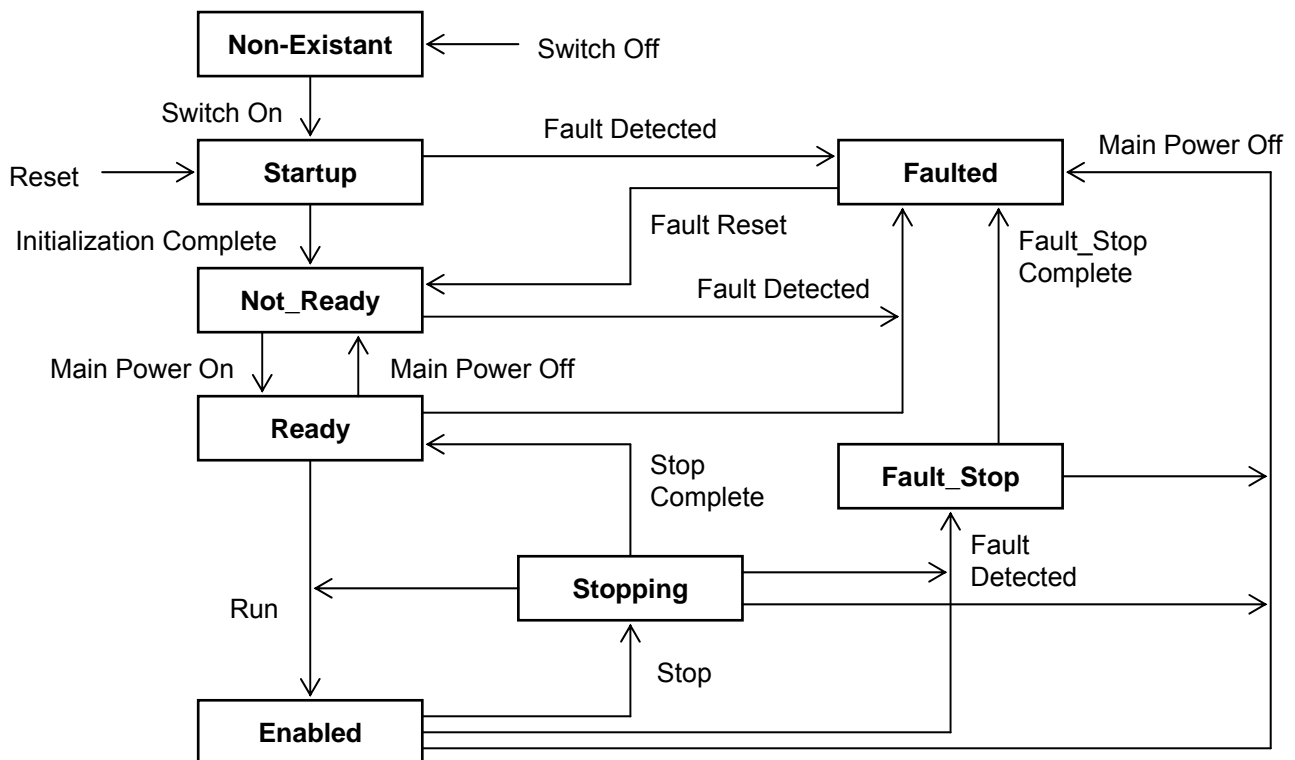

## 4.7. AC/DC Drive Object (2A hex)

Class code 0x2A. This object models the functions specific to an AC or DC Drive. e.g. speed ramp, torque control etc.

### Class Attributes available

Instance	Attribute ID	Access	Name	Data type	Value
0	1	Get	Revision	UINT	1
	2	Get	Max Instances	UINT	1
	6	Get	Max ID of class attributes	UINT	7
	7	Get	Max ID of instance attribute	UINT	46

### Instance 1 Attribute available

Instance	Attribute ID	Access	Name	Data type	Value	Details
1	1	Get	AttrNb	UINT	19	number of attributes supported
	2	Get	AttrList	List of USINT	03 04 06 07 08 09 0A 0B 0C 0F 12 13 14 15 18 1A 1C 1D 2E	List of attributes supported
	3	Get	AtReference	BOOL	-	At Reference
	4	Get/Set	NetRef	BOOL	-	Net Reference
	6	Get	Drive mode	USINT	*1	Drive Mode
	7	Get	SpeedActual	INT	-	Actual Speed
	8	Get/Set	SpeedRef	INT	-	Reference Speed
	9	Get	CurrentActual	INT	-	Drive Current
	10	Get/Set	CurrentLimit	INT	-	Drive Current Limit
	11	Get	Torque Actual	INT	-	Drive Actual Torque
	12	Get/Set	TorqueRef	INT	-	Reference Torque
	15	Get	Actual power	INT	-	Drive Power
	18	Get/Set	AccelTime	UINT	-	Drive Acceleration
	19	Get/Set	DecelTime	UINT	-	Drive Deceleration
	20	Get/Set	LowSpdLimit	UINT	-	Drive minimum speed
	21	Get/Set	HighSpdLimit	UINT	-	Drive maximum speed
	24	Get/Set	Torque scaling	SINT	0	Torque scaling factor for Attr12
	26	Get	Power scaling	SINT	5	Power scaling factor for Attr15
	28	Get/Set	TimeScale	SINT	7	Time scaling factor for Attr18 and 19
	29	Get	RefFromNet	BOOL	-	Reference From Net
46	Get	HoursOn	DINT	-	Hours On(Running)	

### Services

Service Code	Service Name	Supported		Description of Service
		Class	Instance	
0E hex	Get_Attribute_Single	Yes	Yes	Read one attribute
10 hex	Set_Attribute_Single	N/A	Yes	Write one attribut

## 4.8. Application Objects (64 hex)

Class code 0x64. This object provides VF-AS1/PS1's Parameter access.

Range Address accessed:

Input Instance	Real Logical address in Drive accessed
0x4000-0x5FFF	0x0000-0x1FFF
0x6000-0x7FFF	0xE000-0xFFFF

### Class Attributes available

Instance	Attribute ID	Access	Name	Data type	Value	Details
0	1	Get	Revision	UINT	1	
	2	Get	Max Instances	UINT	0x7FFF	
	6	Get	Max ID of class attributes	UINT	7	
	7	Get	Max ID of instance attribute	UINT	3	

### Instance 1 Attribute available

Instance	Attribute ID	Access	Name	Data type	Details
See below	3	Get/Set	parameter	UINT	Parameter corresponding to the Instance address

### Services

Service Code	Service Name	Supported		Description of Service
		Class	Instance	
0E hex	Get_Attribute_Single	Yes	Yes	Read one attribute
10 hex	Set_Attribute_Single	N/A	Yes	Write one attribut

Note: The service "Set\_Attribute\_Single" writes the parameter into the RAM and the EEPROM of the drive.

Attribute ID of all parameters are 3. Moreover, about the instance ID of each parameter, it becomes "parameter communication number + 0x4000".

In the case of the parameter from which a communication number begins in "F", it becomes "parameter communication number - 0x8000 (same as bit15 set to 0)".

About the details of the contents of a parameter, please refer to a VF-AS1/PS1 instructions manual.

Example 1.

In case of Basic parameter "CMOd - Command mode selection",  
Communication No: **0003** -> Instance ID: **4003**

Example 2.

In case of Extended parameter "F268 - Updown frequency default value",  
Communication No: **0268** -> Instance ID: **4268**

Example 3.

In case of Monitor parameter "FE03 - Output current",  
Communication No: **FE03** -> Instance ID: **7E03**

\* Monitor parameter can access "Get" only.

For example, when "Acc. time" is set to 5 sec., since the minimum unit is 0.1s,

$$5 / 0.1 = 50 = 0x0032 \text{ (Hex.)}$$

Since the communication number of "Acc. time" is "0009", it writes "0x0032" in instance ID "4009."

Moreover, when the "highest frequency" is read, "0x1F40" is read.

$$0x1F40 = 8000 \text{ (Dec.)}$$

Since the minimum unit is 0.01Hz,

$$8000 * 0.01 = 80\text{Hz}$$

## 4.9. Port Object (F4 hex)

*Class code 0xF4:* The Port Object enumerates the CIP ports present on the device. One instance exists for each CIP port.

### Class Attributes available

Instance	Attribute ID	Access	Name	Data type	Value	Details
0	1	Get	Revision	UINT	1	
	2	Get	Max Instances	UINT	2	
	3	Get	Number of Instances	UINT	2	
	6	Get	Max ID of class attributes	UINT	9	
	7	Get	Max ID of instance attribute	UINT	7	
	8	Get	Entry Port	UINT	2	Returns the instance of the Port Object that describes the port through which this request entered the device.
	9	Get	Port Instance Info	ARRAY of STRUCT of	00 00 00 00 04 00	Array of structures containing instance attributes 1 and 2 from each instance.
			Port Type	UINT	02 00	
			Port Number	UINT	04 00 03 00	

Note: Attribute 9

00 00 00 00 -> port type = 0 (Connection terminated) / instance number = 0 (class)

04 00 02 00 -> port type = 4 (EtherNet/IP Port) / port number = 2

04 00 03 00 -> port type = 4 (EtherNet/IP Port) / port number = 3

### Instance 1 Attribute available

Instance	Attribute ID	Access	Name	Data type	Value	Details
1	1	Get	Port Type	UINT	4	Enumerate the type of port. (4 = TCP/IP)
	2	Get	Port Number	UINT	2	CIP port associated with this port (identify each communication port). Value '1' is reserved.
	3	Get	Link Object	STRUCT of: UINT Padded EPATH	02 00 20 F5 24 01	Identify Object attached to this port. For Ethernet/IP™, this path corresponds to TCP/IP Interface object.
	4	Get	Port Name	SHORT_ STRING	0A 4C 65 66 74 20 50 6F 72 74 00 'Left Port'	String which names the port.
	7	Get	Node address	Padded EPATH	10 00	Node number of this device on port. (10 00 indicates 0 length node address)

### Instance 2 Attribute available

Instance	Attribute ID	Access	Name	Data type	Value	Details
2	1	Get	Port Type	UINT	4	Enumerate the type of port.
	2	Get	Port Number	UINT	3	CIP port associated with this port (identify each communication port).
	3	Get	Link Object	STRUCT of: UINT Padded EPATH	02 00 20 F5 24 02	Identify Object attached to this port. For Ethernet/IP™, this path corresponds to TCP/IP Interface object.
	4	Get	Port Name	SHORT_ STRING	0B 52 69 67 68 74 20 50 6F 72 74 00 'Right Port'	String which names the port.



Instance	Attribute ID	Access	Name	Data type	Value	Details
	7	Get	Node address	Padded EPATH	10 00	Node number of this device on port.

### Services

Service Code	Service Name	Supported		Description of Service
		Class	Instance	
01 hex	Get_Attribute_All	Yes	Yes	Read all attributes
0E hex	Get_Attribute_Single	Yes	Yes	Read one attribute
10 hex	Set_Attribute_Single	Yes	N/A	Write one attribute

## 4.10. TCP/IP interface (F5 hex)

Class code 0xF5: The TCP/IP Interface Object provides the mechanism to configure a device's TCP/IP network interface.

### Class Attributes available

Instance	Attribute ID	Access	Name	Data type	Value
0	1	Get	Revision	UINT	1
	2	Get	Max Instances	UINT	1
	3	Get	Number of Instances	UINT	1
	6	Get	Max ID of class attributes	UINT	7
	7	Get	Max ID of instance attribute	UINT	6

### Instance 1 Attribute available

Instance	Attribute ID	Access	Name	Data type	Details
1	1	Get	Status	DWORD	0 = The Interface Configuration attribute has not been configured. 1 = The Interface Configuration attribute contains valid configuration.
	2	Get	Configuration capability	DWORD	Bit 0 = 1 (TRUE) shall indicate the device is capable of obtaining its network configuration via BOOTP. Bit 1 = 1 (TRUE) shall indicate the device is capable of resolving host names by querying a DNS server. Bit 2 = 1 (TRUE) shall indicate the device is capable of obtaining its network configuration via DHCP. Bit 3 = 1 (TRUE) shall indicate the device is capable of sending its host name in the DHCP request. Bit 4 = 1 (TRUE) shall indicate the Interface Configuration attribute is settable. Bit 5-31 : reserved
	3	Get/Set	Configuration control	DWORD	Bits 0-3 Start-up configuration 0 = The device shall use the interface configuration values previously stored. 1 = The device shall obtain its interface configuration values via BOOTP. 2 = The device shall obtain its interface configuration values via DHCP upon start-up. 3-15 = Reserved for future use. Bit 4 = 1 (TRUE), the device shall resolve host names by querying a DNS server. Bit 5-31 : reserved
	4	Get	Physical Link Object	STRUCT of UINT EPATH	Path Size Path: Logical segments identifying the physical link object Example [20][F6][24][01] : [20] = 8 bit class segment type; [F6] = Ethernet Link Object class; [24] = 8 bit instance segment type; [01] = instance 1.
	5	Get/Set	Interface Configuration	STRUCT of UDINT UDINT UDINT UDINT UDINT STRING	IP address (0 : no address configured) Network Mask (0 : no Network mask configured) Gateway address (0 : no address configured) Name server address (0 : no address configured) Name server address 2 (0 : no address configured) Domain Name
	6	Get/Set	Host Name	STRING	Reads or writes the name of Drive.

### Services

Service Code	Service Name	Supported		Description of Service
		Class	Instance	
01 hex	Get_Attribute_All	Yes	Yes	Read all attributes
02 hex	Set_Attribute_All	N/A	Yes	Write all attributes
0E hex	Get_Attribute_Single	Yes	Yes	Read one attribute
10 hex	Set_Attribute_Single	Yes	Yes	Write one attribute

## 4.11. Ethernet link (F6 hex)

*Class code 0xF6:* The Ethernet Link Object maintains link-specific counters and status information for a Ethernet 802.3 communications interface.

### Class Attributes available

Instance	Attribute ID	Access	Name	Data type	Value
0	1	Get	Revision	UINT	3
	2	Get	Max Instances	UINT	2
	3	Get	Number of Instances	UINT	2
	6	Get	Max ID of class attributes	UINT	7
	7	Get	Max ID of instance attribute	UINT	10

### Instance 1 and 2 Attribute available

Instance	Attribute ID	Access	Name	Data type	Details
1	1	Get	Interface Speed	UDINT	Interface speed currently in use 0 : indeterminate (Autobaudrate) 10: 10Mbps 100: 100Mbps
	2	Get	Interface Flags	DWORD	<p>Bit 0 : Link Status Indicates whether or not the Ethernet 802.3 communications interface is connected to an active network. 0 indicates an inactive link; 1 indicates an active link.</p> <p>Bit 1 : Half/Full Duplex Indicates the duplex mode currently in use. 0 indicates the interface is running half duplex; 1 indicates full duplex.</p> <p>Bit 2-4 : Negotiation Status 0 = Auto-negotiation in progress. 1 = Auto-negotiation and speed detection failed. 2 = Auto negotiation failed but detected speed. Duplex was defaulted. 3 = Successfully negotiated speed and duplex. 4 = Auto-negotiation not attempted. Forced speed and duplex.</p> <p>Bit 5 : Manual Setting Requires Reset. 0 indicates the interface can activate changes to link parameters (auto-negotiate, duplex mode, interface speed) automatically. 1 indicates the device requires a Reset service be issued to its Identity Object in order for the changes to take effect.</p> <p>Bit 6: Local Hardware Fault. 0 indicates the interface detects no local hardware fault; 1 indicates a local hardware fault is detected. The meaning of this is product-specific.</p> <p>Bit 7-31 Reserved Shall be set to zero</p>
	3	Get	Physical Address	ARRAY of 6 USINTs	MAC layer address
	6	Get/Set	Interface Control	STRUCT of:	Force auto negotiate, duplex half/ full and speed 10/ 100
			Control Bits	WORD	Interface Control Bits bit0 = Auto-Negotiated Enabled bit1 = Duplex Full Enabled
			Forced Interface Speed	UINT	Speed at which the interface shall be forced to operate speed 10 or 100

Instance	Attribute ID	Access	Name	Data type	Details
1	10	Get	Interface Label	SHORT_STRING	Human readable identification Instance 1: 'Left Port' Instance 2: 'Right Port'

### Services

Service Code	Service Name	Supported		Description of Service
		Class	Instance	
01 hex	Get_Attribute_All	N/A	Yes	Read all attributes
0E hex	Get_Attribute_Single	Yes	Yes	Read one attribute
10 hex	Set_Attribute_Single	Yes	Yes	Write one attribute
4C hex	Get_And_Clear	N/A	Yes	Same than Get_Attribute_Single

---

## 5. Configuration of the assemblies

---



---

### 5.1. List of Assembly Object Instance

---

#### Output Instance

Instance name	ID (Hex)	Size
CIP basic speed control output	20(14H)	2 words (4 bytes)
CIP extended speed control output	21(15H)	2 words (4 bytes)
CIP speed and torque control output	22(16H)	3 words (6 bytes)
CIP extended speed and torque control output	23(17H)	3 words (6 bytes)
Native drive output	100(64H)	2 words (4 bytes)
Native drive output	101(65H)	4 words (8 bytes)
Native drive output	102(66H)	6 words (12 bytes)
Allen-Bradley® drive output	103(67H)	2 to 10 words (4 to 20 bytes)

#### Input Instance

Instance name	ID (Hex)	Size
CIP basic speed control input	70(46H)	2 words (4 bytes)
CIP extended speed control input	71(47H)	2 words (4 bytes)
CIP speed and torque control input	72(48H)	3 words (6 bytes)
CIP extended speed and torque control input	73(49H)	3 words (6 bytes)
Native drive input	150(96H)	2 words (4 bytes)
Native drive input	151(97H)	4 words (8 bytes)
Native drive input	152(98H)	6 words (12 bytes)
Allen-Bradley® drive input	104(68H)	2 to 10 words (4 to 20 bytes)

### 5.1.1. Instance 20: CIP basic speed control output

#### Instance 20 mapping

Byte	Bit 7	Bit 6	Bit 5	Bit 4	Bit 3	Bit 2	Bit 1	Bit 0
0	-	-	-	-	-	Fault reset	-	Run forward
1	-							
2	Drive Speed Reference $\text{min}^{-1}$ (Low byte) *							
3	Drive Speed Reference $\text{min}^{-1}$ (High byte) *							

### 5.1.2. Instance 70: CIP basic speed control input

#### Instance 70 mapping

Byte	Bit 7	Bit 6	Bit 5	Bit 4	Bit 3	Bit 2	Bit 1	Bit 0
0	-	-	-	-	-	Running forward	-	Faulted
1	-							
2	Drive Actual Speed $\text{min}^{-1}$ (Low byte)							
3	Drive Actual Speed $\text{min}^{-1}$ (High byte)							

#### Examples of Instance 20/70

##### (1) Stop

Instance	Byte	15	14	13	12	11	10	9	8	7	6	5	4	3	2	1	0	Hex.
Output Instance 20	1, 0	0	0	0	0	0	0	0	0	0	0	0	0	0	0	0	0	0x0000
	3, 2	-	-	-	-	-	-	-	-	-	-	-	-	-	-	-	-	-
Input Instance 70	1, 0	0	0	0	0	0	0	0	0	0	0	0	0	0	0	0	0	0x0000
	3, 2	0	0	0	0	0	0	0	0	0	0	0	0	0	0	0	0	0x0000

##### (2) Forward running 1800 $\text{min}^{-1}$

Instance	Byte	15	14	13	12	11	10	9	8	7	6	5	4	3	2	1	0	Hex.
Output Instance 20	1, 0	0	0	0	0	0	0	0	0	0	0	0	0	0	0	0	1	0x0001
	3, 2	0	0	0	0	0	1	1	1	0	0	0	0	1	0	0	0	0x0708
Input Instance 70	1, 0	0	0	0	0	0	0	0	0	0	0	0	0	0	1	0	0	0x0004
	3, 2	0	0	0	0	0	1	1	1	0	0	0	0	1	0	0	0	0x0708

##### (3) Fault reset \*\*

Instance	Byte	15	14	13	12	11	10	9	8	7	6	5	4	3	2	1	0	Hex.
Output Instance 20	1, 0	0	0	0	0	0	0	0	0	0	0	0	0	0	1	0	0	0x0004
	3, 2	-	-	-	-	-	-	-	-	-	-	-	-	-	-	-	-	-

\* Drive Reference Speed is set up number of rotations by the hexadecimal number.  
For example, when "Frequency reference" is set up to 1800 $\text{min}^{-1}$ :  
1800 = 0x0708 (Hex.)

\*\* Fault reset works only 1 time when 0 -> 1.

### 5.1.3. Instance 21: CIP extended speed control output

#### Instance 21 mapping

Byte	Bit 7	Bit 6	Bit 5	Bit 4	Bit 3	Bit 2	Bit 1	Bit 0
0	-	Net Ref *	Net Ctrl *	-	-	Fault reset	Run reverse	Run forward
1	-							
2	Drive Reference Speed min <sup>-1</sup> (Low byte)							
3	Drive Reference Speed min <sup>-1</sup> (High byte)							

\* Bit 5 and 6 of the instance 21 byte 0 are defined as follows.

Bit 5 (Net Ctrl)..... When "1" is set, bits 0 (Run forward) and 1 (Run reverse) of byte 0 are enabled. When "0" is set, Run/Stop is according to setup of the parameter  $C_{N0d}$ .

Bit 6 (Net Ref)..... When "1" is set, bytes 2 and 3 are enabled. When "0" is set, Drive Reference Speed is according to setup of the parameter  $F_{N0d}$ .

### 5.1.4. Instance 71: CIP extended speed control input

#### Instance 71 mapping

Byte	Bit 7	Bit 6	Bit 5	Bit 4	Bit 3	Bit 2	Bit 1	Bit 0
0	At reference **	Ref from Net **	Ctrl from Net **	Ready	Running Reverse	Running Forward	Warning	Faulted
1	Drive Status ***							
2	Drive Reference Speed min <sup>-1</sup> (Low byte)							
3	Drive Reference Speed min <sup>-1</sup> (High byte)							

\*\* Bit 5, 6, and 7 of the instance 71 byte 0 are defined as follows.

Bit 5 (Ctrl from Net).....When RUN/STOP command from EtherNet/IP™ is enabled, "1" is set.

Bit 6 (Ref from Net).....When frequency command from EtherNet/IP™ is enabled, "1" is set.

Bit 7 (At reference) .....When output frequency becomes the same as frequency command, "1" is set.

\*\*\* Drive Status is same as the Control Supervisor class State attribute (refer to section 4.6).

- 1 (00000001): Startup
- 2 (00000010): Not Ready
- 3 (00000011): Ready
- 4 (00000100): Enabled
- 5 (00000101): Stopping
- 6 (00000110): Fault Stop
- 7 (00000111): Faulted

#### ■ Examples of Instance 21/71

(1) Stop

Instance	Byte	15	14	13	12	11	10	9	8	7	6	5	4	3	2	1	0	Hex.
Output Instance 21	1, 0	0	0	0	0	0	0	0	0	0	0	0	0	0	0	0	0	0x0000
	3, 2	-	-	-	-	-	-	-	-	-	-	-	-	-	-	-	-	-
Input Instance 71	1, 0	0	0	0	0	0	0	1	1	0	0	0	1	0	0	0	0	0x0310
	3, 2	0	0	0	0	0	0	0	0	0	0	0	0	0	0	0	0	0x0000

(2) Forward running 1800min<sup>-1</sup>

Instance	Byte	15	14	13	12	11	10	9	8	7	6	5	4	3	2	1	0	Hex.
Output Instance 21	1, 0	0	0	0	0	0	0	0	0	0	1	1	0	0	0	0	1	0x0061
	3, 2	0	0	0	0	0	1	1	1	0	0	0	0	1	0	0	0	0x0708
Input Instance 71	1, 0	0	0	0	0	0	1	0	0	1	1	1	1	0	1	0	0	0x04F4
	3, 2	0	0	0	0	0	1	1	1	0	0	0	0	1	0	0	0	0x0708

(3) Fault reset \*

Instance	Byte	15	14	13	12	11	10	9	8	7	6	5	4	3	2	1	0	Hex.
Output Instance 21	1, 0	0	0	0	0	0	0	0	0	0	0	0	0	0	1	0	0	0x0004
	3, 2	-	-	-	-	-	-	-	-	-	-	-	-	-	-	-	-	-

\* Fault reset works only 1 time when 0 -> 1.

---

### 5.1.5. Instance 22: CIP speed and torque control output

---

#### Instance 22 mapping

Word Number	Definition
0	CIP basic command word
1	Speed setpoint ( $\text{min}^{-1}$ )
2	Torque setpoint (Nm)

#### Assembly 22 output command

Refer to Assembly 20.

---

### 5.1.6. Instance 72: CIP speed and torque control input

---

#### Assembly 72 mapping

Word Number	Definition
0	CIP basic status word
1	Actual speed ( $\text{min}^{-1}$ )
2	Actual torque (Nm)

#### Assembly 72 input status

Refer to Assembly 70.

---

### 5.1.7. Instance 23: CIP extended speed and torque control output

---

#### Assembly 23 mapping

Word Number	Definition
0	CIP extended command word
1	Speed setpoint ( $\text{min}^{-1}$ )
2	Torque setpoint (Nm)

#### Assembly 23 output command

Refer to Assembly 21.

---

### 5.1.8. Instance 73: CIP extended speed and torque control input

---

#### Assembly 73 mapping

Word Number	Definition
0	CIP extended status word
1	Actual speed ( $\text{min}^{-1}$ )
2	Actual torque (Nm)

#### Assembly 73 input status

Refer to Assembly 71.



### 5.1.9. Instance 100 : Native drive output

#### Instance 100 mapping

Byte	Bit 7	Bit 6	Bit 5	Bit 4	Bit 3	Bit 2	Bit 1	Bit 0
0	DC braking	ACC1/ ACC2	PI off	THR2	Preset Speed4	Preset Speed3	Preset Speed2	Preset Speed1
1	Net Ctrl*	Net Ref *	Reset trip	Emergency stop	Free run (ST)	Run/stop	Forward/ Reverse	Jog
2	Drive Reference Speed Hz (Low byte) **							
3	Drive Reference Speed Hz (High byte) **							

\* Bit 6 and 7 of the instance 100 byte 1 are defined as follows.

Bit 7 (Net Ctrl)..... When "1" is set, all commands of byte 0 and 1 are enabled. When "0" is set, each commands is according to setup of the parameter  $CN0d$ .

Bit 6 (Net Ref)..... When "1" is set, bytes 2 and 3 are enabled. When "0" is set, Drive Reference Speed is according to setup of the parameter  $FN0d$ .

\*\* Drive Reference Speed is set up by 0.01Hz unit and the hexadecimal number.

For example, when "Frequency reference" is set up to 60Hz, since the minimum unit is 0.01Hz,  
 $60 / 0.01 = 6000 = 0x1770$  (Hex.)

### 5.1.10. Instance 150 : Native drive input

#### Instance 150 mapping

Byte	Bit 7	Bit 6	Bit 5	Bit 4	Bit 3	Bit 2	Bit 1	Bit 0
0	DC braking	ACC2	PI	THR 2 (VF2+tH2)	-	ALARM ( $FL9I$ )	EMG	FL
1	-	READY without ST/RUN	READY with ST/ RUN	Emergency stop	Free run (ST)	Run/Stop	Forward / Reverse	Jog
2	Drive Actual Speed Hz (Low byte)							
3	Drive Actual Speed Hz (High byte)							

## ■ Examples of Instance 100/150

### ① Stop

Instance	Byte	15	14	13	12	11	10	9	8	7	6	5	4	3	2	1	0	Hex.
Output Instance 100	1, 0	0	0	0	0	0	0	0	0	0	0	0	0	0	0	0	0	0x0000
	3, 2	-	-	-	-	-	-	-	-	-	-	-	-	-	-	-	-	-
Input Instance 150	1, 0	0	1	0	0	0	0	0	0	0	0	0	0	0	0	0	0	0x4000
	3, 2	0	0	0	0	0	0	0	0	0	0	0	0	0	0	0	0	0x0000

### ② Forward running 60Hz

Instance	Byte	15	14	13	12	11	10	9	8	7	6	5	4	3	2	1	0	Hex.
Output Instance 100	1, 0	1	1	0	0	0	1	0	0	0	0	0	0	0	0	0	0	0xC400
	3, 2	0	0	0	1	0	1	1	1	0	1	1	1	0	0	0	0	0x1770
Input Instance 150	1, 0	0	1	1	0	0	1	0	0	0	0	0	0	0	0	0	0	0x6400
	3, 2	0	0	0	1	0	1	1	1	0	1	1	1	0	0	0	0	0x1770

### ③ Reverse running 60Hz

Instance	Byte	15	14	13	12	11	10	9	8	7	6	5	4	3	2	1	0	Hex.
Output Instance 100	1, 0	1	1	0	0	0	1	1	0	0	0	0	0	0	0	0	0	0xC600
	3, 2	0	0	0	1	0	1	1	1	0	1	1	1	0	0	0	0	0x1770
Input Instance 150	1, 0	0	1	1	0	0	1	1	0	0	0	0	0	0	0	0	0	0x6600
	3, 2	0	0	0	1	0	1	1	1	0	1	1	1	0	0	0	0	0x1770

### ④ Preset speed 1 with forward running ( $f_r$ )

Instance	Byte	15	14	13	12	11	10	9	8	7	6	5	4	3	2	1	0	Hex.
Output Instance 100	1, 0	1	0	0	0	0	1	0	0	0	0	0	0	0	0	0	1	0x8401
	3, 2	-	-	-	-	-	-	-	-	-	-	-	-	-	-	-	-	-
Input Instance 150 ( $f_r$ is set 5Hz.)	1, 0	0	1	1	0	0	1	0	0	0	0	0	0	0	0	0	0	0x6400
	3, 2	0	0	0	0	0	0	0	1	1	1	1	1	0	1	0	0	0x01F4

### ⑤ Fault reset \*

Instance	Byte	15	14	13	12	11	10	9	8	7	6	5	4	3	2	1	0	Hex.
Output Instance 100	1, 0	0	0	1	0	0	0	0	0	0	0	0	0	0	0	0	0	0x2000
	3, 2	-	-	-	-	-	-	-	-	-	-	-	-	-	-	-	-	-

About the other command, refer to section 3.2.4.2.

\* Fault reset works only 1 time when 0 -> 1.

## 5.1.11. Instance 101: Native drive output

### Instance 101 mapping

Byte	Bit 7	Bit 6	Bit 5	Bit 4	Bit 3	Bit 2	Bit 1	Bit 0
0	-	Net Ref*	Net Ctrl*	-	-	Fault reset	Run reverse	Run forward
1	-							
2	Drive Reference Speed $\text{min}^{-1}$ (Low byte)							
3	Drive Reference Speed $\text{min}^{-1}$ (High byte)							
4	Index (Low byte)							
5	Write	Index (High byte)						
6	Data (Low byte)							
7	Data (High byte)							

\* Bit 5 and 6 of the instance 101 byte 0 are defined as follows.

Bit 5 (Net Ctrl)..... When “1” is set, all commands of byte 0 and 1 are enabled. When “0” is set, each commands is according to setup of the parameter  $L\ N\ O\ d$ .

Bit 6 (Net Ref)..... When “1” is set, bytes 2 and 3 are enabled. When “0” is set, Drive Reference Speed is according to setup of the parameter  $F\ N\ O\ d$ .

## 5.1.12. Instance 151 : Native drive input

### Instance 151 mapping

Byte	Bit 7	Bit 6	Bit 5	Bit 4	Bit 3	Bit 2	Bit 1	Bit 0
0	At reference**	Ref from Net**	Ctrl from Net**	Ready	Running Reverse	Running Forward	Warning	Faulted/ tripped
1	Drive Status *							
2	Drive Actual Speed $\text{min}^{-1}$ (Low byte)							
3	Drive Actual Speed $\text{min}^{-1}$ (High byte)							
4	Index (Low byte)							
5	Write	Error	Index (High byte)					
6	Data (Low byte)							
7	Data (High byte)							

\*\* Bit 5, 6, and 7 of the instance 151 byte 0 are defined as follows.

Bit 5 (Ctrl from Net)..... When command from EtherNet/IP™ is enabled, “1” is set.

Bit 6 (Ref from Net)..... When frequency command from EtherNet/IP™ is enabled, “1” is set.

Bit 7 (At reference) ..... When output frequency becomes the same as frequency command, “1” is set.

\* Drive Status is same as the Control Supervisor class State attribute (refer to 4.6).

- 1 (00000001): Startup
- 2 (00000010): Not Ready
- 3 (00000011): Ready
- 4 (00000100): Enabled
- 5 (00000101): Stopping
- 6 (00000110): Fault Stop
- 7 (00000111): Faulted

## ■ Examples of Instance 101/151

Access the inverter parameter is enabled using byte 4 to 6 of this Instance.

Set the communication number of the parameter to byte 4, 5 (Index), and the value to byte 6, 7 (Data).

In case of the monitor parameter "FE\*\*", the value becomes "communication number - 0x7000 (same as bit14, 15 set to 0)".

### ① Read the parameter $Cn0d$ (Command mode selection, communication number is 0003).

Instance	Byte	15	14	13	12	11	10	9	8	7	6	5	4	3	2	1	0	Hex.
Output Instance 101	5, 4	0	0	0	0	0	0	0	0	0	0	0	0	0	0	1	1	0x0003
	7, 6	-	-	-	-	-	-	-	-	-	-	-	-	-	-	-	-	-
Input Instance 151 ( $Cn0d$ is set 0.)	5, 4	0	0	0	0	0	0	0	0	0	0	0	0	0	0	1	1	0x0003
	7, 6	0	0	0	0	0	0	0	0	0	0	0	0	0	0	0	0	0x0000

### ② Read the parameter $F26B$ (Initial value of UP/DOWN frequency).

Instance	Byte	15	14	13	12	11	10	9	8	7	6	5	4	3	2	1	0	Hex.
Output Instance 101	5, 4	0	0	0	0	0	0	1	0	0	1	1	0	1	0	0	0	0x0268
	7, 6	-	-	-	-	-	-	-	-	-	-	-	-	-	-	-	-	-
Input Instance 151 ( $F26B$ is set 60.0Hz.)	5, 4	0	0	0	0	0	0	1	0	0	1	1	0	1	0	0	0	0x0268
	7, 6	0	0	0	1	0	1	1	1	0	1	1	1	0	0	0	0	0x1770

### ③ Read the parameter $FE04$ (Voltage of DC bus).

Instance	Byte	15	14	13	12	11	10	9	8	7	6	5	4	3	2	1	0	Hex.
Output Instance 101	5, 4	0	0	1	1	1	1	1	0	0	0	0	0	0	1	0	0	0x3E04
	7, 6	-	-	-	-	-	-	-	-	-	-	-	-	-	-	-	-	-
Input Instance 151 ( $FE04$ is 94.49%.)	5, 4	0	0	1	1	1	1	1	0	0	0	0	0	0	1	0	0	0x3E04
	7, 6	0	0	1	0	0	1	0	0	1	1	1	0	1	0	0	1	0x24E9

### ④ Write "60 (Hz)" to the parameter $Sr1$ (Preset speed 1, communication number is 0018).

Instance	Byte	15	14	13	12	11	10	9	8	7	6	5	4	3	2	1	0	Hex.
Output Instance 101	5, 4	1	0	0	0	0	0	0	0	0	0	0	1	1	0	0	0	0x8018
	7, 6	0	0	0	1	0	1	1	1	0	1	1	1	0	0	0	0	0x1770
Input Instance 151 (OK)	5, 4	1	0	0	0	0	0	0	0	0	0	0	1	1	0	0	0	0x8018
	7, 6	0	0	0	1	0	1	1	1	0	1	1	1	0	0	0	0	0x1770
Input Instance 151 (NG) (Error code *)	5, 4	1	1	0	0	0	0	0	0	0	0	0	1	1	0	0	0	0xC018
	7, 6	0	0	0	0	0	0	0	0	0	0	0	0	0	0	0	1	0x0001

About byte 0 - 3, refer to section 5.1.3.

\* Refer to following about the error code.

1(00000001):: Data out of range

2(00000010):: Bad address

3(00000011):: Read only

4(00000100):: Stop to modify or permission error

5(00000101):: All other

### 5.1.13. Instance 102: Native drive output

#### Instance 102 mapping

Byte	Bit 7	Bit 6	Bit 5	Bit 4	Bit 3	Bit 2	Bit 1	Bit 0
0								<i>F831</i> Command data (Low byte)
1								<i>F831</i> Command data (High byte)
2								<i>F832</i> Command data (Low byte)
3								<i>F832</i> Command data (High byte)
4								<i>F833</i> Command data (Low byte)
5								<i>F833</i> Command data (High byte)
6								<i>F834</i> Command data (Low byte)
7								<i>F834</i> Command data (High byte)
8								<i>F835</i> Command data (Low byte)
9								<i>F835</i> Command data (High byte)
10								<i>F836</i> Command data (Low byte)
11								<i>F836</i> Command data (High byte)

Fig. 1 Output Instance 102 Layout

Please refer to "3.2.4 Command data (f831-f838), Monitor data (f841-f848)" for the details of parameter *F831* - *F836*.

### 5.1.14. Instance 152: Native drive input

#### Instance 152 mapping

Byte	Bit 7	Bit 6	Bit 5	Bit 4	Bit 3	Bit 2	Bit 1	Bit 0
0								<i>F841</i> Monitor data (Low byte)
1								<i>F841</i> Monitor data (High byte)
2								<i>F842</i> Monitor data (Low byte)
3								<i>F842</i> Monitor data (High byte)
4								<i>F843</i> Monitor data (Low byte)
5								<i>F843</i> Monitor data (High byte)
6								<i>F844</i> Monitor data (Low byte)
7								<i>F844</i> Monitor data (High byte)
8								<i>F845</i> Monitor data (Low byte)
9								<i>F845</i> Monitor data (High byte)
10								<i>F846</i> Monitor data (Low byte)
11								<i>F846</i> Monitor data (High byte)

Fig. 2 Input Instance 152 Layout

Please refer to "3.2.4 Command data (f831-f838), Monitor data (f841-f848)" for the details of parameter *F841* - *F846*.

## 5.1.15. Instance 103: Allen Bradley Drive Profile Output

### Instance 103 mapping

Byte	Bit 7	Bit 6	Bit 5	Bit 4	Bit 3	Bit 2	Bit 1	Bit 0
0	Not used	1= Local control	00 = No command 01 = Forward command 10 = Reverse command 11 = Not used		1= Clear faults	1=Jog*	1=Start	1=Stop
1	Not used	000 = No command 001 = Reference 1 (Preset 1) 010 = Reference 2 (Preset 2) 011 = Reference. 3 (Preset 3) 100 = Reference. 4 (Preset 4) 101 = Reference. 5 (Preset 5) 110 = Reference. 6 (Preset 6) 111 = Reference. 7 (Preset 7)			Not used	Not used	00 = No command 01 = Accel/decel 1 select 10 = Accel/decel 2 select 11 = hold last select	
2	Drive Reference Speed Hz (Low byte)							
3	Drive Reference Speed Hz (High byte)							
4	<i>F831</i> Command data (Low byte)							
5	<i>F831</i> Command data (High byte)							
6	<i>F832</i> Command data (Low byte)							
7	<i>F832</i> Command data (High byte)							
8	<i>F833</i> Command data (Low byte)							
9	<i>F833</i> Command data (High byte)							
10	<i>F834</i> Command data (Low byte)							
11	<i>F834</i> Command data (High byte)							
12	<i>F835</i> Command data (Low byte)							
13	<i>F835</i> Command data (High byte)							
14	<i>F836</i> Command data (Low byte)							
15	<i>F836</i> Command data (High byte)							
16	<i>F837</i> Command data (Low byte)							
17	<i>F837</i> Command data (High byte)							
18	<i>F838</i> Command data (Low byte)							
19	<i>F838</i> Command data (High byte)							

Please refer to "3.2.4 Command data (f831-f838), Monitor data (f841-f848)" for the details of parameter *F831* - *F838*.

\*The drive doesn't stop when the RUN command or JOG command turns off during it operates in the jog mode. The drive stops when the "bit 1: Stop" turned on.

## 5.1.16. Instance 104: Allen Bradley Drive Profile Input

### Instance 104 mapping

Byte	Bit 7	Bit 6	Bit 5	Bit 4	Bit 3	Bit 2	Bit 1	Bit 0
0	1=Fault	1=Alarm	-	-	0 = Forward 1 = Reverse	-	1=Running	1=Ready
1	Setpoint source: 0000 = not used 0001 = Terminal VI/II(AI2) 0010 = Terminal RR(AI3) 0011 = Terminal RX(AI1) 0100 = Keypad 0101 = Serial link (2 wire) 0110 = Serial link (4 wire) 0111 = EtherNet/IP™ card 1000 = Analog1 (option RX2) 1001 = Analog 2 (option VI2) 1010 = TB Up/Down frequency 1011 = Pulse input (option) 1100 = Pulse input (motor CPU) 1101 = not used 1110 = not used 1111 = preset speed (CMOD high priority)				Control source: 000 = Terminals 001 = Key pad 010 = Serial link (2 wire) 011 = Serial link (4 wire) 100 = EtherNet/IP™ card 101 = not used 110 = not used 111 = not used			1=At reference speed
2	Drive Actual Speed Hz (Low byte)							
3	Drive Actual Speed Hz (High byte)							
4	<i>F841</i> Monitor data (Low byte)							
5	<i>F841</i> Monitor data (High byte)							
6	<i>F842</i> Monitor data (Low byte)							
7	<i>F842</i> Monitor data (High byte)							
8	<i>F843</i> Monitor data (Low byte)							
9	<i>F843</i> Monitor data (High byte)							
10	<i>F844</i> Monitor data (Low byte)							
11	<i>F844</i> Monitor data (High byte)							
12	<i>F845</i> Monitor data (Low byte)							
13	<i>F845</i> Monitor data (High byte)							
14	<i>F846</i> Monitor data (Low byte)							
15	<i>F846</i> Monitor data (High byte)							
16	<i>F847</i> Monitor data (Low byte)							
17	<i>F847</i> Monitor data (High byte)							
18	<i>F848</i> Monitor data (Low byte)							
19	<i>F848</i> Monitor data (High byte)							

Please refer to "3.2.4 Command data (f831-f838), Monitor data (f841-f848)" for the details of parameter *F841* - *F848*.

---

## 6. About EDS-file

---

Even if access to each object and assemblies of VF-AS1/PS1 uses a configuration tool and an EDS file, it is possible. The EDS file can be downloaded from homepage in the following address.

[http://www.inverter.co.jp/product/inv/vfas1/ipe/index\\_i.htm](http://www.inverter.co.jp/product/inv/vfas1/ipe/index_i.htm)



---

## 7. Unusual diagnosis

---

The VF-AS1/PS1 is able to install two kind options. The option error message is depended on the position of the option under or panel side.

---

### 7.1. Option error

---

The error message is displayed when there is hardware error, software error or loses of connection of wire.

When an option and a combination of the inverter are bad, it is displayed.

Please use VF-AS1 after V150 or VF-PS1 after V650.

■ Display of trip information

$E - 23$  (Error code : 55) : Add-on option 1 error

(This error is displayed at the time the bottom side option has an error or only one option is installed and has an error.)

$E - 24$  (Error code : 56) : Add-on option 2 error

(This error is displayed at the time the two-units are installed and the upper side option has an error.)

---

### 7.2. Disconnection error of network cable

---

When network trouble occurred by disconnection etc, the inverter does emergency stop with the following indication when the network disconnection detection ( $F850$ ) is set, and it was set in ( $F851=4$ ).

■ Display of trip information

$E r r 8$  (Error code: 27): Communication error.