

**TOSVERT VF-PS1 series****BACnet® option unit Instruction Manual****BCN001Z-2****NOTICE**

1. Make sure that this instruction manual is delivered to the end user of BACnet® Option unit.
2. Read this manual before installing or operating the BACnet® Option unit. Keep it in a safe place for reference.
3. All information contained in this manual is subject to change without notice. Please confirm the latest information on our web site "[www.inverter.co.jp](http://www.inverter.co.jp)".





\*E6581438REV003\*

## Safety precautions

On the inverter and in its instruction manual, important information is contained for preventing injuries to users, damages to assets, and for proper use of the device.

Read the instruction manual attached to the inverter along with this instruction manual to completely understand the safety precautions, the symbols and indications shown below. Please adhere to the contents of these manuals at all times.



### Explanation of markings

Marking	Meaning of marking
 Warning	Indicates that errors in operation may lead to death or serious injury.
 Caution	Indicates that errors in operation may lead to injury (*1) to people or that these errors may cause damage to physical property. (*2)

(\*1) Such things as injury, burns or shock that will not require hospitalization or long periods of outpatient treatment.

(\*2) Physical property damage refers to wide-ranging damage to assets and materials.





### Meanings of symbols



Marking	Meaning of marking
	Indicates prohibition (Do not do it). What is prohibited will be described in or near the symbol in either text or picture form.
	Indicates instruction (What must be done). What the instruction should be followed will be described in or near the symbol in either text or picture form.
	Indicates danger or warning. What is dangerous, or what the warning should be applied to will be described in or near the symbol in either text or picture form.

■ **Limitation of use**



 <b>Safety precaution</b>	
▼	Never use this unit with any device other than TOSVERT VF-PS1 series inverters. Doing so may cause an accident.

■ **Handling in general**



 <b>Warning</b>	
 Never Disassemble	<ul style="list-style-type: none"> <li>▼ Never disassemble, modify or repair the product. Disassembling the product may cause electric shocks, fire or injuries. For repairs, call your sales/repair agency.</li> </ul>
 Prohibited	<ul style="list-style-type: none"> <li>▼ Do not open the front cover on the inverter while the inverter power is on. It may lead to electric shocks.</li> <li>▼ Do not remove this option from VF-PS1 while the power is on. It may lead to electric shocks.</li> <li>▼ Do not put or insert foreign objects such as waste cable, bars or wires into the product. It may lead to electric shocks or fire.</li> <li>▼ Do not splash water over the product, and do not wipe the body with a wet cloth. It may lead to electric shocks or fire.</li> </ul>
 Instructions	<ul style="list-style-type: none"> <li>▼ Turn off the power immediately in case of any abnormalities such as smoke, smell or abnormal noise. Neglect of these conditions may lead to fire. For repairs, call your sales/repair agency.</li> <li>▼ Do not touch the sharp portions (such as leads of parts on the board, the corner of board, or etc.) on this option. It may lead to injuries.</li> </ul>

 <b>Caution</b>	
 Instructions	<ul style="list-style-type: none"> <li>▼ This option is an electrostatic discharge sensitive device. Handle it, where the environment is protected against electrostatic electricity. Otherwise, permanent damage to device will result.</li> </ul>





■ **Transportation and installation**

 <b>Warning</b>	
 Prohibited	<ul style="list-style-type: none"> <li>▼ Do not apply a dropping shock or other physical shocks. Otherwise, damage or malfunction will result.</li> <li>▼ Do not install or operate the inverter if it is damaged or any part of it is missing. Operating a defective inverter may lead to electric shocks or fire. For repairs, call your sales/repair agency.</li> <li>▼ Do not put any flammable material near the product. It may catch fire due to the product sparking in the case of a malfunction.</li> </ul>
 Instructions	<ul style="list-style-type: none"> <li>▼ Use this product under the environmental conditions prescribed in the instruction manual. Usage it under any other conditions may result in malfunction.</li> <li>▼ An emergency stop device must be installed that fits with system specifications (e.g. shut off input power then engage mechanical brake). Operation cannot be stopped immediately by the inverter or this unit alone, thus risking an accident or injuries.</li> <li>▼ Install this option into VF-PS1 and secure it by tightening the terminal board fixing screws to the specified torque. Otherwise, it may cause the product falling, the damage, or malfunctions.</li> <li>▼ Install insulated sheet (attached) under this option. Otherwise, permanent damage to device will result.</li> </ul>



■ **Wiring**

 <b>Caution</b>	
 Instructions	<ul style="list-style-type: none"> <li>▼ Electrical construction work must be done by a qualified expert. Connection of input power by someone who does not have expert knowledge may result in electric shocks or fire.</li> <li>▼ Turn off input power before wiring. Wait at least 15 minutes and make sure that the charge lamp (on the inverter unit) is no longer lit. Otherwise, it may lead to electric shocks.</li> <li>▼ Tighten the screws on the terminal blocks to the specified torque when connecting cables to terminal blocks. Otherwise, it may lead to fire.</li> </ul>

■ **Operations**

 <b>Warning</b>	
 Prohibited	<ul style="list-style-type: none"> <li>▼ Do not pull on the cable and connector. It may cause damage or malfunctions.</li> </ul>
 Instructions	<ul style="list-style-type: none"> <li>▼ Use this option under the environment specified in the instruction manual. Usage under the environment other than them may cause damages or malfunctions or an accident.</li> <li>▼ Use an additional safety device with your inverter or system to prevent a serious accident due to the unit malfunctions. Usage without an additional safety device may cause an accident.</li> </ul>
 <b>Caution</b>	
 Instructions	<ul style="list-style-type: none"> <li>▼ Set up “Communication error trip function (see below)” to stop the inverter when the option unit is deactivated by an unusual event such as an operating error, power outage, failure, etc.                             <ul style="list-style-type: none"> <li>- Network time-out (<i>F832</i>) (See the VF-PS1 BACnet® Communication Function Manual for details.)</li> </ul>                             Deactivated option unit may cause an accident, if the “Communication error trip function” is not properly set up.                         </li> <li>▼ Make sure that the operation signals are STOP before resetting inverter’s fault. The motor may suddenly start and that may result in injuries.</li> </ul>

■ **Disposal**

 <b>Caution</b>	
 Instructions	<ul style="list-style-type: none"> <li>▼ If you dispose off this unit, have it done by a specialist in industrial waste disposal*. Improper disposal may result in explosion of capacitors or produce noxious gases, resulting in injuries. (* ) Persons who specialize in the processing of waste and known as “Industrial Waste Product Collectors and Transporters” or “Industrial Waste Disposal Persons.” If the collection, transport and disposal of industrial waste is done by someone who is not licensed for that job, it is a punishable violation of the law (Laws in regard to cleaning and processing of waste materials).</li> </ul>

■ **Notes on operation**

<b>Notes</b>	
	<ul style="list-style-type: none"> <li>▼ Avoid installing in a place where ambient temperature or/and humidity change sharply.</li> <li>▼ Keep the transmission cable separate from the power cable of the inverter to prevent the inverter from malfunctioning due to electromagnetic noise.</li> <li>▼ Ground of SCR terminal on this option at the grounding terminal separated from those of inverters and motors. It may cause malfunction due to noise.</li> </ul>

# Preface

Thank you for purchasing the “BACnet® option (BCN001Z)” for TOSVERT VF-PS1 inverter. By installing this option unit into the VF-PS1, data communication can be made with a host computer or other device via BACnet® network.

Before using this unit, carefully read this instruction manual in order to completely and correctly utilize excellent performance of this unit. Besides this instruction manual, the “VF-PS1 BACnet® option Function Manual” which includes the contents to install into BACnet® network is prepared. If it is required, please contact with our branch offices, sales offices or web site “www.inverter.co.jp”. (“BACnet® option Function Manual”: E6581440)

After reading this instruction manual, please keep it handy for future reference.

BCN001Z is applicable for VF-PS1 software version V620 or later.

\* BACnet® is a registered trademark of ASHRAE.  
 (ASHRAE : American Society of Heating, Refrigerating and Air-Conditioning Engineers)

- Part numbering

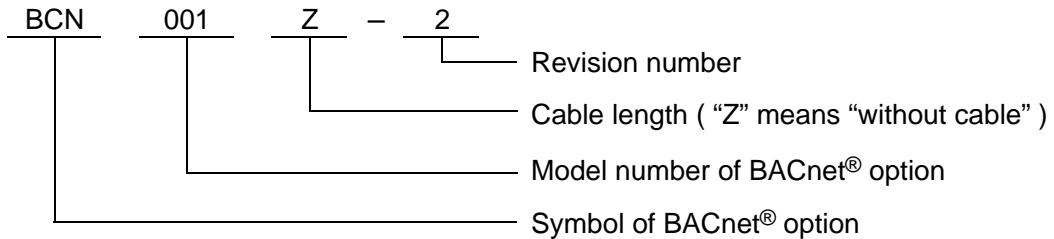

- Accessory check list

BACnet® communication option is shipped together with the following accessories. On opening the packing case, check to see if the following accessories are contained or not.

- (1) BACnet® option unit(BCN001Z)..... 1 unit  
 Connector: MSTB2.5/4-STF-5.08  
 Manufactured by PHOENIX CONTACT

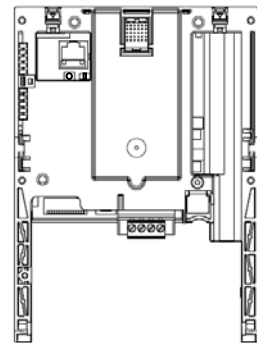

- (2) Instruction manual(This manual).....1 copy  
 E6581438 : Instruction manual for the VF-PS1 BACnet® option

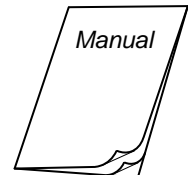

- (3) LED name label.....1 sheet

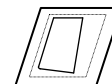

---

# Table of Contents

---

1. Overview .....	6
2. Names and functions.....	6
2.1. Outline.....	6
2.2. BACnet® Connector.....	6
2.3. LED indicator.....	7
3. Installing the BCN001Z .....	8
3.1. Case of installing two options.....	10
3.2. Network cable connection .....	10
3.3. Network configuration.....	11
4. Parameters.....	12
4.1. Communication parameters .....	12
5. Specifications .....	13
6. Warranty.....	13

# 1. Overview

The BACnet (BCN001Z) interface allows the VF-PS1 inverter to be connected into a BACnet MS/TP network. BACnet MS/TP supports a maximum of 32 nodes for one segment. BCN001Z is applicable for VF-PS1 software version V620 or later.

# 2. Names and functions

The drawing below shows names and functions of main parts.

## 2.1. Outline

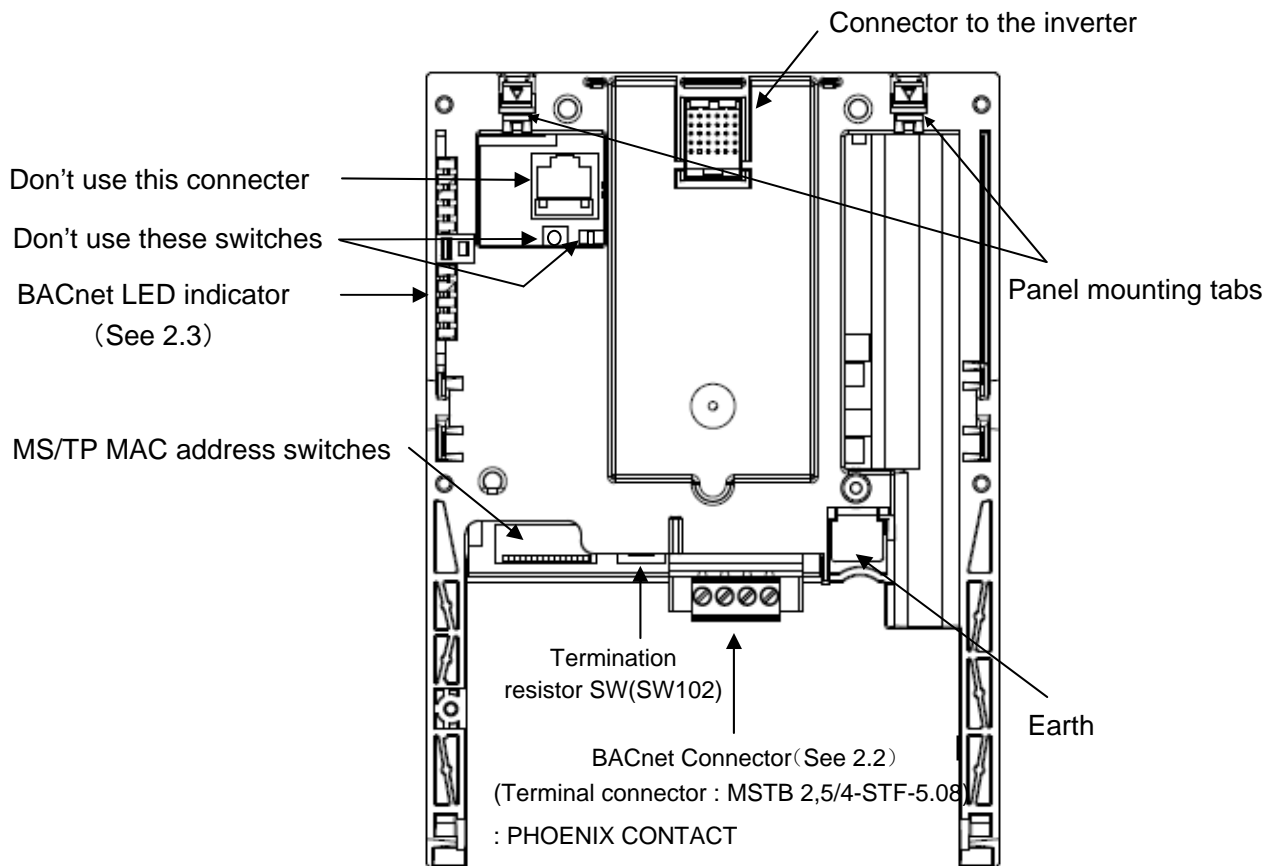

## 2.2. BACnet® Connector

Terminal symbol	Function	Electrical specifications	Internal circuits
B	BACnet® MS/TP communication signal EIA-485	Communication signal (+)	
A		Communication signal (-)	
GND		Signal common	
SCR		Shield terminal. Connect to network ground.	

2.3. LED indicator

The LED shows the present status of the network and error.

Layout of LED

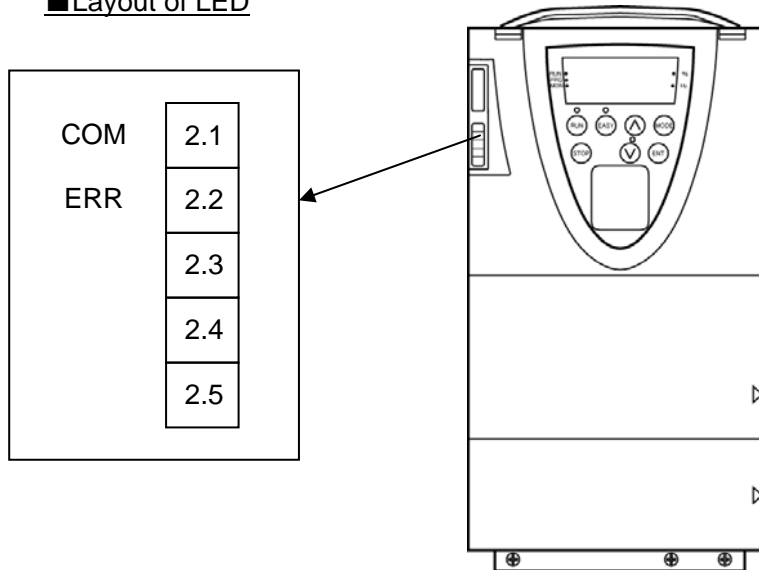

The option has two status LEDs. Those function are below table.

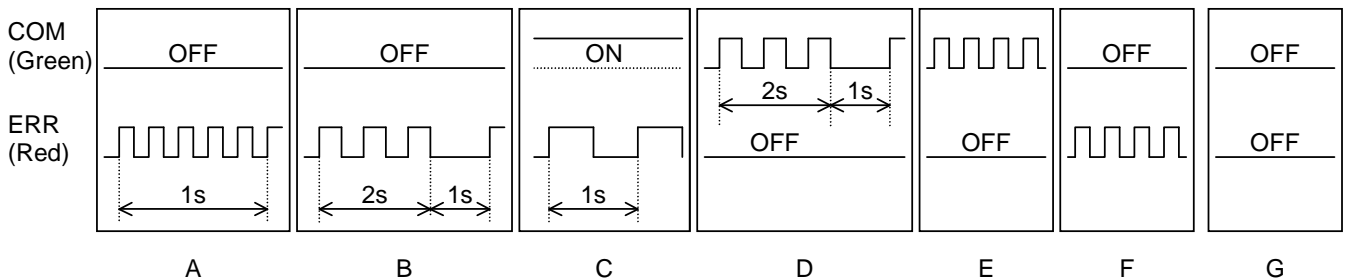

State	LEDs	Comment
A	COM LED: OFF ERR LED: Flashing 5 times in 1 second	BCN001Z failure.
B	COM LED: OFF ERR LED: 3 times in 2 seconds, Off for 1 second	Communication loss was detected. Confirm the network condition and connection of the cable.
C	COM LED: ON ERR LED: OFF 0.5s, ON 0.5s	Invalid configuration was detected. (Note)When inverter occurred in E-23 or E-24, the LED becomes this state.
D	COM LED: 3 times in 2 seconds, Off for 1 second ERR LED: OFF	Waiting for Auto baud rate detection
E	COM LED: Flashing ERR LED: -	Valid message was received for this node
F	COM LED: - ERR LED: Flashing	Invalid message was received (any node)
G	COM LED: OFF ERR LED: OFF	No communication Confirm the network condition and connection of the cable.



### 3. Installing the BCN001Z

Install the BACnet® Option to VF-PS1 as follows.

\* When this option is used together with the IO card option, attach this option to the front panel side.

 <b>Mandatory</b>	Turn off the input power of VF-PS1 and wait for at least 15 minutes and then check that the CHARGE lamp on VF-PS1 is no longer lit.
---	---

- (1) Turn off input power of VF-PS1 and wait for at least 15 minutes and then check that the CHARGE lamp on VF-PS1 is no longer lit.
- (2) Securing the option to the inverter
  - (A) For VFPS1 200V 45kW or less, 400V 75kW or less
    - a) Insert a flat-blade screwdriver in each of the two holes at the upper part of the front panel, release the panel mounting tab by pushing the screwdriver down and remove the front panel cover.
    - b) Install the option in the inverter by fitting the tabs on the lower side the option into the slots at the lower part of the inverter front panel.\*1
    - c) Make sure the option is securely attached to the inverter. Then check whether the plastic bosses on the inverter case have fitted in the holes at the upper and lower parts of the option.
    - d) Insert the tabs at the lower part of the front cover into the slots at the lower part of the inverter to attach the front cover to the inverter.\*1
    - e) Stuck the enclosed "LED name label" in the option LED display part of a front cover.

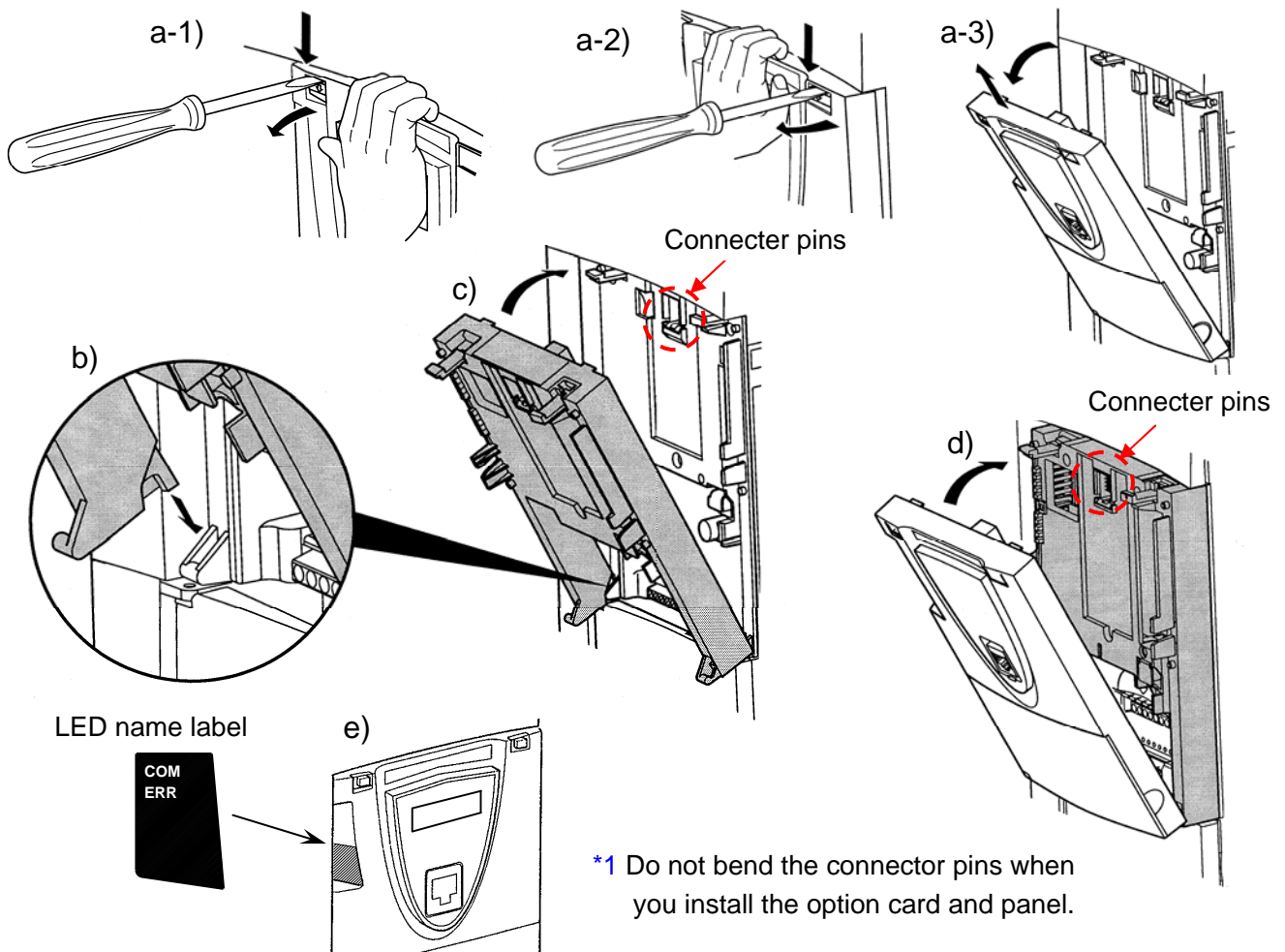

\*1 Do not bend the connector pins when you install the option card and panel.

(B) For VFPS1 200V 55kW or more, 400V 90kW or more

- a) Insert a flat-blade screwdriver in each of the two holes at the upper part of the front panel, release the panel mounting tab by pushing the screwdriver down, and remove the front panel cover.
  - b) Push the hooks pointed by the arrows and remove the standard option case.
  - c) Install the option in the inverter by fitting the tabs on the lower side of the option into the slots at the lower part of the inverter front panel. \*2
  - d) Make sure the option is securely attached to the inverter. Then, check whether the plastic bosses on the inverter case have fitted in the holes at the upper and lower parts of the option.
  - e) Insert the tabs at the lower part of the front cover into the slots at the lower part of the inverter to attach the front cover to the inverter. \*2
  - f) Stuck the enclosed "LED name label" on the option LED display part of a front cover.
- \*2 Do not bend the connector pins when you install the option card and panel.

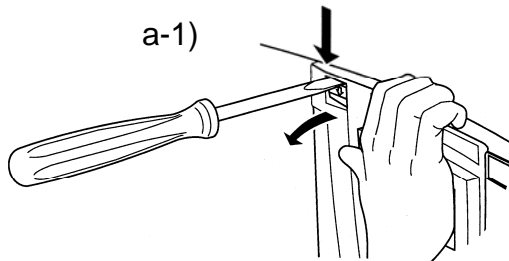

a-2)

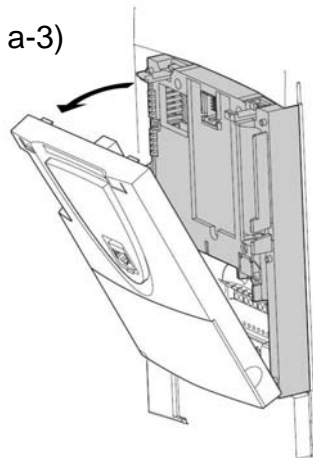

Detach the front cover

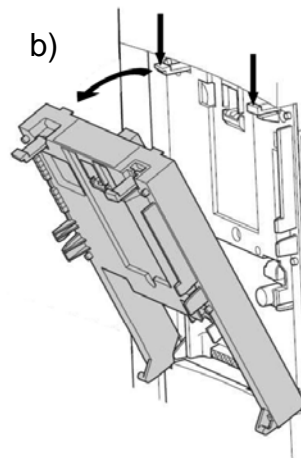

Detach the standard option case

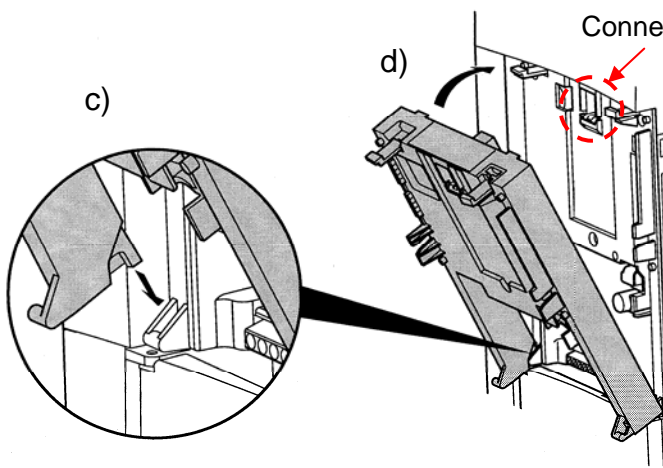

Attach the option

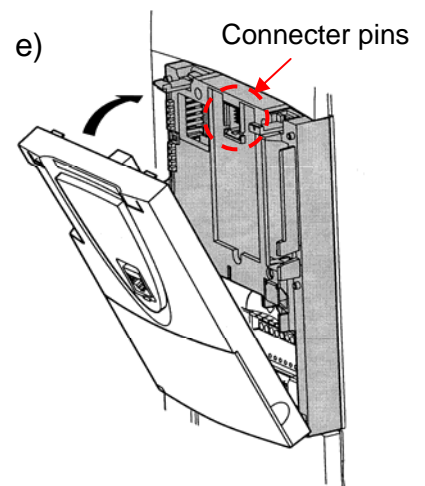

Attach the front cover

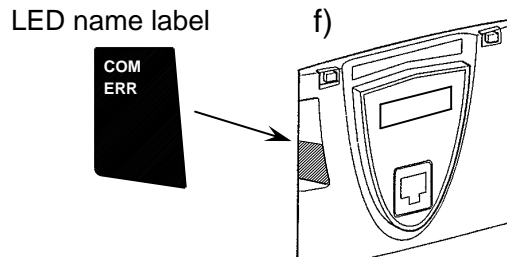

---

### 3.1. Case of installing two options

---

Please install this option (BCN001Z) on the top (panel side) of option when you install two options. Do not install under (inverter body side) the another option.

---

### 3.2. Network cable connection

---

Connect the BACnet® network cable to communication option as follows.

Title	Description
Wire type	Shielded twisted cable
Characteristic impedance	Between 100 and 130 ohm
Distributed impedance between conductors	Less than 100pF per meter
Distributed impedance between conductors and shield	Less than 200pF per meter Foil or braided shield are acceptable.
Length of a segment	1200 meters with AWG18 (0.8mm <sup>2</sup> )

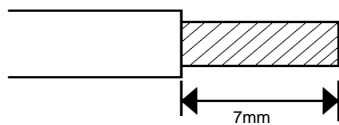

Cable sheath should be peeled off by about 7mm.

For wiring work, use a flat blade screwdriver with a 0.6mm thick and 3.5mm width blade.

Tightening torque for the terminal block is 0.5Nm.

\* Fix a cable so that a communication connector may be not taken the weight of wire.

### 3.3. Network configuration

Make up the network as follows.

- Transmission/reception signals (A, B)

Make up the communication path by connecting all transmission/reception data cables.

- Signal common (GND)

GND is the signal common.

- Grounding the shield of cable (SCR)

Connect the all shield lines of network cable. The shield shall be grounded at only one end to prevent currents from being created.

- Termination resistor

A termination resistance of 120 ohms plus or minus 5% shall be connected at each of the two ends of the segment medium. This option has a termination resistor, so if use, set up the termination resistor SW. (Refer to 2.1 Outline)

At least one set, and no more than two sets, of network bias resistors shall exist for each segment.

But this option has no network bias resistors. This option has local bias resistors only.

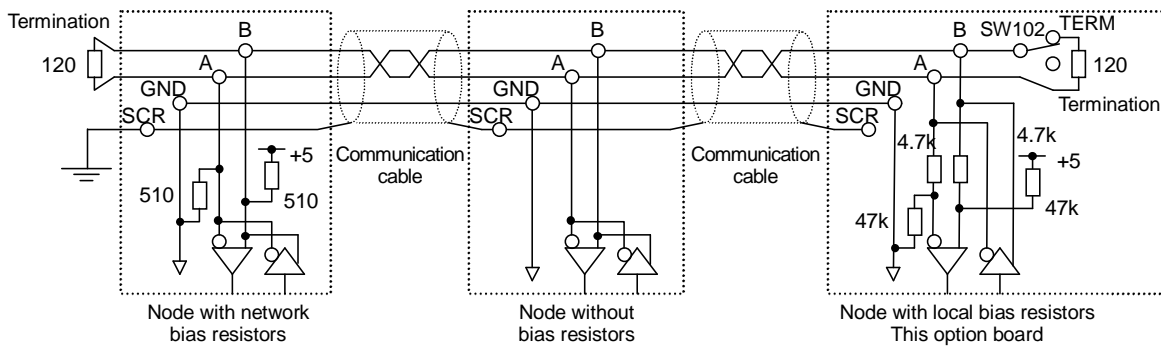

N.B.: Do not connect the SCR terminal to the power ground of inverters or other units.

Keep the network cables 20cm or more separate from the power cables to prevent malfunctioning due to electromagnetic noise.

## 4. Parameters

### 4.1. Communication parameters

Set up the inverter parameters as follows. To update, reset of inverter. If these parameters are not set to correct value, this unit can not work normally.

Title	Function	Description	Factory setting
<i>F831</i>	Network Baudrate *1 *2	0: AUTO adaptive, 1: 9600bps, 2: 19200bps, 3: 38400bps, 4: 76800bps, Over 5 is AUTO adaptive.	0000
<i>F832</i>	Network Time-Out *1 *2	0: No action Unit 0.1 sec, Setting range: 1 - 65535	0000
<i>F833</i>	Instance number *1 *2	Instance No.= <i>F833</i> x 1000 + <i>F834</i>	0000
<i>F834</i>		<i>F834</i> < 1000 Instance No. < 4194304	0000
<i>F835</i>	MaxMaster *1 *2	Setting range: 0 to 127 Over 127 is limited 127.	0000
<i>F836</i>	Maxinfoframe *1 *2	Setting range: 0 to 100 0 same as 1. Over 100 is limited 100.	0000
<i>F851</i>	Operation at communication error by disconnection	0: Inverter stop, communication command, frequency mode open (by <i>C00d</i> , <i>F00d</i> ) 1: None (continued operation) 2: Deceleration stop 3: Coast stop 4: Network error ( <i>E r r B</i> trip) *2 5: Preset speed operation (by <i>F852</i> setting)	0
<i>F852</i>	Preset speed operation selection	0: None 1-15: Preset speed operation (by parameter setting)	0
<i>F853</i>	MAC address*2 (Read Only)	BACnet MS/TP MAC address monitor. (Set DIP switches on board)	-
<i>F856</i>	Number of motor poles for communication *2	1-8: Number of motor pole pairs (It is used to monitor the rotational speed of the motor)	2 (4 poles)
<i>F899</i>	Network option reset setting	0: None 1: Reset option unit and inverter	0
<i>FE66</i>	Add-on option 1 CPU version(Under side option)	Option unit version number. If this monitor value is '123', that means version '1.23'.	-
<i>FE67</i>	Add-on option 2 CPU version(Panel side)		-

\*1: In case of Setting a data via panel, use a hexadecimal number.

ex.) In case of Setting 5.0sec at Timeout parameter, considered unit is 0.1sec, It is need to set a internal value as '50'. Therefore, set '0032' at the panel.

\*2: After change the parameters or to reset *E r r B*, the power needs to be turned off and then turned back on (or set *F899* to *1*). After reset, the parameter changes become effective. *F899* might not be able to be set to *1* by the BACnet communication, and please set *F899* to *1* by Panel.



Please note that inverter keeps driving when the communication is lost if *1* (None) is set to the parameter *F851* (Inverter operation at the communications loss action).

## 5. Specifications

< Environmental specification >

Item	Specification
Model number	BCN001Z
Service environment	Conforms to VF-PS1
Ambient temperature	Conforms to VF-PS1
Storage temperature	-25 to +65°C
Relative humidity	20 to 93% (free from condensation and vapor)
Vibration	5.9m/s <sup>2</sup> (0.6G) or less (10 to 55 Hz) (To be complied with JIS C0040.)
Power supply	24VDC supplied from the inverter

<BCN001Z network specification >

Item	Specification
Data link / Physical layers	Master-Slave / Token Passing (MS/TP)
Node type	Master node
Maximum node	32 nodes per segment
Communication baud rate	9600bps, 19200kbps, 38400kbps, 76800kbps supports auto-baud detection
Bias resistor and termination	Local bias resistors are mounted. Termination resistor (120 ohm) can be select by SW.
Terminal block	Detachable terminal block 4-pole (5.08mm pitch) Manufacturer: PHOENIX CONTACT Type-Form : MSTB 2,5/4-STF-5.08

## 6. Warranty

Any part of BACnet<sup>®</sup> communication option that is proved to be defective will be repaired free of charge under the following conditions:

1. This product will be repaired free of charge, if problem/fault occurs under normal handling within one year of delivery and is caused obviously by a design or manufacturing defect.
2. The warranty applies only to the delivered product.
3. For the following kinds of failure or damage, the repair cost shall be borne by the customer even within the warranty period.
  - i) Failure or damage caused by improper or incorrect use or handling, or unauthorized repair or modification of the inverter.
  - ii) Failure or damage caused by the unit falling or an accident during transportation after the purchase.
  - iii) Failure or damage caused by fire, salty water or wind, corrosive gas, earthquake, storm or flood, lightning, abnormal voltage supply, or other natural disasters.
  - iv) Damage due to the use of BACnet<sup>®</sup> communication option for non-intended purposes.
4. If an additional warranty is provided then those conditions will also apply.