

**TOSVERT VF-PS1 series**

---

**APOGEE® FLN option unit Function Manual**

---

**APG001Z**

---

**NOTICE**

1. Make sure that this instruction manual is delivered to the end user of APOGEE® FLN option unit.
2. Read this manual before installing or operating the APOGEE® FLN option unit. Keep it in a safe place for reference.
3. All information contained in this manual are subject to change without notice. Please confirm the latest information on our web site "[www.inverter.co.jp](http://www.inverter.co.jp)".

## Introduction

Thank you for purchasing the APOGEE® FLN option unit (APG001Z) for VF-PS1 series inverter.

Before using APOGEE® FLN option unit, carefully read this function manual in order to completely and correctly utilize its excellent performance.



After reading this function manual, please keep it handy for future reference.

For details of its general handling, see an instruction manual attached with the option unit.





- TOSVERT VF-PS1 Instruction Manual .....E6581386
- APG001Z Instruction Manual .....E6581541

\* APOGEE® FLN is a registered trademark of Siemens Building Technologies, Inc.

### ■ Handling in general

 <b>Warning</b>	
 Prohibited	▼ Do not connect or disconnect a network cable while the Inverter power is on. It may lead to electric shocks or fire.
 Mandatory	▼ See the instruction manual attached with the option unit for cautions the handling. Otherwise, it may lead to electric shocks, fire, injuries or damage to product.

### ■ Network control

 <b>Warning</b>	
 Prohibited	▼ Do not send the value out of the valid range to network variables. Otherwise, the motor may suddenly start/stop and that may result in injuries.
 Mandatory	▼ Use an additional safety device with your system to prevent a serious accident due to the network malfunctions. Usage without an additional safety device may cause an accident.
 <b>Caution</b>	
 Mandatory	▼ Set up “Communication error trip function (see below)” to stop the Inverter when the option unit is deactivated by an unusual event such as tripping, an operating error, power outage, failure, etc. <ul style="list-style-type: none"> <li>- Network Time-Out, Inverter operation at disconnection, Preset speed operation selection (<i>F832</i>, <i>F851</i> and <i>F852</i>, see the Inverter instruction manual for details)</li> </ul> Deactivated option unit may cause an accident, if the “Communication error trip function” is not properly set up. ▼ Make sure that the operation signals are STOP before resetting Inverter's fault. The motor may suddenly start and that may result in injuries.

### ■ Notes on operation

<b>Notes</b>	
	▼ When the control power is shut off by the instantaneous power failure, communication will be unavailable for a while. ▼ The Life of EEPROM is approximately 100000 times. Avoid writing a command more than 100000 times to the same parameter of the Inverter and the communication board.

---

# Table of Contents

---

<b>1. OVERVIEW</b> .....	<b>3</b>
<b>2. NAMES AND FUNCTIONS</b> .....	<b>3</b>
2.1. Outline .....	3
2.2. APOGEE® FLN Connector .....	3
2.3. LED indicator .....	4
<b>3. VF-PS1 PARAMETERS</b> .....	<b>5</b>
3.1. Communication parameters .....	5
3.2. Network Baudrate ( <i>F 8 3 1</i> ) .....	6
3.3. Network error detection ( <i>F 8 3 2, F 8 5 1, F 8 5 2</i> ) .....	6
3.4. Reset to factory defaults ( <i>F 8 3 3</i> ) .....	6
3.5. Station address ( <i>F 8 3 4</i> ) .....	6
<b>4. APG001Z POINT SUMMARIES</b> .....	<b>7</b>
4.1. Logical Analog Input (LAI) Summary .....	9
4.1.1. LAI Point Descriptions .....	10
4.2. Logical Analog Output (LAO) Summary .....	11
4.2.1. LAO Point Descriptions .....	12
4.3. Logical Digital Input (LDI) Summary .....	13
4.3.1. LDI Point Descriptions .....	14
4.4. Logical Digital Output (LDO) Summary .....	15
4.4.1. LDO Point Descriptions .....	16
4.5. FLN P1 Error Codes .....	18
<b>5. MAILBOX FUNCTION POINTS</b> .....	<b>19</b>
5.1. Parameter data .....	20
<b>6. FRAME COUNTER MONITOR</b> .....	<b>21</b>
<b>7. VF-PS1 ALARM CODE</b> .....	<b>22</b>
<b>8. VF-PS1 FAULT CODE</b> .....	<b>23</b>
<b>9. UNUSUAL DIAGNOSIS</b> .....	<b>24</b>
9.1. Option error .....	24
9.2. Disconnection error of network cable .....	24
<b>10. COMMAND &amp; SETPOINT SELECTION (LOCAL/REMOTE)</b> .....	<b>25</b>
<b>11. SPECIFICATIONS</b> .....	<b>27</b>

## 1. Overview

The APOGEE® FLN interface (APG001Z) allows the VF-PS1 inverter to be connected into a APOGEE® FLN network.

## 2. Names and functions

The drawing below shows names and functions of main parts.

### 2.1. Outline

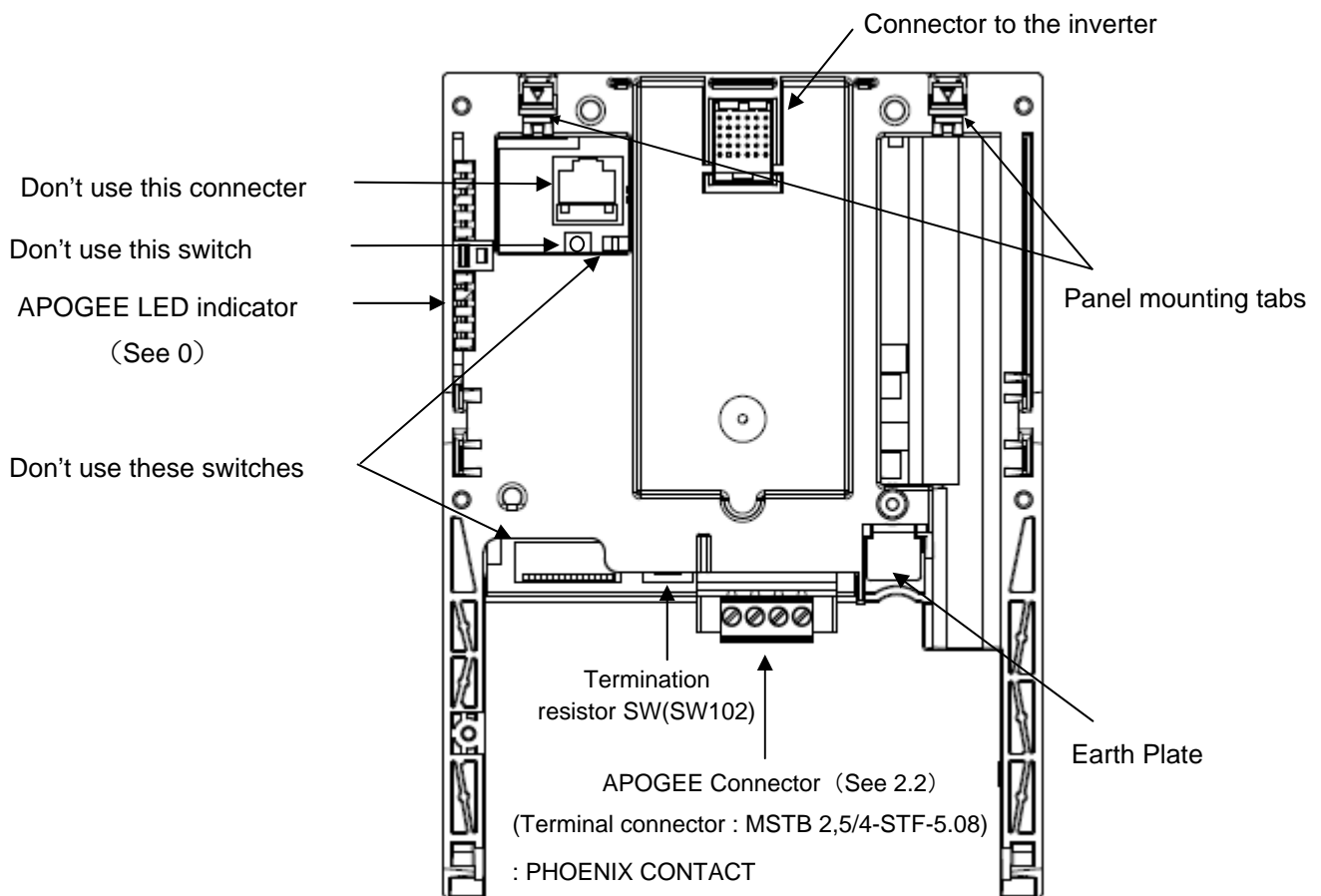

### 2.2. APOGEE® FLN Connector

Terminal symbol	Function	Electrical specifications	Internal circuits
B	APOGEE® FLN communication signal EIA-485	Communication signal (+)	
A		Communication signal (-)	
GND		Signal common	
SCR		Shield terminal.	

## 2.3. LED indicator

The LED shows the present status of the network and error.

### Layout of LED

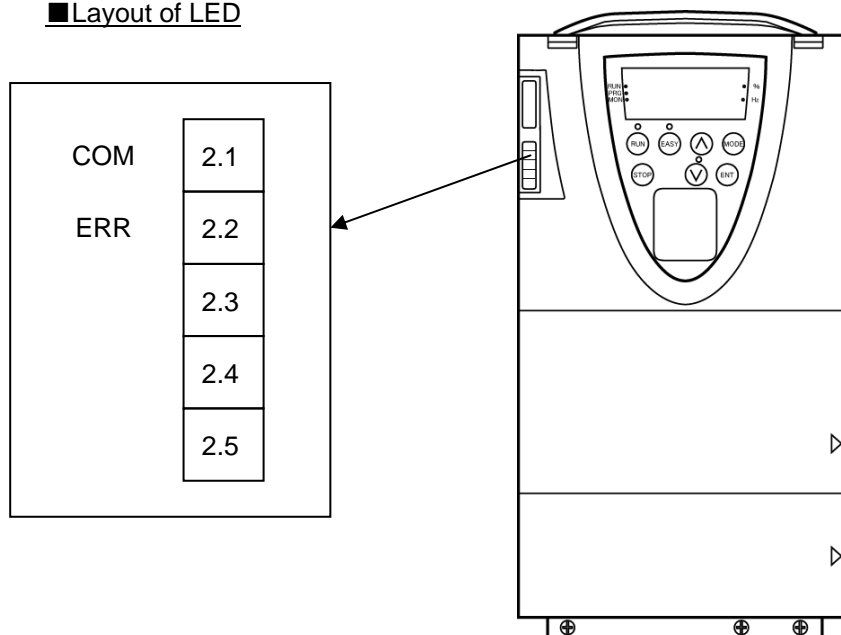

The option has two LEDs. Those function are below table.

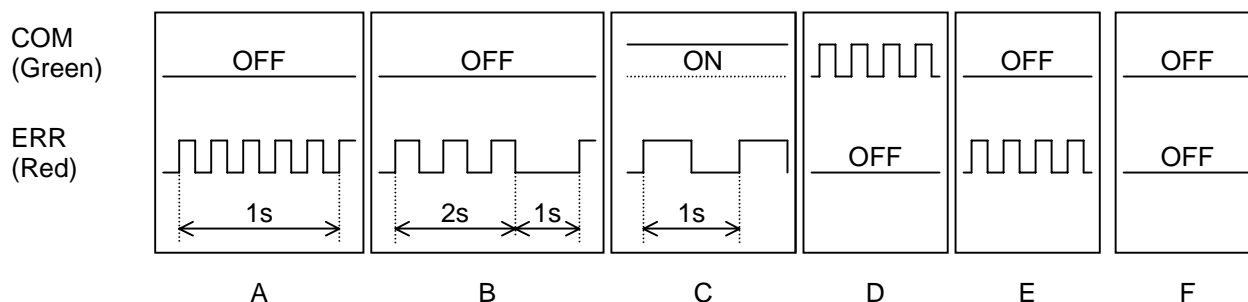

State	LEDs	Comment
A	COM LED: OFF ERR LED: Flashing 5 times in 1 second	APG001Z failure.
B	COM LED: OFF ERR LED: 3 times in 2 seconds, Off for 1 second	Communication loss was detected. Confirm the network condition and connection of the cable.
C	COM LED: ON ERR LED: OFF 0.5s, ON 0.5s	Invalid configuration was detected. (Note)When inverter occurred in $E - 23$ or $E - 24$ , the LED becomes this state.
D	COM LED: Flashing ERR LED: -	Valid message was received for this node
E	COM LED: - ERR LED: Flashing	Invalid message was received (any node)
F	COM LED: OFF ERR LED: OFF	No communication Confirm the network condition and connection of the cable.

## 3. VF-PS1 Parameters

### 3.1. Communication parameters

Set up the inverter parameters as follows. To update, reset of inverter. If these parameters are not set to correct value, this unit can not work normally.

Title	Communication No.	Function	Description	Factory setting
<i>F831</i>	0831	Network Baudrate (*1)	0: 9600bps,1: 4800bps,2: 9600bps 3: 19200bps,4: 38400bps, 5: 57600bps,6: 76800bps Over 7 is 9600bps.	0000
<i>F832</i>	0832	Network Time-Out (*1)	0: No action Unit 0.1 sec, Setting range: 1 – 1000 Over 1000 is 100.0s.	0000
<i>F833</i>	0833	Factory setting (*1)	Except ACh : Reset to factory setting ACh : Finished with reset to factory setting	0000 (ACh)
<i>F834</i>	0834	Station address	1-99 The range outside is converted into 99	0000
<i>F851</i>	0851	Operation at communication error by disconnection	0: Inverter stop, communication command, frequency mode open (by <i>CNOd</i> , <i>FNOd</i> ) 1: None (continued operation) 2: Deceleration stop 3: Coast stop 4: Network error ( <i>ErrB</i> trip) 5: Preset speed operation (by <i>F852</i> setting)	0
<i>F852</i>	0852	Preset speed operation selection	0:None 1~15:Preset speed operation (by parameter setting)	0
<i>F853</i>	0853	Communication option station address monitor (Read Only)	Real station address monitor If a value of <i>F834</i> is out of a range, the value of <i>F853</i> becomes 99.	—
<i>F899</i>	0899	Network option reset setting	0:None 1:Reset option circuit board and inverter	0
—	FE66	Add-on option 1 CPU version(Under side option)	High byte is version. Low byte is revision. For example, When version number 1, and revision number 2 is, panel indication becomes with 1.02. The version of the option with it has equipped can be checked by using the function of <i>F710</i> to <i>F718</i> (standard monitor display selection).	—
—	FE67	Add-on option 2 CPU version(Panel side)	*For details, refer to the inverter instruction manual.	—

\* When *FNOd* or *CNOd* is set to “Communication option input”, VF-PS1 drives without FLN LOC REF (LDO point #69) or FLN LOC CTL (LDO point #68) at each Objects.

(\*1): This parameter is effective by reset. Please reset (power supply reset or *F899*= 1) after changing a set point.

---

### 3.2. Network Baudrate (F831)

---

Set the network baud rate to F831. Set the same baud rate data in the network.

---

### 3.3. Network error detection (F832,F851,F852)

---

Set the network communication loss action time to F832. The network loss action function starts from receiving the properly frame message. The action of the network communication loss is set by F851.

When setting of F851 is set other than 4 when it was detected, 't' alarm occurs with the inverter.

In addition, in the case of F851=5, it runs at designated frequency in "Preset speed operation selection(F852)".

---

### 3.4. Reset to factory defaults (F833)

---

This parameter(F833) is connected to point number one hundred(Pno.100).

Reset is possible to factory setting in offline by using this parameter.

Point number one hundred is called the *factory flag*.

*factory flag* is used to determine if the initial values need to be "initialized." If the *factory flag* does not equal ACH, the initial value for each subpoint will be set equal to the default value. Then, the *factory flag* is set to ACH,

---

### 3.5. Station address (F834)

---

This parameter is connected to Pno.1.

Address setting is possible in the offline state which is not connected to the network.

The station address can be set between 1 and 99

When it was set to out of range, APG001Z converts it into 99, and the value of Pno.1 and F834 becomes 99.

The station address must be unique and not match any other device on the network.

## 4. APG001Z Point Summaries

This database features 85 logical points: 24 Logical Analog Inputs (LAI), 19 Logical Analog Outputs (LAO), 24 Logical Digital Inputs (LDI) and 18 Logical Digital Outputs (LDO). These points configure, control or monitor the operation of the Drive.

(Note)"PointName" in the parenthesis is a reservation definition.

The point of the reservation definition does not work.



Table 1 Point Summary

Point Number	Point Type	Point Name	Factory Default	Eng. Units	Slope	Intercept	ON Text	OFF Test
<b>01</b>	<b>LAO</b>	<b>CTLR ADDRESS</b>	<b>99</b>	-	<b>1</b>	<b>0</b>	-	-
<b>02</b>	<b>LAO</b>	<b>APPLICATION</b>	<b>2739</b>	-	<b>1</b>	<b>0</b>	-	-
03	LAI	FREQ OUTPUT	0	HZ	0.1	0	-	-
04	LAI	PCT OUTPUT	0	PCT	0.1	0	-	-
05	LAI	SPEED	0	RPM	1	0	-	-
06	LAI	CURRENT	0	A	0.1	0	-	-
07	LAI	TORQUE	2000	PCT	0.1	-200	-	-
08	LAI	POWER	0	KW	0.1	0	-	-
09	LAI	DRIVE TEMP	0	PCT	0.1	0	-	-
10	LAI	DRIVE KWH	0	kWH	1	0	-	-
11	LAI	DRIVE MWH	0	MWH	1	0	-	-
12	LAI	RUN TIME	0	H	1	0	-	-
13	LAI	DC BUS VOLT	0	V	1	0	-	-
14	LAI	OUTPUT VOLT	0	V	1	0	-	-
15	LAI	PRC PID FBCK	0	PCT	0.1	0	-	-
16	LAI	(PRC PID DEV)	0	PCT	0.1	N/A	N/A	N/A
17	LAI	(MOTOR TEMP)	0	PCT	0.1	N/A	N/A	N/A
18	N/A	N/A	N/A	N/A	N/A	N/A	N/A	N/A
19	N/A	N/A	N/A	N/A	N/A	N/A	N/A	N/A
<b>20</b>	<b>LAO</b>	<b>OVRD TIME</b>	<b>1</b>	<b>H</b>	<b>1</b>	<b>0</b>	-	-
21	LDI	FWD.REV	FWD	-	1	0	REV	FWD
22	LDO	CMD FWD.REV	FWD	-	1	0	REV	FWD
23	LDI	STOP.RUN	STOP	-	1	0	RUN	STOP
24	LDO	CMD STP.STRT	STOP	-	1	0	RUN	STOP
25	LDI	EXT1.2 ACT	EXT1	-	1	0	EXT2	EXT1
26	LDO	EXT1.2 CMD	EXT1	-	1	0	EXT2	EXT1
27	LDI	DRIVE READY	NOTRD Y	-	1	0	READY	NOTRDY
28	LDI	AT SETPOINT	NO	-	1	0	YES	NO
<b>29</b>	<b>LDO</b>	<b>DAY.NIGHT</b>	<b>DAY</b>	-	<b>1</b>	<b>0</b>	<b>NIGHT</b>	<b>DAY</b>
30	LAO	CURRENT LIM	0	A	0.1	0	-	-
31	LAO	ACCEL TIME 1(Note1)	300	S	0.1	0	-	-
32	LAO	DECEL TIME 1(Note1)	300	S	0.1	0	-	-
33	LDI	HANDAUTO ACT	AUTO	-	1	0	HAND	AUTO
34	N/A	N/A	N/A	N/A	N/A	N/A	N/A	N/A
35	N/A	N/A	N/A	N/A	N/A	N/A	N/A	N/A
36	LDI	FLN LOC ACT	AUTO	-	1	0	FLN	AUTO
37	LDI	CTL SRC	NO	-	1	0	YES	NO
38	LDI	FLN REF1 SRC	NO	-	1	0	YES	NO
39	LDI	FLN REF2 SRC	NO	-	1	0	YES	NO
40	LDO	DO 1 COMMAND	OFF	-	1	0	ON	OFF
41	LDO	DO 2 COMMAND	OFF	-	1	0	ON	OFF
42	LDO	DO 3 COMMAND	OFF	-	1	0	ON	OFF
43	LDO	DO 4 COMMAND	OFF	-	1	0	ON	OFF
44	LDO	DO 5 COMMAND	OFF	-	1	0	ON	OFF
45	LDO	DO 6 COMMAND	OFF	-	1	0	ON	OFF



Point Number	Point Type	Point Name	Factory Default	Eng. Units	Slope	Intercept	ON Text	OFF Test
46	LAO	AO 1 COMMAND	0	PCT	0.1	0	-	-
47	LAO	AO 2 COMMAND	0	PCT	0.1	0	-	-
48	LDO	(RST RUN TIME)	NO	-	1	0	RESET	NO
49	LDO	RESET KWH	NO	-	1	0	RESET	NO
50	LAO	PRC PID GAIN	10	PCT	0.1	0	-	-
51	LAO	PRC PID ITIM	500	S	0.1	0	-	-
52	LAO	PRC PID DTIM	0	S	0.1	0	-	-
53	LAO	(PRC PID DFIL)	10	S	0.1	0	-	-
54	N/A	N/A	N/A	N/A	N/A	N/A	N/A	N/A
55	N/A	N/A	N/A	N/A	N/A	N/A	N/A	N/A
56	N/A	N/A	N/A	N/A	N/A	N/A	N/A	N/A
57	N/A	N/A	N/A	N/A	N/A	N/A	N/A	N/A
58	N/A	N/A	N/A	N/A	N/A	N/A	N/A	N/A
59	LDO	LOCK PANEL	UNLOCK	-	1	0	LOCK	UNLOCK
60	LAO	INPUT REF1	0	PCT	0.1	0	-	-
61	LAO	INPUT REF2	0	PCT	0.1	0	-	-
62	N/A	N/A	N/A	N/A	N/A	N/A	N/A	N/A
63	N/A	N/A	N/A	N/A	N/A	N/A	N/A	N/A
64	N/A	N/A	N/A	N/A	N/A	N/A	N/A	N/A
65	N/A	N/A	N/A	N/A	N/A	N/A	N/A	N/A
66	LAO	SPD OUT MIN	0	PCT	0.1	0	-	-
67	LAO	SPD OUT MAX	1000	PCT	0.1	0	-	-
68	LDO	FLN LOC CTL	AUTO	-	1	0	FLN	AUTO
69	LDO	FLN LOC REF	AUTO	-	1	0	FLN	AUTO
70	LDI	DI 1 ACTUAL	OFF	-	1	0	ON	OFF
71	LDI	DI 2 ACTUAL	OFF	-	1	0	ON	OFF
72	LDI	(DI 3 ACTUAL)	OFF	-	1	0	ON	OFF
73	LDI	DI 4 ACTUAL	OFF	-	1	0	ON	OFF
74	LDI	DI 5 ACTUAL	OFF	-	1	0	ON	OFF
75	LDI	DI 6 ACTUAL	OFF	-	1	0	ON	OFF
76	LDI	DO 1 ACTUAL	OFF	-	1	0	ON	OFF
77	LDI	DO 2 ACTUAL	OFF	-	1	0	ON	OFF
78	LDI	DO 3 ACTUAL	OFF	-	1	0	ON	OFF
79	LDI	DO 4 ACTUAL	OFF	-	1	0	ON	OFF
80	LDI	DO 5 ACTUAL	OFF	-	1	0	ON	OFF
81	LDI	DO 6 ACTUAL	OFF	-	1	0	ON	OFF
82	LAI	AI 1 ACTUAL	0	PCT	0.1	0	-	-
83	LAI	AI 2 ACTUAL	0	PCT	0.1	0	-	-
84	LAI	AO 1 ACTUAL	0	PCT	0.1	0	-	-
85	LAI	AO 2 ACTUAL	0	PCT	0.1	0	-	-
86	LDI	OK.ALARM	OK	-	1	0	ALARM	OK
87	N/A	N/A	N/A	N/A	N/A	N/A	N/A	N/A
88	LAI	ALARM WORD 1	0	-	1	0	-	-
89	LAI	ALARM WORD 2	0	-	1	0	-	-
90	LAI	LAST FAULT	0	-	1	0	-	-
91	LAI	PREV FAULT 1	0	-	1	0	-	-
92	LAI	PREV FAULT 2	0	-	1	0	-	-
93	LDI	OK.FAULT	OK	-	1	0	FAULT	OK
94	LDO	RESET FAULT	NO	-	1	0	RESET	NO
95	LAO	MBOX PARAM	0	-	1	0	-	-
96	LAO	MBOX DATA	0	-	1	0	-	-
97	LDO	MBOX READ	DONE	-	1	0	READ	DONE
98	LDO	MBOX WRITE	DONE	-	1	0	WRITE	DONE
<b>99</b>	<b>LAO</b>	<b>ERROR STATUS</b>	<b>0</b>	<b>-</b>	<b>1</b>	<b>0</b>	<b>-</b>	<b>-</b>

(Note1) Be careful in use of point number 31 and 32 about the following.

 <b>Warning</b>	
 Mandatory	<p>▼ <b>This option designs the unit of "Acceleration/deceleration time" in 0.1sec. Please do not set "10:Acceleration/deceleration time setting 0.01 sec.~600.00sec". in Factory default setting (ㄷ ㄱ P=10).</b></p> <p>A unit of "Acceleration/deceleration time setting" is changed instantly when set ㄷ ㄱ P=10.</p> <p>When this option is connected to the inverter, the data unit of Point Number 31 and 32 is changed to "0.01 second".</p> <p>It is possible that it leads to the unexpected machinery operation, and death, a serious wound or equipment parts are damaged.</p>

## 4.1. Logical Analog Input (LAI) Summary

Logical Analog Input (LAI) points are used for monitoring drive status items such as output frequency, current and voltage. The APG001Z supports 24 different logical analog input points. Change of value (COV) of LAI points can be enabled (LAI points are capable of being characterized). LAI points will respond to write point and memorize point commands, but will not change their actual values or indicate override active.

(Note)"PointName" in the parenthesis is a reservation definition.

The point of the reservation definition does not work.

Table 2 Logical Analog Input (LAI) Summary

Point Number	Point Name	Factory Default	Eng. Units	Slope	Intercept	Min	Max
03	FREQ OUTPUT	0	HZ	0.1	0	0	32767
04	PCT OUTPUT	0	PCT	0.1	0	0	32767
05	SPEED	0	RPM	1	0	0	32767
06	CURRENT	0	A	0.1	0	0	32767
07	TORQUE	2000	PCT	0.1	-200	0	32767
08	POWER	0	KW	0.1	0	0	32767
09	DRIVE TEMP	0	PCT	0.1	0	0	32767
10	DRIVE KWH	0	kWH	1	0	0	32767
11	DRIVE MWH	0	MWH	1	0	0	32767
12	RUN TIME	0	H	1	0	0	32767
13	DC BUS VOLT	0	V	1	0	0	32767
14	OUTPUT VOLT	0	V	1	0	0	32767
15	PRC PID FBCK	0	PCT	0.1	0	0	32767
16	(PRC PID DEV)	0	PCT	0.1	N/A	0	32767
17	(MOTOR TEMP)	0	PCT	0.1	N/A	0	32767
82	AI 1 ACTUAL	0	PCT	0.1	0	0	32767
83	AI 2 ACTUAL	0	PCT	0.1	0	0	32767
84	AO 1 ACTUAL	0	PCT	0.1	0	0	32767
85	AO 2 ACTUAL	0	PCT	0.1	0	0	32767
88	ALARM WORD 1*	0	-	1	0	0	32767
89	ALARM WORD 2*	0	-	1	0	0	32767
90	LAST FAULT**	0	-	1	0	0	32767
91	PREV FAULT 1**	0	-	1	0	0	32767
92	PREV FAULT 2**	0	-	1	0	0	32767

\* Refer to section 7 about the alarm code of VF-PS1.

\*\* Refer to section 8 about the trip code of VF-PS1.

## 4.1.1. LAI Point Descriptions

Table 3 Logical Analog Input (LAI) Point Descriptions

Point Number	Point Name	Description
03	FREQ OUTPUT	The output frequency applied to the motor, in Hertz.
04	PCT OUTPUT	The ratio of output frequency or speed to the corresponding $\omega$ (base frequency).
05	SPEED	The calculated speed of the motor, in RPM.
06	CURRENT	The measured output current.
07	TORQUE	The calculated output torque of the motor as a percentage of nominal torque.
08	POWER	The measured output power in kW.
09	DRIVE TEMP	The calculated thermal state of the drive.
10	DRIVE KWH	The drive's cumulative power consumption in kilowatt-hours. This value may be reset by commanding FLN point 49, RESET KWH.
11	DRIVE MWH	The drive's cumulative power consumption in megawatt-hours. This value may be reset by commanding FLN point 49, RESET KWH.
12	RUN TIME	The drive's cumulative run time in hours.
13	DC BUS VOLT	The DC bus voltage level of the drive.
14	OUTPUT VOLT	The AC output voltage applied to the motor.
15	PRC PID FBCK	The ratio of PID feedback signal to the corresponding $\omega$ (base frequency).
16	(PRC PID DEV)	Reserved (does not work)
17	(MOTOR TEMP)	Reserved (does not work)
82	AI 1 ACTUAL	Indicates the input level of <b>RR/S4</b> terminal.
83	AI 2 ACTUAL	Indicates the input level of <b>V/II</b> terminal.
84	AO 1 ACTUAL	Indicates the output level of <b>FM</b> terminal.
85	AO 2 ACTUAL	Indicates the output level of <b>AM</b> terminal.
88	ALARM WORD 1 *	This point is a bit-field indicating active alarms in the drive.
89	ALARM WORD 2 *	This point is a bit-field indicating active alarms in the drive.
90	LAST FAULT **	This point is first in the drive's fault log and indicates the most recent fault declared.
91	PREV FAULT 1 **	This point is second in the drive's fault log and indicates the previous fault declared.
92	PREV FAULT 2 **	This point is last in the drive's fault log and indicates the oldest fault in the log.

\* About the ALARM code of VF-PS1, refer to section 7.

\*\* About the FAULT code of VF-PS1, refer to section 8.

## 4.2. Logical Analog Output (LAO) Summary

Logical Analog Output (LAO) points are used for setting and monitoring control points such as the drive's frequency command and configuration parameters.

The APG001Z supports 19 different logical analog output points (15 of them are for the VF-PS1's parameters and commands, while other 4 special points are reserved for maintaining compliance). The values of all logical analog output points can be modified by write point or memorize point commands. Release commands will not cause the logical analog output points to automatically return to their pre-override values. LAO points do not support COV.

Table 4 Logical Analog Output (LAO) Summary



Point Number	Point Name	Factory Default	Eng. Units	Slope	Intercept	Min	Max
<b>01</b>	<b>CTLR ADDRESS</b>	<b>99</b>	-	<b>1</b>	<b>0</b>	<b>0</b>	<b>99</b>
<b>02</b>	<b>APPLICATION</b>	<b>2739</b>	-	<b>1</b>	<b>0</b>	<b>0</b>	<b>32767</b>
<b>20</b>	<b>OVRD TIME</b>	<b>1</b>	<b>H</b>	<b>1</b>	<b>0</b>	<b>0</b>	<b>255</b>
30	CURRENT LIM ***	0	A	0.1	0	0	32767
31	ACCEL TIME 1 (Note1)	300	S	0.1	0	0	32767
32	DECEL TIME 1 (Note1)	300	S	0.1	0	0	32767
46	AO 1 COMMAND	0	PCT	0.1	0	0	32767
47	AO 2 COMMAND	0	PCT	0.1	0	0	32767
50	PRC PID GAIN	10	PCT	0.1	0	0	32767
51	PRC PID ITIM ***	500	S	0.1	0	0	32767
52	PRC PID DTIM	0	S	0.1	0	0	255
53	(PRC PID DFIL)	10	S	0.1	0	0	255
60	INPUT REF1 *	0	PCT	0.1	0	0	32767
61	INPUT REF2 *	0	PCT	0.1	0	0	32767
66	SPD OUT MIN	0	PCT	0.1	0	0	32767
67	SPD OUT MAX	1000	PCT	0.1	0	0	32767
95	MBOX PARAM **	-	-	1	0	0	32767
96	MBOX DATA **	-	-	1	0	0	32767
<b>99</b>	<b>ERROR STATUS</b>	-	-	<b>1</b>	<b>0</b>	<b>0</b>	<b>255</b>

\*100%= $\omega_L$  (Base frequency),  $F_H$  (Maximum frequency) limits this value.

\*\* About MBOX function, refer to section 5.

\*\*\* The rounded error between Point value and the drive parameter cause some difference between write value and set value.

(Note1) Be careful in use of point number 31 and 32 about the following.

 <b>Warning</b>	
 Mandatory	<p>▼ <b>This option designs the unit of "Acceleration/deceleration time" in 0.1sec. Please do not set "10:Acceleration/deceleration time setting 0.01 sec.~600.00sec". in Factory default setting (<math>\text{P} = 10</math>).</b></p> <p>A unit of "Acceleration/deceleration time setting" is changed instantly when set <math>\text{P} = 10</math>.</p> <p>When this option is connected to the inverter, the data unit of Point Number 31 and 32 is changed to "0.01 second".</p> <p>It is possible that it leads to the unexpected machinery operation, and death, a serious wound or equipment parts are damaged.</p>

## 4.2.1. LAO Point Descriptions

Table 5 Logical Analog Output (LAO) Point Descriptions

Point Number	Point Name	Description
01	CTLR ADDRESS	The FLN address of the drive. It can be set from the FLN network and by the panel. *1:F 8 3 4
02	APPLICATION	The Application ID for APG001Z.
20	OVRD TIME	1 of the 5 mandatory FLN points required for compatibility with Siemens control systems. It has no functionality in the drive application.
30	CURRENT LIM	Sets the output current limit of the drive. *1:F 6 0 1
31	ACCEL TIME 1(Note1)	Sets the acceleration time for ramp 1. *1:A C C
32	DECEL TIME 1(Note1)	Sets the deceleration time for ramp 1. *1:d E C
46	AO 1 COMMAND	Controls analog output 1(FM). The FM analog terminal on each inverter can be directly controlled with the computer. To use this function, set the <u>FM terminal meter selection parameter (F 7 5 1)</u> to 31 (communication data output). This makes it possible to send out the data specified as FM analog output data (AO 1 COMMAND) through the FM analog output terminal. Data can be adjusted in a range of 0 to 2047 (resolution of 11 bits). For details, refer to "Meter setting and adjustment" of the instruction manual included with the inverter.
47	AO 2 COMMAND	Controls analog output 2(AM). The AM analog terminal on each inverter can be directly controlled with the computer. To use this function, set the <u>AM terminal meter selection parameter (A 7 5 1)</u> to 31 (communication data output). This makes it possible to send out the data specified as AM analog output data (AO 2 COMMAND) through the AM analog output terminal. Data can be adjusted in a range of 0 to 2047 (resolution of 11 bits). For details, refer to "Meter setting and adjustment" of the instruction manual included with the inverter.
50	PRC PID GAIN	Sets the proportional gain of the PID. *1:F 3 6 2
51	PRC PID ITIM	Sets the integration time of the PID. *1:F 3 6 3
52	PRC PID DTIM	Sets the derivation time of the PID. *1:F 3 6 6
53	(PRC PID DFIL)	Reserved (does not work).
60	INPUT REF1	Sets setpoint 1. This setpoint is enabled at #26 EXT1.2 CMD = 0. For being available, some parameter(s) of the drive command require(s) a specific configuration (setpoint channel 1).
61	INPUT REF2	Sets setpoint 2. This setpoint is enabled at #26 EXT1.2 CMD = 1. For being available, some parameter(s) of the drive command require(s) a specific configuration (setpoint channel 2).
66	SPD OUT MIN	Sets the minimum output speed of the drive as a percentage of the motor nominal rating. *1:L L
67	SPD OUT MAX	Sets the maximum output speed of the drive as a percentage of the motor nominal rating. *1:U U
95	MBOX PARAM	Sets the parameter to be used by the mailbox function. Refer to section 5.
96	MBOX DATA	Sets or indicates the data value of the mailbox function. Refer to section 5.
99	ERROR STATUS	1 of the 5 mandatory FLN points required for compatibility with Siemens control systems. It has no functionality in the drive application.

\*1: When this point was changed, a parameter of the inverter related to this point is changed.

### 4.3. Logical Digital Input (LDI) Summary

Logical Digital Input (LDI) points are used for drive status monitoring such as terminal ON/OFF conditions and fault status. The APG001Z supports 24 different logical digital input points. All LDI points support COV (LDI points are capable of being characterized). LDI points will respond to write point and memorize point commands, but will not change their actual values or indicate override active.

Table 6 Logical Digital Input (LDI) Summary

Point Number	Point Name	Factory Default	Slope	Intercept	ON (1) Text	OFF (0) Test
21	FWD.REV	FWD	1	0	REV	FWD
23	STOP.RUN	STOP	1	0	RUN	STOP
25	EXT1.2 ACT	EXT1	1	0	EXT2	EXT1
27	DRIVE READY	NOTRDY	1	0	READY	NOTRDY
28	AT SETPOINT	NO	1	0	YES	NO
33	HANDAUTO ACT	AUTO	1	0	HAND	AUTO
36	FLN LOC ACT	AUTO	1	0	FLN	AUTO
37	CTL SRC	NO	1	0	YES	NO
38	FLN REF1 SRC	NO	1	0	YES	NO
39	FLN REF2 SRC	NO	1	0	YES	NO
70	DI 1 ACTUAL (F)	OFF	1	0	ON	OFF
71	DI 2 ACTUAL (R)	OFF	1	0	ON	OFF
72	(DI 3 ACTUAL)	OFF	1	0	ON	OFF
73	DI 4 ACTUAL(RES)	OFF	1	0	ON	OFF
74	DI 5 ACTUAL(S1)	OFF	1	0	ON	OFF
75	DI 6 ACTUAL(S2)	OFF	1	0	ON	OFF
76	DO 1 ACTUAL (FL)	OFF	1	0	ON	OFF
77	DO 2 ACTUAL (OUT1)	OFF	1	0	ON	OFF
78	DO 3 ACTUAL(OUT2)	OFF	1	0	ON	OFF
79	DO 4 ACTUAL(R2)	OFF	1	0	ON	OFF
80	DO 5 ACTUAL(OUT5)	OFF	1	0	ON	OFF
81	DO 6 ACTUAL(OUT6)	OFF	1	0	ON	OFF
86	OK.ALARM	OK	1	0	ALARM	OK
93	OK.FAULT	OK	1	0	FAULT	OK

### 4.3.1. LDI Point Descriptions

Table 7 Logical Digital Input (LDI) Point Descriptions

Point Number	Point Name	Description
21	FWD.REV	Indicates the rotational direction of the motor, regardless of control source.
23	STOP.RUN	Indicates the run status of the drive, regardless of control source.
25	EXT1.2 ACT	Indicates whether channel 1 or channel 2 is the active control source.
27	DRIVE READY	Indicates the drive is ready to accept a run command.
28	AT SETPOINT	Indicates the drive has reached its commanded setpoint( <i>F 10 1, F 10 2</i> ).
33	HANDAUTO ACT	Indicates whether the drive is in local (HAND) or remote (AUTO) control.
36	FLN LOC ACT	Indicates if the drive has been placed in "FLN LOCAL" mode by commanding either point 68 (FLN LOC CTL) or point 69 (FLN LOC REF). Commanding either of these points to FLN "steals" control from its normal source and places in under FLN control. Note that the HAND mode of the panel has priority over FLN local control.
37	CTL SRC	Indicates if the FLN network is a source for control inputs.
38	FLN REF1 SRC	Indicates if the FLN network is the source for setpoint 1(Pno.60).
39	FLN REF2 SRC	Indicates if the FLN network is the source for setpoint 2(Pno.61).
70	DI 1 ACTUAL	Indicates the status of digital Input 1. Depending on the status of the F terminal on the drive.
71	DI 2 ACTUAL	Indicates the status of digital Input 2. Depending of the status of the R terminal on the drive.
72	(DI 3 ACTUAL)	Reserved (does not work).
73	DI 4 ACTUAL	Indicates the status of Digital Input 4 (1 = ON, 0 = OFF). Depending on the status of the RES( <i>F 1 1 4</i> ) terminal on the drive.
74	DI 5 ACTUAL	Indicates the status of Digital Input 5 (1 = ON, 0 = OFF). Depending on the status of the S1( <i>F 1 1 5</i> ) terminal on the drive.
75	DI 6 ACTUAL	Indicates the status of Digital Input 6 (1 = ON, 0 = OFF). Depending on the status of the S2( <i>F 1 1 6</i> ) terminal on the drive.
76	DO 1 ACTUAL	Indicates the status of digital output 1. Depending of the status of the FL( <i>F 1 3 2</i> ) terminal on the drive.
77	DO 2 ACTUAL	Indicates the status of digital output 2. Depending of the status of the OUT1( <i>F 1 3 0</i> ) terminal of the drive.
78	DO 3 ACTUAL	Indicates the status of digital output 3 (1 = ON, 0 = OFF). Depending of the status of the OUT2( <i>F 1 3 1</i> ) terminal on the drive.
79	DO 4 ACTUAL	Indicates the status of digital output 4 (1 = ON, 0 = OFF). Depending of the status of the R2( <i>F 1 3 8</i> ) terminal on the drive.
80	DO 5 ACTUAL	Indicates the status of digital output 5 (1 = ON, 0 = OFF). Depending of the status of the OUT5( <i>F 1 3 6</i> ) terminal on the drive.
81	DO 6 ACTUAL	Indicates the status of digital output 6 (1 = ON, 0 = OFF). Depending of the status of the OUT6( <i>F 1 3 7</i> ) terminal on the drive.
86	OK.ALARM	Indicates the current alarm state of the drive.
93	OK.FAULT	Indicates the current fault state of the drive.

## 4.4. Logical Digital Output (LDO) Summary

Logical Digital Output (LDO) points are used for executing drive commands such as RUN/STOP and trip clear. The APG001Z supports 18 different logical digital output points (17 among them are for drive control, one special point is reserved for maintaining compliance). The values of all logical digital output points can be modified by write point or memorize point commands. Release commands will not cause the logical digital output points to automatically return to their pre-override values. LDO points do not support COV.

Table 8 Logical Digital Output (LDO) Summary

Point Number	Point Name	Factory Default	Slope	Intercept	ON (1) Text	OFF (0) Test
22	CMD FWD.REV	FWD	1	0	REV	FWD
24	CMD STP.STRT	STOP	1	0	RUN	STOP
26	EXT1.2 CMD	EXT1	1	0	EXT2	EXT1
<b>29</b>	<b>DAY.NIGHT</b>	<b>DAY</b>	<b>1</b>	<b>0</b>	<b>NIGHT</b>	<b>DAY</b>
40	DO 1 COMMAND (OUT1) *	OFF	1	0	ON	OFF
41	DO 2 COMMAND (OUT2) *	OFF	1	0	ON	OFF
42	DO 3 COMMAND (FL) *	OFF	1	0	ON	OFF
43	DO 4 COMMAND (OUT3) *	OFF	1	0	ON	OFF
44	DO 5 COMMAND (OUT4) *	OFF	1	0	ON	OFF
45	DO 6 COMMAND (R1) *	OFF	1	0	ON	OFF
48	(RST RUN TIME)	NO	1	0	RESET	NO
49	RESET KWH	NO	1	0	RESET	NO
59	LOCK PANEL	UNLOCK	1	0	LOCK	UNLOCK
68	FLN LOC CTL	AUTO	1	0	FLN	AUTO
69	FLN LOC REF	AUTO	1	0	FLN	AUTO
94	RESET FAULT	NO	1	0	RESET	NO
97	MBOX READ	DONE	1	0	READ	DONE
98	MBOX WRITE	DONE	1	0	WRITE	DONE

\* Example:

Set the parameter  $F \ 130$  (OUT1 terminal) = 92 (93).

Set the parameter  $F \ 131$  (OUT2 terminal) = 94 (95).

Set the parameter  $F \ 132$  (FL terminal) = 96 (97).

Set the parameter  $F \ 133$  (OUT3 terminal) = 98 (99).

Set the parameter  $F \ 134$  (OUT4 terminal) = 100 (101).

Set the parameter  $F \ 135$  (R1 terminal) = 102 (103).



#### 4.4.1. LDO Point Descriptions

Table 9 Logical Digital Output (LDO) Point Descriptions

Point Number	Point Name	Parameter
22	CMD FWD.REV	Commanded from the FLN network to change the rotational direction of the drive. This command is active only if the drive is configured for control from the FLN network.
24	CMD STP.STRT	Commanded from the FLN network to start the drive. This command is active only if the drive is configured for control from the FLN network. When an inverter is a trip, a stop (=0) is set automatically.
26	EXT1.2 CMD	Commanded from the FLN network to select channel 1 or channel 2 as the active control source (0 = #60 INPUT REF1, 1 = #61 INPUT REF2).
29	DAY.NIGHT	<b>1 of the 5 mandatory FLN points required for compatibility with Siemens control systems. It has no functionality in the drive application.</b>
40	DO 1 COMMAND	The data of this point is outputted to the terminal which chose the designated data output 1 (Output-terminal selection number: 92(93)). For example,when you control the output of an OUT1 terminal , please set the parameter $F 130$ (OUT1 terminal) = 92 (93).
41	DO 2 COMMAND	The data of this point is outputted to the terminal which chose the designated data output 2 (Output-terminal selection number: 94(95)). For example,when you control the output of an OUT2 terminal, please set the parameter $F 131$ (OUT2 terminal) = 94 (95).
42	DO 3 COMMAND	The data of this point is outputted to the terminal which chose the designated data output 3 (Output-terminal selection number: 96(97)). For example,when you control the output of an FL terminal, please set the parameter $F 132$ (FL terminal) = 96 (97).
43	DO 4 COMMAND	The data of this point is outputted to the terminal which chose the designated data output 4 (Output-terminal selection number: 98(99)). For example,when you control the output of an OUT3 terminal, please set the parameter $F 133$ (OUT3 terminal) = 98 (99).
44	DO 5 COMMAND	The data of this point is outputted to the terminal which chose the designated data output 5 (Output-terminal selection number: 100(101)). For example,when you control the output of an OUT4 terminal, please set the parameter $F 134$ (OUT4 terminal) = 100 (101).
45	DO 6 COMMAND	The data of this point is outputted to the terminal which chose the designated data output 6 (Output-terminal selection number: 102(103)). For example,when you control the output of an R1 terminal, please set the parameter $F 135$ (R1 terminal) = 102 (103).
48	RST RUN TIME	Reserved (does not work).
49	RESET KWH	Commanded by the FLN network to reset the cumulative kilowatt-hour and megawatt-hours counter (1 = RESET, 0 = NO). The control input is rising-edge sensitive, so, once the command is issued, this point automatically returns to its inactive state. This "momentary" operation avoids any need for an explicit command to clear the point before a subsequent reset can be issued.
59	LOCK PANEL	Command from the FLN network to lock the panel and prevent parameter changes (1 = LOCK, 0 = UNLOCK).
68	FLN LOC CTL	Commanded from the FLN network to temporarily "steal" start/stop control of the drive from its normal source and place it under FLN network control. This functionality is analogous to placing the drive in HAND mode at the panel, with the control being taken by the FLN network instead. HAND mode at the panel has priority over this point. Thus, this point is only effective in temporarily taking control from the digital inputs or some other internal control functionality.

69	FLN LOC REF	<p>Commanded from the FLN network to temporarily "steal" input setpoint control of the drive from its normal source and place it under the FLN network control.</p> <p>This functionality is analogous to placing the drive in HAND mode at the panel, with the setpoint control being taken from the FLN network instead. HAND mode at the panel has priority over this point. Thus, this point is only effective in temporarily taking control from the analog inputs or some other internal control functionality.</p>
94	RESET FAULT	<p>Command from the FLN network to reset a faulted drive (1 = RESET, 0 = NO).</p> <p>The control input is rising-edge sensitive, so, once the command is issued, this point automatically returns to its inactive state. This "momentary" operation avoids any need for an explicit command to clear the point before a subsequent reset can be issued.</p>
97	MBOX READ	Refer to section 5.
98	MBOX WRITE	Refer to section 5.

---

## 4.5. FLN P1 Error Codes

---

When an operation as a result of a P1 command fails, an error code is returned with the NAK.

Below is a list of all possible error codes that can be returned by a FLN device.

Table 10 FLN P1 Error Code

Error Code	Description
D7 <sub>H</sub>	Operator priority too low. A number of situations can return this error code.
F9 <sub>H</sub>	Invalid point number.
FB <sub>H</sub>	No COVs to report.
FC <sub>H</sub>	Request Characterization.
FD <sub>H</sub>	Invalid command.
FE <sub>H</sub>	Invalid value. *

\* Including the response for Dump Memory command (18<sub>H</sub>) and Modify Memory command (19<sub>H</sub>). APG001Z does not support these commands.

## 5. Mailbox Function Points

Using below APOGEE® FLN points, inverter parameters can be read and written.

Table 11 VF-PS1 Parameter Access Point Table

Point Number	Point Type	Point Name	Note
95	LAO	MBOX PARAM	The communication number (hex.) of the access parameter is set. Refer to "5.1" and the inverter instruction manual.
96	LAO	MBOX DATA	The parameter's data. The data unit is depend on the parameter specification. Refer to "5.1" and the inverter instruction manual.
97	LDO	MBOX READ	The parameter value specified by MBOX PARAM is read to MBOX DATA by setting 1(READ). When the data is read in normally this point is changed from 1 to 0, otherwise this point remains 1.
98	LDO	MBOX WRITE	When 1(WRITE) is set in MBOX WRITE, data of MBOX DATA is written to the parameter of MBOX PARAM. As for the parameter having an EEPROM, the data is written RAM, after that the data is written to. (Note 1). When the data is written in normally this point is changed from 1 to 0, otherwise this point remains 1.

(Note1): Please do the inverter cannot start (for example "ST terminal =OFF") at writing the parameter that commands to the inverter to drive and is inhibited during driving. If not, the data is only written RAM and this point remains 1.

### Example 1) Read the deceleration time ( $dE \zeta$ , Comm. No. 0010)

- Write "16" as the communication number to MBOX PARAM (LAO #95).  
\* The communication number uses the value of a decimal number set to "10" by the hexadecimal number. 0x0010 = 16 dec.
- Write "1" to MBOX READ (LDO #97).
- Confirm whether it was read in MBOX READ (LDO #97).
- The read value is set to MBOX DATA (LAO #96). Read MBOX DATA (LAO #96). In addition, the unit of **deceleration time** is 0.1s.

### Example 2) Write "50.0Hz" to RX input point 2 ( $F \zeta 19$ , Comm. No. 0219)

- Write "537" as the communication number to MBOX PARAM (LAO #95).  
\* 0x0219 = 537 dec.
- Write "5000" to MBOX WRITE (LDO #98).  
\* 5000 = 50.00Hz, unit is 0.01Hz
- Write "1" to MBOX WRITE (LDO #98).

## 5.1. Parameter data

It is explanation by the reference method of the list of parameters of the VF-PS1 series as follows. For communication purposes, see the parameter list on inverter's instruction manual regarding the communication number, adjustment range and so forth.

<Example of excerpts from the inverter's instruction manual>

Title	Communication No.	Function	Adjustment range	Minimum setting unit (Panel/Communication)	Default setting	Write during running	Reference
$RUH$	-	History function		1/1	-	-	5.1
$RU1$	0000	Automatic acceleration/deceleration	0:Deselect 1:Automatic setting 2:Automatic setting (during acceleration only)	1/1	0	Disabled	5.2
$RU2$	0001	Automatic torque boost	0:Deselect 1:Automatic torque boost + auto-tuning 1	1/1	-	Disabled	5.3
				⋮	⋮		
$dEC$	0010	Deceleration time 1	0.1~6000 sec.	0.1/0.1 *2	*1	Enabled	5.2
$tYP$	0007	Factory default setting	0: - 1:50 Hz default setting 2:60 Hz default setting 3:Factory default setting ⋮ 10:Acceleration/deceleration time setting 0.01 sec.~600.0 sec. 11:Acceleration/deceleration time setting 0.1 sec.~6000sec.	1/1	-	Disabled	5.20
				⋮			

\*1: Default values vary depending on the capacity.  
\*2: Changing the parameter  $tYP$  enables to set to 0.01 sec. (adjustment range: 0.01~600.0 sec.).

- (1) "Title" means the display on the inverter panel.
- (2) "Communication number" is affixed to each parameter that is necessary for designating the parameter for communication.
- (3) "Adjustment range" means a data range adjustable for a parameter, and the data cannot be written outside the range. The data have been expressed in the decimal notation. For writing the data through the communication function, take the minimum setting unit into consideration, and use hexadecimal system.
- (4) "Minimum setup unit" is the unit of a single data (when the minimum unit is "-", 1 is equal to 1). For example, the "minimum setup unit" of acceleration time ( $dEC$ ) is 0.01, and 1 is equal to 0.01s. For setting a data to 10 seconds, transmit 03E8h [ $10 \div 0.01 = 1000d = 03E8h$ ] by communication.

### Warning

  
Mandatory

▼ This option designs the unit of "Acceleration/deceleration time" in 0.1sec. Please do not set "10:Acceleration/deceleration time setting 0.01 sec.~600.00sec". in Factory default setting ( $tYP=10$ ).  
A unit of "Acceleration/deceleration time setting" is changed instantly when set  $tYP=10$ .  
When this option is connected to the inverter, the data unit of Point Number 31 and 32 is changed to "0.01 second".  
It is possible that it leads to the unexpected machinery operation, and death, a serious wound or equipment parts are damaged.

## 6. Frame counter monitor

Valid and invalid frame counter can be monitored by the drive monitor function.  
Please refer to “Monitoring the operation status” of the drive instruction manual about the detail.

Press “MODE” key twice.

Item display	Key operation	LED display	Description
---	---	60.0	The operation frequency is displayed (Operation at 60Hz). (When standard monitor display selection <i>F 7 10</i> is set at 0 [operation frequency])
Parameter setting mode	“MODE”	<i>RUF</i>	The first basic parameter “ <i>RUF</i> ” (Wizard function) is displayed.
Direction of rotation	“MODE”	<i>F r - F</i>	The direction of rotation is displayed. ( <i>F r - F</i> : forward run, <i>F r - r</i> : reverse run)
Frame counter	“UP”	<i>n 50</i>	Displays the frame counter numbers of communication through the network. (example) : In the case of 50 counts. In the case of <i>F 7 1 1</i> =72 [a communication option reception counter] setting.
Invalid frame counter	“UP”	<i>n 50</i>	Displays the invalid frame counter numbers of communication through the network. (example) : In the case of 50 counts. In the case of <i>F 7 1 2</i> =73 [a Communication option Error counter] setting)

## 7.VF-PS1 Alarm code

Table 12 ALARM WORD 1(Pno.88) Table

Bit	Specifications	0	1	Remarks (Code displayed on the panel)
0	Over-current alarm	Normal	Alarming	$\underline{I}$ flickering
1	Inverter overload alarm	Normal	Alarming	$\underline{L}$ flickering
2	Motor overload alarm	Normal	Alarming	$\underline{L}$ flickering
3	Overheat alarm	Normal	Alarming	$\underline{H}$ flickering
4	Overvoltage alarm	Normal	Alarming	$\underline{P}$ flickering
5	Main circuit undervoltage alarm	Normal	Alarming	-
6	(Reserved)	-	-	-
7	Low current alarm	Normal	Alarming	-
8	Over-torque alarm	Normal	Alarming	-
9	Braking resistor overload alarm	Normal	Alarming	-
10	Cumulative operation hours alarm	Normal	Alarming	-
11	(Reserved)	-	-	-
12	(Reserved)	-	-	-
13	(Reserved)	-	-	-
14	At the time of the instant blackout, Forced deceleration/stop	-	Decelerating, stopping	$\underline{L S E P}$ flickering
15	An automatic stop during the lower limit frequency continuance	-	Decelerating, stopping	$\underline{S E O P}$ flickering

Table 13 ALARM WORD 2(Pno.89) Table

Bit	Specifications	0	1	Remarks (Code displayed on the panel)
0	(Reserved)	-	-	-
1	(Reserved)	-	-	-
2	Life time alarm	Normal	Alarming	-
3	Over torque alarm	Normal	Alarming	-
4	Over load stall alarm	Normal	Alarming	-
5	Control circuit option alarm	Normal	Alarming	$\underline{C O F F}$ flickering
6	PTC alarm	Normal	Alarming	-
7	VI/II input disconnection alarm	Normal	Alarming	-
8-15	(Reserved)	-	-	-

※Do not use "reserved" bit

## 8. VF-PS1 Fault code

Table 14 VF-PS1 Fault Code Table (Pno.90,91,92)

Data (Dec)	Data (Hex)	Description	Display
0	0	No error	nErr
1	1	Over-current during acceleration	OL1
2	2	Over-current during deceleration	OL2
3	3	Over-current during constant speed operation	OL3
4	4	Over-current in load at startup	OLL
5	5	U-phase arm overcurrent	OLR1
6	6	V-phase arm overcurrent	OLR2
7	7	W-phase arm overcurrent	OLR3
8	8	Input phase failure	EPH1
9	9	Output phase failure	EPHO
10	A	Overvoltage during acceleration	OP1
11	B	Overvoltage during deceleration	OP2
12	C	Overvoltage during constant speed operation	OP3
13	D	Over-LOAD in inverter	OL1
14	E	Over-LOAD in motor	OL2
15	F	Dynamic braking resistor overload	OLr
16	10	Overheat	OH
17	11	Emergency stop	E
18	12	EEPROM fault	EEP1
19	13	Initial read error	EEP2
20	14	Initial read error	EEP3
21	15	Inverter RAM fault	Err2
22	16	Inverter ROM fault	Err3
23	17	CPU fault	Err4
24	18	Communication time-out error	Err5
25	19	Gate array fault	Err6
26	1A	Output current detector error	Err7
27	1B	Option error	Err8
29	1D	Low current operation status	UL
30	1E	Undervoltage (main circuit)	UP1
32	20	Over-torque trip	Ut
33	21	Ground fault trip	EF1
34	22	Ground fault trip	EF2
36	24	Dynamic braking abnormal element	OLr
37	25	Overcurrent during acceleration (element overheat)	OL1P
38	26	Overcurrent during deceleration (element overheat)	OL2P
39	27	Overcurrent during fixed speed operation (element overheat)	OL3P
40	28	Tuning error	Et <sub>n</sub>
41	29	Inverter type error	EEYP
42	2A	Analog input terminal overvoltage	E-10
43	2B	Abnormal brake sequence	E-11
44	2C	Disconnection of encoder	E-12
45	2D	Speed error	E-13
46	2E	External thermal	OH2
47	2F	Step-out (for PM motors only)	SOUt
50	32	Terminal input error	E-18
51	33	Abnormal CPU2 communication	E-19
52	34	V/f control error	E-20
53	35	CPU1 fault	E-21
54	36	Abnormal logic input voltage	E-22
55	37	Option 1 error	E-23
56	38	Option 2 error	E-24
57	39	Stop position retaining error	E-25
58	3A	CPU2 fault	E-26
61	3D	Control circuit option error	E-29
84	54	F4 10 tuning error	Et <sub>n1</sub>
85	55	F4 12 tuning error	Et <sub>n2</sub>
86	56	Motor constant setting error	Et <sub>n3</sub>



---

## 9. Unusual diagnosis

---

The VF-PS1 is able to install two kind options. The option error message is depended on the position of the option under or panel side.

---

### 9.1. Option error

---

The error message is displayed when there is hardware error, software error or lose of connection of wire.

When an option and a combination of the inverter are bad, it is displayed.

Please use VF-PS1 that version number is bigger than V620.

#### ■ Display of trip information

$E - 23$  (Error code : 55) : Add-on option 1 error

(This error is displayed at the time the bottom side option has an error or only one option is installed and has an error.)

$E - 24$  (Error code : 56) : Add-on option 2 error

(This error is displayed at the time the two-units are installed and the upper side option has an error.)

---

### 9.2. Disconnection error of network cable

---

When network trouble occurred by disconnection etc, the inverter does emergency stop with the following indication when the network disconnection detection ( $F 832$ ) is set, and it was set in ( $F 851=4$ ).

#### ■ Display of trip information

$E r r 8$  (Error code : 27) : Communication error

## 10. Command & Setpoint selection (Local/Remote)

Indication to display Local/Remote mode is on the inverter unit (Refer to the inverter instruction manual for details). APOGEE® FLN option command and setpoint are activated on Remote mode.

Inverters have some switches to select the command and setpoint location. Following figure shows the diagram. Refer to the inverter instruction manual for the parameter in detail.

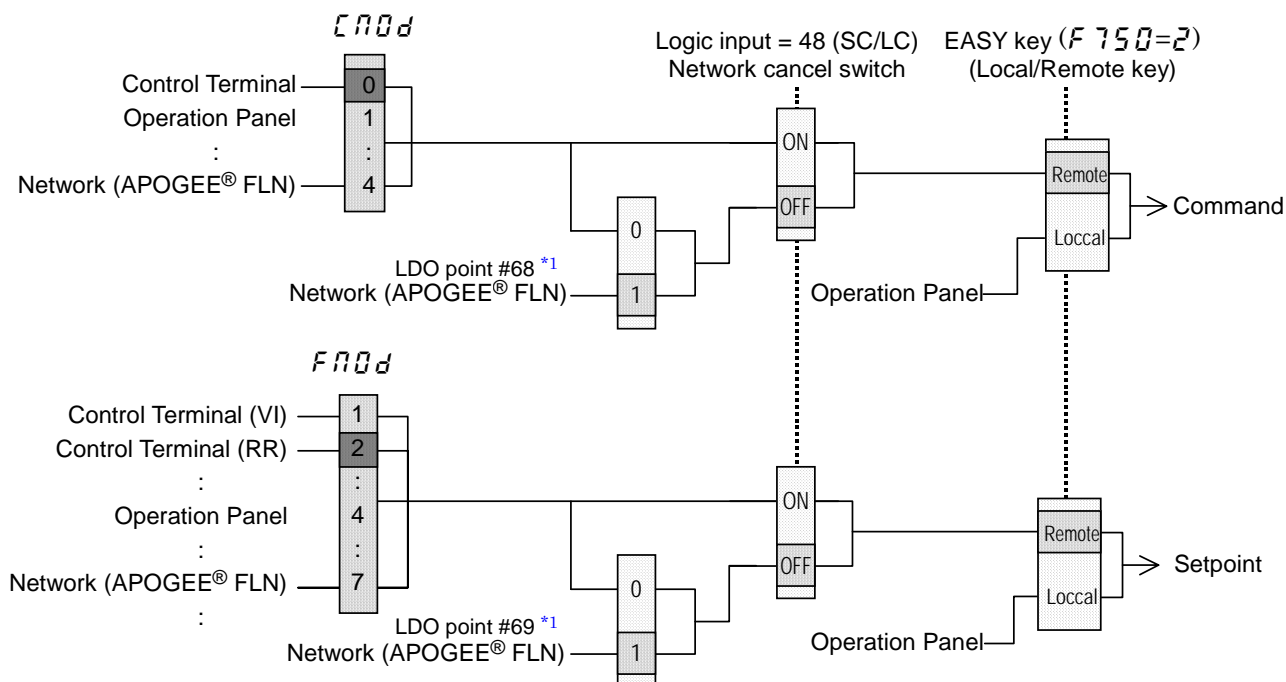

\*1 Be careful that *CnOd* command and *FnOd* setpoint are activated for a short time just after the inverter power turned on. Set *CnOd* and *FnOd* to “network” to prevent this problem.

## &lt;Example&gt;

The example below shows how to configure the VF-PS1 for local/remote operation.

F terminal..... Operating command

R terminal ..... The APOGEE® FLN local/remote (Terminal in this example) switching

RR/S4 terminal..... Operation frequency command

## &lt;Wiring&gt;

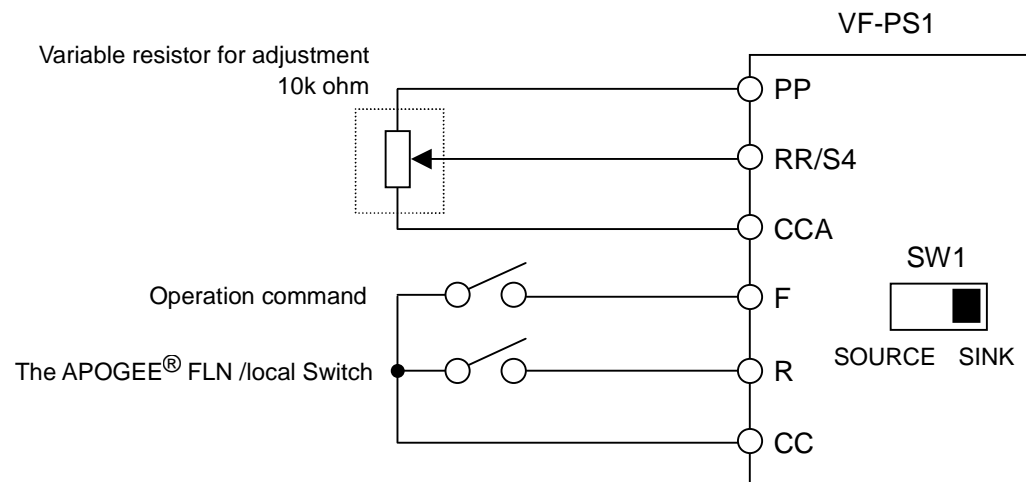

## &lt;Parameter setting&gt;

$F 7 5 0 = 2$  (Command mode selection) = 0 (Terminal board)

$F 7 5 1 = 2$  (Frequency setting mode selection 1) = 2 (RR/S4)

$F 1 1 2$  (Input terminal selection 2 (R)) = 48 (Remote/Local control)

## &lt;Operation&gt;

R-CC terminal open: VF-PS1 is controlled as a slave device of The APOGEE® FLN.

R-CC terminal closed:

F-CC terminal short to RUN

F-CC terminal open to STOP

Output frequency is set up by the RR/S4 signal input.

## (Note)

When the local(HAND) / remote key ( $F 7 5 0 = 2$ ) is chosen as EASY key selection and the EASY key lamp of an inverter front panel is on, priority is most given to operation by a panel. (Refer to the inverter instruction manual for details).

Note that the HAND mode of the panel has priority over FLN local control.

## 11. Specifications

### < Environmental specification >

Item	Specification
Model number	APG001Z
Service environment	Conforms to VF-PS1
Ambient temperature	Conforms to VF-PS1
Storage temperature	Conforms to VF-PS1
Relative humidity	Conforms to VF-PS1
Vibration	Conforms to VF-PS1
Power supply	24VDC supplied from the inverter

### <APG001Z network specification >

Item	Specification
Station type	Remote device station
Number of occupied stations	1 station occupied by 1 unit
Maximum FLN device	32 FLN devices to each FLN port of the Field Cabinet.
Communication baud rate	4800, 9600, 19200, 38400, 57600, 76800bps
Bias resistor and termination	Local bias resistors are mounted. Termination resistor (120 ohm) can be select by SW.
Terminal block	Detachable terminal block 4-pole (5.08mm pitch) Manufacturer: PHOENIX CONTACT Type-Form : MSTB 2,5/4-STF-5.08