

MELSEC QnA Series

Programmable Controller

Programming Manual
(Special Function module)

QnACPU

REVISIONS

*The manual number is given on the bottom left of the back cover.

Print Date	*Manual Number	Revision
Jul., 1996	IB (NA) 66616-A	First edition

SAFETY CAUTIONS

(You must read these cautions before using the product)

In connection with the use of this product, in addition to carefully reading both this manual and the related manuals indicated in this manual, it is also essential to pay due attention to safety and handle the product correctly.

The safety cautions given here apply to this product in isolation. For information on the safety of the PC system as a whole, refer to the CPU module User's Manual.

These **SAFETY CAUTIONS** are classified into two grades: "DANGER" and "CAUTION".



DANGER

Safety caution given when incorrect handling could result in hazardous situations involving the possibility of death or serious injury.



CAUTION

Safety caution given when incorrect handling could result in hazardous situations involving the possibility of moderate or light injury or damage to property.

Note that, depending on the circumstances, failing to follow a  **CAUTION** may also have very serious consequences.

Both of these classes of safety caution are very important and must be observed.

Store this manual carefully in a place where it is accessible for reference whenever necessary, and forward a copy of the manual to the end user.

[System Design Precautions]



- Safety circuits should be installed external to the programmable controller to ensure that the system as a whole will continue to operate safely in the event of an external power supply malfunction or a programmable controller failure. Erroneous outputs and operation could result in an accident.

1) The following circuitry should be installed outside the programmable controller:

Interlock circuitry for the emergency stop circuit protective circuit, and for reciprocal operations such as forward/reverse, etc., and interlock circuitry for upper/lower positioning limits, etc., to prevent machine damage.

2) When the programmable controller detects an abnormal condition, processing is stopped and all outputs are switched OFF. This happens in the following cases:

- When the power supply module's over-current or over-voltage protection device is activated.
- When an error (watchdog timer error, etc.) is detected at the PC CPU by the self-diagnosis function.

Some errors, such as input/output control errors, cannot be detected by the PC CPU, and there may be cases when all outputs are turned ON when such errors occur. In order to ensure that the machine operates safely in such cases, a failsafe circuit or mechanism should be provided outside the programmable controller. Refer to the CPU module user's manual for an example of such a failsafe circuit.

3) Outputs may become stuck at ON or OFF due to an output module relay or transistor failure. An external circuit should therefore be provided to monitor output signals whose incorrect operation could cause serious accidents.

- A circuit should be installed which permits the external power supply to be switched ON only after the programmable controller power has been switched ON. Accidents caused by erroneous outputs and motion could result if the external power supply is switched ON first.

- When a data link communication error occurs, the status shown below will be established at the faulty station. In order to ensure that the system operates safely at such times, an interlock circuit should be provided in the sequence program (using the communication status information).

Erroneous outputs and operation could result in an accident.

1) The data link data which existed prior to the error will be held.

2) All outputs will be switched OFF at MELSECNET (II, /B, /10) remote I/O stations.

3) At the MELSECNET/MINI-S3 remote I/O stations, all outputs will be switched OFF or output statuses will be held, depending on the E.C. mode setting.

For details on procedures for checking faulty stations, and for operation statuses when such errors occur, refer to the appropriate data link manual.

[System Design Precautions]



CAUTION

- Do not bundle control lines or communication wires together with main circuit or power lines, or lay them close to these lines.
As a guide, separate the lines by a distance of at least 100 mm, otherwise malfunctions may occur due to noise.

[Cautions on Mounting]



CAUTION

- Use the PC in an environment that conforms to the general specifications in the manual.
Using the PC in environments outside the ranges stated in the general specifications will cause electric shock, fire, malfunction, or damage to/deterioration of the product.
- Make sure that the module fixing projection on the base of the module is properly engaged in the module fixing hole in the base unit before mounting the module.
Failure to mount the module properly will result in malfunction or failure, or in the module falling.
- Extension cables should be securely connected to base unit and module connectors. Check for loose connection after installation.
A poor connection could result in contact problems and erroneous inputs/outputs.
- Plug the memory cassette firmly into the memory cassette mounting connector. Check for loose connection after installation.
A poor connection could result in erroneous operation.
- Plug the memory firmly into the memory socket. Check for loose connection after installation.
A poor connection could result in erroneous operation.

[Cautions on Wiring]



DANGER

- Switch off the external power supply before starting installation and wiring work.
Failure to do so could result in electrical shocks and equipment damage.
- After installation and wiring is completed, be sure to attach the terminal cover before switching the power ON and starting operation.
Failure to do so could result in electrical shocks.



CAUTION

- Be sure to ground the FG and LG terminals, carrying out at least class 3 grounding work with a ground exclusive to the PC.
Otherwise there will be a danger of electric shock and malfunctions.
- Carry out wiring to the PC correctly, checking the rated voltage and terminal arrangement of the product.
Using a power supply that does not conform to the rated voltage, or carrying out wiring incorrectly, will cause fire or failure.
- Outputs from multiple power supply modules should not be connected in parallel. Failure to do so could cause the power supply module to overheat, resulting in a fire or module failure.
- Tighten the terminal screws to the stipulated torque.
Loose screws will cause short circuits, fire, or malfunctions.
- Make sure that no foreign matter such as chips or wiring offcuts gets inside the module.
It will cause fire, failure or malfunction.
- Connectors for external connections should be crimped, pressure welded, or soldered in the correct manner using the correct tools.
For details regarding crimping and pressure welding tools, refer to the input/output module user's manual.
A poor connection could cause shorts, fire, and erroneous operation.

[Cautions on Startup and Maintenance]



- Do not touch terminals while the power is ON.
This will cause malfunctions.
- Make sure that the battery is connected properly. Do not attempt to charge or disassemble the battery, do not heat the battery or place it in a flame, and do not short or solder the battery.
Incorrect handling of the battery can cause battery heat generation and ruptures which could result in fire or injury.
- Switch the power off before cleaning or re-tightening terminal screws.
Carrying out this work while the power is ON will cause failure or malfunction of the module.



- In order to ensure safe operation, read the manual carefully to acquaint yourself with procedures for program changes, forced outputs, RUN, STOP, and PAUSE operations, etc., while operation is in progress.
Incorrect operation could result in machine failure and injury.
- Do not disassemble or modify any module.
This will cause failure, malfunction, injuries, or fire.
- Switch the power OFF before mounting or removing the module.
Mounting or removing it with the power ON can cause failure or malfunction of the module.
- When replacing fuses, be sure to use the prescribed fuse. A fuse of the wrong capacity could cause a fire.

[Cautions on Disposal]



- Dispose of this product as industrial waste.

INTRODUCTION

Thank you for choosing the Mitsubishi MELSEC-QnA Series of General Purpose Programmable Controllers. Please read this manual carefully so that the equipment is used to its optimum. A copy of this manual should be forwarded to the end User.

CONTENTS

1.	GENERAL DESCRIPTION	1-1 ~ 1-1
1.1	Related Programming Manuals	1-1
2.	LIST OF SPECIAL FUNCTION MODULE INSTRUCTIONS	2-1 ~ 2-10
2.1	Classification of Instructions	2-1
2.2	How to Read Instruction Tables	2-2
2.3	List of Special Function Module Instructions	2-4
3.	CONFIGURATION OF INSTRUCTIONS	3-1 ~ 3-3
3.1	Instruction Configuration	3-1
3.2	Instruction Execution Conditions	3-2
3.3	Number of Steps	3-3
4.	HOW TO READ EXPLANATIONS FOR INSTRUCTIONS	4-1 ~ 4-3
5.	AD61(S1) CONTROL INSTRUCTIONS	5-1 ~ 5-7
5.1	Setting Preset Value Data	PVWR1, PVWR2 .. 5-2
5.2	Setting Set Value Data for Greater/Smaller/Equal Judgments	SVWR1, SVWR2 .. 5-4
5.3	Reading Present Value	PVRD1, PVRD2 .. 5-6
6.	AD59(S1) CONTROL INSTRUCTIONS	6-1 ~ 6-13
6.1	Sending to the Printer any Number of Character Data	PRN
6.2	Sending to the Printer Characters up to "00H" Code	PR
6.3	Reading Data from Memory Card	GET
6.4	Writing Data to a Memory Card	PUT
7.	AJ71PT32-S3 CONTROL INSTRUCTIONS	7-1 ~ 7-31
7.1	Key Input from Operation Box	INPUT
7.2	No-Protocol Mode Data Send of Designated Number of Bytes	PRN
7.3	No-Protocol Mode Data Send up until "00H" Code	PR
7.4	No-Protocol Mode Data Receive	INPUT
7.5	Remote Terminal Module Communication	MINI
7.6	Remote Terminal Module Error Reset	MINIERR
7.7	Reading Communication Status	SPBUSY
7.8	Forced Stop of Communication Processing	SPCLR
8.	AJ71C21(S1) CONTROL INSTRUCTIONS	8-1 ~ 8-23
8.1	Sending Designated Number of Bytes of Data	PRN2, PRN4
8.2	Data Send up to "00H" Code	PR2, PR4
8.3	Receiving Data	INPUT2, INPUT4
8.4	Read RAM Memory	GET
8.5	Write to RAM Memory	PUT

8.6	Reading Communication Status	SPBUSY	8-20
8.7	Forced Stop of Communication Processing	SPCLR	8-22
9.	COMPUTER LINK MODULE CONTROL INSTRUCTIONS		9-1 ~ 9-18
9.1	No-Protocol Mode Data Send of Designated Number of Bytes . PRN		9-2
9.2	No-Protocol Mode Data Send Up until "00H" Code	PR	9-6
9.3	No-Protocol Mode Data Receive	INPUT	9-10
9.4	Reading Communication Status	SPBUSY	9-15
9.5	Forced Cancellation of Communications Processing	SPCLR	9-17
10.	AJ71QC24 CONTROL INSTRUCTIONS		10-1 ~ 10-55
10.1	Writing User Registration Frame to EEPROM	PUTE	10-6
10.2	Reading User Registration Frame from EEPROM	GETE	10-10
10.3	Data Send by Dedicated Protocol On-Demand Function	ONDEMAND	10-13
10.4	Sending Designated Number of Data in No-Protocol Mode	OUTPUT	10-16
10.5	Data Send Using Send Schedule Table in No-Protocol Mode ..	PRR	10-19
10.6	Data Receive in No-Protocol Protocol	INPUT	10-22
10.7	Data Send of Designated Number of Data in Bidirectional Protocol	BIDOUT	10-25
10.8	Data Receive in Bidirectional Protocol	BIDIN	10-28
10.9	Read Communications Status	SPBUSY	10-31
10.10	Reading Devices at Other Stations	READ	10-33
10.11	Writing to Other Station Devices	SWRITE	10-37
10.12	Sending Data to Other Stations	SEND	10-42
10.13	Receiving Data From Other Stations	RECV	10-46
10.14	Other Station Transient Transmission Request	REQ	10-50
11.	ID INTERFACE MODULE INSTRUCTIONS		11-1 ~ 11-17
11.1	ID Controller Initial Setting	IDINIT1, IDINIT2	11-2
11.2	Reading from ID Data Carrier	IDRD1, IDRD2	11-4
11.3	Writing to ID Data Carrier	IDWD1, IDWD2	11-6
11.4	Continuous Reading from ID Data Carrier	IDARD1, IDARD2	11-8
11.5	Continuous Writing to ID Data Carrier	IDAWD1, IDAWD2 ..	11-10
11.6	Data Comparison with ID Data Carrier	IDCMP1, IDCMP2 ..	11-12
11.7	Batch Writing Same Data to ID Data Carrier	IDFILL1, IDFILL2 ..	11-14
11.8	Copying between ID Data Carriers	IDCOPY1, IDCOPY2	11-16
APPENDIX		APP-1 ~ APP-1
APPENDIX 1	LIST OF PROCESSING TIMES		APP-1

1. GENERAL DESCRIPTION

This manual describes instructions that are useful when using a special function module with a QnACPU.

Section 2.3 lists the instructions described in this manual:
see Section 2.3 for details of the instructions which can be used.

1.1 Related Programming Manuals

- QnACPU Programming Manual (Fundamentals)
- QnACPU Programming Manual (Common Instructions)
- QnACPU Programming Manual (PID Control Instructions)
- QnACPU Programming Manual (AD57 Instructions)
- QnACPU Programming Manual (SFC)

Before reading this manual, it is advisable to review the QnACPU Programming Manual (Fundamentals) to confirm what programs can be used with QnACPU, input/output processing, and basic information on devices.

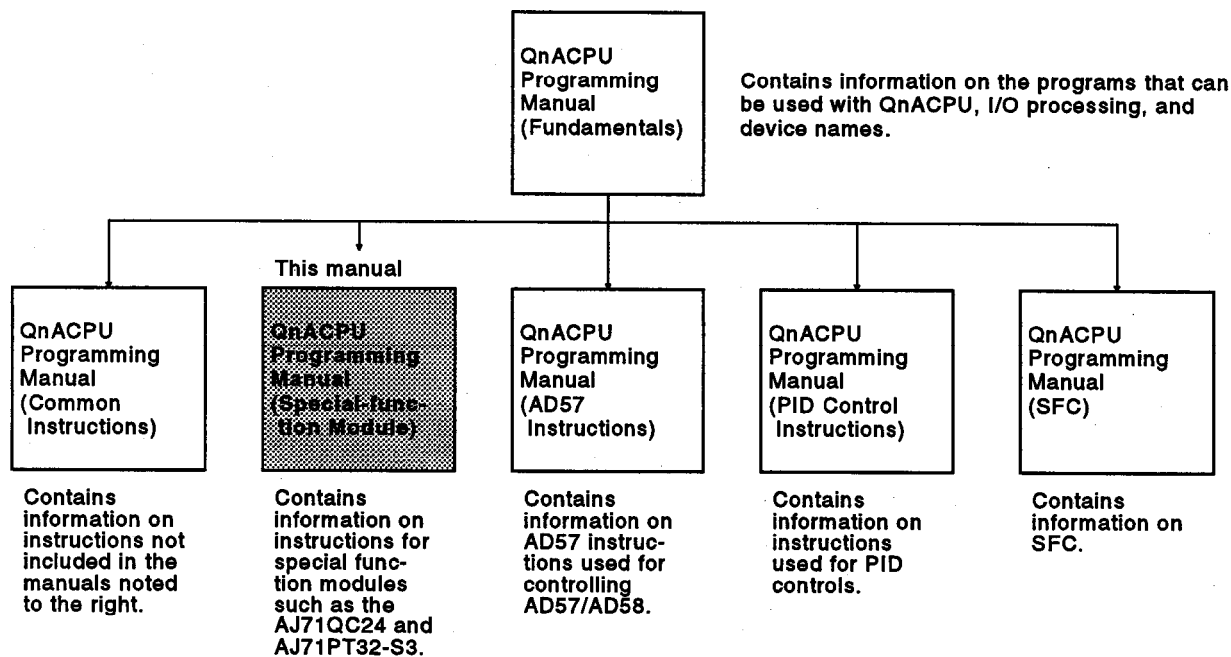

2. LIST OF SPECIAL FUNCTION MODULE INSTRUCTIONS

MELSEC-QnA

2. LIST OF SPECIAL FUNCTION MODULE INSTRUCTIONS

This chapter lists the instructions for special function modules.

2.1 Classification of Instructions

The instructions for special function modules can be broadly divided into the following.

Classification of Instructions	Processing Details	Description
AD61(S1) control instructions	Read count values and write set value data and preset data.	Chapter 5
AD59(S1) control instructions	Send data to the printer, read/write data from/to the memory card.	Chapter 6
AJ71PT32-S3 control instructions	Conduct data communications with the MELSECNET/MINI-S3 data link system remote terminal modules.	Chapter 7
AJ71C21(S1) control instructions	Communicate with external devices in the no-protocol mode and read/write data from/to RAM memory.	Chapter 8
Computer link module instructions	Communicate with external devices in no-protocol mode.	Chapter 9
AJ71QC24 control instructions	Conduct data communication with external devices connected to AJ71QC24, or between AJ71QC24s.	Chapter 10
ID interface module instructions	Read/write ID data through an ID controller to an ID data carrier.	Chapter 11





2. LIST OF SPECIAL FUNCTION MODULE INSTRUCTIONS

MELSEC-QnA

2.2 How to Read Instruction Tables

The instruction tables in Section 2.3 have the following format.

Table 2.1 How to Read Instruction Tables

Category	Instruction Symbols	Symbol	Processing Details	Execution Condition	Basic Number of Steps	Sub Set	Page
Key input from operation box	INPUT	G.INPUT Un n1 D1 D2 n2	Reads the key input data from the operation box connected to AJ71P32-S3 designated in Un, and stores to word devices starting from the one whose number is designated by (D1). On completion of the processing, the bit device designated in (D2) is turned ON.		10		7-3
		GP.INPUT Un n1 D1 D2 n2					
	PRN	Q.PRN Un n1 S D n2	Outputs the number of points designated in (n1) of the data stored in word devices starting from the one whose number is designated in (S) to the AJ35PTF-R2 designated by (n2) and connected to the AJ71P32-S3 designated by Un. On completion of the processing, the bit device designated in (D) is turned ON		9		7-7
		GP.PRN Un n1 S D n2					

(1)
(2)
(3)
(4)
(5)
(6)
(7)
(8)



Description

- (1)..... Classifies the instructions according to their purpose
- (2)..... Indicates the code used to enter the instruction in a program
- (3)..... Shows symbol displayed in the ladder
- (4)..... Indicates the type of processing that is performed by individual instructions

2. LIST OF SPECIAL FUNCTION MODULE INSTRUCTIONS

MELSEC-QnA

- (5)..... The detailed conditions for the execution of individual instructions are as follows:

Symbol	Execution Condition
	Executed during ON; instruction is executed only while the precondition is ON. If the precondition is OFF, the instruction is not executed, and no processing is conducted.
	Executed once at ON; instruction executed only at leading edge when precondition goes from OFF to ON. Following execution, instruction will not be executed and no processing conducted even if condition remains ON.

- (6)..... Indicates the basic number of steps for individual instructions. See Section 3.3 for a discussion of the number of steps.
- (7)..... The ● mark indicates instructions for which subset processing is possible. See the QnACPU Programming Manual (Common Instructions) for details of the subset processing.
- (8)..... Indicates the page numbers where the individual instructions are discussed.

2. LIST OF SPECIAL FUNCTION MODULE INSTRUCTIONS

MELSEC-QnA

2.3 List of Special Function Module Instructions

(1) AD61(S1) control instructions

Category	Instruction Symbols	Symbol	Processing Details	Execution Condition	Basic Number of Steps	Sub Set	Page
Preset value data setting	PVWR1		Writes preset data designated in (S) to CH.1 of AD61(S1) designated in Un.		7		5-2
	PVWR2		Writes preset data designated in (S) to CH.2 of AD61(S1) designated in Un.		7		5-2
Writing set value data for "higher", "lower", or "coincident" judgments	SVWR1		Writes set value data designated in (S) to CH.1 of AD61(S1) designated in Un.		7		5-4
	SVWR2		Writes set value data designated in (S) to CH.2 of AD61(S2) designated in Un.		7		5-4
Reading present value	PVRD1		Reads present value data from CH.1 of AD61(S1) designated in Un, and stores data in the word device number designated in (D).		7		5-6
	PVRD2		Reads present value data from CH.2 of AD61(S2) designated in Un, and stores data in the word device number designated in (D).		7		5-6

2. LIST OF SPECIAL FUNCTION MODULE INSTRUCTIONS

MELSEC-QnA

(2) AD59(S1) control instructions

Category	Instruction Symbols	Symbol	Processing Details	Execution Condition	Basic Number of Steps	Sub Set	Page
Outputting to printer	PRN		Outputs the number of bytes designated by (n2) of the data stored in the word device number after the one designated in (S) to the printer connected to the AD59(S1) designated in Un. On completion of the output, the bit device designated in (D) is turned ON.		8		6-2
	PR		Outputs the data stored from the word device number after the one designated in (S) to the 00H code to the printer connected to the AD59(S1) designated by Un. On completion of the output, the bit device designated in (D) is turned ON.		8		6-6
Writing /reading data to/from memory card	GET		Reads the data stored in the number of points designated by (n) after the address designated in (S) from the memory card connected to the AD59(S1) designated in Un, and writes the data to word devices starting from the word device number designated by (D).		8		6-10
	PUT		Reads the data stored in the number of points designated in (n) starting from the word device number after the one designated in (S2) and writes it to addresses after that designated by (S1) in the memory card connected to the AD59(S1) designated by Un.		8		6-13

2. LIST OF SPECIAL FUNCTION MODULE INSTRUCTIONS











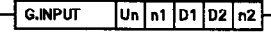

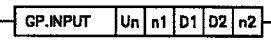

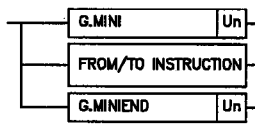

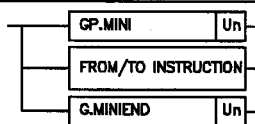

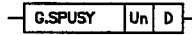

MELSEC-QnA

(3) AJ71P32-S3 MELSECNET/MINIS-3 master module control instructions

Category	Instruction Symbols	Symbol	Processing Details	Execution Condition	Basic Number of Steps	Sub Set	Page
Key input from operation box	INPUT		Reads the key input data from the operation box connected to AJ71P32-S3 designated in Un, and stores to word devices starting from the one whose number is designated by (D1).		10		7-3
			On completion of the processing, the bit device designated in (D2) is turned ON.				
Reading /writing data from/to memory card	PRN		Outputs the number of points designated in (n1) of the data stored in word devices starting from the one whose number is designated in (S) to the AJ35PTF-R2 designated by (n2) and connected to the AJ71P32-S3 designated by Un.		9		7-7
			On completion of the processing, the bit device designated in (D) is turned ON.				
	PR		Outputs the data, up to the 00H code, stored from word device number after the one designated in (S) onward, to the AJ35PTF-R2 designated by (n1) and connected to the AJ71P32-S3 designated by Un.		7		7-11
			On completion of the processing, the bit device designated in (D) is turned ON.				

2. LIST OF SPECIAL FUNCTION MODULE INSTRUCTIONS

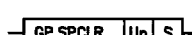
MELSEC-QnA

Category	Instruction Symbols	Symbol	Processing Details	Execution Condition	Basic Number of Steps	Sub Set	Page
Sending /receiving the designated number of bytes of data to/from AJ35PTF-R2	INPUT		Reads, from storage in the J35PT32-R2 designated by Un, data within the number of points designated by (n1) and from a J35PT32-R2, and stores it in word devices from the word device number designated by (D1). On completion of the processing, the bit device designated in (D2) is turned ON.		10		7-15
							
Reading /writing data in MINI default protocol	MINI		Communicates with a remote terminal module which conforms to MINI default protocol and is connected to AJ71PT32-S3 designated in Un.		*5/6		7-21
							
Resetting errors at remote terminal module	MINIERR		Resets remote terminal errors occurring at the AJ71PT32-S3 designated by Un.		7		7-27
							
Reading communication status	SPBUSY		Stores the processing status at the AJ71PT32-S3 designated by Un in the word device number designated by (D).		7		7-28
							
Forced stop of communication processing	SPCLR		Stops the communication processing between the remote terminal module designated by (S) and the AJ71PT32-S3 designated by Un.		7		7-30
							

REMARK

1)*: The MINI instruction has 5 steps and the MINIEND instruction has six steps.

2. LIST OF SPECIAL FUNCTION MODULE INSTRUCTIONS

MELSEC-QnA

(d) AJ71C21(S1) control instructions

Category	Instruction Symbols	Symbol	Processing Details	Execution Condition	Basic Number of Steps	Sub Set	Page
Sending designated number of bytes of data	PRN2		Outputs data corresponding to the number of points designated by (n), stored from the word device whose number is designated by (S) onward, from the RS-232C interface of the AJ71C21(S1) designated by Un, in the no protocol mode. On completion of the processing, the bit device designated in (D) is turned ON.		8		8-2
	PRN4		Outputs data corresponding to the number of points designated by (n), stored from the word device whose number is designated by (S) onward, from the RS-422 interface of the AJ71C21(S1) designated by Un, in the no protocol mode. On completion of the processing, the bit device designated in (D) is turned ON.		8		8-2
Sending data up to 00H	PR2		Outputs data up to the 00H code, stored from the word device whose number is designated by (S), from the RS-232C interface of the AJ71C21(S1) designated by Un in the no protocol mode. On completion of the output, the bit device designated in (D) is turned ON.		7		8-6
	PR4		Outputs data up to the 00H code, stored from the word device whose number is designated by (S), from the RS-422 interface of the AJ71C21(S1) designated by Un, in the no protocol mode. On completion of the output, the bit device designated in (D) is turned ON.		7		8-6

2. LIST OF SPECIAL FUNCTION MODULE INSTRUCTIONS

MELSEC-QnA

Category	Instruction Symbols	Symbol	Processing Details	Execution Condition	Basic Number of Steps	Sub Set	Page
Receiving data	INPUT2		Stores data corresponding to the number of points designated by (n), sent to the RS-232C interface of the AJ71C21(S1) designated by Un in the no protocol mode, in word devices starting from the one whose number is designated by (D1). On completion of the processing, the bit device designated in (D2) is turned ON.		9		8-10
	INPUT4		Stores data corresponding to the number of points designated by (n), sent to the RS-422 interface of the AJ71C21(S1) designated by Un in the no protocol mode, in word devices starting from the one designated in (D1). On completion of the processing, the bit device designated in (D2) is turned ON.		9		8-10
Reading /writing from/to RAM memory	GET		Reads data corresponding to the number of points designated by (n), stored from the address designated by (S) of the RAM memory of the AJ71C21-S1 designated by Un, and stores this data in word devices from the one whose number is designated by (D1). On completion of the processing, the bit device designated in (D2) is turned ON.		9		8-16
	PUT		Reads data corresponding to the number of points designated in (n), stored in word devices starting from the one whose number is designated by (S2), and writes this data to the RAM memory of the AJ71C21-S1 designated in Un, at the addresses from the one designated in (S1). On completion of the processing, the bit device designated in (D2) is turned ON.		9		8-20
Reading communication status	SPBUSY		Stores the processing status of the AJ71C21(S1) designated by Un to the word device number designated in (D).		7		8-24
Forced stop of communication processing	SPCLR		Forcibly Stops the processing of the AJ71C21(S1) designated by Un.		7		8-26

2. LIST OF SPECIAL FUNCTION MODULE INSTRUCTIONS

MELSEC-QnA

(d) Computer link module control instructions

Category	Instruction Symbols	Symbol	Processing Details	Execution Condition	Basic Number of Steps	Sub Set	Page	
Sending data	PRN		Outputs the data corresponding to the number of points designated by (n), stored in word devices starting from the one whose number is designated by (S), from the RS-232C/RS-422 interface of the AJ71C24(S3, S6, S8) /AJ71UC24 designated by Un, in the no protocol mode. On completion of the output, the bit device designated in (D) is turned ON.		8		9-2	
	PR			Outputs, up to the 00H code, data stored in word devices from the one designated by (S), from the RS-232C/RS-422 interface of the AJ71C24(S3, S6, S8)/AJ71UC24 designated by Un, in the no protocol mode. On completion of the output, the bit device designated in (D) is turned ON.		6		9-6
Receiving data	INPUT		Receives the data sent to the RS-232C/RS-422 interface of the AJ71C24(S3, S6, S8)/AJ71UC24 designated by Un, in the no protocol mode, and stores it in the number of points designated by (D2) of word devices starting from the one whose number is designated by (D1). On completion of the processing, the bit device designated in (D) is turned ON.		9		9-10	
Reading communication status	SPBUSY		Stores the send/receive processing status of the AJ71C24(S3, S6, S8) /AJ71UC24 designated by Un to the word device number designated in (D).		7		9-16	
Forced stop	SPCLR		Forcibly stops send/receive processing of the AJ71C24(S3, S6, S8) /AJ71UC24 designated by Un.		7		9-18	

3. CONFIGURATION OF INSTRUCTIONS

This chapter describes the following points of difference between the special function module instructions and the QnACPU common instructions:

- Instruction configuration
- Instruction execution conditions
- Number of Steps

For information on items other than those described here, refer to the QnACPU Programming Manual (Common Instructions)

3.1 Instruction Configuration

Special function module instructions for QnACPU can be divided into a "G. instruction name" part and a device part.

The applications of the instruction part and device part are as follows.

- G.instruction part..... Indicates the function of the instruction.
- Device part..... Indicates the data used for the instruction.

The device part is divided into I/O No., source data, and destination data.

(1) I/O No. (Un)

(a) The I/O No. indicates the location where the special function module is installed.

(b) The upper three digits of the head I/O number of the special function module when expressed as a four-digit hexadecimal number are set for "Un".

For example, if the special function module is allocated to X/Y0120 - X/Y15F, "012" is set for Un.

(2) Source (S)

(a) The "source" is the data used for the operation.

(b) It takes the following forms depending on the devices designated with each instruction.

- Constant..... Designates the numerical values used for the operation.
Since constants are set when the program is created, they cannot be changed during execution of the program.
If a constant is used with variable data, use index qualification.
- Bit device, word device.... Designate the devices in which the data used for the operation is stored.
The data must be stored in the designated device before the operation is executed.
By changing the data stored in a designated device during program execution, the data used with the instruction can be changed.

(3) Destination (D)

(a) The destination stores the data that results from the operation.

(b) It is essential to set a device to store data as the destination.

3.2 Instruction Execution Conditions

There are two types of execution conditions for the special function module instructions for QnACPU.

- Executed while ON..... Instruction executed while the input condition is ON.
Example : G.INPUT instruction, G.PVWR1 instruction
- Executed at leading edge.... Instruction executed only at the leading edge (OFF → ON) of the input condition.
Example : GP.INPUT instruction, GP.PVWR1 instruction

Special function module instructions are available as both "executed while ON" and "executed at leading edge" types.

- Executed while ON instruction G. [Instruction name]
- Executed at leading edge GP. [Instruction name]

In the case of the CMODE instruction, the "executed while ON" and "executed at leading edge" types are designated as follows.

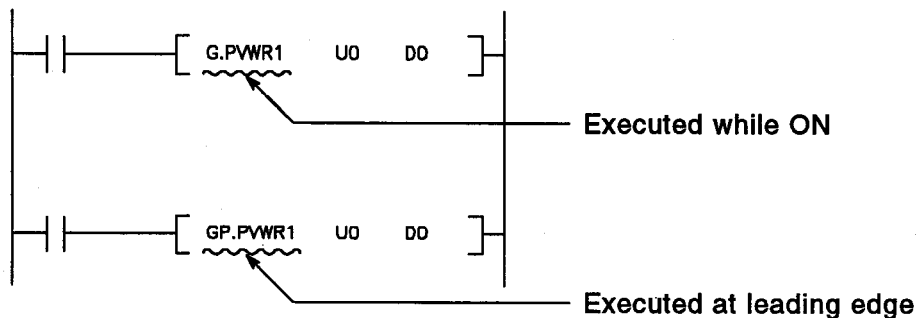

3.3 Number of Steps

The number of steps taken up by special function module instructions for QnACPU depends on the devices used and whether or not indirect designation is used.

The basic numbers of steps for special function module instructions are indicated in the instruction lists in Section 2.3.

- (1) Conditions under which the number of steps is increased
 The number of steps exceeds the basic number of steps if indirect device designation is used or if devices which increase the number of steps are used.

- (a) Indirect designation of devices

If indirect designation is carried out with @ [] , the number of steps is increased by 1 with respect to the basic number of steps.

- (b) Device that increases the number of steps

Device that Increases the Number of Steps	Step Increase
Buffer register	1
Link register	
Consecutive number access file register	
32-bit constant	
Real number constant	
Character string constant	When even : characters numbers/2 When odd : (characters numbers + 1)/2 - 1

- (c) If both conditions (a) and (b) above exist, both steps increase.

4. HOW TO READ EXPLANATIONS FOR INSTRUCTIONS

4 HOW TO READ EXPLANATIONS FOR INSTRUCTIONS

This section describes how to read the detailed explanation of instructions given in Section 5 and later sections.

(1) → **PVWR1, PVWR2** MELSEC-QnA

(2) → **5.1 1mg Preset Value Data**

(3) →

Set data	Usable devices								
	Internal device (system, user)		File register	MELSECNET/10 direct J [N]		Special function module U [JG []	Index register Zn	Constant K, H	Other
	Bit	Word		Bit	Word				
(S)	O							—	

(4) →

(5) →

Set data	Description	Data type
Un	AD61(S1) head I/O number	16-bit binary
(S)	Head device number of devices storing the preset value to be written	32-bit binary

(6) → **Function**

(1)Writes to AD61(S1) the preset value which is stored in the device designated at (S). The preset value writes data directly to the AD61(S1) buffer memory. The channel and buffer memory address for writing the preset value differ according to the instructions used.

Instruction	Write channel	Write buffer memory address
PVWR1	1	1, 2
PVWR2	2	33,34

(2)In the writing of preset values by PVWR1 and PVWR2 instructions, the ON/OFF control of the AD61(S1) preset commands (Y_(S+1), Y_(S+16)) is conducted automatically by internal processing. The user does not need to conduct the ON/OFF control of the preset command.

(3)The preset value designated at (S) and (S)+1 is within the range 0 to 16777215.

6-2

- (1) Instruction symbol
- (2) Section number and general description of the instruction
- (3) " O " indicates the devices that can be used with the instruction. The classes of use into which the devices that can be used are divided are as follows.

Device Classification	Internal Device (System, User)		File Register	MELSECNET/10 Direct J [N]		Special Function Module U [JG []	Index Register Zn	Constant *1	Other *1
	Bit	Word		Bit	Word				
Usable devices	X, Y, M, L, SM, F, V, B, SB, FX, FY *2	T, ST, C, D, W, SD, SW, FD	R, ZR	J [X] J [Y] J [B] J [SB]	J [W] J [SW]	U [G]	Z	Decimal constant Hexadecimal constant Real number constant Character string constant	P, I, J, U, DX, DY, N, BL, TR, BLIS

*1 : The devices that can be set are indicated in the "Constant" and "Other" columns.
 *2 : FX and FY can only be used with bit data, and FD can only be used with word data.

4. HOW TO READ EXPLANATIONS FOR INSTRUCTIONS

MELSEC-QnA

PVWR1, PVWR2

MELSEC-QnA

Operation Errors

- (1) In the following cases an operation error occurs, the error flag (SM0) turns ON, and the error code is stored in SD0.
- * When the module attempting access is not a special function module. (Error code: 2110)
 - * When dedicated instructions cannot be used for the designated module. (Error code: 2112)
 - * When the designated instruction name is illegal. (Error code: 4300)
 - * When the number of AD61(S1) control instruction devices is illegal. (Error code: 4301)
 - * When a non-designatable device is designated. (Error code: 4302)

(7)

Program Example

- (1) The following is an example program which, when X0 is ON, writes the preset data of D0 and D1 to the buffer memory for channel 1 of the AD61 installed at I/O numbers X/Y020 to X/Y03F.

(8)

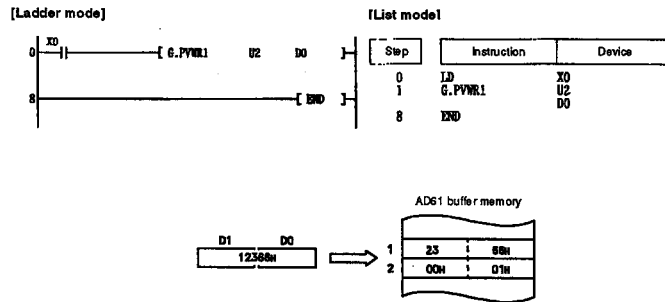

5-8

- (4) Indicates the expressions and instruction execution conditions in the ladder mode.

Execution Condition	Executed while ON	Executed Once at OFF to ON
Symbol used on the explanation page		

- (5) Explains the set data for each instruction and indicates the data type.

Data Type	Description
Bit	Indicates that bit data or the first number of bit data can be used.
16-bit binary	Indicates that binary 16-bit data or the first number of word devices can be used.
32-bit binary	Indicates that binary 32-bit data or the first number of double-word devices can be used.
Character string	Indicates that character string data can be used.
Device name	Indicates that device names can be used.

- (6) Indicates the function of the instruction.
(7) Indicates the conditions that will cause errors and the error numbers.
(8) A simple program example in both ladder and list formats is given here. The contents of each device when the program is executed are also indicated.

5. AD61(S1) CONTROL INSTRUCTIONS

AD61(S1) control instructions are instructions for writing and reading data to an AD61(S1).

The following table shows AD61(S1) control instructions.

Category	Instruction Name	Description	Refer to
Writing preset data	PVWR1	Writes channel 1 preset data to buffer memory addresses 1 and 2.	Section 5.1
	PVWR2	Writes channel 2 preset data to buffer memory addresses 33 and 34.	
Writing set value data	SVWR1	Writes channel 1 set value data to buffer memory addresses 6 and 7.	Section 5.2
	SVWR2	Writes channel 2 set value data to buffer memory addresses 38 and 39.	
Reading present value	PVRD1	Reads channel 1 present value (count input value) to buffer memory addresses 4 and 5.	Section 5.3
	PVRD2	Reads channel 2 present value (count input value) to buffer memory addresses 36 and 37.	

POINT

When the module model name is not registered in the parameter settings, no error occurs even if AD61(S1) control instructions are executed with respect to an AJ71C21(S1).

However, note that when AD61(S1) control instructions are executed with respect to an AJ71C21(S1), the AJ71C21(S1) may not operate normally.

5.1 Setting Preset Value Data

Set Data	Usable Devices								
	Internal Device (System, User)		File Register	MELSECNET/10 Direct I/O		Special Function Module U/D/G	Index Register Zn	Constant K,H	Other
	Bit	Word		Bit	Word				
(S)								—	

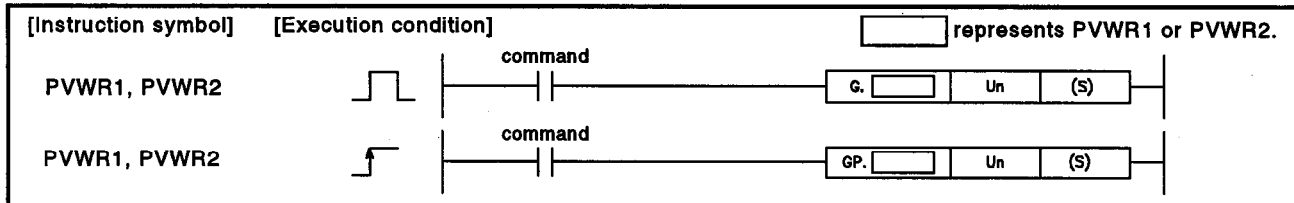

Set Data

Set Data	Description	Data Type
Un	AD61(S1) head I/O number	16-bit binary
(S)	Head device number of devices storing the preset value to be written	32-bit binary

Function

- Writes to AD61(S1) the preset value which is stored in the device designated at (S).
The preset value writes data directly to the AD61(S1) buffer memory. The channel and buffer memory address for writing the preset value differ according to the instructions used.

Instruction	Write Channel	Write Buffer Memory Address
PVWR1	1	1, 2
PVWR2	2	33,34

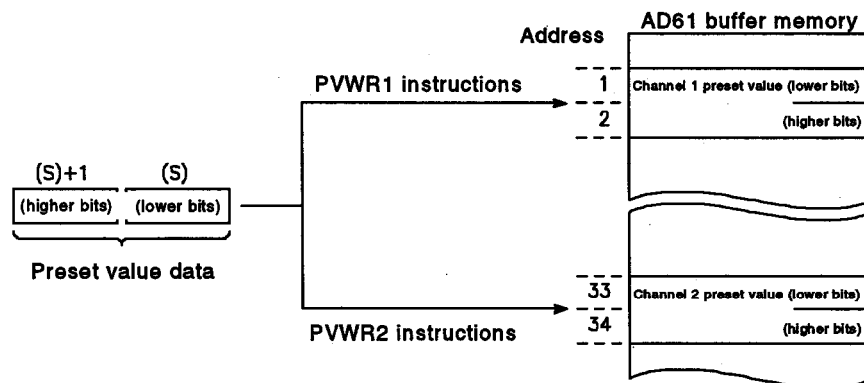

- In the writing of preset values by PVWR1 and PVWR2 instructions, the ON/OFF control of the AD61(S1) preset commands (Y(n+11), Y(n+18)) is conducted automatically by internal processing. The user does not need to conduct the ON/OFF control of the preset command.
- The preset value designated at (S) and (S)+1 is within the range 0 to 16777215.

Operation Errors

- (1) In the following cases an operation error occurs, the error flag (SM0) turns ON, and the error code is stored in SD0.
- When the module attempting access is not a special function module. (Error code: 2110)
 - When dedicated instructions cannot be used for the designated module. (Error code: 2112)
 - When the designated instruction name is illegal. (Error code: 4300)
 - When the number of AD61(S1) control instruction devices is illegal. (Error code: 4301)
 - When a non-designatable device is designated. (Error code: 4302)

Program Example

- (1) The following is an example program which, when X0 is ON, writes the preset data of D0 and D1 to the buffer memory for channel 1 of the AD61 installed at I/O numbers X/Y020 to X/Y03F.

[Ladder mode]

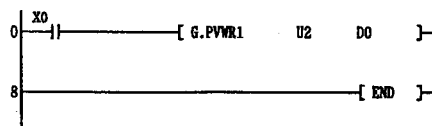

[List mode]

Step	Instruction	Device
0	LD	X0
1	G.PVWR1	U2 D0
8	END	

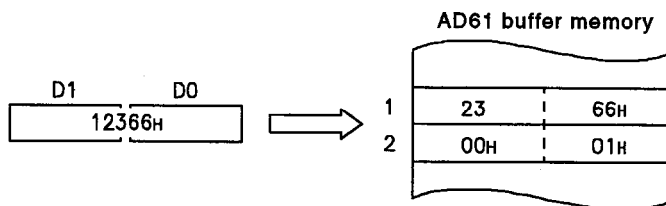

5.2 Setting Set Value Data for Greater/Smaller/Equal Judgments

Set Data	Usable Devices								
	Internal Device (System, User)		File Register	MELSECNET/10 Direct I/O		Special Function Module Usage	Index Register Zn	Constant K,H	Other
	Bit	Word		Bit	Word				
(S)	O							—	

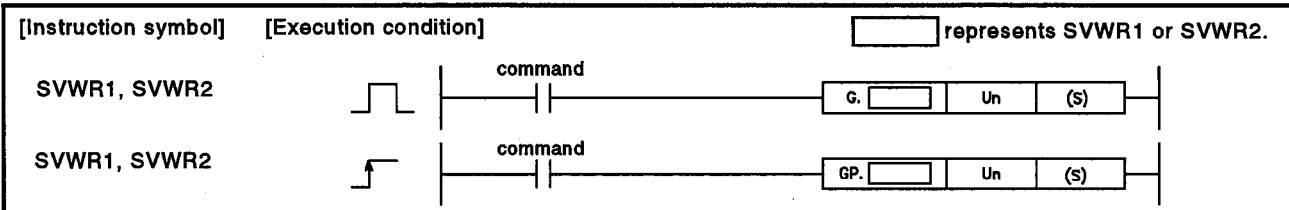

Set Data

Set Data	Description	Data Type
Un	AD61(S1) head I/O number	16-bit binary
(S)	Head device number of devices storing the preset value to be written	32-bit binary

Function

- Writes to AD61(S1) the set value which is stored in the device designated at (S).
 This set value is a standard value against which the present count is compared to judge whether it is greater, smaller, or equal to it. The set value writes data directly to the AD61(S1) buffer memory. The channel and buffer memory address for writing the set value differ according to the instructions used.

Instruction	Write Channel	Write Buffer Memory Address
SVWR1	1	6, 7
SVWR2	2	38, 39

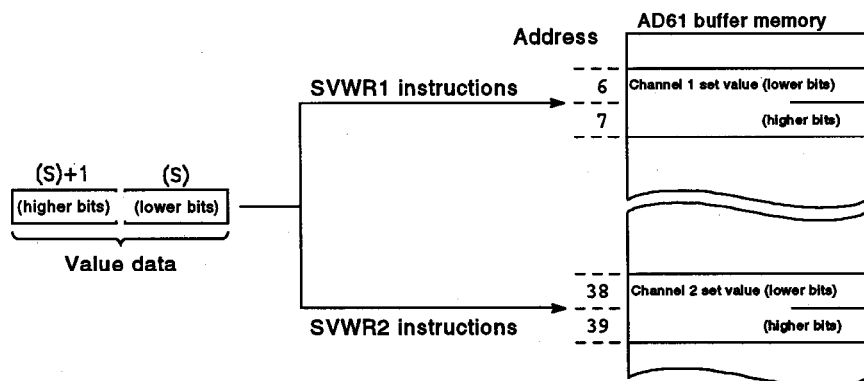

- In the writing of set values by SVWR1 and SVWR2 instructions, the ON/OFF control of the AD61(S1) match signal reset commands ($Y_{(n+10)}$, $Y_{(n+17)}$) and match signal output enable ($Y_{(n+12)}$, $Y_{(n+19)}$) are conducted automatically by internal processing. The user does not need to conduct the ON/OFF control of the match signal reset command and enable signal output enable.
- The preset value designated at (S) and (S)+1 is within the range 0 to 16777215.

Operation Errors

- (1) In the following cases an operation error occurs, the error flag (SM0) turns ON, and the error code is stored in SD0.
- When the module attempting access is not a special function module. (Error code: 2110)
 - When AD61(S1) control instructions cannot be used for the designated module. (Error code: 2112)
 - When the designated instruction name is illegal. (Error code: 4300)
 - When the number of AD61(S1) control instruction devices is illegal. (Error code: 4301)
 - When a non-designatable device is designated. (Error code: 4302)

Program Example

- (1) The following is an example program which, when X0 is turned ON, writes D0 and D1 set data to the buffer memory for channel 1 of the AD61 installed at I/O numbers X/Y020 to X/Y03F.

[Ladder mode]

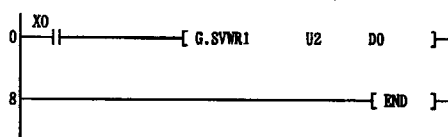

[List mode]

Step	Instruction	Device
0	LD	X0
1	G.SVWR1	U2 D0
8	END	

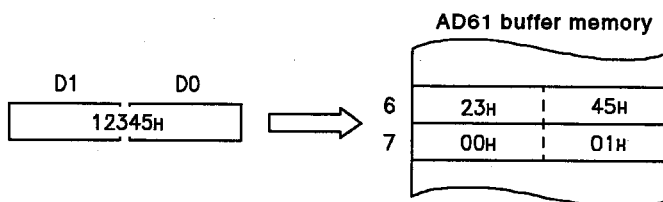

5.3 Reading Present Value

Set Data	Usable Devices								
	Internal Device (System, User)		File Register	MELSECNET/10 Direct J[...]		Special Function Module U[...]	Index Register Zn	Constant	Other
	Bit	Word		Bit	Word				
(D)	O							—	

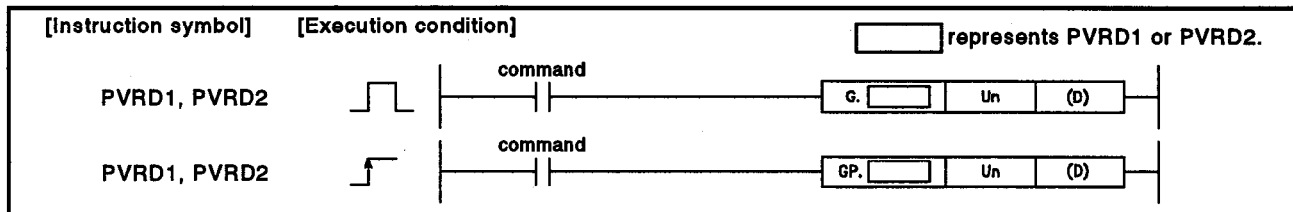

Set Data

Set Data	Description	Data Type
Un	AD61(S1) head I/O number	16-bit binary
(D)	Head device number of devices to store the read present value	32-bit binary

Function

- (1) Reads present value from AD61(S1), and stores in the device designated at (D).
 In present value reading, data is read directly from the AD61(S1) buffer memory.
 The channel and buffer memory address for reading the present value differ according to the instructions used.

Instruction	Read Channel	Read Buffer Memory Address
PVRD1	1	4, 5
PVRD2	2	36, 37

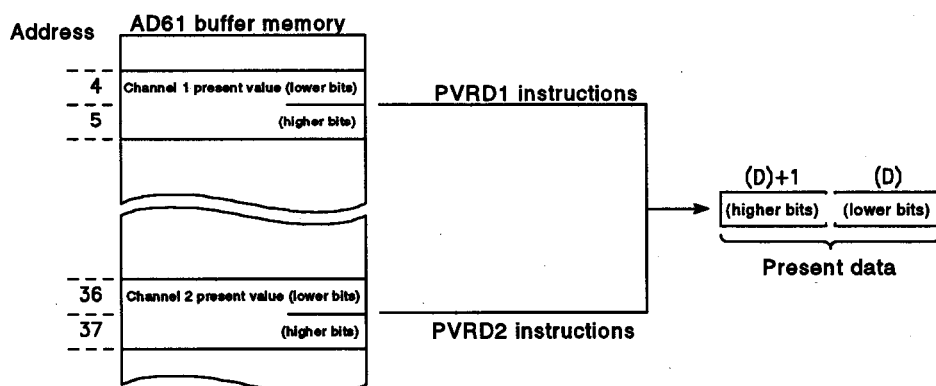

- (2) In the reading of present values by PVRD1 and PVRD2 instructions, the ON/OFF control of the AD61(S1) present value read requests (Y_(n+15), Y_(n+1c)) is conducted automatically by internal processing.
 The user does not need to conduct the ON/OFF control of the present value read request.

Operation Errors

- (1) In the following cases an operation error occurs, the error flag (SM0) turns ON, and the error code is stored in SD0.
 - When the module attempting access is not a special function module. (Error code: 2110)
 - When AD61(S1) control instructions cannot be used for the designated module. (Error code: 2112)
 - When the designated instruction name is illegal. (Error code: 4300)
 - When the number of AD61(S1) control instruction devices is illegal. (Error code: 4301)
 - When a non-designatable device is designated. (Error code: 4302)

Program Example

- (1) The following is an example program which, when X0 is turned ON, reads present values for channel 1 of the AD61 installed at I/O numbers X/Y020 to X/Y03F to D0 and D1.

[Ladder mode]

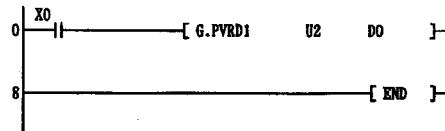

[List mode]

Step	Instruction	Device
0	LD	X0
1	G.PVRD1	U2 D0
8	END	

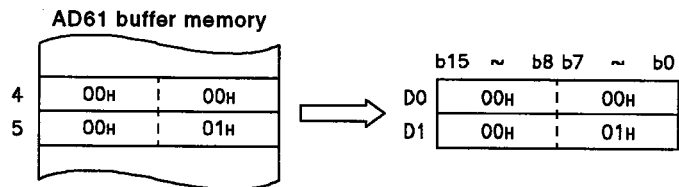

6. AD59(S1) CONTROL INSTRUCTIONS

AD59(S1) control instructions are instructions for reading and writing data to memory cards installed in an AD59(S1), and for sending data to connected printers.

The following table shows the AD59(S1) control instructions.

Category	Instruction Name	Description	Refer to
Send character data to printer	PRN	Sends designated number of character data to connected printer.	Section 6.1
	PR	Sends character data up to 00H code to connected printer.	Section 6.2
Reading /writing to memory card	GET	Reads data from installed memory card.	Section 6.3
	PUT	Writes data to installed memory card.	Section 6.4

POINTS

- (1) When sending character data to the printer for the AD59(S1), the initial setting does not need to be made in the user program because the initial setting for the AD59(S1) is automatically conducted when the PC CPU is set to RUN.
- (2) In the initial setting for the AD59(S1), set output to the printer in byte units.
Do not change this setting to word units in the user program.
If the user changes the printer output unit from byte to word units, it may not be possible to output normal data to the printer when executing PRN and PR instructions.

6.1 Sending to the Printer any Number of Character Data

Set Data	Usable Devices									
	Internal Device (System, User)		File Register	MELSECNET/10 Direct I/O		Special Function Module I/O	Index Register Zn	Constant		Other
	Bit	Word		Bit	Word			K, H	\$	
n	○	○			○			○	—	—
(S)	—	○			—			○	○	—
(D)	○	○			—			—	—	—

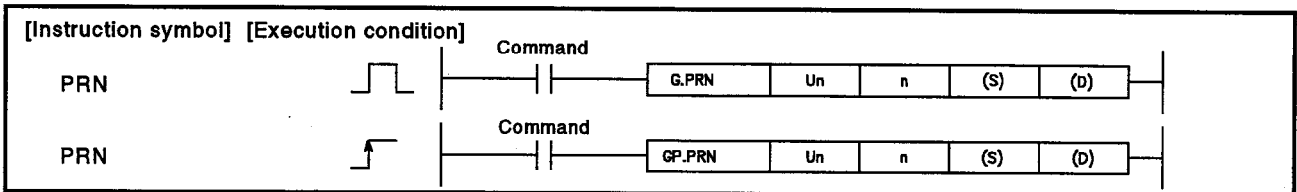

Set Data

Set Data	Description	Data Type
Un	AD59(S1) head I/O number	16-bit binary
n	Number of characters to be output (no. of bytes)	
(S)	First number of device storing characters to be output	Character string
(D)	Number of the bit device turning ON at execution completion	Bit

Function

- (1) Sends to the printer connected to AD59(S1) n number of characters (no. of bytes) stored from the device number designated at (S) onwards. When output processing is completed, the bit device designated at (D) automatically turns ON after only 1 scan.

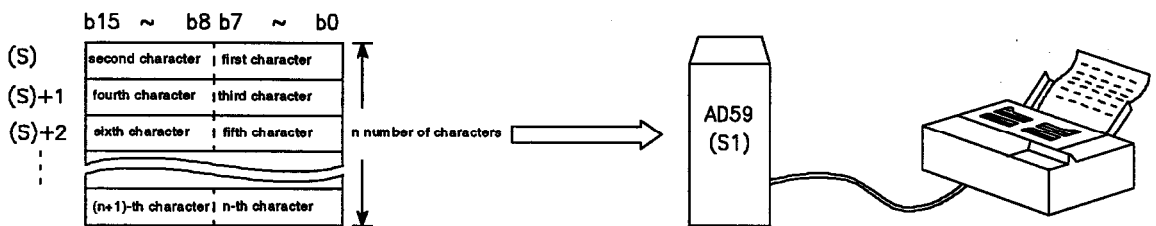

The situation when the characters "ABCDE" stored in D200 to D202 are sent to the printer is shown below.

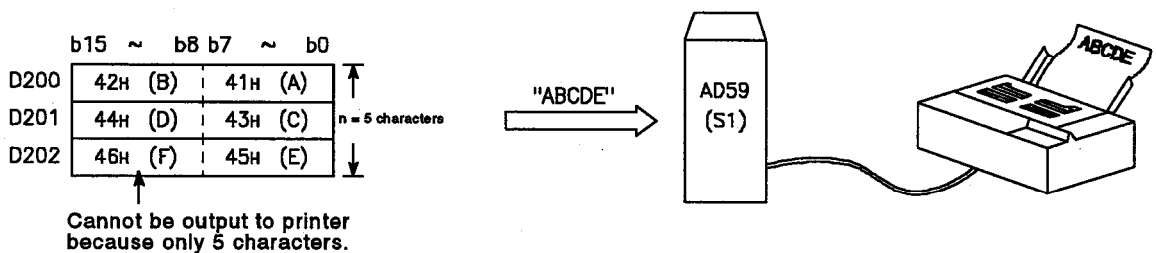

- (2) AD59(S1) initial setting takes place automatically during CPU RUN.
- (3) The number of characters (no. of bytes) that can be designated at n is 1 to 1024.
- (4) Character data stored from the device number designated at (S) and onwards is set using ASCII codes 00H to FFH.
- (5) The bit device designated at (D) automatically turns ON on execution of the END instruction of the scan completing the character output processing, and turns OFF at the END instruction of the next scan. Processed as a PRN instruction execution completed flag.
- (6) Processing of output to the printer by PRN instructions is conducted in byte units.
Character data stored from the device number designated at (S) onwards is automatically rearranged so that it can be processed in byte units.
- (7) PRN instructions can only be executed when AD59(S1) X_(n+4) (FIFO memory empty) is ON.
If PRN instructions are run when X_(n+4) is OFF, no processing is performed.
(The bit device designated at (D) will also not turn ON).

Operation Errors

- (1) In the following cases an operation error occurs, the error flag (SM0) turns ON, and the error code is stored in SD0.
 - When the number of characters (no. of bytes) designated at n is outside the range 1 to 1024. (Error code: 4100)
 - When from the device number designated at (S) onwards, the range of the number of characters designated at n exceeds the last device number of the applicable device. (Error code: 4101)
 - When the character data stored from the device number designated at (S) onwards is less than n-characters. (Error code: 4100)
 - When the module attempting access is not a special function module. (Error code: 2110)
 - When AD59(S1) control instructions cannot be used for the designated module. (Error code: 2112)
 - When the designated instruction name is illegal. (Error code: 4300)
 - When the number of AD59(S1) control instruction devices is illegal. (Error code: 4301)
 - When a non-designatable device is designated. (Error code: 4302)

Program Example

- (1) The following is an example program which, when X0 turns ON, outputs decimal values stored in D10 as characters to a printer connected to AD59 installed at I/O numbers X/Y080 to X/Y09F. M1 turns ON on completion of execution of the instructions.

[Ladder mode]

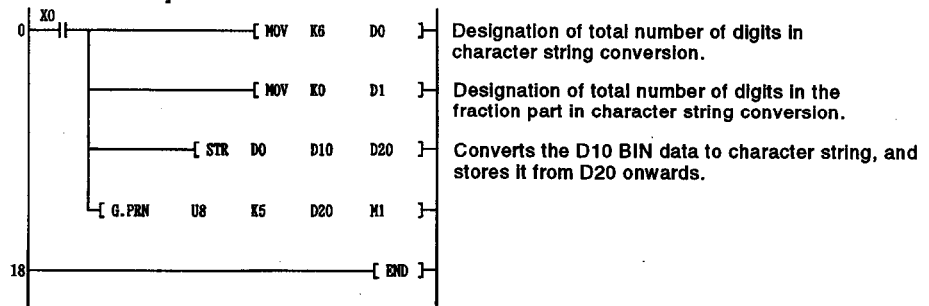

[List mode]

Step	Instruction	Device
0	LD	X0
1	MOV	K6 D0
3	MOV	K0 D1
5	STR	D0 D10 D20
9	G.PRN	U8 K5 D20 M1
18	END	

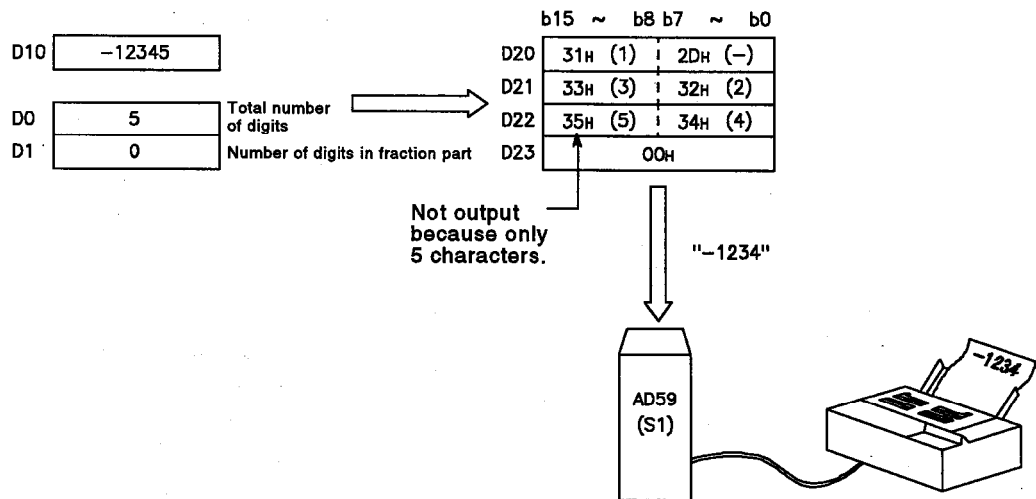

6.2 Sending to the Printer Characters up to "00H" Code

Set Data	Usable Devices								
	Internal Device (System, User)		File Register	MELSECNET/10 Direct I/O		Special Function Module USER	Index Register Zn	Constant \$	Other
	Bit	Word		Bit	Word				
(S)	○	○					○	—	
(D)	—	○					—	—	

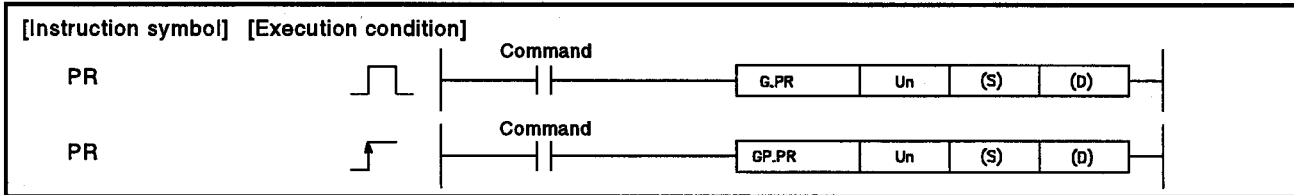

Set Data

Set Data	Description	Data Type
Un	AD59(S1) head I/O number	16-bit binary
(S)	First number of device storing characters to be output	Character string
(D)	Number of the bit device turning ON at execution completion	Bit

Function

- (1) Sends to the printer connected to AD59(S1) characters from the device number designated in (S) to the number of the device storing "00H". When output processing is completed, the bit device designated at (D) automatically turns ON after only 1 scan.

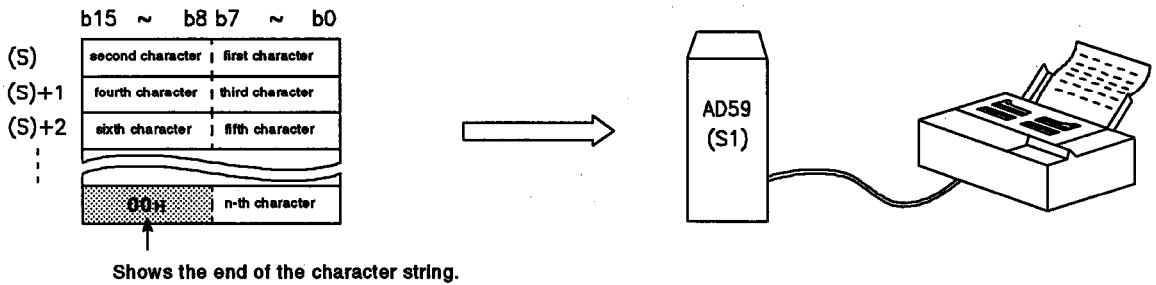

The situation when the characters "ABCDE" stored in D200 to D202 are sent to the printer is shown below.

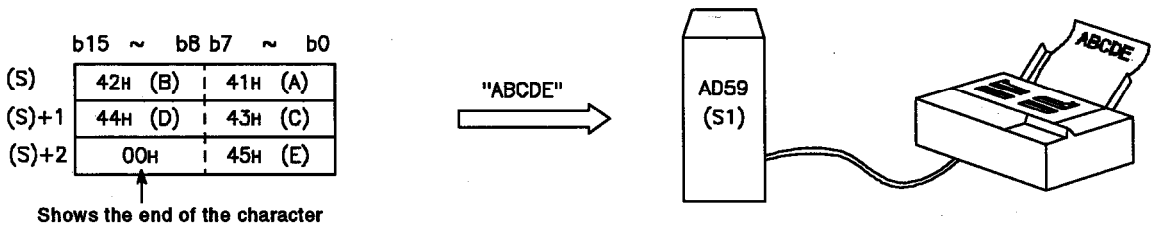

- (2) AD59(S1) initial setting takes place automatically during CPU RUN.
- (3) Character data stored from the device number designated at (S) and onwards is set using ASCII codes 00H to FFH.
- (4) The maximum number of characters that can be output at one time is 1024 characters.
- (5) The bit device designated at (D) automatically turns ON on execution of the END instruction of the scan completing the character output processing, and turns OFF at the END instruction of the next scan. It is processed as a PR instruction execution completion flag.
- (6) Processing of output to the printer by PR instructions is conducted in byte units.
Character data stored from the device number designated at (S) onwards is automatically rearranged so that it can be processed in byte units.
- (7) PR instructions can only be executed when AD59(S1) X_(n+4) (FIFO memory empty) is ON.
If PR instructions are executed when X_(n+4) is OFF, there is no operation. (The bit device designated at (D) will also not turn ON).

Operation Errors

- (1) In the following cases an operation error occurs, the error flag (SM0) turns ON, and the error code is stored in SD0.
 - When the output number of characters exceeds 1024, or when there are 0 characters. (Error code: 4100)
 - When "00H" is not stored between the first and last number of the device designated at (S). (Error code: 4100)
 - When the module attempting access is not a special function module. (Error code: 2110)
 - When AD59(S1) control instructions cannot be used for the designated module. (Error code: 2112)
 - When the designated instruction name is illegal. (Error code: 4300)
 - When the number of AD59(S1) control instruction devices is illegal. (Error code: 4301)
 - When a non-designatable device is designated. (Error code: 4302)

Program Example

- (1) The following is an example program which, when X0 turns ON, outputs decimal values stored in D10 as characters to a printer connected to AD59 installed at I/O numbers X/Y080 to X/Y09F. M1 turns ON on completion of execution of the instructions.

[Ladder mode]

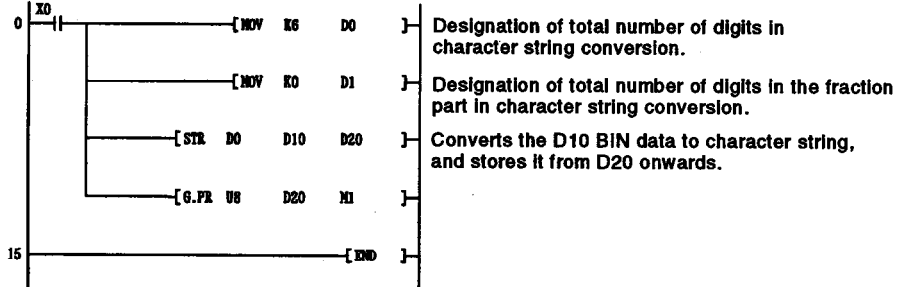

[List mode]

Step	Instruction	Device
0	LD	X0
1	MOV	K6 D0
3	MOV	K0 D1
5	STR	D0 D10 D20
9	G.PR	U8 D20 M1
15	END	

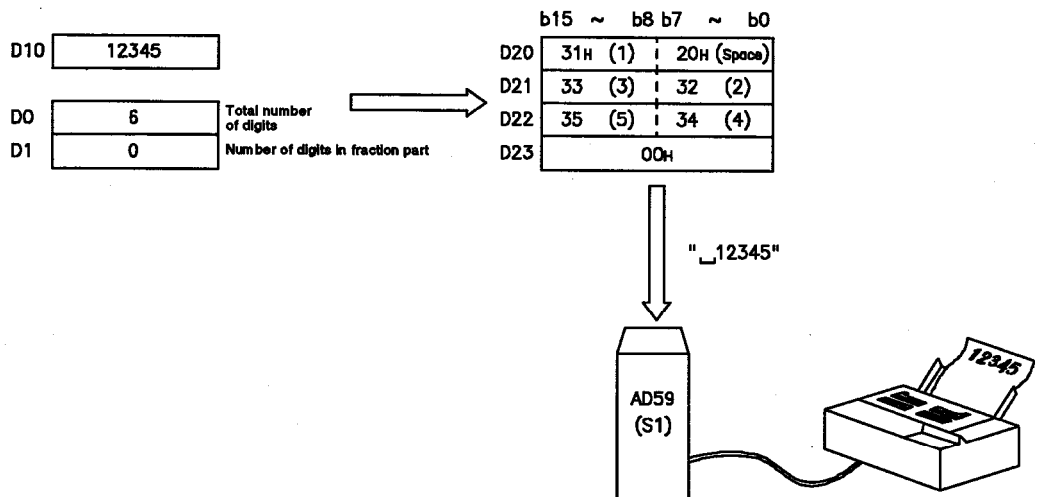

6.3 Reading Data from Memory Card

Set Data	Usable Devices								
	Internal Device (System, User)		File Register	MELSECNET/10 Direct JUNCTION		Special Function Module USAGE	Index Register Zn	Constant K, H	Other
	Bit	Word		Bit	Word				
(S)	—	○						—	
(n)	○	○				○		—	
(D)	—	○						—	

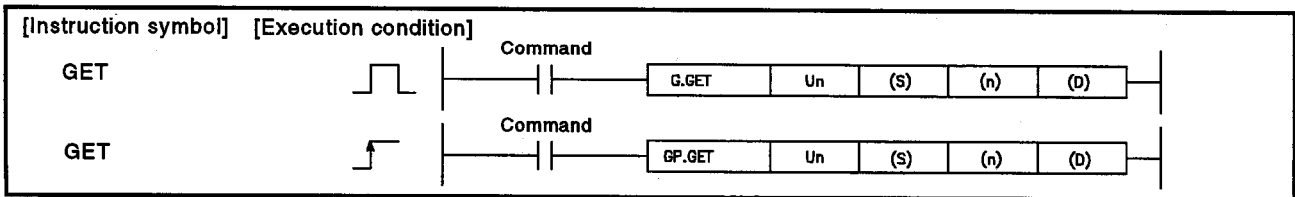

Set Data

Set Data	Description	Data Type
Un	AD59(S1) head I/O number	16-bit binary
(S)	First address number of the memory card storing the data to be read	
(n)	Number of words of data to be read	
(D)	First number of device storing data to be read	Device name

Function

- (1) Reads (n) words of data from the address number designated at (S) of the memory card installed in AD59(S1), and stores it from the device number designated at (D) onwards.

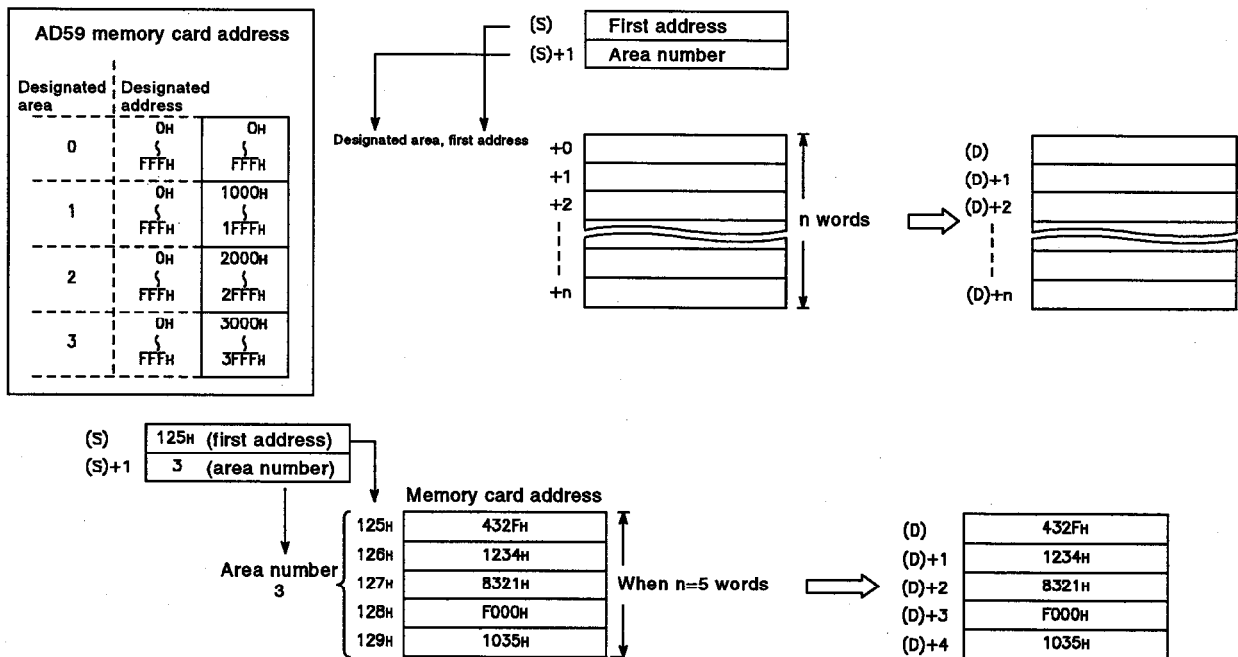

- (2) In reading the memory card data by GET instructions, area switching by the AD59(S1) I/O signal $Y_{(n+10)}$, $Y_{(n+11)}$ ON/OFF control is conducted automatically by internal processing, and so the user does not need to conduct area switching.
- (3) The first address number designated at (S) is within the range "0 to FFFH".
- (4) The area number designated at (S)+1 is within the range "0 to 3".
- (5) The number of words designated at (n) is within the range "1 to 4096". However, reading from multiple areas is not possible.

Operation Errors

- (1) In the following cases an operation error occurs, the error flag (SM0) turns ON, and the error code is stored in SD0.
 - When the first address number designated at (S) exceeds the range "0 to FFFH". (Error code: 4100)
 - When the area number used at (S)+1 exceeds the range "0 to 3". (Error code: 4100)
 - When the number of words designated at (S) exceeds the range "1 to 4096". (Error code: 4100)
 - When the range of number of words designated at (n) from first address number designated at (S) exceeds the FFFH address. (Error code: 4100)
 - When the range of number of words designated at (n) from the device number designated at (D) exceeds the last device number of the applicable device. (Error code: 4101)
 - When the module attempting access is not a special function module. (Error code: 2110)
 - When AD59(S1) control instructions cannot be used for the designated module. (Error code: 2112)
 - When the designated instruction name is illegal. (Error code: 4300)
 - When the number of AD59(S1) control instruction devices is illegal. (Error code: 4301)
 - When a non-designatable device is designated. (Error code: 4302)

Program Example

- (1) The following is an example program which, when X0 turns ON, stores data from addresses 0H to D4H of memory card area number 1 of the AD59 installed at I/O numbers X/Y020 to X/Y03F, to D0 to D4.

[Ladder mode]

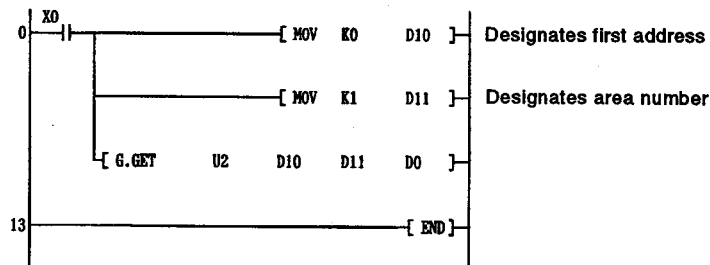

[List mode]

Step	Instruction	Device
0	LD	X0
1	MOV	K6
		D0
3	MOV	K0
		D1
5	STR	D0
		D10
		D20
9	G.PR	U8
		D20
		M1
15	END	

D10	0	(first address)
D11	1	(area number)

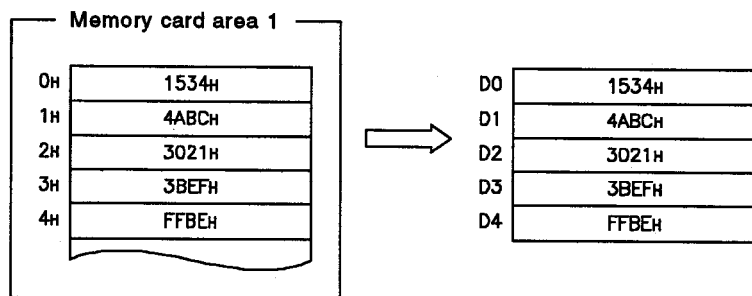

6.4 Writing Data to a Memory Card

Set Data	Usable Devices								
	Internal Device (System, User)		File Register	MELSECNET/10 Direct I/O		Special Function Module I/O	Index Register Zn	Constant K, H	Other
	Bit	Word		Bit	Word				
(S1)	○	○			○			—	
n	○	○			○			—	
(S2)	—	○			—			—	

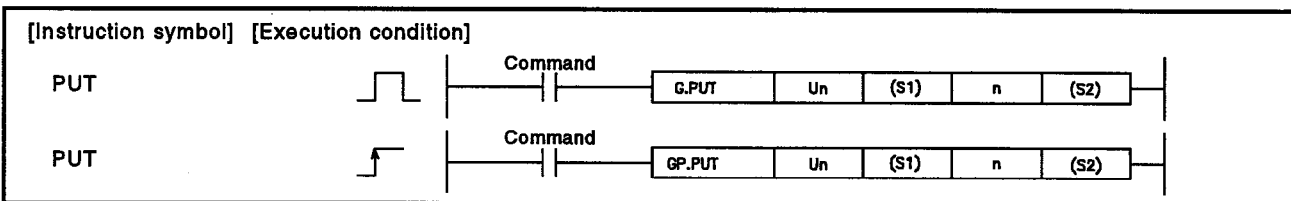

Set Data

Set Data	Description	Data Type
Un	AD59(S1) head I/O number	16-bit binary
(S1)	First address number of the memory card to store the written data	
n	Number of words of data written	
(S2)	First device number of devices storing the written data	Device name

Function

- (1) Writes n words of data stored from the device number designated by (S2) onward to address numbers starting with that designated by (S1) of the memory card installed in the AD59(S1).

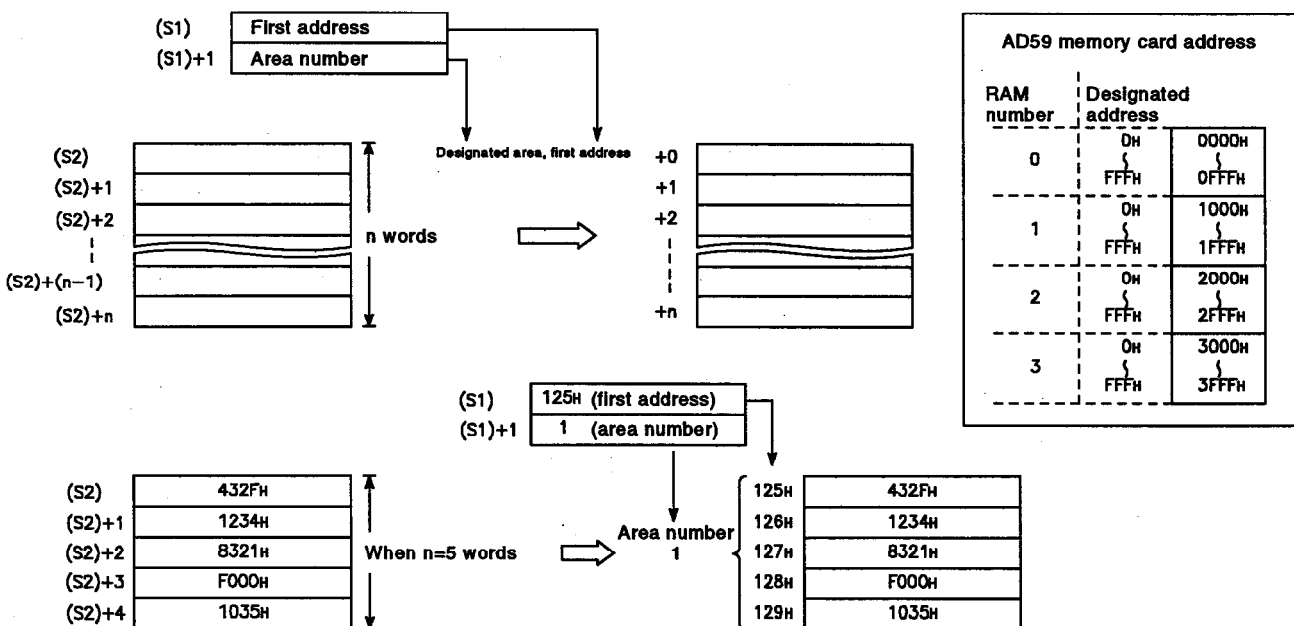

- (2) Since, when data is written to a memory card using the PUT instruction, area switching is performed automatically in internal processing in accordance with the ON/OFF control of AD59(S1) I/O signals $Y_{(n+10)}$, $Y_{(n+11)}$, the user does not have to perform area switching.
- (3) The first address number designated at (S) is within the range "0 to FFFH".
- (4) The area number designated at (S)+1 is within the range "0 to 3".
- (5) The number of words designated at n is within the range "1 to 4096".
Note that it is not possible to write data to a destination that overlaps two or different area more areas.

Operation Errors

- (1) In the following cases an operation error occurs, the error flag (SM0) turns ON, and the error code is stored in SD0.
 - The address number designated by (S1) exceeds the range 0 to FFFH.
(Error code: 4100)
 - The area number designated by (S1) + 1 exceeds the range 0 to 3.
(Error code: 4100)
 - When the number of words designated at n exceeds the range 1 to 4096
(Error code: 4100)
 - When the range of number of words designated at (n) from first address number designated at (s) exceeds the FFFH address.
(Error code: 4100)
 - The range of the number of words designated by n, from the first device number designated by (S2), exceeds the final device number of the relevant device.
(Error code: 4101)
 - When the module attempting access is not a special function module.
(Error code: 2110)
 - When AD59(S1) control instructions cannot be used for the designated module.
(Error code: 2112)
 - When the designated instruction name is illegal. (Error code: 4300)
 - When the number of AD59(S1) control instruction devices is illegal.
(Error code: 4301)
 - When a non-designatable device is designated. (Error code: 4302)

Program Example

- (1) A program which, when X0 turns ON, writes the data of D0 to D4 to addresses 0H to 4H of area number 1 of the AD59 memory card is shown here.

[Ladder mode]

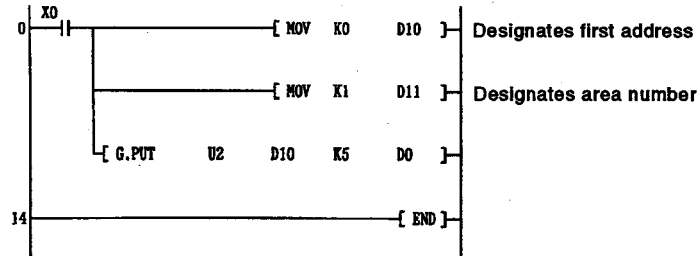

[List mode]

Step	Instruction	Device
0	LD	X0
1	MOV	K0 D10
3	MOV	K1 D11
5	G.PUT	U2 D10 K5 D0
14	END	

D10	0	(first address)
D11	1	(area number)

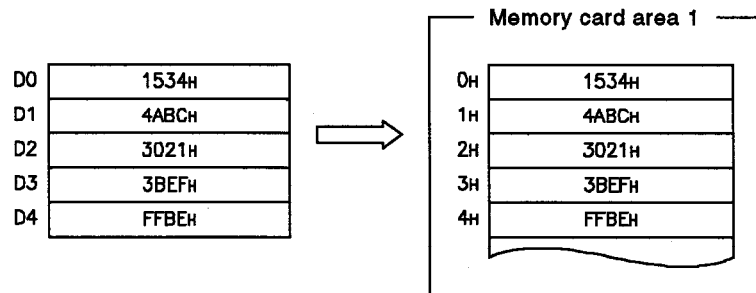

7. AJ71PT32-S3 CONTROL INSTRUCTIONS

AJ71PT32-S3 control instructions are instructions for conducting data communications with remote terminal modules connected to a MELSEC-NET/MINI-S3 data link system.

The following table shows the AJ71PT32-S3 control instructions.

Category	Instruction Name	Description	Refer to
Key input from operation box	INPUT	Reads keyed-in data from AJ35PT-OPB-M1/AJ35T-OPB-P1 operation boxes.	Section 7.1
Data send to AJ35PTF-R2	PRN	Transmits designated number of data to external device connected to AJ35PTF-R2 RS-232C interface module.	Section 7.2
	PR	Transmits all data up to 00H code to external device connected to AJ35PTF-R2 RS-232C interface module.	Section 7.3
Data receive from AJ35PTF-R2	INPUT	Reads data received from external device connected to AJ35PTF-R2 RS-232C interface module.	Section 7.4
Communication with devices conforming to MINI standard protocol	MINI	Conducts data communications with remote terminal module conforming to MINI standard protocol.	Section 7.5
Error reset	MINIERR	Resets error-detected status for remote terminal modules of the AJ71PT32-S3 master module.	Section 7.6
Reading communication processing status	SPBUSY	Reads status of communication processing with the remote terminal module by instructions.	Section 7.7
Forced stop of communication processing	SPCLR	Forcibly stops communication processing with remote terminal modules.	Section 7.8

POINTS

- (1) AJ71PT32-S3 control instructions can only be executed with respect to an AJ71PT32-S3 set in the extension mode.
If the instructions are executed with an AJ71PT32-S3, or AJ71PT32 set in the I/O dedicated mode, an error occurs and no processing takes place.
- (2) An initial data ROM must be installed in an AJ71PT32-S3 used with AJ71PT32-S3 control instructions.
An AJ71PT32-S3 cannot be controlled if the initial data ROM is not installed.
Furthermore, a message ROM must also be installed if an AJ35PT-OPB-M1/AJ35-OPB-P1 operation box is used.
See the SW0SGP-MINIP Operating Manual for details about creating the initial ROM and message ROM.
- (3) In communications between AJ71PT32-S3 and AJ71PT32 and batch refresh type remote I/O modules, a program can be created without worrying about the buffer memory address by setting automatic refresh in the parameter settings.
When automatic refresh setting is performed, the batch refresh communication data buffer memory is communicated automatically with AJ71PT32-S3 or AJ71PT32.
Accordingly, it is possible to communicate with a batch refresh type remote I/O module using a device allocated to the communication data storage device.
(See the QnACPU User's Manual for details.)
- (4) When conducting communications between AJ71PT32-S3 and remote terminal modules with AJ71PT32-S3 control instructions, before executing the instructions the AJ71PT32-S3 communications start signal ($Y_{(n+28)}$) must be turned ON by the sequence program. If the instructions are executed while the communications start signal is OFF, the instructions enter the waiting-for-processing status, and processing of the instructions is not completed.
When communications start signal ($Y_{(n+28)}$) turns ON in the waiting-for-processing status, the instruction processing is executed.
However, when automatic refresh setting is set, the communications start signal ($Y_{(n+28)}$) is automatically turned ON when the CPU is switched from STOP to RUN.
- (5) Up to 8 AJ71PT32-S3s can be automatically refreshed by the QnACPU.
To use 9 or more AJ71PT32-S3s, use the "FROM" and "TO" instructions to exercise control from the user program.

7.1 Key Input from Operation Box

Set Data	Usable Devices								
	Internal Device (System, User)		File Register	MELSECNET/10 Direct I/O		Special Function Module USAGE	Index Register Zn	Constant K, H	Other
	Bit	Word		Bit	Word				
n1	—	O						—	
(D1)	—	O						—	
(D2)	O	O						—	
n2	O	O				O		—	

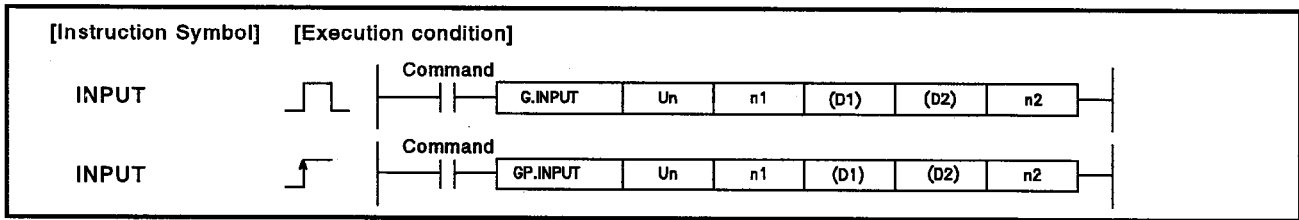

Set Data

Set Data	Description	Data Type
Un	AJ71PT32-S3 head I/O number	16-bit binary
n1	Permissible number of received data, and number of received data (word units)	
(D1)	First number of device storing key operation status	Device name
(D2)	Number of the bit device turning ON on completion of processing	Bit
n2	Remote terminal number of applicable operation box	16-bit binary

Function

- Out of the operation boxes connected to AJ71PT32-S3, fetches the key operation status from the operation box corresponding to the remote terminal number designated at n2, and stores it from the device number designated at (D1) onwards. When the fetching and processing of the key operation status is completed, the bit device designated at (D2) is automatically turned ON after only 1 scan.

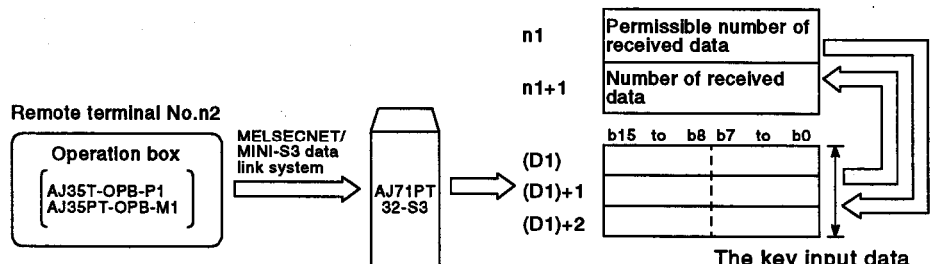

- Sets permissible number of received data to "3 and above".
- "3" stored for number of received data.

The key input data of the operation box stored in 3 words. See (3).

POINTS

- (1) G(P).INPUT cannot be made into a pulse signal.
- (2) Execute G(P).INPUT when I/O signal read request is ON.

- (2) In receive processing by INPUT instructions, the reading of data received in the AJ71PT32-S3 buffer memory, and I/O signal read request and read completed ON/OFF processing, is conducted automatically by internal processing, so the user does not need to conduct ON/OFF control of the I/O signals.
- (3) As shown below, in the key-input data from the operation box, the status of each key in the operation box corresponds to a bit of the word data, and all the information is stored in 3 words.

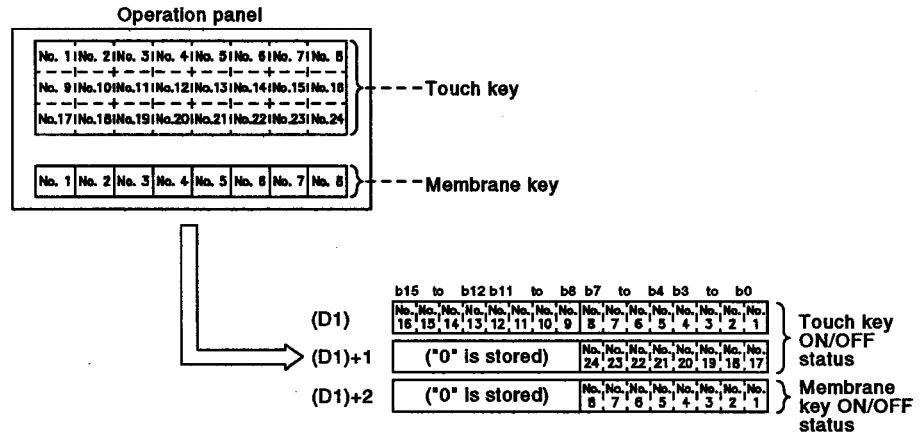

The status of bits in (D1) to (D1)+2 is as follows: "1" is stored in bits corresponding to ON keys, and "0" in bits corresponding to OFF keys.

- (4) The permissible number of received data designated at n1 is the setting made to secure the range of devices for storing received data, and the data storage destination is the device numbers starting from the device number designated at (D1) and equivalent to the number of points designated at n1. The number of data actually received is automatically stored in the n1+1 device number.

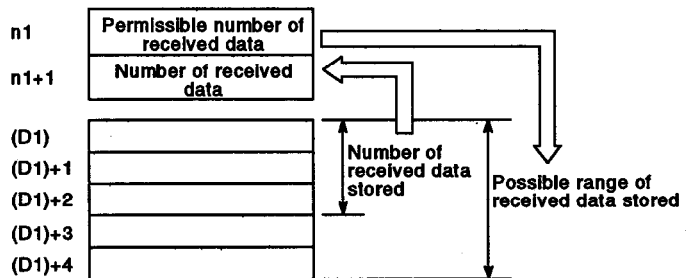

The number of data received due to key operation at the operation box is 3 words. Accordingly, set the permissible number of data designated in n1 to "3 or more". If "2 or less" is set, it is not possible to store the statuses for all key operations.

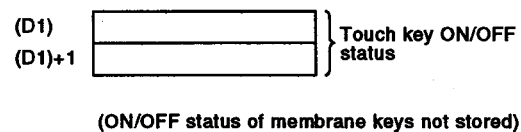

- (5) The bit device designated at (D2) automatically turns ON on execution of the END instruction of the scan completing receive processing, and turns OFF at the END instruction of the next scan.
Used as an execution completion flag for INPUT instructions.
- (6) The remote terminal number designated in n2 is the number previously set in initial data ROM for the corresponding operation box. The remote terminal number setting is conducted by the remote terminal data setting in the SW0SGP-MINIP initial data setting.
- (7) In reception of keyed-in data from the operation box, the ON/OFF status of the key reads by the INPUT instruction is held until the INPUT instruction is executed again.
If the ON/OFF statuses of multiple keys are changed between executions of the INPUT instruction, only the ON/OFF status of the first key changed is stored, and the ON/OFF status of keys changed after that cannot be detected.

POINT

Communication with a remote terminal module connected to AJ71PT32-S3 can only be conducted when the AJ71PT32-S3 communications start signal ($Y_{(n+28)}$) is ON.

If the instructions are executed when the communications start signal ($Y_{(n+28)}$) is OFF, no error occurs, but the bit device set for use as a completion flag does not turn ON.

Operation Errors

- (1) In the following cases an operation error occurs, the error flag (SM0) turns ON, and the error code is stored in SD0.
- When the range of the number of data designated at n2 from the device number designated at (D1) onwards exceeds the last device number of the corresponding device. (Error code: 4101)
 - When INPUT instructions are executed in other than the operation panel or AJ35PTF-R2. (Error code: 4104)
 - When the module attempting access is not a special function module. (Error code: 2110)
 - When AJ35PTF-R2 control instructions cannot be used for the designated module. (Error code: 2112)
 - When the designated instruction name is illegal. (Error code: 4300)
 - When the number of AJ35PTF-R2 control instruction devices is illegal. (Error code: 4301)
 - When a non-designatable device is designated. (Error code: 4302)

Program Example

- (1) The following is an example program which, when X0 turns ON, stores to D0-D2 the touch key and membrane key input status from an operation panel connected as remote terminal no.1 of the AJ71PT32-S3 installed at I/O numbers X/Y020 to X/Y04F. M0 turns ON at instruction execution completion.

[Ladder mode]

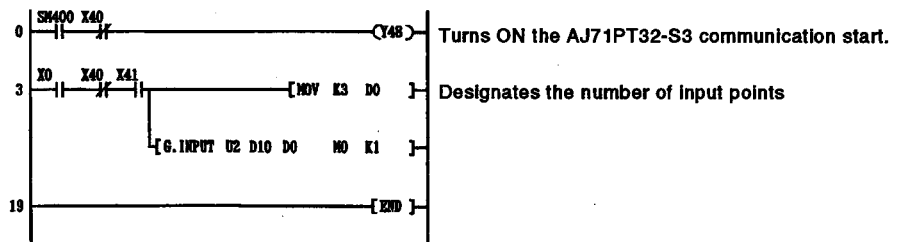

[List mode]

Step	Instruction	Device
0	LD	SM400
1	ANI	X40
2	OUT	Y48
3	LD	X0
4	ANI	X40
5	AND	X41
6	MOV	K3 D10
8	G.INPUT	U2 D10 D0 M0 K1
19	END	

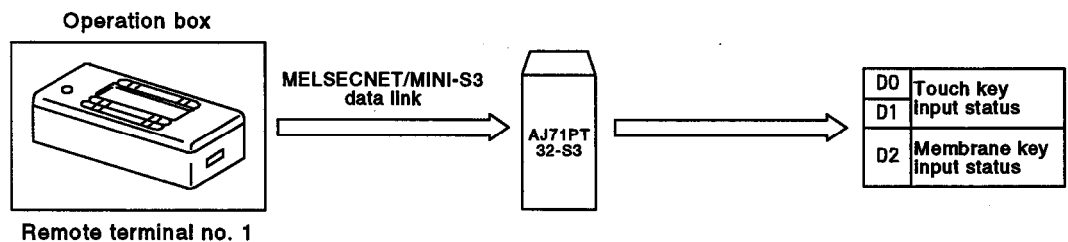

7.2 No-Protocol Mode Data Send of Designated Number of Bytes

Set Data	Usable Devices									
	Internal Device (System, User)		File Register	MELSECNET/10 Direct J::\::		Special Function Module U::\G::	Index Register Zn	Constant		Other
	Bit	Word		Bit	Word			K, H	\$	
n1	○	○				○		○	—	—
(S)	—	○				—		—	○	—
(D)	○	○				—		—	—	—
n2	○	○				○		○	—	—

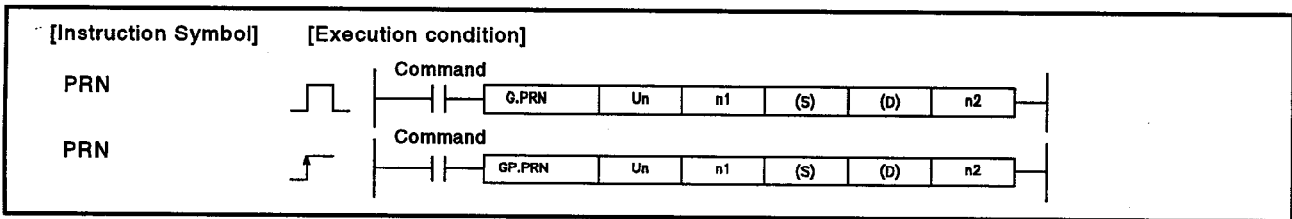

Set Data

Set Data	Description	Data Type
Un	AJ71PT32-S3 head I/O number	16-bit binary
n1	Number of send data (words or bytes)	
(S)	Head number of device storing send data	Character string
(D)	Number of the bit device turning ON on completion of processing	Bit
n2	Remote terminal number of AJ35PTF-R2 sending data	16-bit binary

Function

- Transmits data in no-protocol mode from AJ71PT32-S3 remote terminal No.n2 AJ35PTF-R2 to external device. The transmitted data is set in n1 number of points from the device number designated at (S) onwards. When send processing is completed, automatically turns ON the bit device designated at (D) after only 1 scan.

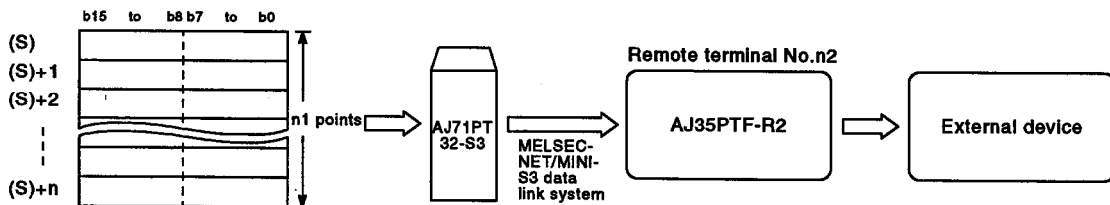

When n1=9bytes

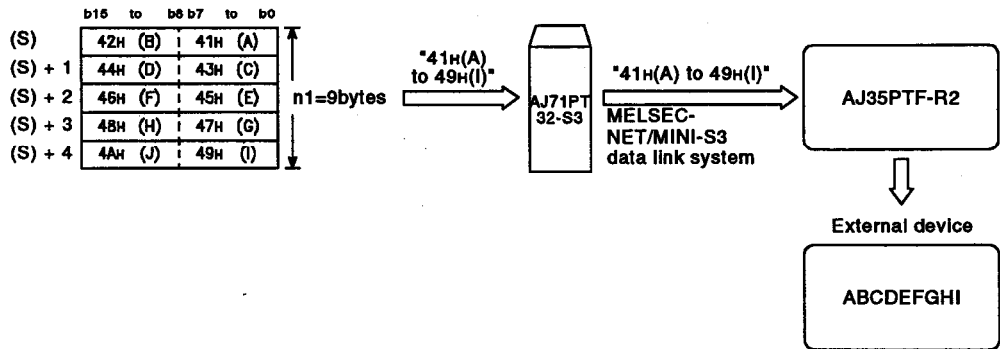

- (2) In send processing by the PRN instruction, writing of transmission data to AJ71PT32-S3 buffer memory, and ON/OFF processing of I/O signal request to send/send completion are conducted automatically by internal processing, so do not need to be conducted by the user.
- (3) The number of data designated at n1 can be set within the following ranges.

Word unit..... 1 to (TO area setting capacity - 1) words
 Byte unit..... 1 to (TO area setting capacity - 1) x 2 bytes

When using the AJ71PT32-S3, the data unit (word or byte), and the TO area must be set in advance in the AJ71PT32-S3.

- Data unit designation..... Set in the AJ71PT32-S3 buffer memory remote terminal parameter by TO instruction.
- TO area setting..... Set in the initial data ROM by remote terminal data setting in initial data setting using SW0SGP-MINIP.

- (4) The unit of the number of data designated at n1, and the allowable setting range differ depending on the TO area setting in the AJ71PT32-S3 data unit designation (word/byte), and the initial data remote terminal setting. Furthermore the send data set in (S) also differs depending on the word/byte unit.

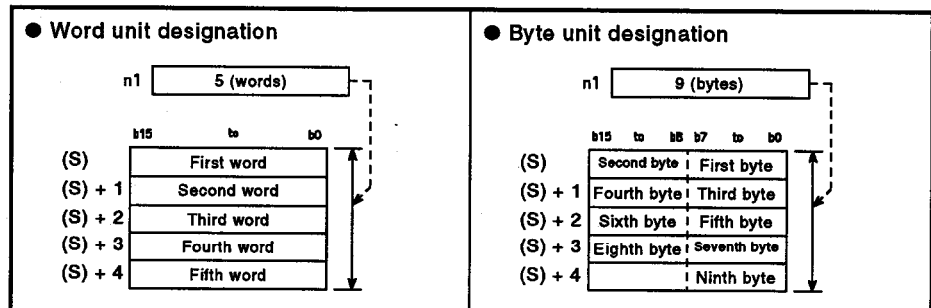

- (5) The remote terminal number designated in n2 is the number previously set in the initial data ROM for the corresponding AJ35PTF-R2. The remote terminal number setting is conducted by the remote terminal data setting in the SW0SGP-MINIP initial data setting.
- (6) The bit device designated at (D) automatically turns ON on execution of the END instruction of the scan completing the transmission processing, and turns OFF at the END instruction of the next scan. Used as an execution completion flag for PRN instructions.

POINT

Communication with a remote terminal module connected to AJ71PT32-S3 can only be conducted when the AJ71PT32-S3 communications start signal ($Y_{(n+28)}$) is ON. If the instruction is executed when the communications start signal (Y_{28}) is OFF, no error occurs, but the bit device set for use as a completion flag will not turn ON.

Operation Error

- (1) In the following cases an operation error occurs, the error flag (SM0) turns ON, and the error code is stored in SD0.
- When the number of data designated at n1 exceeds the following range. (Error code: 4100)
 - Word unit..... 1 to (TO area setting capacity - 1) words
 - Byte unit..... 1 to (TO area setting capacity - 1) x 2 bytes
 - When the range of number of data designated at n1 from the device number designated at (S) onwards exceeds the last device number of the applicable device. (Error code: 4101)
 - When PRN instructions are executed for other than the AJ35PTF-R2. (Error code: 4104)
 - When the character string designated at (S) is smaller than the character string designated at n. (Error code: 4100)
 - When the module attempting access is not a special function module. (Error code: 2110)
 - When AJ71PT32-S3 control instructions cannot be used for the designated module. (Error code: 2112)

- When the designated instruction name is illegal. (Error code: 4300)
- When the number of AJ71PT32-S3 control instruction devices is illegal. (Error code: 4301)
- When a non-designatable device is designated. (Error code: 4302)

Program Example

(1) A program which, when X0 turns ON, sends D0-D4 data in word units to an external device connected to a remote terminal no. 1 AJ35PTF-R2 of a AJ71PT32-S3 installed in I/O number X/Y020-X/Y04F is shown here. M0 turns ON at instruction execution completion.

[Ladder mode]

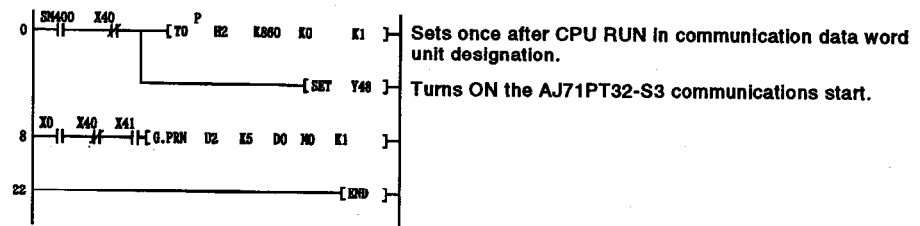

[List mode]

Step	Instruction	Device
0	LD	SM400
1	ANI	X40
2	TOP	K860 KO K1
7	SET	Y48
8	LD	X0
9	ANI	X40
10	AND	X41
11	G.PRN	U2 K5 DO M0 KI
22	END	

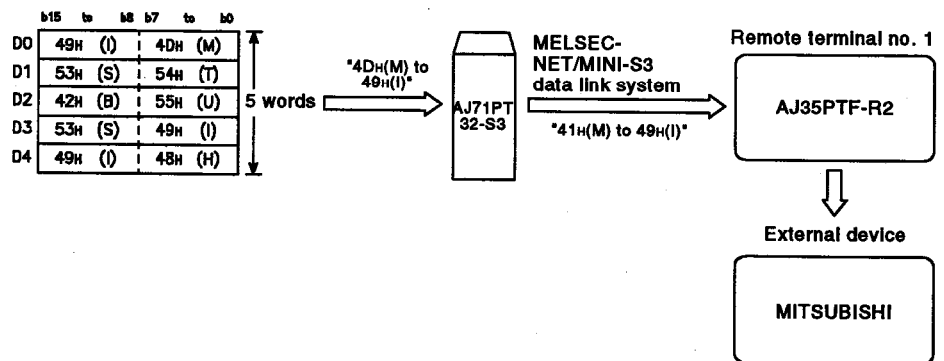

7.3 No-Protocol Mode Data Send up until "00H" Code

Set Data	Usable Devices									
	Internal Device (System, User)		File Register	MELSECNET/10 Direct J::\::		Special Function Module U::\G::	Index Register Zn	Constant		Other
	Bit	Word		Bit	Word			K, H	\$	
(S)	—	○				—		○	—	
(D)	○	○				—		—	—	
n	○	○				○		—	—	

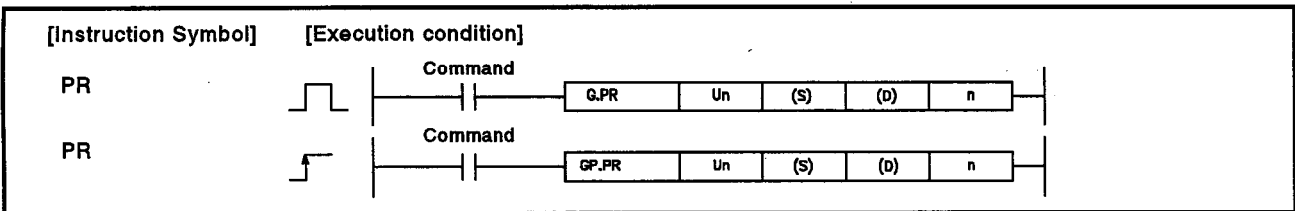

Set Data

Set Data	Description	Data Type
Un	AJ71PT32-S3 head I/O number	16-bit binary
(S)	Head number of device storing send data	Character string
(D)	Number of the bit device turning ON on completion of processing	Bit
n	Remote terminal number of AJ35PTF-R2 sending data	Device name

Function

- Sends data between the device number designated at (S) and the device number storing "00H", to an external device connected to the AJ35PTF-R2 whose remote terminal No. is "n", of the AJ71PT32-S3. When send processing is completed, automatically turns ON the bit device designated at (D) after only 1 scan.

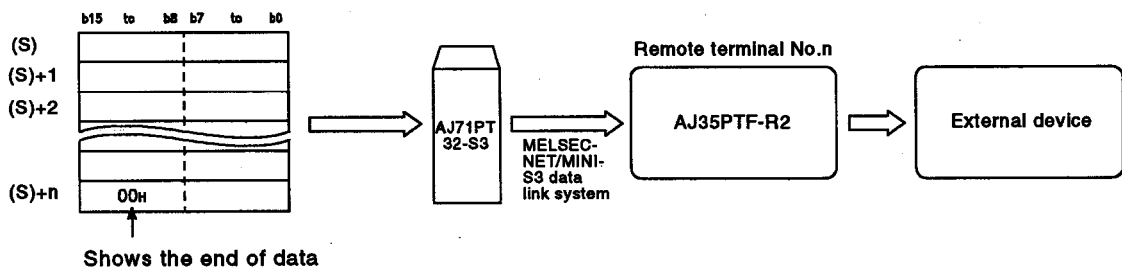

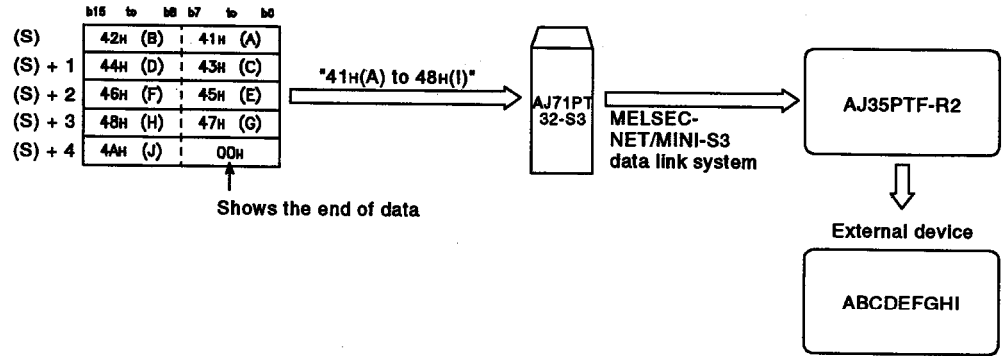

(2) In send processing by PRN instructions, writing of transmission data to AJ71PT32-S3 buffer memory, and ON/OFF processing of I/O signal request to send/send completion are conducted automatically by internal processing, so does not need to be conducted by the user.

(3) The number of data which can be sent at one time is shown below.

Word unit..... 1 to (TO area setting capacity-1) words
 Byte unit..... 1 to (TO area setting capacity-1) x 2 bytes

When using the AJ71PT32-S3, the data unit (word or byte), and the TO area must be set in advance in the AJ71PT32-S3.

- Data unit designation..... Set in the AJ71PT32-S3 buffer memory remote terminal parameter by TO instruction.
- TO area setting..... Set in the initial data ROM by remote terminal data setting in initial data setting using SW0SGP-MINIP.

(4) The send data set in (S) differs depending on the data unit designation (word/byte) set in AJ71PT32-S3.

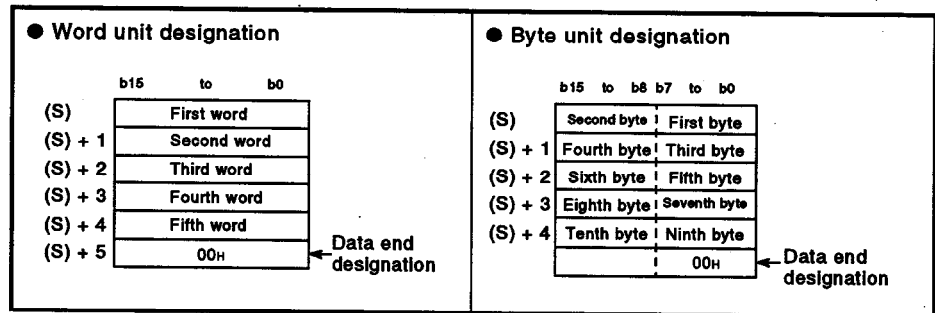

- (5) The remote terminal number designated at n is the number previously set in the initial data ROM for the corresponding AJ35PTF-R2. The remote terminal number setting is conducted by the remote terminal data setting in the SW0SGP-MINIP initial data setting.
- (6) The bit device designated at (D) automatically turns ON on execution of the END instruction of the scan completing the transmission processing, and turns OFF at the END instruction of the next scan. Used as an execution completion flag for PRN instructions.

POINT

Communication with a remote terminal module connected to AJ71PT32-S3 can only be conducted when the AJ71PT32-S3 communications start signal ($Y_{(n+28)}$) is ON. If the instructions are executed when the communications start signal (Y_{28}) is OFF, no error occurs, however the bit device set for use as a completion flag will not turn ON.

Operation Errors

- (1) In the following cases an operation error occurs, the error flag (SM0) turns ON, and the error code is stored in SD0.
- No "00H" code is stored between the device number designated at (S) and the final device number of the relevant device. (Error code: 4100)
 - When the number of send data is outside the following range. (Error code: 4100)
 - Word unit..... 1 to (TO area setting capacity-1) words
 - Byte unit..... 1 to (TO area setting capacity-1) x 2 bytes
 - When PR instructions are executed for other than the AJ35PTF-R2. (Error code: 4104)
 - When the module attempting access is not a special function module. (Error code: 2110)
 - When AJ71PT32-S3 control instructions cannot be used in the designated module. (Error code: 2112)
 - When the designated instruction name is illegal. (Error code: 4300)
 - When the number of AJ71PT32-S3 control instruction devices is illegal. (Error code: 4301)
 - When a non-designatable device is designated. (Error code: 4302)

Program Example

- (1) A program which, when X0 turns ON, sends the data between D0 and 00H in word units to the external device connected to the AJ35PTF-R2 whose remote terminal No. is "1" of the AJ71PT32-S3 which is installed at I/O number X/Y020-X/Y04F is shown here.
M0 turns ON at instruction execution completion.

[Ladder mode]

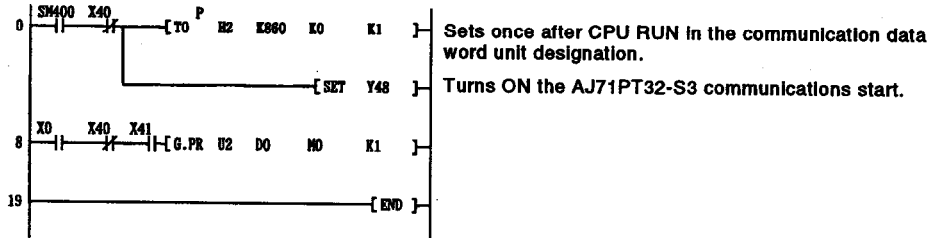

[List mode]

Step	Instruction	Device
0	LD	SM400
1	ANI	X40
2	TOP	H2 K860 K1
7	SET	Y48
8	LD	X0
9	ANI	X40
10	AND	X41
11	G.P.R.	U2 D0 M0 K1
19	END	

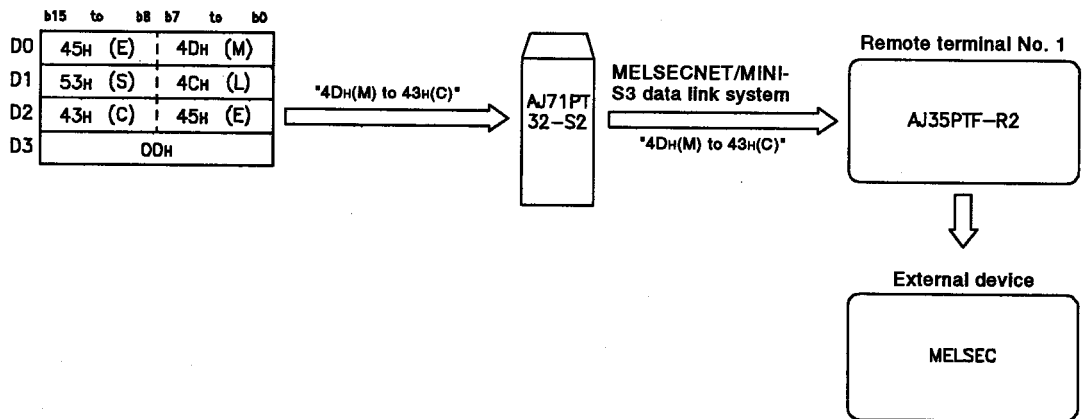

7.4 No-Protocol Mode Data Receive

Set Data	Usable Devices								
	Internal Device (System, User)		File Register	MELSECNET/10 Direct J3\3		Special Function Module U3\G3	Index Register Zn	Constant K, H	Other
	Bit	Word		Bit	Word				
n1	—	0				—		—	
(D1)	—	0				—		—	
(D2)	0	0				—		—	
n2	0	0				0		—	

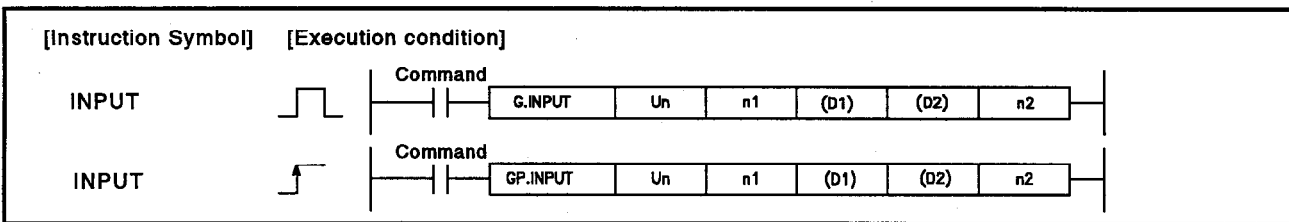

Set Data

Set Data	Description	Data Type
Un	AJ71PT32-S3 head I/O number	16-bit binary
n1	Permissible number of received data, and number of received data	
(D1)	Head number of device storing received data	Device name
(D2)	Number of the bit device turning ON on completion of processing	Bit
n2	Remote terminal number of AJ35PTF-R2 receiving data	16-bit binary

Function

- Receives data, within the permissible range designated at n1, from the external device connected to AJ71PT32-S3 remote terminal No.n2 AJ35PTF-R2, and stores data from device number designated at (D1) onwards.
When receive processing is completed, automatically turns ON bit device designated at (D2) after only 1 scan.

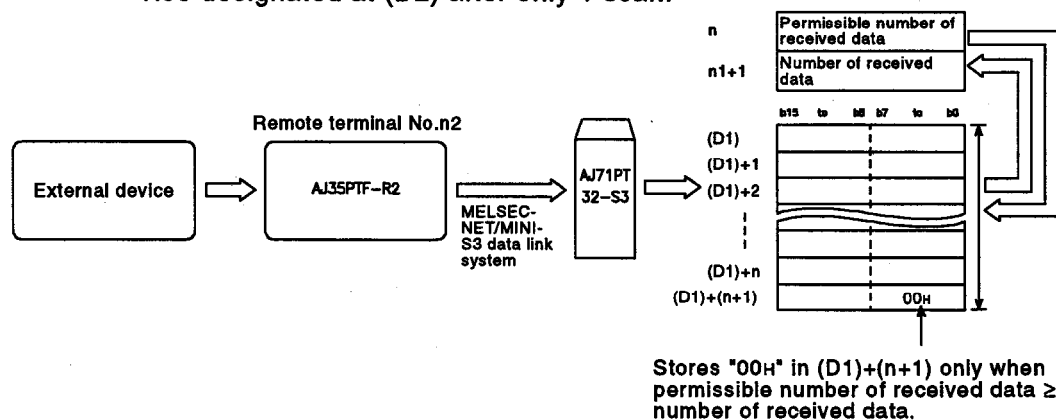

POINTS

- (1) The G(P).INPUT command cannot be made into a pulse.
- (2) Execute G(P).INPUT when I/O signal read request is ON.

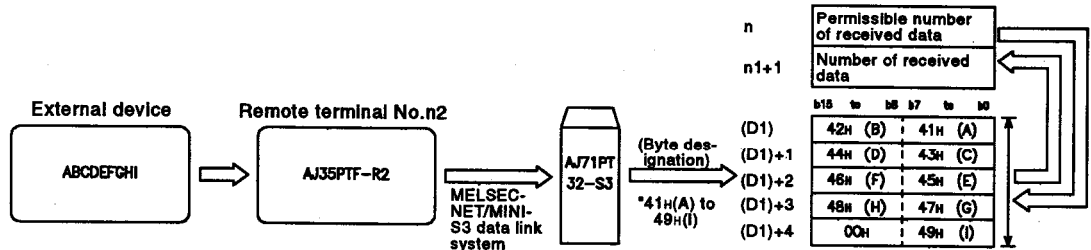

(2) In receive processing by INPUT instructions, reading of data received in the AJ71PT32-S3 buffer memory, and ON/OFF processing of request to read I/O signal and read completed are conducted automatically by internal processing, and so do not need to be conducted by the user.

(3) The number of data that can be received in one receive processing is shown below.

Word unit.....Max. (FROM area setting capacity - 1) words
 Byte unit.....Min. (FROM area setting capacity - 1) x 2 bytes

When using the AJ71PT32-S3, the data unit (word or byte), and the FROM area must be set in advance in the AJ71PT32-S3.

- Data unit designation..... Set in the AJ71PT32-S3 buffer memory remote terminal parameter by TO instruction.
- FROM area setting..... Set in the initial data ROM by remote terminal data setting in initial data setting using SW0SGP-MINIP.

(4) The permissible number of received data designated at n1 is the setting made to secure the range of devices for storing received data, and the data storage destination is the device numbers starting from the device number designated at (D1) and equivalent to the number of points designated at n1.
 The number of data actually received is automatically stored in n+1.

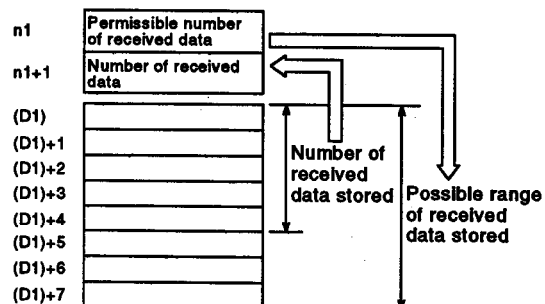

- (5) When the number of data actually received is larger than the permissible number of received data designated at n1, only the permissible number of received data is stored, and the remaining received data is discarded.
- (6) The n1 and n1+1 setting value and storage value units differ depending on the AJ71PT32-S3 data unit designation (word/byte). The data stored in (D1) also differs depending whether the word or byte unit is designated.

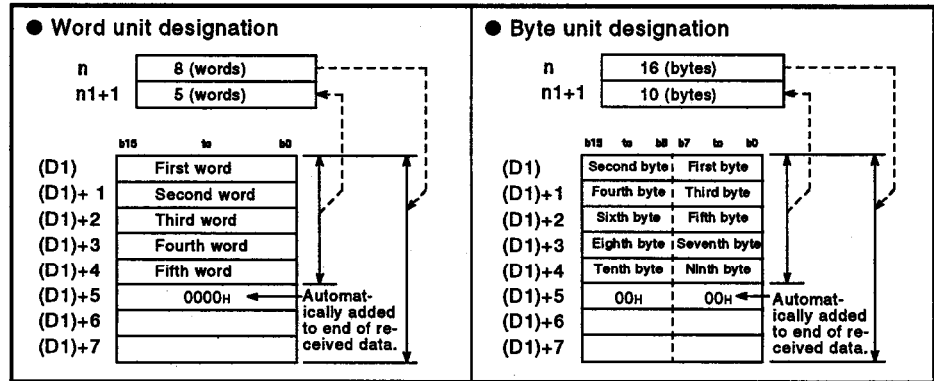

- (7) In byte unit designation, depending on whether the received data is odd or even numbered, the "00H" code added to the end of the received data is stored as below.
 - Received data is an odd number..... Stored in the higher bytes of the last device number storing received data.
 - Received data is an even number..... Stored in the device number subsequent to the last device number storing received data.

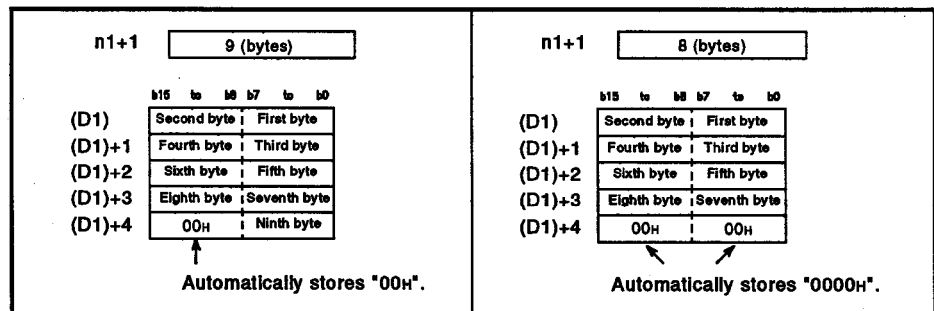

- (8) When the number of received data is higher than the permissible number of received data, the "00H" code which is added to the end of the received data is stored in the next device number to the device number of the permissible number of received data.

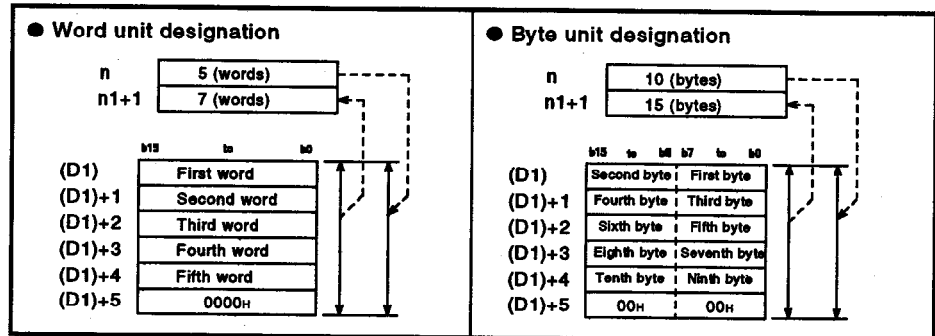

- (9) The remote terminal number designated in n2 is the number previously set in the initial data ROM for the corresponding AJ35PTF-R2. The remote terminal number setting is conducted by the remote terminal data setting in the SW0SGP-MINIP initial data setting.
- (10) The bit device designated at (D2) automatically turns ON on execution of the END instruction of the scan completing receive processing, and turns OFF at the END instruction of the next scan. Used as an execution completion flag for INPUT instructions.
- (11) In AJ35PTF-R2 data reception, received data is kept until receive processing is conducted due to an INPUT instruction. Accordingly, external devices cannot transmit the next data to the same AJ35PTF-R2.

POINT

Communication with a remote terminal module connected to AJ71PT32-S3 can only be conducted when the AJ71PT32-S3 communications start signal ($Y_{(n+28)}$) is ON. If the instructions are executed when the communications start signal ($Y_{(n+28)}$) is OFF, no error occurs, but the bit device set for use as a completion flag does not turn ON.

Operation Errors

- (1) In the following cases an operation error occurs, the error flag (SM0) turns ON, and the error code is stored in SD0.
 - When the range of number designated at n1 from the device number designated from (D1) onwards exceeds the last device number of the applicable device. (Error code: 4101)
 - When INPUT instructions are executed for other than AJ35PTF-R2 and operations box. (Error code: 4104)
 - When the module attempting access is not a special function module. (Error code: 2110)
 - When AJ71PT32-S3 control instructions cannot be used in the designated module. (Error code: 2112)
 - When the designated instruction name is illegal. (Error code: 4300)
 - When the number of AJ71PT32-S3 control instruction devices is illegal. (Error code: 4301)
 - When a non-designatable device is designated. (Error code: 4302)

Program Example

- (1) A program which, when X0 turns ON, receives 5-word data from the external device connected to remote terminal no.1 AJ35PTF-R2 of AJ71PT32-S3 installed in I/O number X/Y020-X/Y04F, and stores the data to D0-D4.

[Ladder mode]

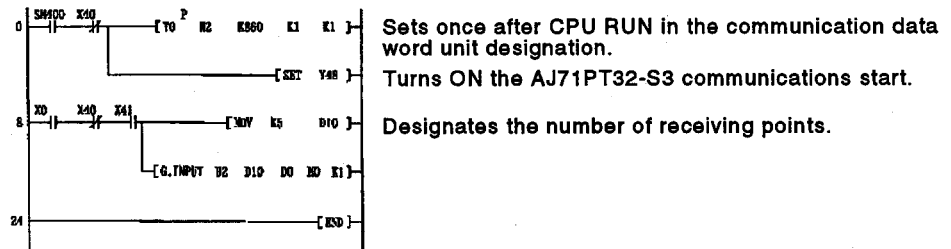

[List mode]

Step	Instruction	Device
0	LD	SM400
1	ANI	X40
2	TOP	H2 K860 K1 K1
7	SET	Y48
8	LD	X0
9	ANI	X40
10	AND	X41
11	MOV	K5 D10
13	G.INPUT	U2 D10 D0 D0 D0 K1
24	END	

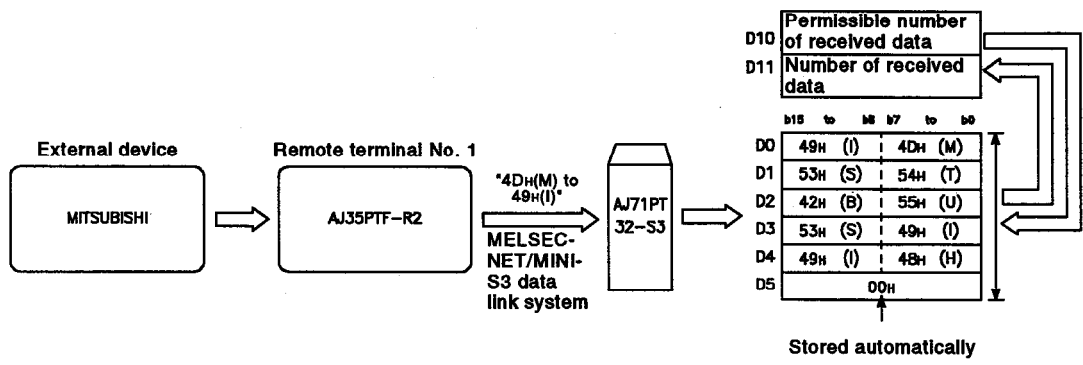

7.5 Remote Terminal Module Communication

Set Data	Usable Devices								
	Internal Device (System, User)		File Register	MELSECNET/10 Direct I/O		Special Function Module Usage	Index Register Zn	Constant K, H	Other
	Bit	Word		Bit	Word				
n1	○	○				○		—	
n2	○	○				○		—	
(D1)	—	○				—		—	
(S)	—	○				—		—	
n3	○	○				○		—	
(D2)	O(X, Y possible)	○				—		—	
(D3)	O(Y only)	—				—		—	

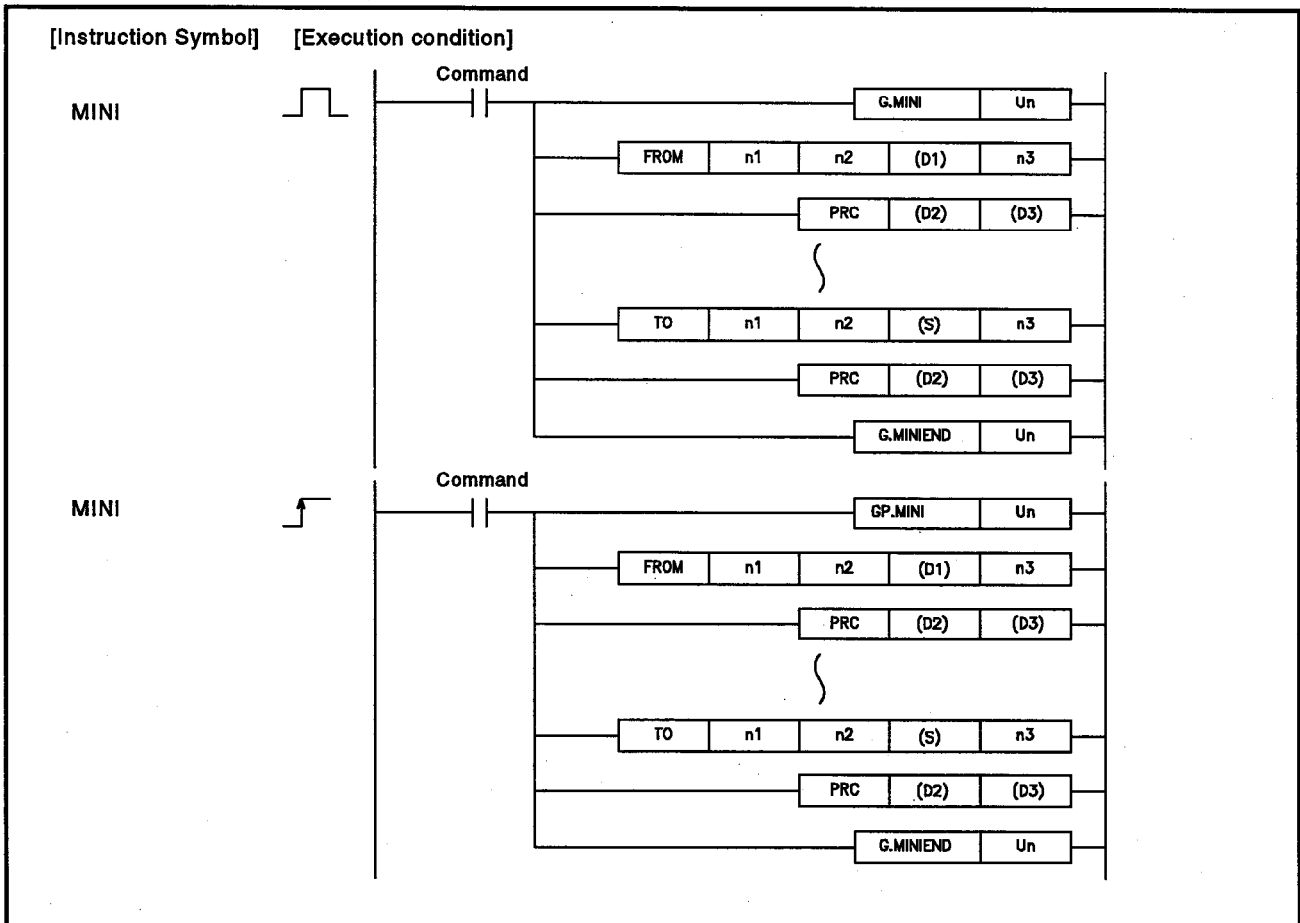

Set Data

Set Data	Description	Data Type
Un	AJ71PT32-S3 head I/O number	16-bit binary
n1	Module number of communicating remote terminal module	
n2	First address number of area (buffer memory) conducting remote terminal module communication	
(D1)	First number of device storing data to be read	Device name
(S)	First device number of devices in which data to be written is stored.	
n3	Number of points of data subject to reading/writing	16-bit binary
(D2)	Number of the bit device turning ON on completion of processing	Bit
(D3)	Any dummy output (Y) device number (no operation)	Bit

Function

- (1) Out of the remote terminal modules connected to AJ71PT32-S3, conducts communications with remote terminal module designated at n1. MINI standard protocol conforming remote terminal modules can communicate by MINI instructions.
- (2) In communications with remote terminal modules by MINI instructions, the AJ71PT32-S3 request to send/send completed signal, request to read/read completed signal, and buffer memory address are automatically controlled, and so do not need to be set by the user.
- (3) MINI instructions are used in combination with FROM/TO instructions and PRC instructions, and the group of instructions must always be ended by a MINIEND instruction. Between MINI-MINIEND instructions, a maximum of 32 FROM/TO instructions can be described. PRC instructions are used as FROM/TO instructions.

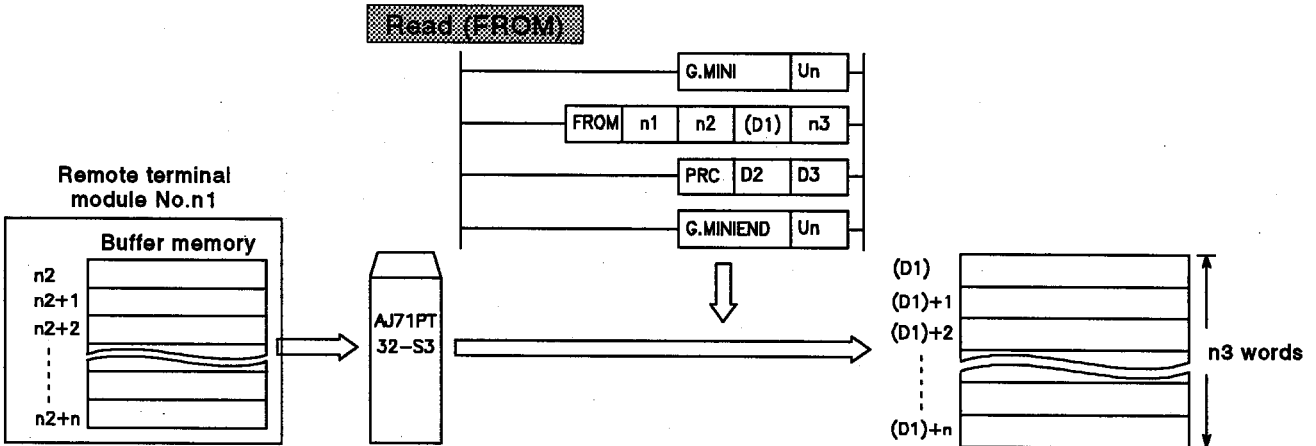

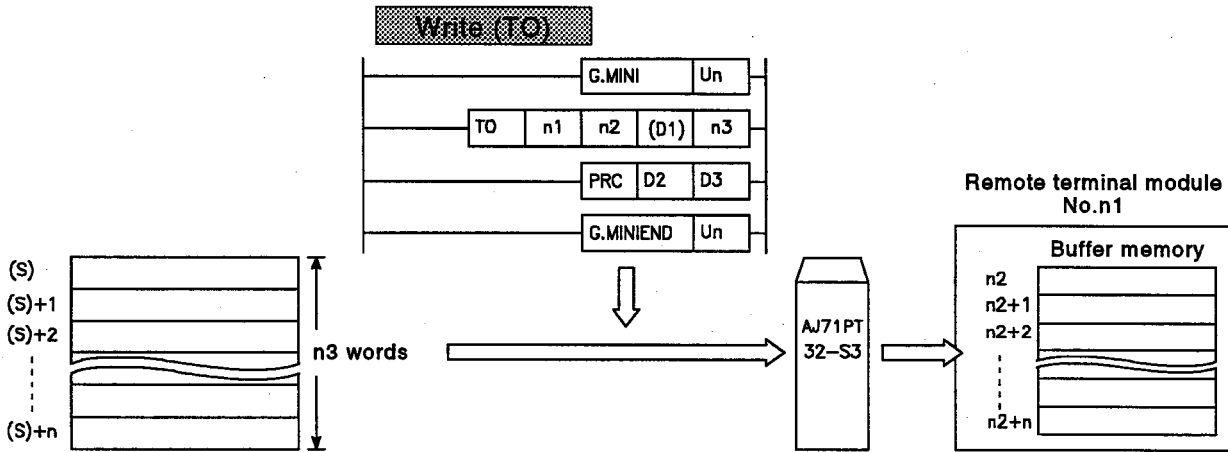

- (4) The remote terminal module number designated at n1 sets allocated module numbers for remote terminal modules conducting communications.
The remote terminal module number is the allocated number in the AJ71PT32-S3 initial data ROM setting for each remote terminal module.
- (5) The buffer memory designated in n2 designates the head number of the buffer memory address of the remote terminal module which conducts communications.
The communicating area is the range of the number of points designated at n3 from the address number designated at n2 onwards. See the User's Manual for each remote terminal module for details on buffer memory addresses.
- (6) The device number designated at (D1) designates the first number of the device storing the read data.
The read data is stored in the range of the number of points designated at n3 from the device number designated at (D1) onwards.
- (7) The data or device number designated at (S) designates the data written to the remote terminal module, as well as the first number of the device storing data written to the remote terminal module.
If a constant is designated, the designated value is written to the designated address number of the remote terminal module onwards in the number of points designated in n3.
When a device number is designated, the data stored from the designated device number onwards, within the range of points designated at n3, is written to the designated address number and onwards of the remote terminal module.
- (8) The number of points designated at n3 designates the number of points for which reading/writing is to be performed.

- (9) The bit device designated at (D2) is used as a communications processing completion flag. Automatically turns ON on execution of the END instruction for the scan completing the communication processing with the applicable remote terminal module, and automatically turns OFF at the END instruction of the next scan.

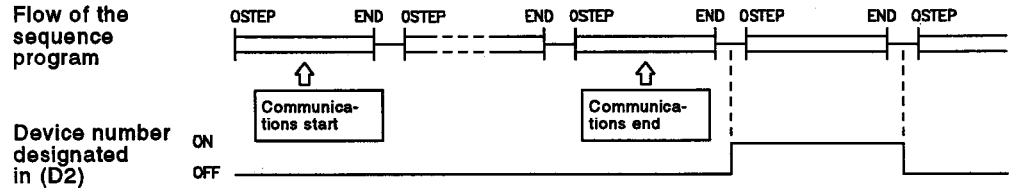

- (10) Items designated at (D3) are meaningless (no operation) dummy information, so set any output device number. Communication processing by MINI instructions with remote terminal modules can communicate simultaneously for all AJ71PT32-S3s with a maximum of 32 remote terminal modules.

- (11) The method of communication, as shown below, is to conduct registration in the communication request registration area by executing FROM/TO instructions, and then conduct communication processing in accordance with the registered contents. Execution of instructions is completed by conducting registration in the communication request registration area, and executing the following instructions.

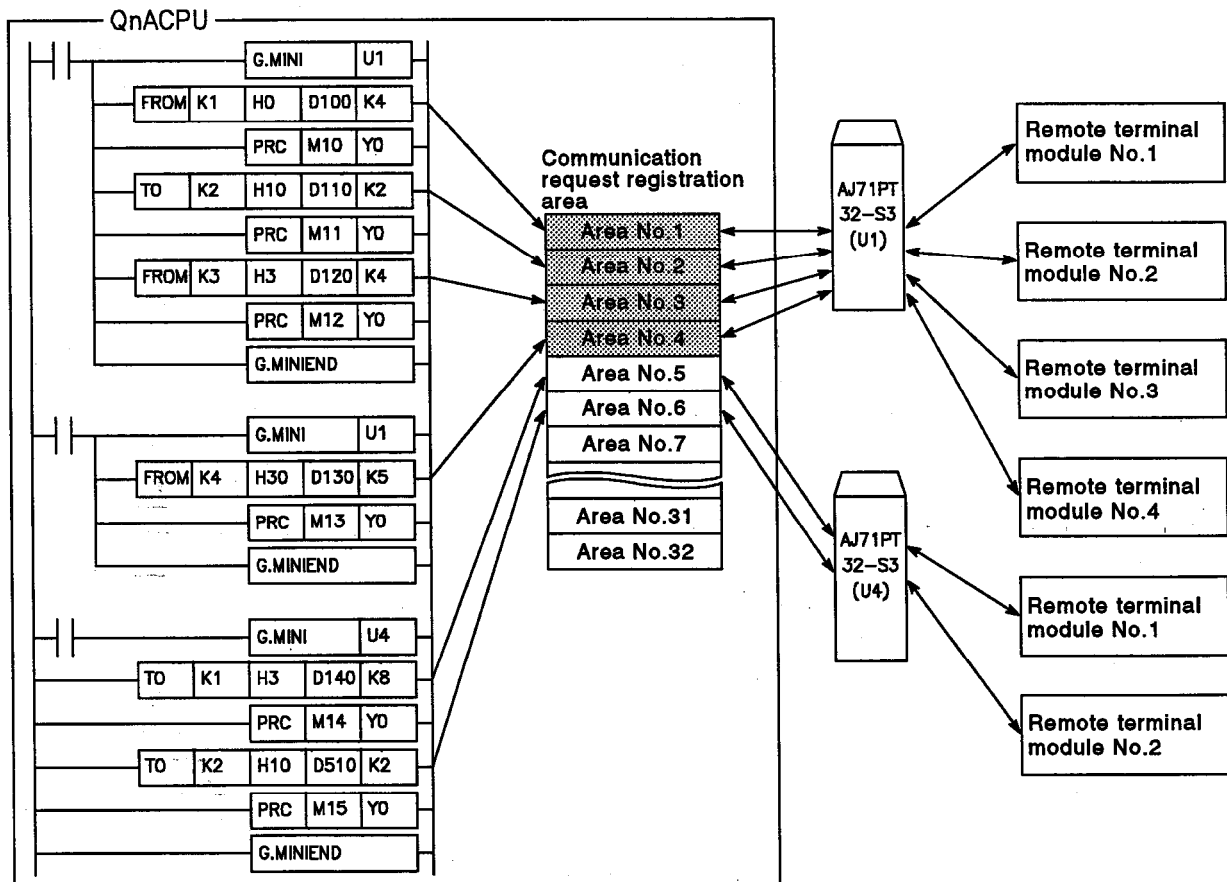

- (12) During registration in the communication request registration area, the device number of the bit device designated at (D2) is checked, and the registration will not be processed if the same device number is already being used in processing.
- (13) When processing in accordance with the registered contents is completed, the device designated at (D2) is turned ON, and the data is deleted from the communication request registration area.
- (14) The communication request registration area can register a maximum of 32 communication requests.
If the number of registrations exceeds 32, an error occurs and no registering takes place.
- (15) The status of registering to the communication request registration area can be confirmed by means of SM713 and SD713.
 - SM713..... Turns ON when there is no registrable area in the communication request registration area, and automatically turns OFF when there is a vacancy in the area.
 - SD713..... Stores the remaining number of registrations which can be made in the communication request registration area.

SM713 and SD713 can be used in handshake signals when executing instructions.
- (16) When instructions are executed with respect to remote terminal modules during communication, processing is conducted for the same remote terminal module following completion of online processing.
- (17) See the User's Manual for each remote terminal module conforming to MINI standard protocol for details about the method of use of MINI instructions, and about the programming method.

POINT

Communication with a remote terminal module connected to AJ71PT32-S3 can only be conducted when the AJ71PT32-S3 communications start signal (Y_(n+28)) is ON.
If the instructions are executed when the communications start signal is OFF, no error occurs, however the bit device set for use as a completion flag will not turn ON.

Operation Errors

- (1) In the following cases an operation errors occurs, the error flag (SM0) turns ON, and the error code is stored in SD0.
- When MINI instructions are executed for modules apart from AJ71PT32-S3. (Error code: 4104)
 - When the communicating node destination module is not a remote terminal module conforming to MINI standard protocol. (Error code: 4104)
 - When, in the FROM/TO instructions, the range of numbers of points designated at n3 from the device number designated at (D1) and (S) onwards exceeds the last device number of the applicable device (Error code: 4101)
 - When, for FROM instructions, the number of points designated at n3 is greater than each remote terminal module receive area set value in the AJ71PT32-S3 initial data settings minus 1. (Error code: 4100)
 - When any of the remote terminal module receive area set values in the AJ71PT32-S3 initial data settings is less than 3 words. (Error code: 4100)
 - When, for a TO instruction, the number of points designated at n3 is greater than each of the remote terminal module send area set values in the AJ71PT32-S3 initial data settings minus 3. (Error code: 4100)
 - When the communication request registration area is full and cannot conduct registration when FROM/TO instructions are executed. (Error code: 4100)
 - When the module attempting access is not a special function module. (Error code: 2110)
 - When AJ71PT32-S3 control instructions cannot be used in the designated module. (Error code: 2112)
 - When the designated instruction name is illegal. (Error code: 4300)
 - When the number of AJ71PT32-S3 control instruction devices is illegal. (Error code: 4301)
 - When a non-designatable device is designated. (Error code: 4302)

7.6 Remote Terminal Module Error Reset

Set Data	Usable Devices								
	Internal Device (System, User)		File Register	MELSECNET/10 Direct J-BUS		Special Function Module USAGE	Index Register Zn	Constant	Other
	Bit	Word		Bit	Word				
—									

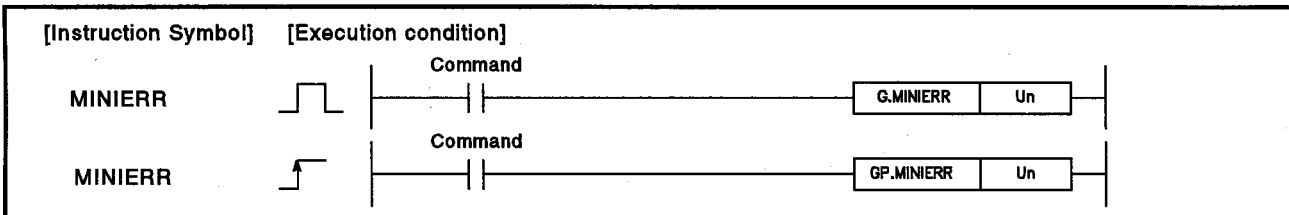

Function

- (1) Resets the error-detected status for AJ71PT32-S3 remote terminal module.
- (2) By the error-detected status reset, automatically turns ON the AJ71PT32-S3 I/O number remote terminal module error-detected reset signal (Y24).
When error-detected status reset is completed, automatically turns OFF the error-detected reset signal (Y24).

Operation Errors

- (1) In the following cases an operation error occurs, the error flag (SM0) turns ON, and the error code is stored in SD0.
 - When the module attempting access is not a special function module. (Error code: 2110)
 - When AJ71PT32-S3 control instructions cannot be used in the designated module. (Error code: 2112)
 - When the designated instruction name is illegal. (Error code: 4300)
 - When the number of AJ71PT32-S3 control instruction devices is illegal. (Error code: 4301)
 - When a non-designatable device is designated. (Error code: 4302)

Program Example

- (1) A program which resets the remote terminal error detection of the AJ71PT32-S3 installed in I/O number X/Y020-X/Y04F is shown here.

[Ladder mode]

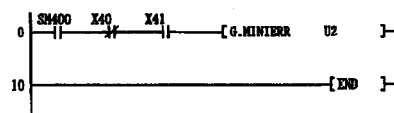

[List mode]

Step	Instruction	Device
0	LD	SM400
1	ANI	X40
2	AND	X41
3	G.MINIERR	U2
10	END	

7.7 Reading Communication Status

Set Data	Usable Devices								
	Internal Device (System, User)		File Register	MELSECNET/10 Direct I/O		Special Function Module U ₀ /G ₀	Index Register Zn	Constant	Other
	Bit	Word		Bit	Word				
(D)	0		—						

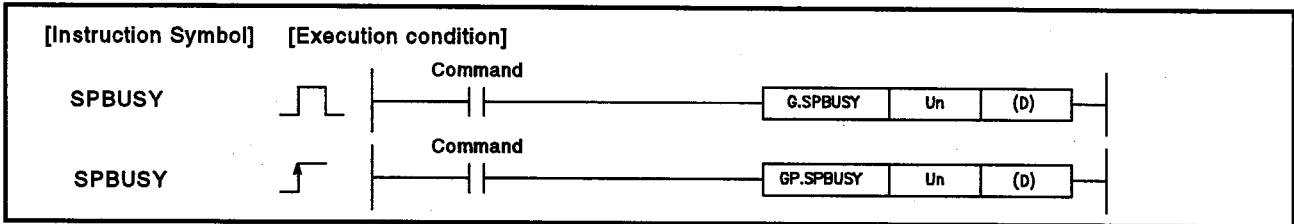

Set Data

Set Data	Description	Data Type
(D)	Device number storing read communication status	Device name

Function

- Reads the execution statuses of the following instructions with respect to the remote terminal module connected to AJ71PT32-S3, and stores them in the device designated at (D).

Key input from operation box..... INPUT instructions
 Data communications with AJ35PTF-R2..... PRN, PR, INPUT instructions

Communication of data with remote terminal modules conforming to MINI standard protocol..... MINI instructions

- The execution status stored in (D) is "1" at the start of data communication processing in remote terminal modules by instructions, and is "0" when the processing is completed.

The point when processing of the instruction is completed is when the instruction completion flag (designated bit device) turns from ON to OFF.

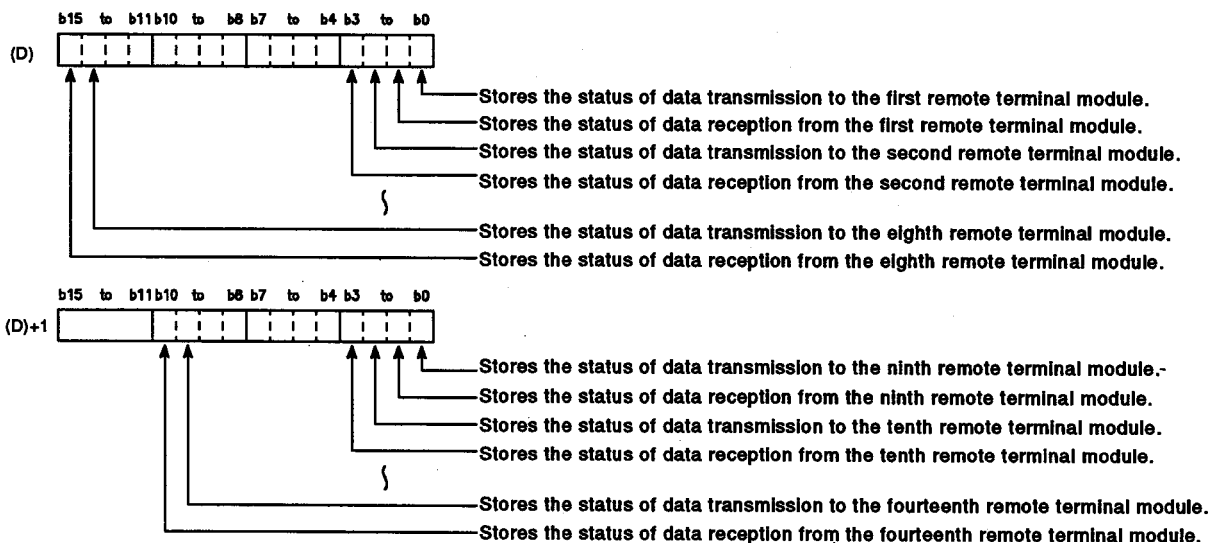

Operation Error

- (1) In the following cases an operation error occurs, the error flag (SM0) turns ON, and the error code is stored in SD0.
 - When the module attempting access is not a special function module. (Error code: 2110)
 - When AJ71PT32-S3 control instructions cannot be used with the designated module. (Error code: 2112)
 - When the designated instruction name is illegal. (Error code: 4300)
 - When the number of AJ71PT32-S3 control instruction devices is illegal. (Error code: 4301)
 - When a non-designatable device is designated. (Error code: 4302)

Program Example

- (1) A program which turns M10 ON when remote terminal no.1 of AJ71PT32-S3 installed in I/O number X/Y020-X/Y04F is sending data.

[Ladder mode]

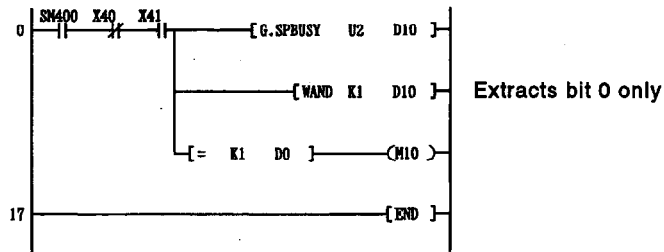

[List mode]

Step	Instruction	Device
0	LD	SM400
1	ANI	X40
2	AND	X41
3	G.SPBUSY	U2 D10
10	WAND	K1 D10
13	AND=	K1 D0
16	OUT	M10
17	END	

7.8 Forced Stop of Communication Processing

Set Data	Usable Devices								
	Internal Device (System, User)		File Register	MELSECNET/10 Direct I/O		Special Function Module UNIT	Index Register Zn	Constant	Other
	Bit	Word		Bit	Word				
(S)	0		—						

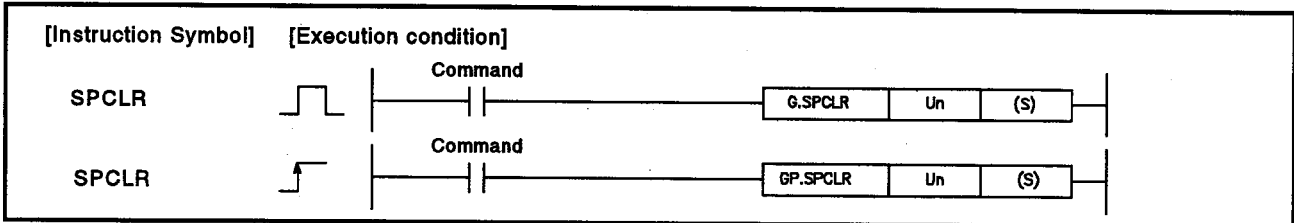

Set Data

Set Data	Description	Data Type
Un	AJ71PT32-S3 head I/O number	16-bit binary
(S)	First number of the devices in which the stop designation data is stored.	Device name

Function

- Forcibly cancels communications processing by the following instructions with the remote terminal module connected to AJ71PT32-S3.
 - Key input from operation box..... INPUT instructions
 - Data communications with AJ35PTF-R2..... PRN, PR, INPUT instructions
 - Communication of data with remote terminal modules conforming to MINI standard protocol..... MINI instructions
- The setting for cancel processing is made at (S). The cancel setting is conducted by setting "1" in the applicable device for cancel processing.

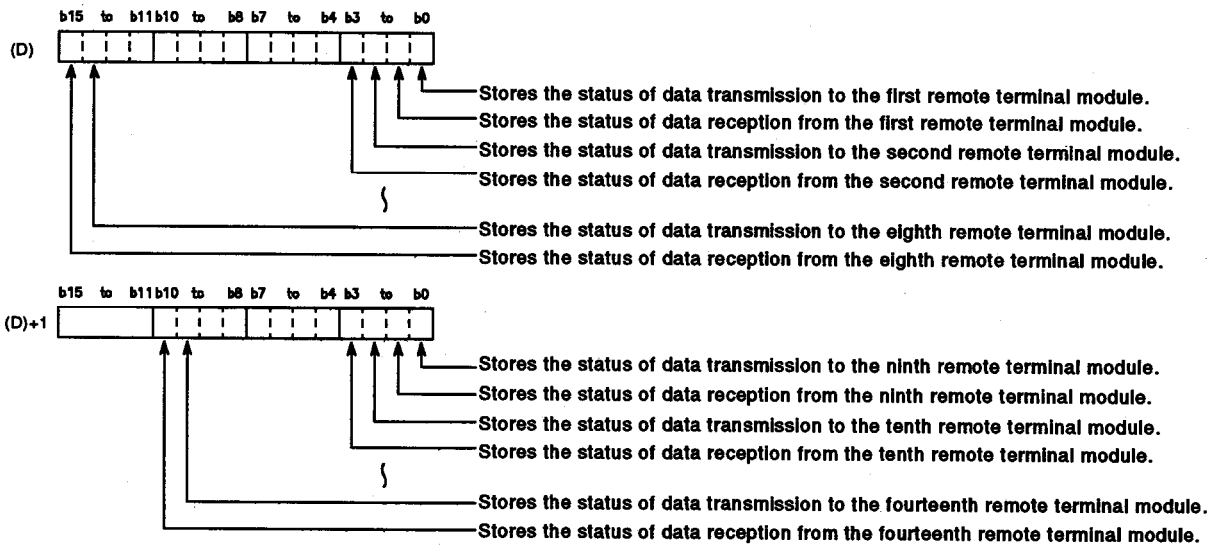

Operation Errors

- (1) In the following cases an operation error occurs, the error flag (SM0) turns ON, and the error code is stored in SD0.
 - When the module attempting access is not a special function module. (Error code: 2110)
 - When AJ71PT32-S3 control instructions cannot be used in the designated module. (Error code: 2112)
 - When the designated instruction name is illegal. (Error code: 4300)
 - When the number of AJ71PT32-S3 control instruction devices is illegal. (Error code: 4301)
 - When a non-designatable device is designated. (Error code: 4302)

Program Example

- (1) A program which stops transmission to remote terminal module No.1 of AJ71PT32-S3 installed in I/O number X/Y020-X/Y04F.

[Ladder mode]

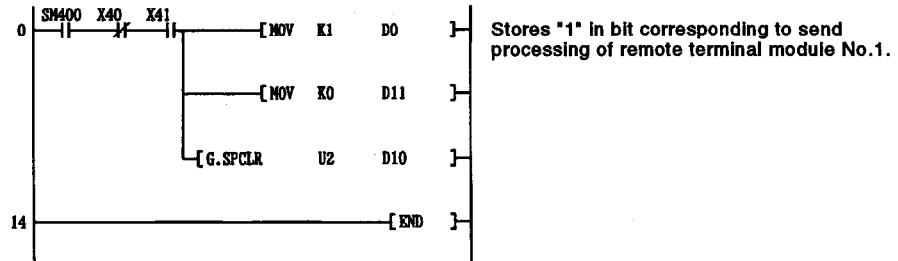

[List mode]

Step	Instruction	Device
0	LD	SM400
1	ANI	X40
2	AND	X41
3	MOV	K1 D0
5	MOV	K0 D11
7	G.SPCLR	U2 D10
14	END	

8. AJ71C21(S1) CONTROL INSTRUCTIONS

AJ71C21(S1) control instructions conduct data communications in the no-protocol mode with external devices connected to AJ71C21(S1). They are also instructions for reading/writing data to AJ71C21(S1) internal RAM memory.

The table below shows the AJ71C21(S1) control instructions.

Category	Instruction Name	Description	Refer to
Sending data	PRN2	Sends designated number of data to external device connected to RS-232C.	Section 8.1
	PRN4	Sends designated number of data to external device connected to RS-442.	
	PR2	Sends data up to 00H code to external device connected to RS-232C.	Section 8.2
	PR4	Sends data up to 00H code to external device connected to RS-442.	
Receiving data	INPUT2	Reads data received from external device connected to RS-232C.	Section 8.3
	INPUT4	Reads data received from external device connected to RS-442.	
Read RAM memory	GET	Reads data stored in AJ71C21-S1 RAM memory.	Section 8.4
Write to RAM memory	PUT	Writes data to AJ71C21-S1 RAM memory.	Section 8.5
Reading communication status	SPBUSY	Reads communications processing status, as well as execution status of RAM memory read/write processing by instructions.	Section 8.6
Forced stop of communication processing	SPCLR	Forcibly stops communication processing with external devices, as well as RAM memory read/write processing.	Section 8.7

POINTS

- (1) Note that when the module model name is not registered in the parameter setting, no error will occur even if AJ71C21(S1) control instructions are executed with respect to an AD61(S1). However, when these instructions are executed, the AD61(S1) may not operate normally.
- (2) GET instructions and PUT instructions cannot be used for AJ71C21.
(Due to lack of RAM memory)
When the module model name is registered, an error occurs and there is no operation.
When the module model name is not registered, instructions are executed but have no effect on control.

8.1 Sending Designated Number of Bytes of Data

Set Data	Usable Devices									
	Internal Device (System, User)		File Register	MELSECNET/10 Direct J:G:G		Special Function Module U:G:G	Index Register Zn	Constant		Other
	Bit	Word		Bit	Word			K, H	\$	
n	○	○		○			○	—	—	
(S)	—	○		—			—	○	—	
(D)	○	○		—			—	—	—	

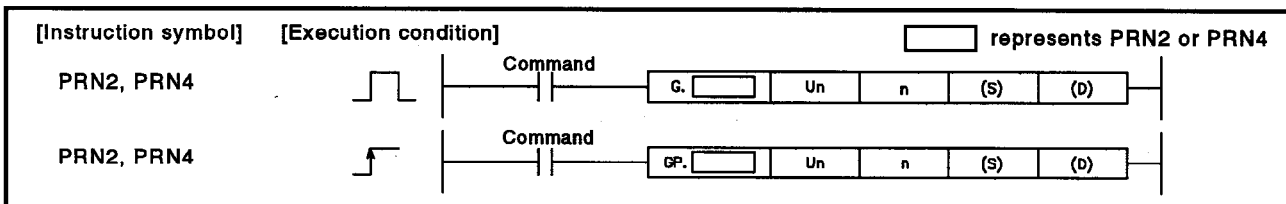

Set Data

Set Data	Description	Data Type
Un	Head I/O number of AJ71C21(S1)	16-bit binary
n	Number of send data (words or bytes)	
(S)	First device number of devices storing send data	Character string
(D)	Number of the bit device turning ON on completion of processing	Bit

Function

- Sends to the external device connected to AJ71C21(S1) n number of bytes/words of data stored from the device number designated at (S) onwards.
When send processing is completed, automatically turns ON the bit device designated at (D) after only 1 scan.
In the send processing the target interfaces differs according to the instructions used.
PRN2..... RS-232C interface
PRN4..... RS-422 interface

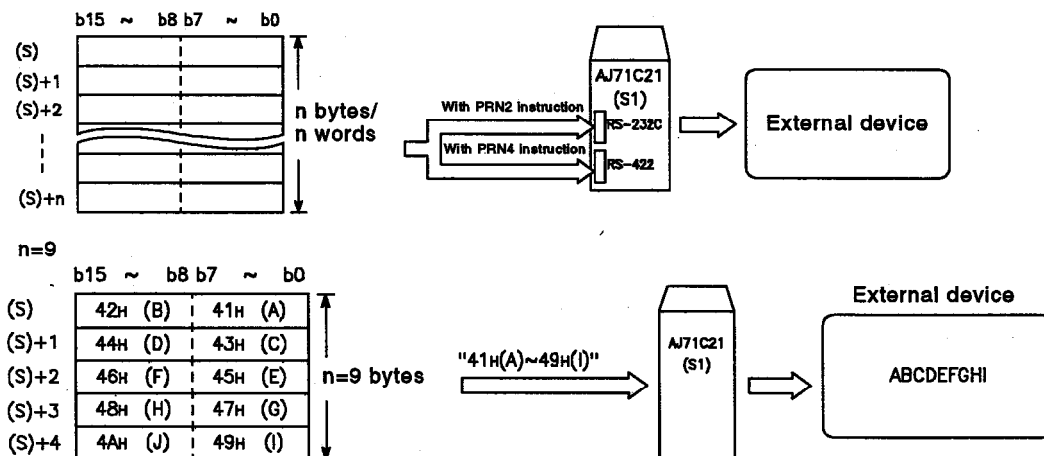

- (2) PRN2 and PRN4 instructions conduct ON/OFF control of AJ71C21(S1)X_(n+2), X_(n+7)(send completed), Y_(n+12), and Y_(n+17) (request to send) automatically by internal processing, and so these controls do not need to be conducted by the user.
- (3) The number of data designated at (n) can be set within the following ranges.
- Word unit.....1 to (no-protocol send buffer memory length set value - 1) words
- Byte unit.....1 to (no-protocol send buffer memory length set value - 1) x 2 bytes
- Set the following items when the AJ71C21(S1) data unit designation and buffer memory length are not used in the designations at power-on.
- No-protocol word/byte designation (Power-on: words)
 - No-protocol send buffer memory first address designation (Power-on: RS-232C...0H, RS-422...100H)
 - No-protocol send buffer memory length setting (Power-on: 80H)
- (4) The number of data designated at n differs according to the AJ71C21(S1) data unit designation (word or byte). Furthermore the send data set in (S) also differs depending on the word/byte unit.

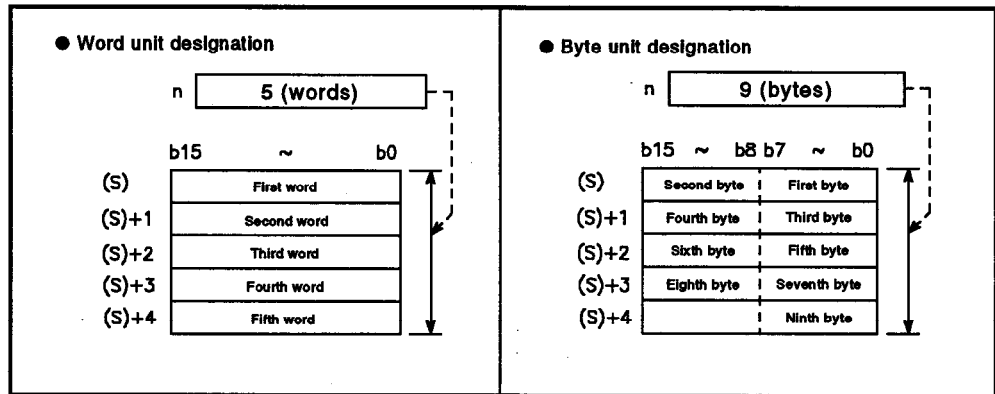

- (5) The bit device designated at (D) automatically turns ON on execution of the END instruction of the scan completing the send processing, and turns OFF at the END instruction of the next scan.
Used as PR2, PR4 instruction execution completion flag.

Operation Errors

- (1) In the following cases an operation error occurs, the error flag (SM0) turns ON, and the error code is stored in SD0.
- When the number of data designated at n exceeds the following range. (Error code: 4100)
 - Word unit.....1 to (no-protocol send buffer memory length
set value - 1) words
 - Byte unit.....1 to (no-protocol send buffer memory length
set value - 1) x 2 bytes
 - When the range of number of data designated at n from the device number designated at (S) onwards exceeds the last device number of the applicable device. (Error code: 4101)
 - When the number of characters in the character string designated at (S) is less than the number of characters (number of bytes) designated at n. (Error code: 4100)
 - When the module attempting access is not a special function module. (Error code: 2110)
 - When AJ71PT32-S3 control instructions cannot be used in the designated module. (Error code: 2112)
 - When the designated instruction name is illegal. (Error code: 4300)
 - When the number of AJ71PT32-S3 control instruction devices is illegal. (Error code: 4301)
 - When a non-designatable device is designated. (Error code: 4302)

Program Example

- (1) A program which, when X0 turns ON, sends the data of D0 to D4 in word units to the external device connected to the RS-232C interface of the AJ71C21(S1) installed at I/O numbers X/Y020 to X/Y03F is shown here. MO turns ON on completion of instruction execution.

[Ladder mode]

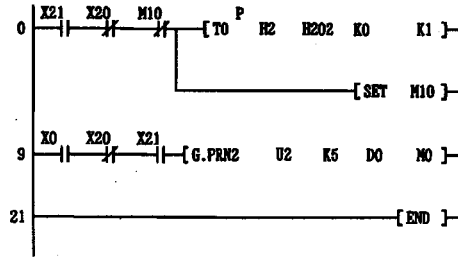

Sets once after CPU RUN in the communication data word unit designation.

[List mode]

Step	Instruction	Device
0	LD	X21
1	ANI	X20
2	ANI	M10
3	TOP	H2 H202 K0 K1
8	SET	M10
9	LD	X0
10	ANI	X20
11	AND	X21
12	G.PRN2	U2 K5 D0 MO
21	END	

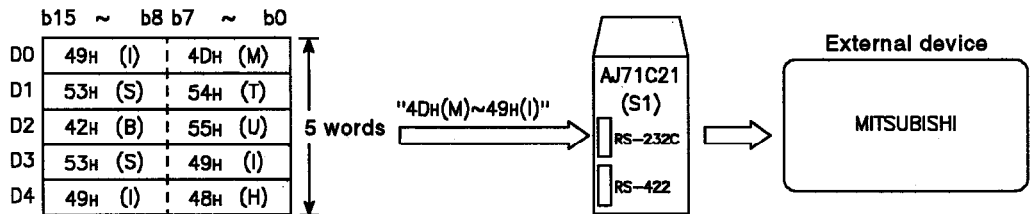

8.2 Data Send up to "00H" Code

Set Data	Usable Devices								
	Internal Device (System, User)		File Register	MELSECNET/10 Direct J-BUS		Special Function Module U-BUS	Index Register Zn	Constant \$	Other
	Bit	Word		Bit	Word				
(S)	—	○			○		○	—	
(D)	○	○			—		—	—	

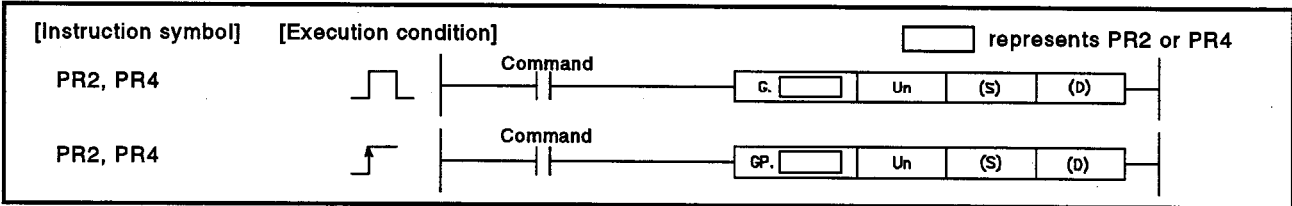

Set Data

Set Data	Description	Data Type
Un	Head I/O number of AJ71C21(S1)	16-bit binary
(S)	First device number of devices storing send data	Character string
(D)	Number of the bit device turning ON on completion of processing	Bit

Function

- Sends data from between the device number designated at (S) and the device number storing "00H", to the external device connected to the AJ71C21(S1).
When send processing is completed, automatically turns ON the bit device designated at (D) after only 1 scan.
In send processing, the target interfaces differ according to the instructions used.

PR2 RS-232C interface
PR4 RS-422 interface

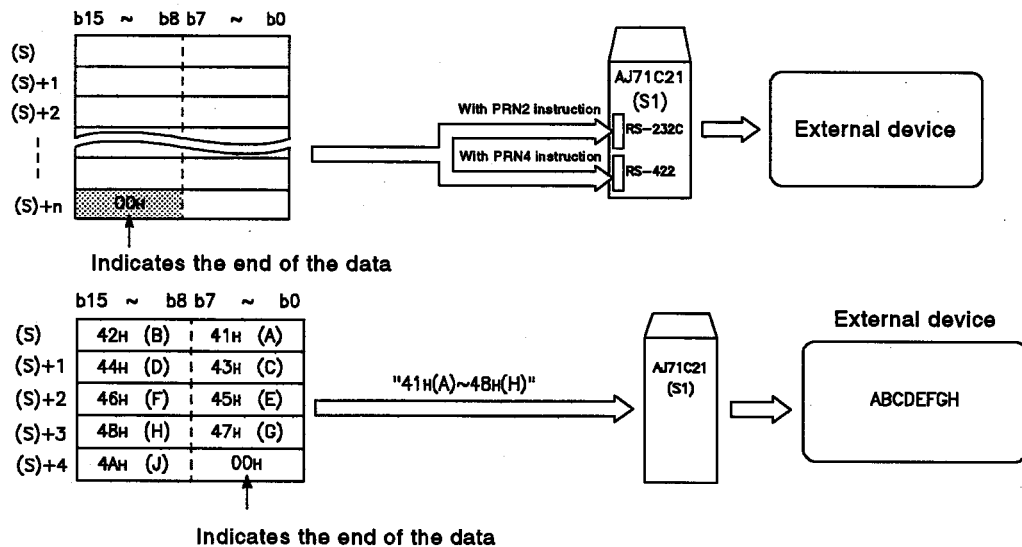

- (2) PR instructions conduct ON/OFF control of AJ71C21(S1) $X_{(n+2)}$, $X_{(n+7)}$ (send completed), $Y_{(n+2)}$, $Y_{(n+7)}$ (receive completed) automatically in internal processing, and so the control does not have to be conducted by the user.
- (3) "00H" cannot be set as data in the send data stored from the device designated at (S) onwards.
"00H" is the send data completed designation.
- (4) The number of data which can be sent at one time is shown below.
Word unit.....1 to (no-protocol send buffer memory length set value - 1) words
Byte unit.....1 to (no-protocol send buffer memory length set value - 1) x 2 bytes

Set the following items when the AJ71C21(S1) data unit designation and buffer memory length are not used in the settings at power-on.

- No-protocol word/byte designation (Power-on: words)
- No-protocol send buffer memory first address designation (Power-on: RS-232C...0H, RS-422...100H)
- No-protocol send buffer memory length setting (Power-on: 80H)

- (5) The send data set in (S) differs depending on the AJ71C21(S1) data unit designation (word or byte).

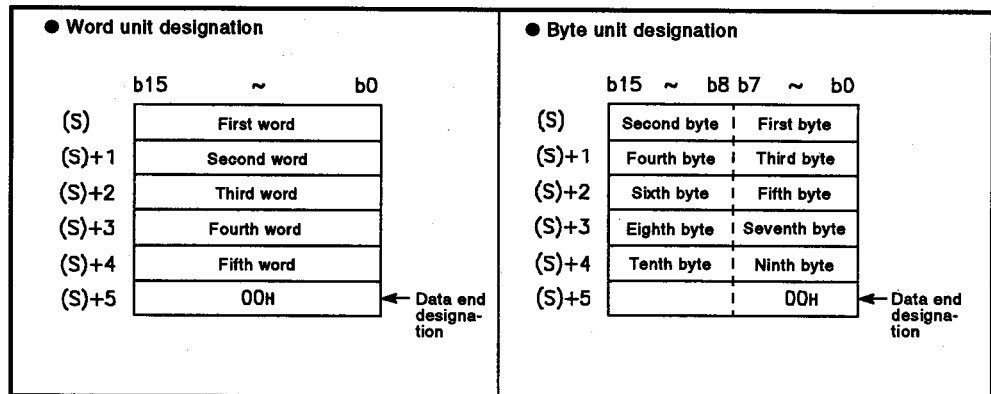

- (6) The bit device designated at (D) automatically turns ON on execution of the END instruction of the scan completing the transmission processing, and turns OFF at the END instruction of the next scan.
Used as PR2, PR4 instruction execution completion flag.

Operation Errors

- (1) In the following cases an operation error occurs, the error flag (SM0) turns ON, and the error code is stored in SD0.
 - When "00H" is not stored from between the device number designated at (S) onwards and the last device number of the applicable device. (Error code: 4100)
 - When the number of send data is outside the following range. (Error code: 4100)
 - Word unit.....1 to (no-protocol send buffer memory length set value - 1) words
 - Byte unit.....1 to (no-protocol send buffer memory length set value - 1) x 2 bytes
 - When the module attempting access is not a special function module. (Error code: 2110)
 - When AJ71PT32-S3 control instructions cannot be used in the designated module. (Error code: 2112)
 - When the designated instruction name is illegal. (Error code: 4300)
 - When the number of AJ71PT32-S3 control instruction devices is illegal. (Error code: 4301)
 - When a non-designatable device is designated. (Error code: 4302)

Program Example

- (1) A program which, when X0 turns ON, sends data in word units from the data stored in D0 to data up to 00H, to the external device connected to RS-232C interface of the AJ71C21(S1) installed at I/O numbers X/Y020 to X/Y03F is shown here. MO turns ON on completion of instruction execution.

[Ladder mode]

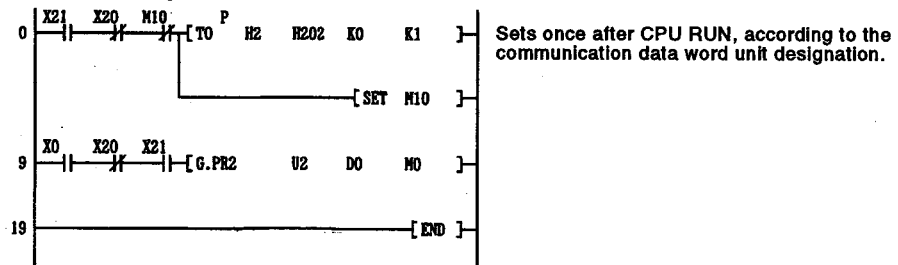

[List mode]

Step	Instruction	Device
0	LD	X21
1	ANI	X20
2	ANI	M10
3	TOP	H2 H202 K0 K1
8	SET	M10
9	LD	X0
10	ANI	X20
11	AND	X21
12	G.PR2	U2 D0 M0
19	END	

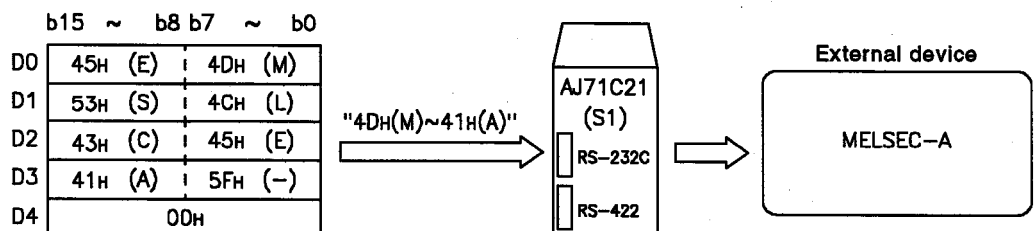

8.3 Receiving Data

Set Data	Usable Devices								
	Internal Device (System, User)		File Register	MELSECNET/10 Direct I/O		Special Function Module UO:AG:U	Index Register Zn	Constant K, H	Other U
	Bit	Word		Bit	Word				
n	—	○			—		—		
(D1)	—	○			○		—		
(D2)	○	○			—		—		

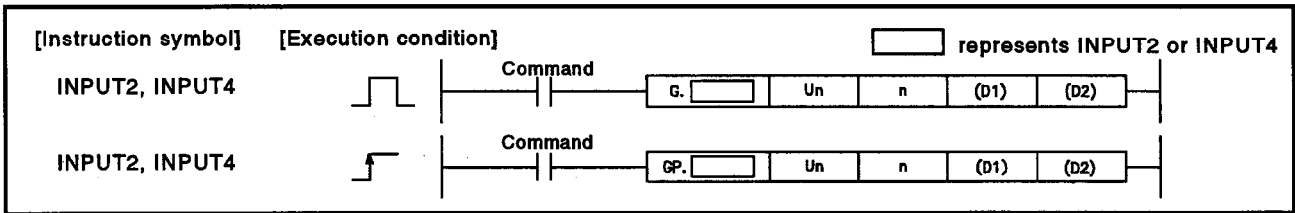

Set Data

Set Data	Description	Data Type
Un	Head I/O number of AJ71C21(S1)	16-bit binary
n	Permissible number of received data, and number of received data	
(D1)	Head number of device storing received data	Character string
(E2)	Number of the bit device turning ON on completion of processing	Bit

Function

- Receives data from the external device connected to AJ71C21(S1) within the permissible range of data designated at n, and stores it from the device number designated at (D1) onwards. When receive processing is completed, automatically turns ON bit device designated at (D2) after only 1 scan.

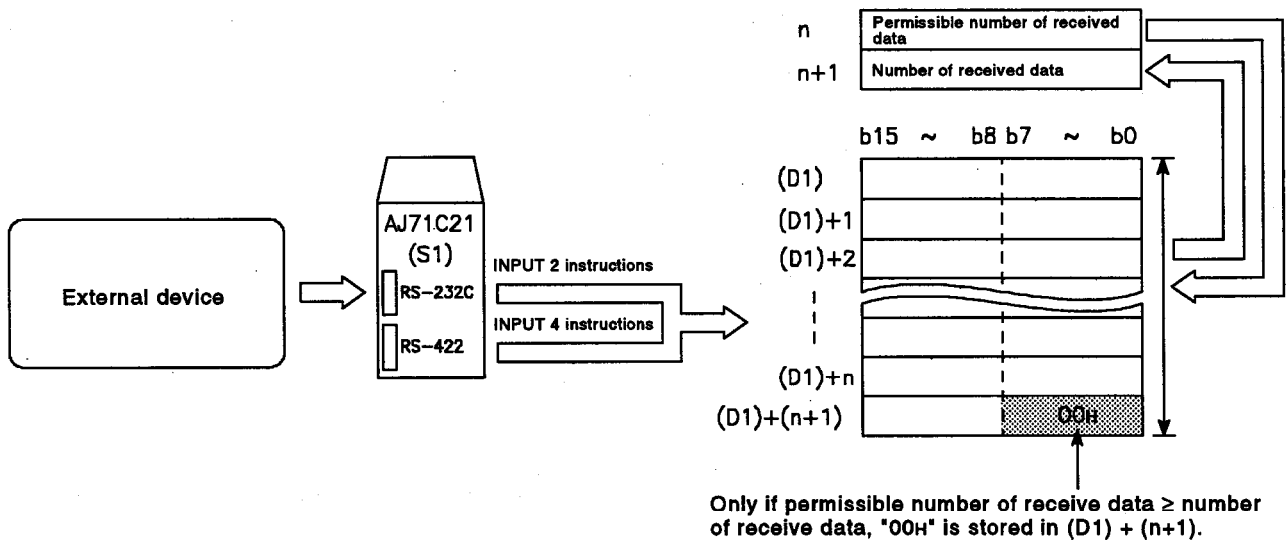

POINTS

- (1) The G(P).INPUT command cannot be made into a pulse.
- (2) Execute G(P).INPUT when I/O signal read request is ON.

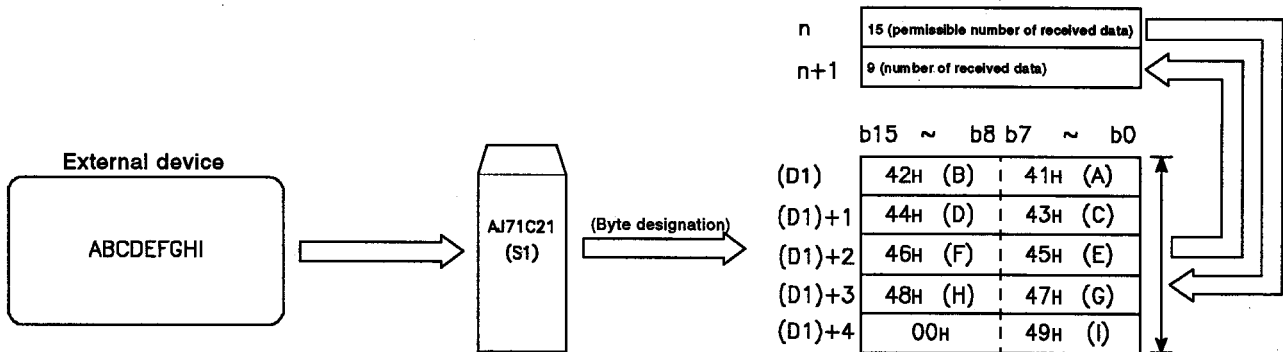

- (2) INPUT 2 and INPUT 4 instructions automatically conduct ON/OFF control of AJ71C21(S1) X(n+3), X(n+8) (request to read received data), Y(n+3), Y(n+8) (received data read completed) by internal processing, and so the control does not need to be conducted by the user.
- (3) The number of data that can be received by one receive processing is as shown below.

Word unit.....1 to (no-protocol receive buffer memory length set value - 1) words
 Byte unit.....1 to (no-protocol receive buffer memory length set value - 1) x 2 bytes

Set the following items when the AJ71C21(S1) data unit designation and buffer memory length are not used in the settings at power-on.

- No-protocol word/byte designation (Power-on: words)
- No-protocol receive buffer memory first address designation (Power-on: RS-232C...0H, RS-422...100H)
- No-protocol receive buffer memory length designation (Power-on: 80H)

- (4) The permissible number of received data designated at n1 is a setting to secure the device range for storing received data, and the data storage destination is the number of points designated at n1 starting from the device number designated at (D1). The actual number of received data is automatically stored in n+1.

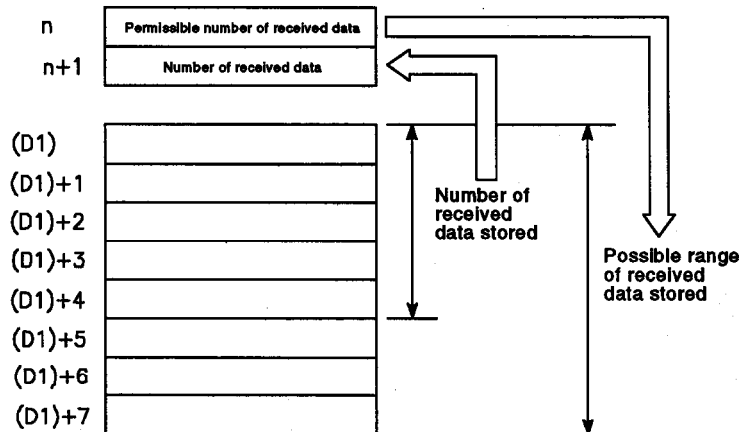

- (5) When the number of data actually received is larger than the permissible number of received data designated at n, only the permissible number of received data is stored, and the remaining received data is discarded.
- (6) The n and n+1 set value and stored value unit differ according to the AJ71C21(S1) data unit designation (word or byte).
The data stored in (D1) also differs according to whether word or byte units are designated.

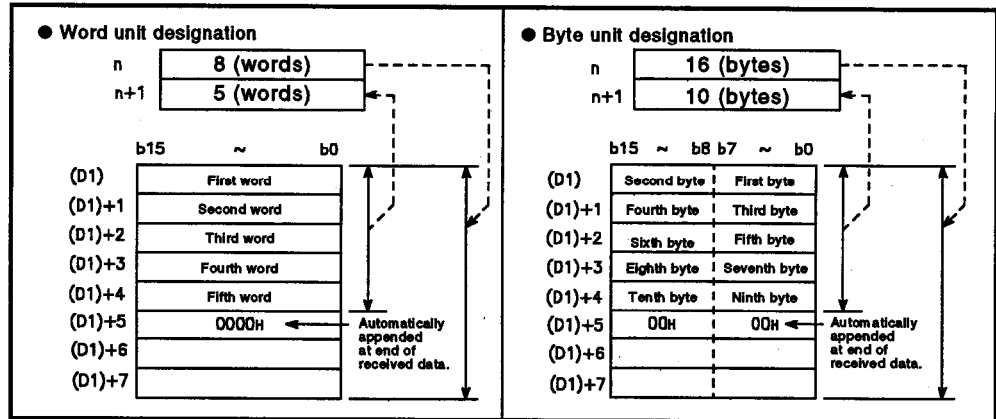

- (7) In byte unit designation, depending on whether the received data is odd or even numbered, the "00H" code added to the end of the received data is stored as below.
Received data is an odd number.....Stored in the higher bytes of the last device number storing received data.
Received data is an even number.....Stored in the device number immediately following the last device number storing received data.

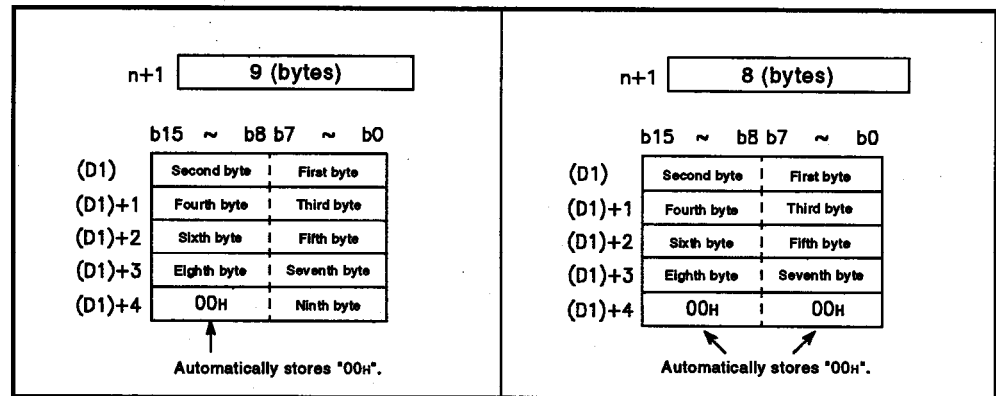

- (8) When the number of received data is higher than the permissible number of received data, the "00H" code which is added to the end of the received data is stored in the device number immediately following the device numbers of the permissible number of received data.

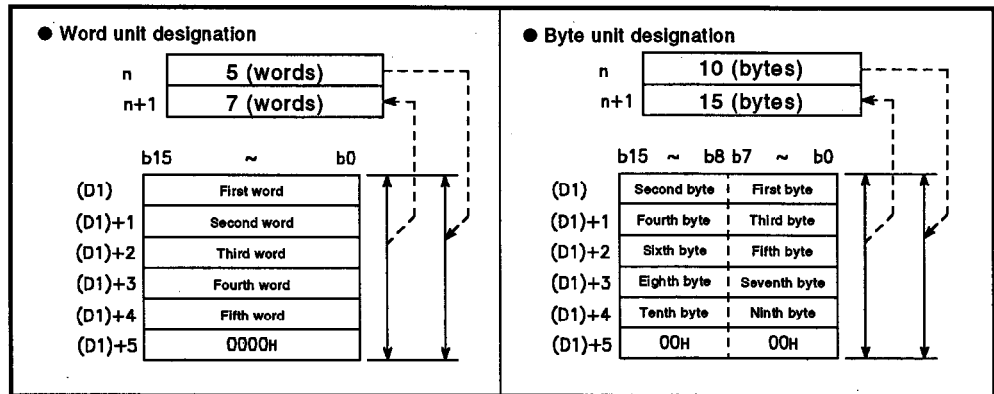

- (9) The bit device designated at (D2) automatically turns ON on execution of the END instruction of the scan completing the receive processing, and turns OFF at the END instruction of the next scan. Used as INPUT 2 and INPUT 4 execution completion flag.

Operation Errors

- (1) In the following cases an operation error occurs, the error flag (SM0) turns ON, and the error code is stored in SD0.
- When the range of the number of data designated at n, starting from the device number designated at (D), exceeds the last device number of the applicable device. (Error code: 4101)
 - When the module attempting access is not a special function module. (Error code: 2110)
 - When AJ71PT32-S3 control instructions cannot be used with the designated module. (Error code: 2112)
 - When the designated instruction name is illegal. (Error code: 4300)
 - When the number of AJ71PT32-S3 control instruction devices is illegal. (Error code: 4301)
 - When a non-designatable device is designated. (Error code: 4302)

Program Example

- (1) A program which, when X0 turns ON, receives 5 words of data from an external device connected to the RS-232C interface of the AJ71C21(S1) installed at I/O numbers X/Y020 to X/Y03F, and stores the data to D0 to D4, is shown here. MO turns ON on completion of instruction execution.

[Ladder mode]

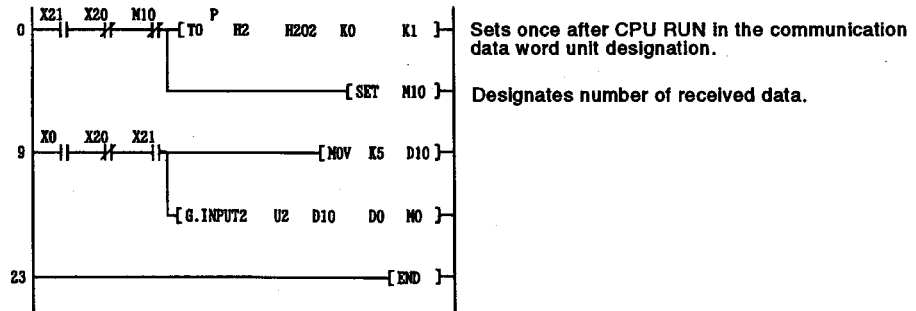

[List mode]

Step	Instruction	Device
0	LD	X21
1	ANI	X20
2	ANI	M10
3	TOP	H2
		H202
		K0
		K1
8	SET	M10
9	LD	X0
10	ANI	X20
11	AND	X21
12	MOV	K5
		D10
14	G.INPUT2	U2
		D10
		D0
		M0
23	END	

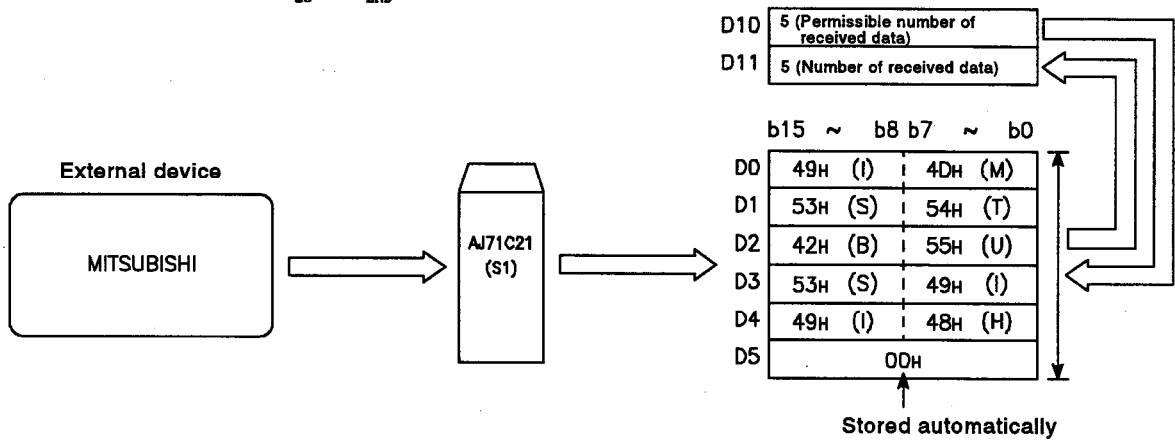

8.4 Read RAM Memory

Set Data	Usable Devices								
	Internal Device (System, User)		File Register	MELSECNET/10 Direct I/O		Special Function Module USAGE	Index Register Zn	Constant K, H	Other
	Bit	Word		Bit	Word				
(S)	—	○				—		—	
n	○	○				○		—	
(D1)	—	○				—		—	
(D2)	○	○				—		—	

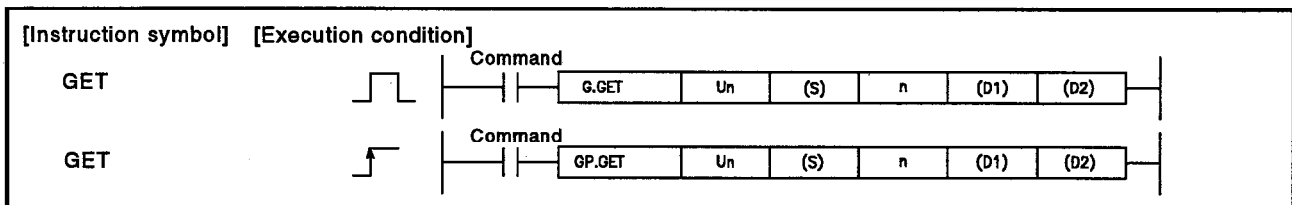

Set Data

Set Data	Description	Data Type
Un	Head I/O number of AJ71C21(S1)	16-bit binary
(S)	First address number of RAM memory storing read data	
n	Number of words of data to be read	
(D1)	First number of device storing data to be read	Device name
(D2)	Number of the bit device turning ON on completion of processing	Bit

Function

- Reads n words of data from the AJ71C21(S1) RAM memory area address number designated at (S), and stores data from the device number designated at (D1) onwards. When read processing is completed, automatically turns ON the bit device designated at (D2) after only one scan.

RAM number	Designated address	
0	0H 7FFH	RAM0
1	0H 7FFH	RAM1
2	0H 7FFH	RAM2
⋮	⋮	⋮
79	0H 7FFH	RAM79

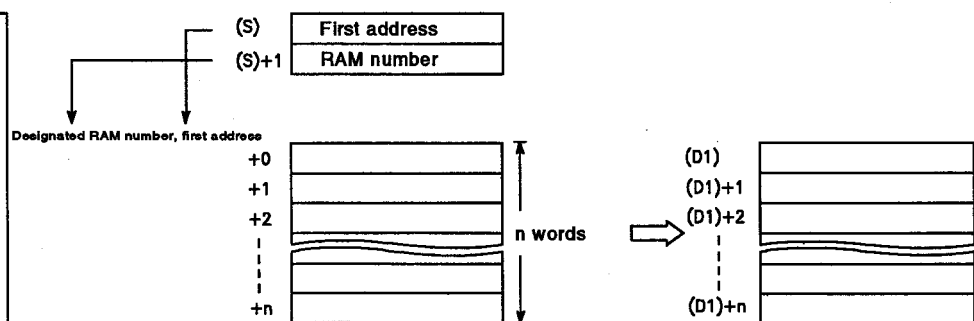

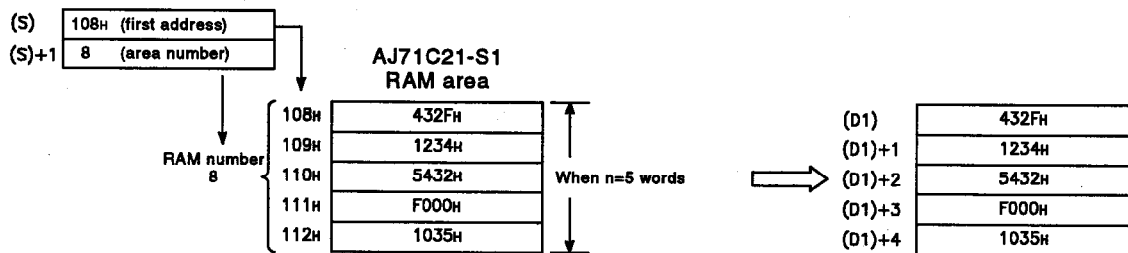

- (2) When the RAM memory is read with a GET instruction, ON/OFF control of AJ71C21(S1) $X_{(n+D)}$ (request to read RAM), and $Y_{(n+10)}$ (RAM read completed) are automatically conducted by internal processing, and so do not need to be conducted by the user.
- (3) The first address number designated at (S) is within the range "0 to 7FFH".
- (4) The RAM number designated at (S)+1 is within the range "0 to 79".
- (5) The number of words designated at n is within the range "1 to 2048". However, reading from multiple areas is not possible.
- (6) The bit device designated at (D2) automatically turns ON on execution of the END instruction of the scan completing the read processing, and turns OFF at the END instruction of the next scan.
Used as a GET instructions execution completion flag.

Operation Error

- (1) In the following cases an operation error occurs, the error flag (SM0) turns ON, and the error code is stored in SD0.
 - When the designated module is AJ71C21. (Error code: 2112)
 - When the address number designated at (S) exceeds the range 0 to 7FFH. (Error code: 4100)
 - When the area number designated at (S+1) exceeds the range 0 to 79. (Error code: 4100)
 - (For the AJ71C21-S2, when the area number exceeds the range 0 to 191.)
 - When the number of words designated at n exceeds the range 1 to 2048. (Error code: 4100)
 - When the range of the number of words designated at n, starting from the first device number designated at (D1), exceeds 7FFH. (Error code: 4100)
 - When the range of the number of words designated at n, starting from the first device number designated at (D1), exceeds the last device number of the applicable device. (Error code: 4101)
 - When the module attempting access is not a special function module. (Error code: 2110)
 - When AJ71PT32-S3 control instructions cannot be used with the designated module. (Error code: 2112)
 - When the designated instruction name is illegal. (Error code: 4300)
 - When the number of AJ71PT32-S3 control instruction devices is illegal. (Error code: 4301)
 - When a non-designatable device is designated. (Error code: 4302)

Program Example

- (1) A program which, when X0 turns ON, stores data from addresses 0H to 4H of RAM number 1 of the AJ71C21(S1) installed at I/O numbers X/Y020 to X/Y03F, to D0 to D4, is shown here.
 MO turns ON on completion of instruction execution.

[Ladder mode]

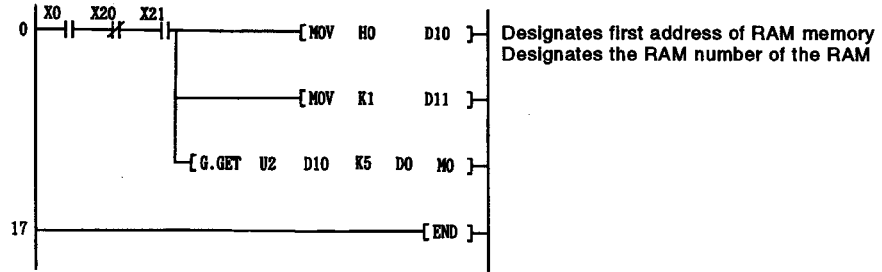

[List mode]

Step	Instruction	Device
0	LD	X0
1	ANI	X20
2	AND	X21
3	MOV	H0 D10
5	MOV	K1 D11
7	G.GET	U2 D10 K5 D0 MO
17	END	

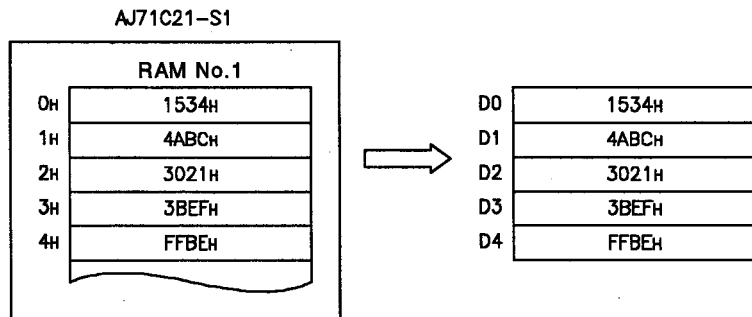

8.5 Write to RAM Memory

Set Data	Usable Devices								
	Internal Device (System, User)		File Register	MELSECNET/10 Direct I/O		Special Function Module (SFM)	Index Register Zn	Constant K, H	Other
	Bit	Word		Bit	Word				
(S1)	—	○				—		—	
n	○	○				○		—	
(S2)	—	○				—		—	
(D)	○	○				—		—	

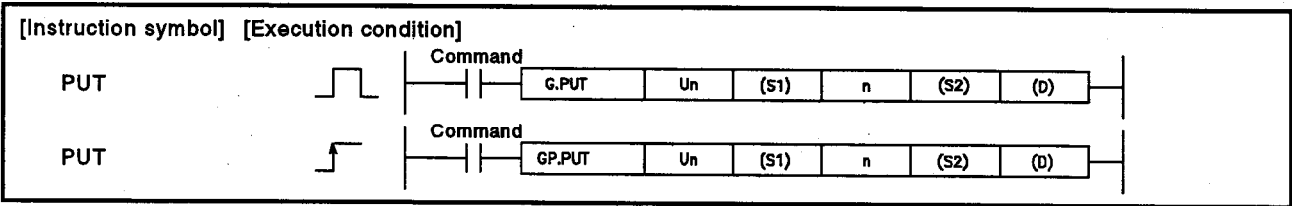

Set Data

Set Data	Description	Data Type
Un	First I/O number of AJ71C21(S1)	16-bit binary
(S1)	First address number of RAM memory storing write data	
n	Number of words of write data	
(S2)	First device number of the devices to store the written data	Device name
(D)	Number of the bit device turning ON on completion of processing	Bit

Function

- Writes n-words of data, stored from the device number designated at (S2) onwards, to AJ71C21(S1) RAM memory addresses starting from the address number designated by (S1).

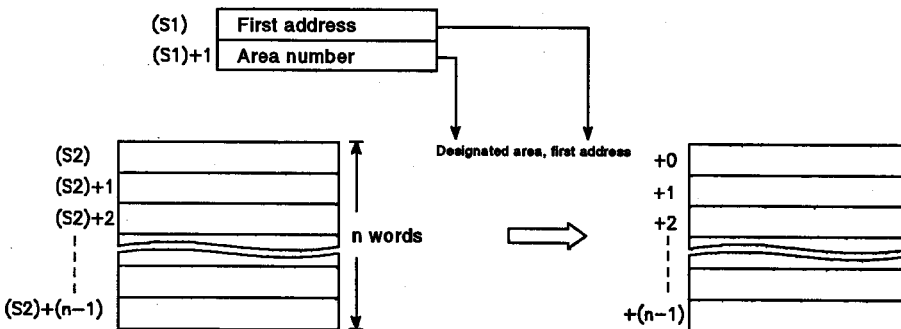

RAM number	Designated address	
0	0H 7FFH	RAM0
1	0H 7FFH	RAM1
2	0H 7FFH	RAM2
⋮	⋮	⋮
79	0H 7FFH	RAM79

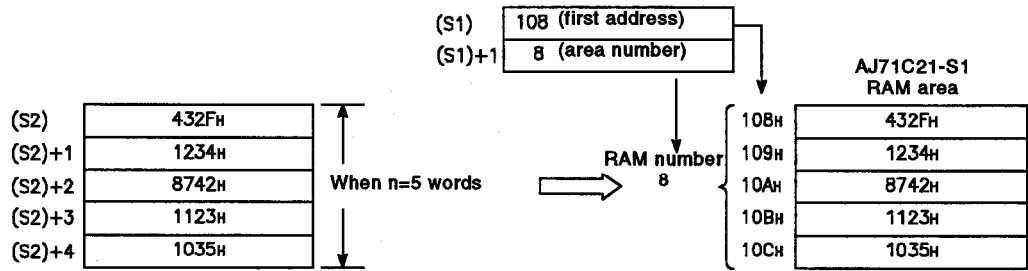

- (2) When data is written to RAM memory by a PUT instruction, the ON/OFF control of AJ71C21(S1) X_(n+c)(RAM write completed), Y_(n+1c)(request to write to RAM) is automatically conducted by internal processing, and so does not need to be conducted by the user.
- (3) The first address number designated at (S1) is within the range "0 to 7FFH".
- (4) The area number designated at (S1)+1 is within the range "0 to 79".
- (5) The number of words designated at n is within the range "1 to 2048". However, writing to multiple areas is not possible.
- (6) The bit devices designated at (D) automatically turns ON on execution of the END instructions of the scan completing write processing, and turns OFF at the END instruction of the next scan.
Used as PUT instructions execution completion flag.

Operation Errors

- (1) In the following cases an operation error occurs, the error flag (SM0) turns ON, and the error code is stored in SD0.
 - When the designated module is AJ71C21. (Error code: 2112)
 - When the address number designated at (S1) exceeds the range 0 to 7FFH. (Error code: 4100)
 - When the area number designated at (S1)+1 exceeds the range 0 to 79. (Error code: 4100)
 - When the number of words designated at n exceeds the range 1 to 2048. (Error code: 4100)
 - When the number of words designated at n, starting from the first device number designated at (S1), exceeds 7FFH. (Error code: 4100)
 - When the range of the number of words designated at n, starting from the first device number designated at (S2), exceeds the last device number of the applicable device. (Error code: 4000)
 - When AJ71PT32-S3 control instructions cannot be used in the designated module. (Error code: 2112)
 - When the designated instruction name is illegal. (Error code: 4300)
 - When the number of AJ71PT32-S3 control instruction devices is illegal. (Error code: 4301)
 - When a non-designatable device is designated. (Error code: 4302)

Program Example

- (1) A program which, when X0 turns ON, writes the data of D0 to D4 to addresses 0H to 4H of RAM number 1 of the AJ71C21(S1) installed at I/O numbers X/Y020 to X/Y03F is shown here.
MO turns ON on completion of instruction execution.

[Ladder mode]

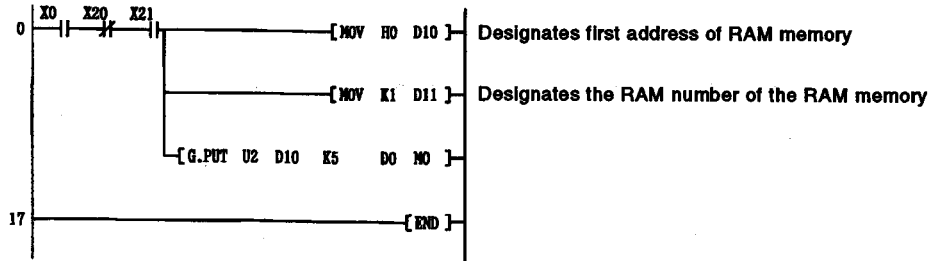

[List mode]

Step	Instruction	Device
0	LD	X0
1	ANI	X20
2	AND	X21
3	MOV	H0 D10
5	MOV	K1 D11
7	G.PUT	U2 D10 K5 D0 MO
17	END	

D0	1534H
D1	4ABCH
D2	3021H
D3	3BEFH
D4	FFBEH

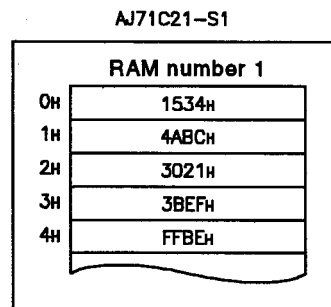

8.6 Reading Communication Status

Set Data	Usable Devices								
	Internal Device (System, User)		File Register	MELSECNET/10 Direct J-BUS		Special Function Module (SFM)	Index Register Zn	Constant	Other
	Bit	Word		Bit	Word				
(D)	0							—	

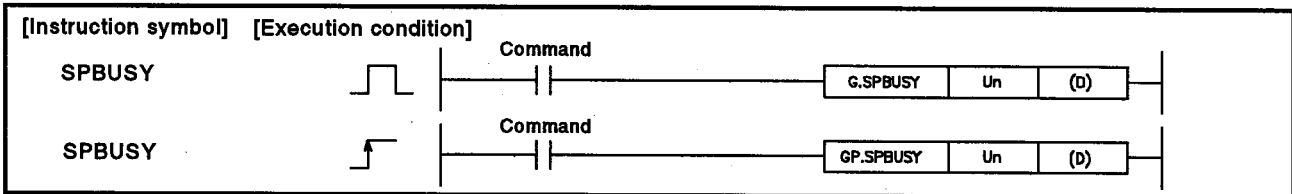

Set Data

Set Data	Description	Data Type
Un	Head I/O number of the AJ71C21(S1)	Device name
(D)	Device number storing read communication status	16-bit binary

Function

- Reads the execution status of the following instructions of AJ71C21(S1), and stores it to the device designated at (D).
 - PRN2, PRN4, PR2, PR4 instructions (data send instructions)
 - INPUT2, INPUT4 instructions (data receive instructions)
 - GET, PUT instructions (instructions for reading/writing RAM memory data)
- For the execution status stored in (D), "1" is stored in the corresponding bit when by any instruction is started, and "0" is stored when the processing is completed. Processing completed of instruction is the point when the instruction completion flag (designated bit device) moves from ON to OFF.

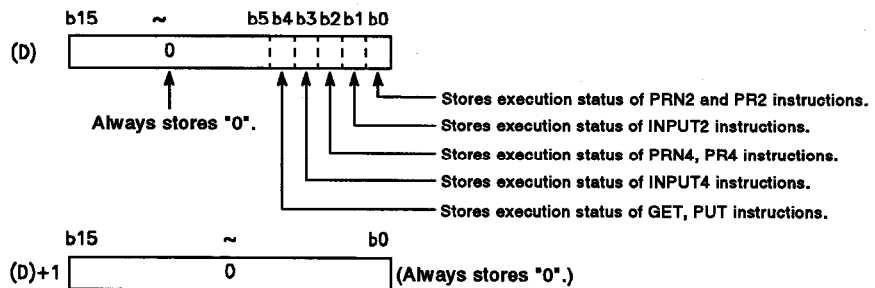

POINTS

- The G(P).SPBUSY command cannot be made into a pulse.
- Execute the G(P).SPBUSY when I/O signal read request is ON.

Operation Errors

- (1) In the following cases an operation error occurs, the error flag (SM0) turns ON, and the error code is stored in SD0.
 - When the module attempting access is not a special function module. (Error code: 2110)
 - When AJ71PT32-S3 control instructions cannot be used in the designated module. (Error code: 2112)
 - When the designated instruction name is illegal. (Error code: 4300)
 - When the number of AJ71PT32-S3 control instruction devices is illegal. (Error code: 4301)
 - When a non-designatable device is designated. (Error code: 4302)

Program Example

- (1) A program which turns M10 ON when the PR2 instructions or PRN2 instruction is executed at the AJ71C21(S1) installed at I/O numbers X/Y020 to X/Y03F is shown here.

[Ladder mode]

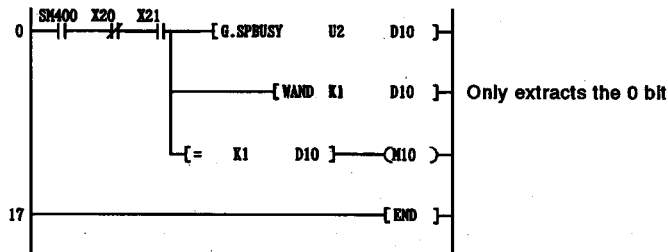

[List mode]

Step	Instruction	Device
0	LD	SM400
1	ANI	X20
2	AND	X21
3	G.SPBUSY	U2 D10
10	WAND	K1 D10
13	AND=	K1 D10
16	OUT	M10
17	END	

8.7 Forced Stop of Communication Processing

Set Data	Usable Devices								
	Internal Device (System, User)		File Register	MELSECNET/10 Direct JCOMM		Special Function Module UCOMM	Index Register Zn	Constant	Other
	Bit	Word		Bit	Word				
(S)	0							—	

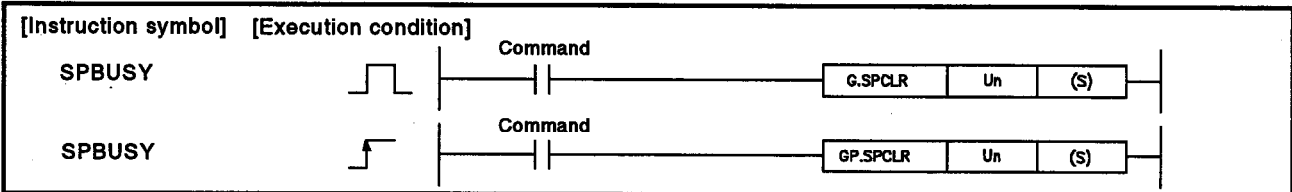

Set Data

Set Data	Description	Data Type
Un	Head I/O number of the AJ71C21 (S1)	16-bit binary
(S)	First device number of the devices storing the data subject to the stop.	Device name

Function

- (1) Forcibly cancels AJ71C21(S1) communication processing (i.e. processing by PR(N)2, PR(N)4 and INPUT instructions) or accessing RAM memory (processing by GET and PUT instructions).
- (2) The cancel processing is set in (S). The cancel setting is conducted by setting "1" in the applicable device for cancel processing.

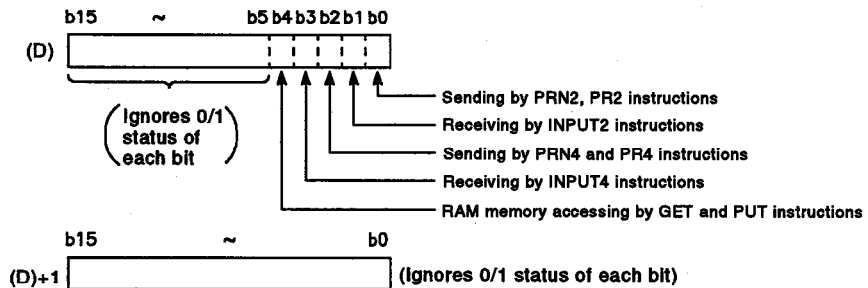

- (3) When processing is cancelled, the completion flag (designated bit device) for the instruction corresponding to the cancellation does not turn ON.

Operation Errors

- (1) In the following cases an operation error occurs, the error flag (SM0) turns ON, and the error code is stored in SD0.
- When the module attempting access is not a special function module. (Error code: 2110)
 - When AJ71PT32-S3 control instructions cannot be used with the designated module. (Error code: 2112)
 - When the designated instruction name is illegal. (Error code: 4300)
 - When the number of AJ71PT32-S3 control instruction devices is illegal. (Error code: 4301)
 - When a non-designatable device is designated. (Error code: 4302)

Program Example

- (1) A program which, when X0 turns ON, stops PR2 instructions or PRN2 instructions which are being executed at the AJ71C21(S1) installed at I/O numbers X/Y020 to X/Y03F, is shown here.

[Ladder mode]

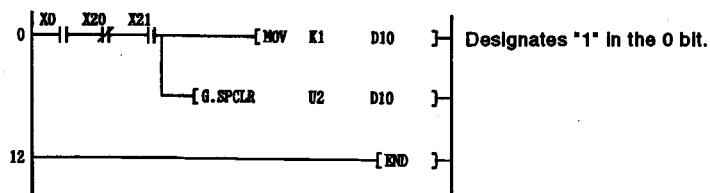

[List mode]

Step	Instruction	Device
0	LD	X0
1	ANI	X20
2	AND	X21
3	MOV	K1 D10
5	G.SPCLR	U2 D10
12	END	

9. COMPUTER LINK MODULE CONTROL INSTRUCTIONS

MELSEC-QnA

9. COMPUTER LINK MODULE CONTROL INSTRUCTIONS

Computer link module control instructions are instructions for conducting data communications in no-protocol mode with external devices connected to AJ71C24(S3, S6, S8) and AJ71UC24.

In this section AJ71C24(S3, S6, S8) and AJ71UC24 are collectively referred to as "computer link module".
(However this excludes descriptions requiring the model name)

The following table shows computer link module control instructions.

Category	Instruction Name	Description	Refer to
Data send	PRN	Sends designated number of data to connected external device.	Section 9.1
	PR	Sends data up to 00H code to connected external device.	Section 9.2
Data receive	INPUT	Reads data received from external device.	Section 9.3
Read communications status	SPBUSY	Reads communication processing status by instructions.	Section 9.4
Forced stop of communication processing	SPCLR	Forcibly stops communication processing with external device.	Section 9.5

POINT

If instructions are executed with respect to a computer link module without the model name being registered in parameter setting, the word/byte designation and communication buffer memory area setting are processed as if set with the following contents.

- No-protocol word/byte designation..... Only words allowable
- No-protocol send buffer memory area..... Only 0H-7FH allowable
- No-protocol receive buffer memory area... Only 80H-FFH allowable
- Received data length..... Up to CR, LF code, or 127 words

Accordingly, when the following settings are made for the computer link module, the QnACPU writes and reads data ignoring the settings for the computer link module, and so malfunctioning may occur.

- No-protocol receive END code designation (address 100)
- No-protocol word/byte designation (address 103)
- No-protocol send buffer memory first address designation (address 104)
- No-protocol send buffer memory length designation (address 105)
- No-protocol receive buffer memory first address designation (address 106)
- No-protocol receive buffer memory length designation (address 107)
- No-protocol receive END number of data designation (address 108)

The above buffer memory set values are valid when model name registration has been performed.

9.1 No-Protocol Mode Data Send of Designated Number of Bytes

Set Data	Usable Devices									
	Internal Device (System, User)		File Register	MELSECNET/10 Direct I/O		Special Function Module (SFM)	Index Register Zn	Constant		Other
	Bit	Word		Bit	Word			K, H	\$	
(n)	○	○			○			○	—	—
(S)	—	○			—			—	○	—
(D)	○	○			—			—	—	—

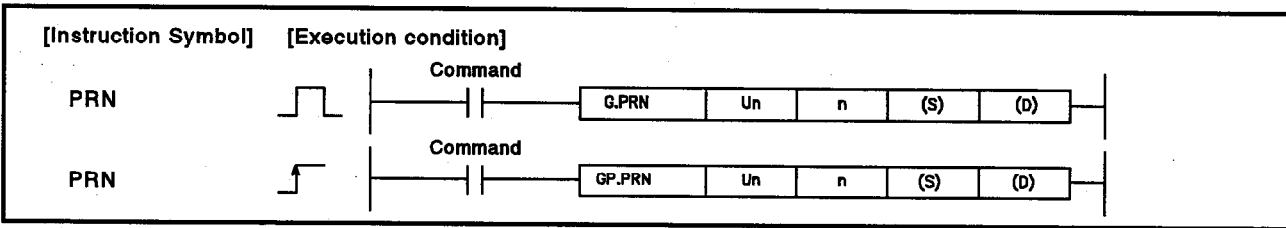

Set Data

Set Data	Description	Data Type
Un	Head I/O number of computer link module	16-bit binary
n	Number of send data (words or bytes)	
(S)	First device number of devices storing send data	Character string
(D)	Number of the bit device turning ON on completion of processing	Bit

Function

- Sends n number of bytes/words data stored in the device number designated from (S) onwards to the external device connected to the computer link module. When send processing is completed, the bit device designated at (D) automatically turns ON after only 1 scan.

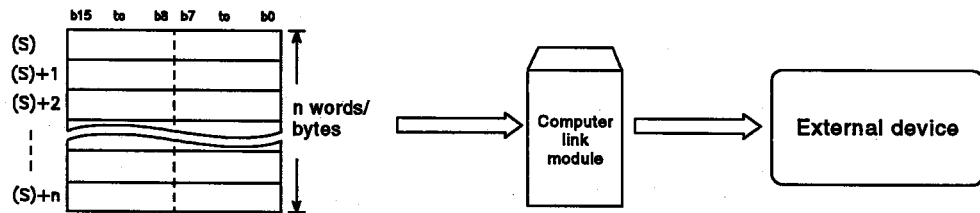

For n=9

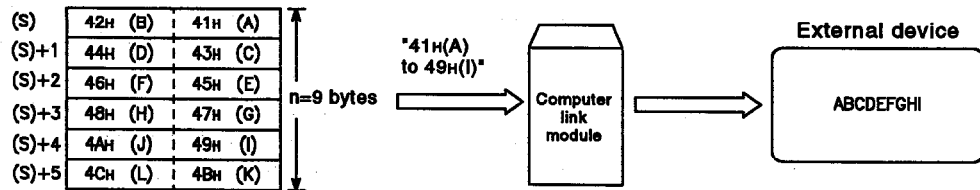

- (2) PRN instructions automatically conduct the ON/OFF control of computer link module $X_{(n+0)}$ (send completed) and $Y_{(n+10)}$ (send request) by internal processing, and so control does not need to be conducted by the user.
- (3) The number of data designated at n can be set within the following range.

AJ71C24.....	1 to 127 words
AJ71C24-S3/S6/S8, AJ71UC24	Word units..... 1 to (no-protocol send buffer memory length set value - 1) words
	Byte units..... 1 to (no-protocol send buffer memory length set value - 1) x 2 bytes

Set following items when the computer link module data unit designation and buffer memory length are not used in power-on setting.

- No-protocol word/byte designation (Power-on: word)
- No-protocol send buffer memory first address designation (Power-on: 0H)
- No-protocol send buffer memory length designation (Power-on: 80H)

- (4) The unit of the number of data designated at n differs depending on the data unit designation (word or byte) of the computer link module. Send data set at (S) also differs depending whether the designated unit is words or bytes.

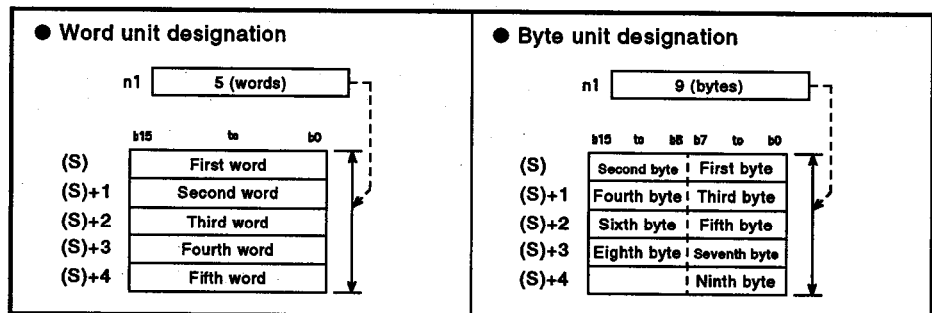

- (5) The bit device designated at (D) automatically turns ON when the END instructions are run for the scan completing the send processing, and turns OFF at the END instruction of the next scan. Used as PRN instructions execution completion flag.

Operation Errors

- (1) In the following cases an operation error occurs, the error flag (SM0) turns ON, and the error code is stored in SD0.
 - When the number of data designated at n exceeds the following range. (Error code: 4100)

AJ71C24..... 1 to 127 words

AJ71C24-S3/S6/S8,
AJ71UC24

Word units..... 1 to (no-protocol send buffer memory length set value - 1) words
Byte units..... 1 to (no-protocol send buffer memory length set value - 1) x 2 bytes

- When the range of the number of data designated at n, starting from the device number designated at (S), exceeds the last device number of the applicable device. (Error code: 4101)
- When the number of characters in the character string designated at (S) is smaller than the number of characters (number of bytes) designated at n. (Error code: 4100)
- When the module attempting access is not a special function module. (Error code: 2110)
- When computer link module control instructions cannot be used in the designated module. (Error code: 2112)
- When the designated instruction name is illegal. (Error code: 4300)
- When the number of computer link module control instruction devices is illegal. (Error code: 4301)
- When a non-designatable device is designated. (Error code: 4302)

Program Example

- (1) A program which, when X0 turns ON, transmits the data of D0-D4 in word units to the external device connected to the AJ71C24-S3 installed at I/O numbers X/Y020-X/Y03F is shown here. MO turns ON on completion of instruction execution.

[Ladder mode]

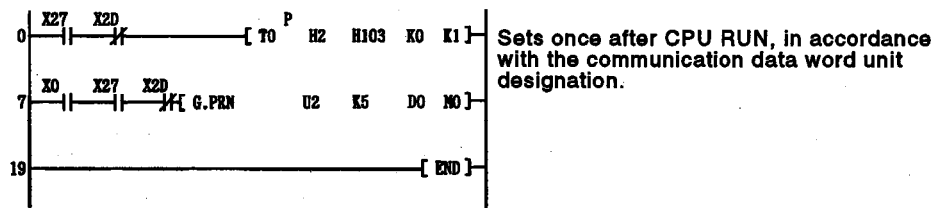

[List mode]

Step	Instruction	Device
0	LD	X27
1	ANI	X2D
2	TOP	H2
		H103
		K0
		K1
7	LD	X0
8	AND	X27
9	ANI	X2D
10	G.PRN	U2
		K5
		D0
		M3
19	END	

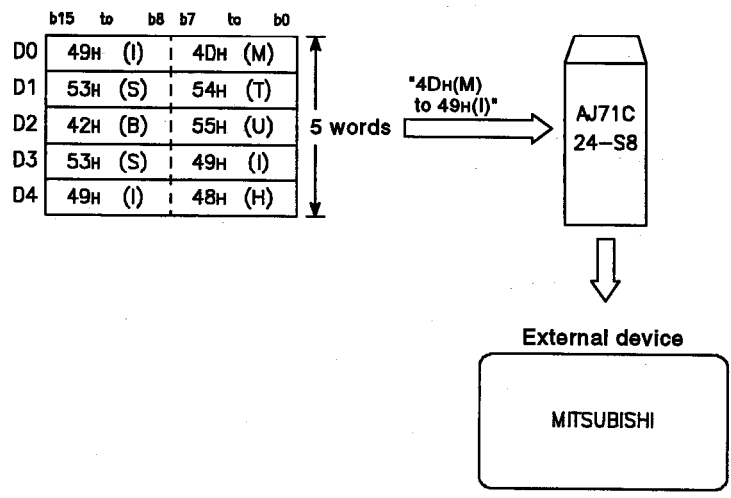

9.2 No-Protocol Mode Data Send Up until "00H" Code

Set Data	Usable Devices								
	Internal Device (System, User)		File Register	MELSECNET/10 Direct LINK		Special Function Module LINK	Index Register Zn	Constant	Other
	Bit	Word		Bit	Word			\$	
(S)	—	○					○	—	
(D)	○	○					—	—	

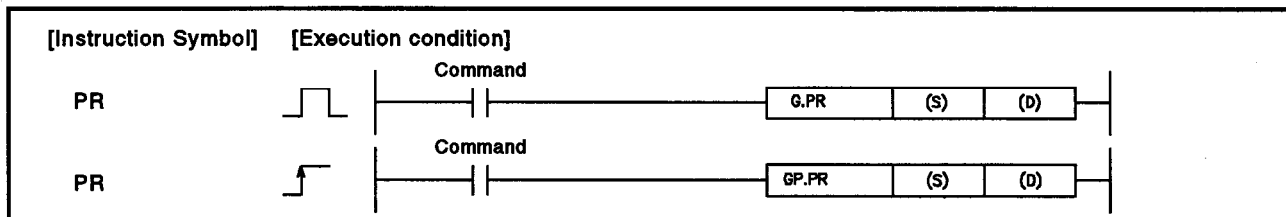

Set Data

Set Data	Description	Data Type
Un	Head I/O number of computer link module	16-bit binary
(S)	First device number of devices storing send data	Character string
(D)	Bit device turning ON at processing completion	Bit

Function

- (1) Sends the data from between the device number designated at (S) to the device number storing "00H", to the external device connected to the computer link module. When send processing is completed, the bit device designated at (D) automatically turns ON after only 1 scan.

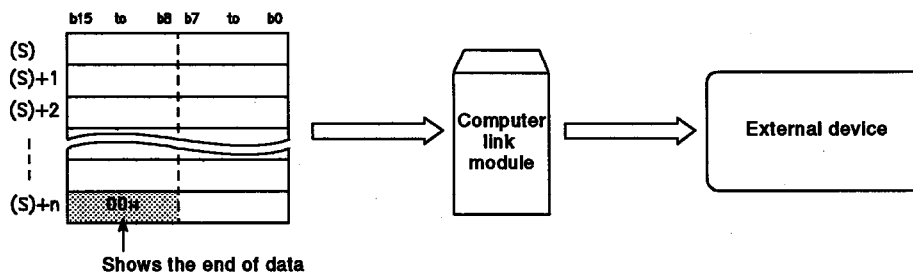

[Example:]

The following situation arises when "ABCDEFGH" is stored from the device designated at (S) onwards.

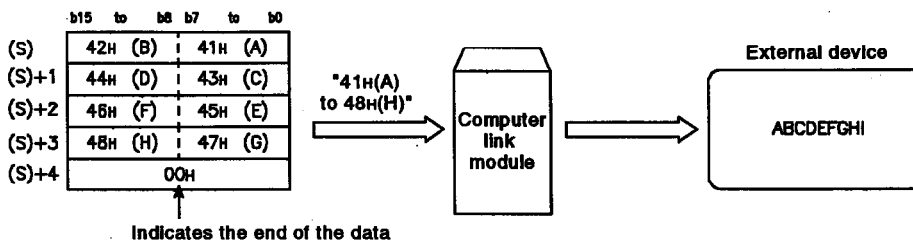

- (2) PR instructions automatically conduct ON/OFF control of computer link module $X_{(n+0)}$ (send completed) and $Y_{(n+10)}$ (request to send) in internal processing, and so this control does not need to be conducted by user.
- (3) "00H" cannot be set as data in the send data stored from the device number designated at (S) onwards. "00H" is the send data END designation.
- (4) The number of data that can be sent at one time is shown below.

AJ71C24.....	1 to 127 words					
AJ71C24-S3/S6/S8, AJ71UC24	<table border="0"> <tr> <td rowspan="2" style="font-size: 3em; vertical-align: middle;">{</td> <td>Word units.....</td> <td>1 to (no-protocol send buffer memory length set value - 1) words</td> </tr> <tr> <td>Byte units.....</td> <td>1 to (no-protocol send buffer memory length set value - 1) x 2 bytes</td> </tr> </table>	{	Word units.....	1 to (no-protocol send buffer memory length set value - 1) words	Byte units.....	1 to (no-protocol send buffer memory length set value - 1) x 2 bytes
{	Word units.....		1 to (no-protocol send buffer memory length set value - 1) words			
	Byte units.....	1 to (no-protocol send buffer memory length set value - 1) x 2 bytes				

Set the following items when the computer link module data unit designation and buffer memory length are not used in power-on setting.

- No-protocol word/byte designation (Power-on: word)
- No-protocol send buffer memory first address designation (Power-on: 0H)
- No-protocol send buffer memory length designation (Power-on: 80H)

- (5) The send data set in (S) differs according to the computer link module data unit designation (word or unit).

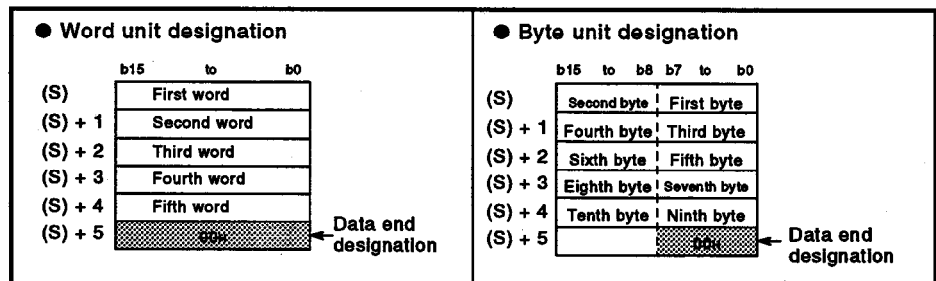

- (6) The bit device designated at (D) automatically turns ON when the END instruction is executed in the scan completing the send processing, and turns OFF at the END instruction of the next scan. Used as PR instruction execution completion flag.

Operation Errors

- (1) In the following cases an operation error occurs, the error flag (SM0) turns ON, and the error code is stored in SD0.
 - When "00H" is not stored between the device number designated at (S) and the last device number of the applicable device. (Error code: 4100)
 - When the number of send data is outside the following range. (Error code: 4100)

AJ71C24.....	1 to 127 words	{	Word units..... 1 to (no-protocol send buffer memory length set value - 1) words		
AJ71C24-S3/S6/S8, AJ71UC24	1 to 127 words			{	Byte units..... 1 to (no-protocol send buffer memory length set value - 1) x 2 bytes
 - When the module attempting access is not a special function module. (Error code: 2110)
 - When computer link module control instructions cannot be used with the designated module. (Error code: 2112)
 - When the designated instruction name is illegal. (Error code: 4300)
 - When the number of computer link module control instruction devices is illegal. (Error code: 4301)
 - When a non-designatable device is designated. (Error code: 4302)

Program Example

- (1) A program which, when X0 turns ON, sends data in word units from the data stored in D0 to 00H, to an external device connected to the AJ71C24-S3 installed at I/O numbers X/Y020-X/Y03F is shown here. MO turns ON on completion of instruction execution.

[Ladder mode]

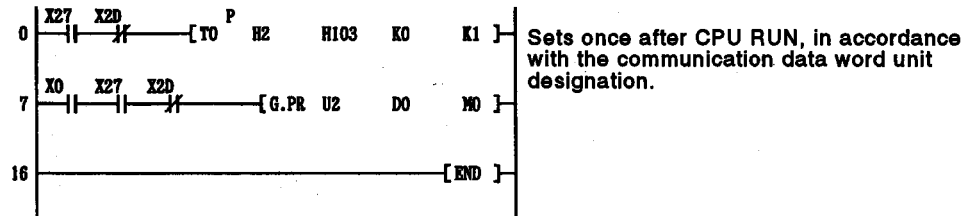

[List mode]

Step	Instruction	Device
0	LD	X27
1	ANI	X2D
2	TOP	H2 H103 KO K1
7	LD	X0
8	AND	X27
9	ANI	X2D
10	G.PR	U2 D0 MO
16	END	

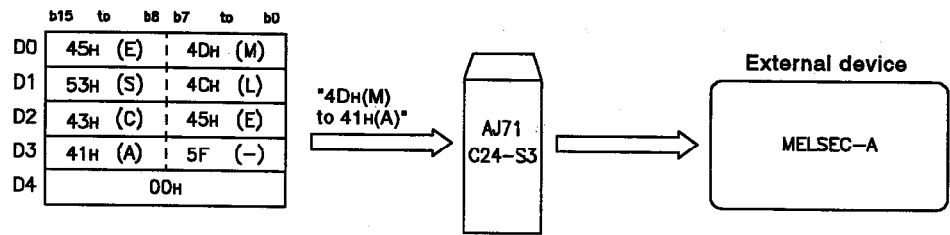

9.3 No-Protocol Mode Data Receive

Set Data	Usable Devices								
	Internal Device (System, User)		File Register	MELSECNET/10 Direct I/O		Special Function Module (SFM)	Index Register Zn	Constant	Other
	Bit	Word		Bit	Word				
n	—	○		—		—		—	
(D1)	—	○		—		—		—	
(D2)	○	○		○		—		—	

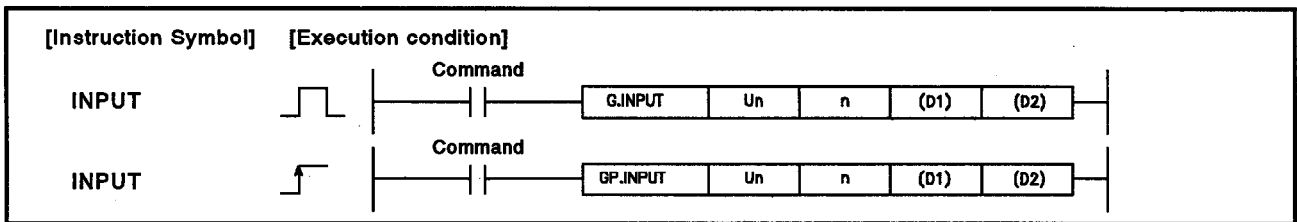

Set Data

Set Data	Description	Data Type
Un	Head I/O number of computer link module	16-bit binary
n	Permissible number of received data, and number of received data	
(D1)	Head number of device storing received data	Device name
(D2)	Number of the bit device turning ON on completion of processing	Bit

Function

- Receives data from the external device connected to the computer link module within the permissible range of data designated at n, and stores it from device number designated at (D1) onwards. On completion of receive processing, the bit device designated at (D1) is automatically turned ON for one scan only.

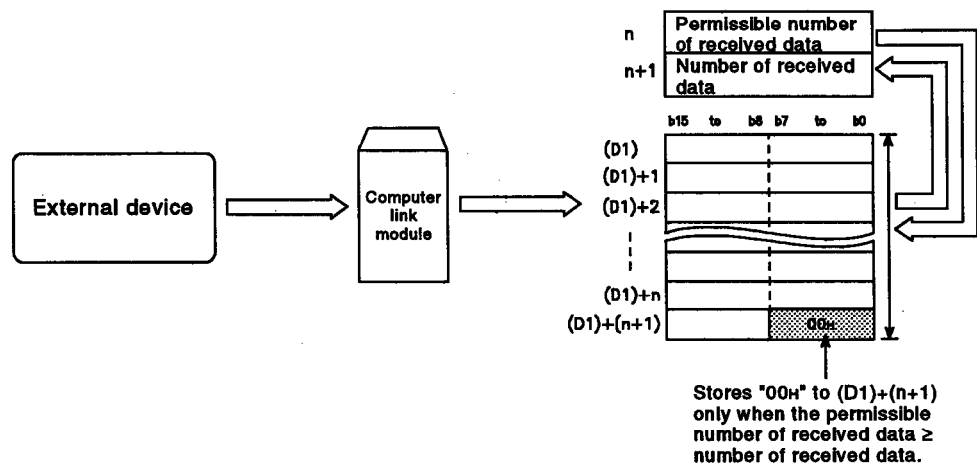

POINTS

- (1) The G(P).INPUT command cannot be made into a pulse.
- (2) Execute G(P).INPUT when I/O signal read request is ON.

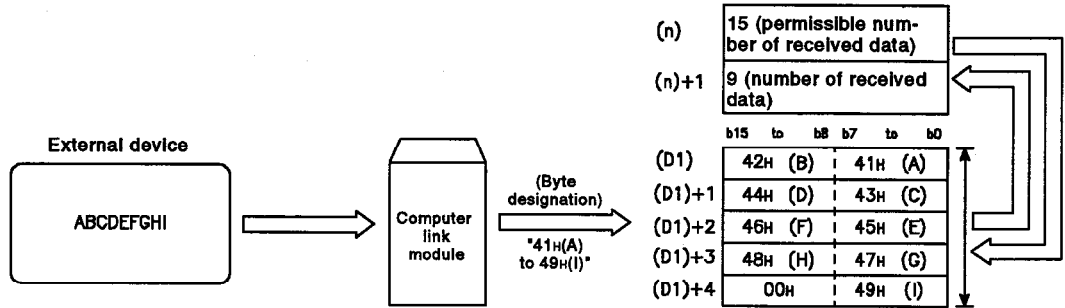

- (2) INPUT instructions automatically conduct ON/OFF control of the computer link module X_(n+1)(request to read received data) and Y_(n+11)(read completion of received data) in internal processing, and so this control does not need to be conducted by the user.
- (3) The number of data which can be received in one receive processing is as follows.

AJ71C24.....Maximum 127 words

AJ71C24-S3/S6/S8,
AJ71UC24

Word units..... Maximum (no-protocol receive buffer memory length set value - 1) words
 Byte units..... Maximum (no-protocol receive buffer memory length set value - 1) x 2 bytes

Set the following items when the computer link module data unit designation and buffer memory length are not used in power-on setting.

- No-protocol word/byte designation (Power-on: word)
- No-protocol send buffer memory first address designation (Power-on: 0H)
- No-protocol send buffer memory length designation (Power-on: 80H)

- (4) The permissible number of received data designated at n1 is a setting made to secure the range of devices for storing received data, and the data storage destination is the number of devices designated by n, starting from the device number designated at (D1). The number of data actually received is automatically stored in n+1.

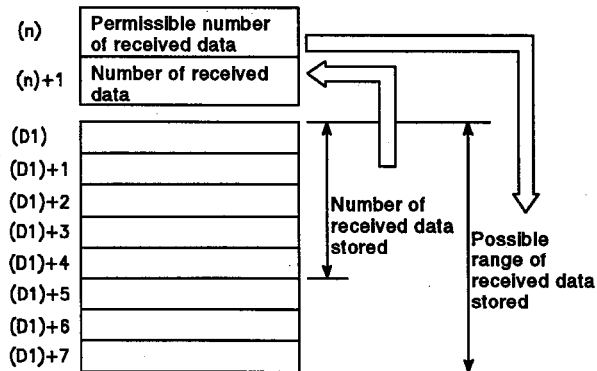

- (5) When the number of data actually received is higher than the permissible number of received data designated at n, only the permissible number of received data is stored, and the remaining received data is discarded.
- (6) n and n+1 set value and stored value units differ according to the computer link module data unit designation.
The data stored in (D1) also differs according to the unit (words or bytes).

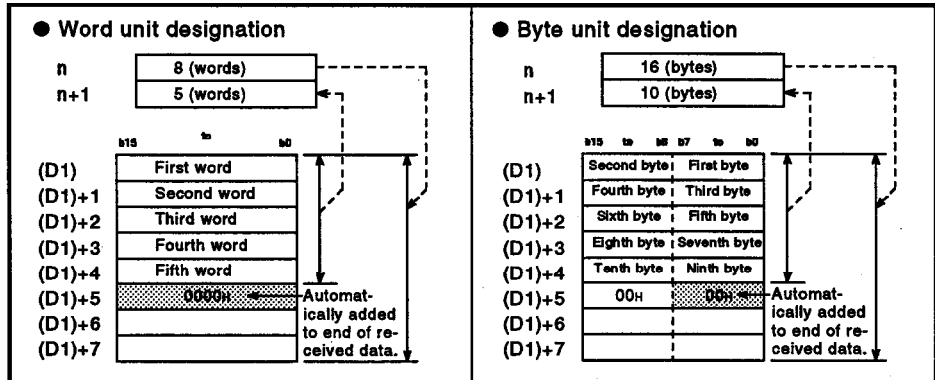

- (7) In byte unit designation, depending on whether the received data is odd or even numbered, the "00H" code added to the end of the received data is stored as below.
Received data is an odd number..... Stored in the higher bytes of the last device number storing received data.
Received data is an even number..... Stored in next device number of last device number storing received data.

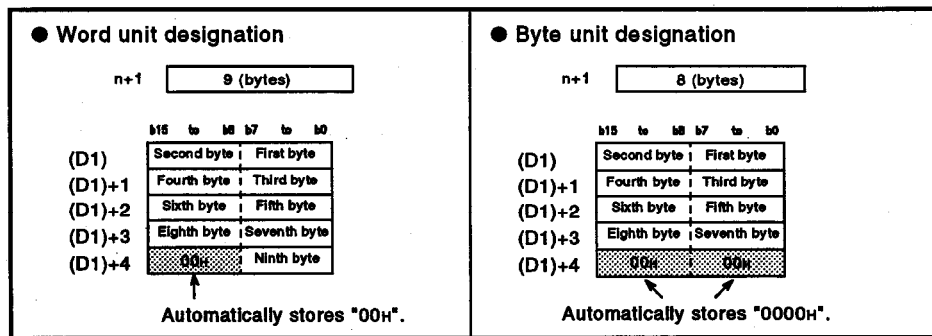

- (8) When the number of received data is larger than the permissible number of received data, the "00H" code added to the end of the received data is stored in the device number immediately following the device number of the range of permissible number of received data.

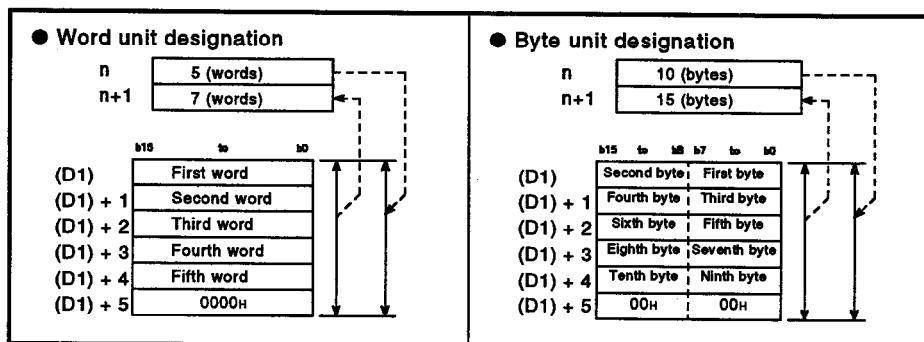

- (9) The bit device designated at (D2) automatically turns ON when the END instruction is executed in the scan completing the reception, and turns OFF at the END instructions of the next scan. Used as an execution completion flag for INPUT instructions.

Operation Errors

- (1) In the following cases an operation error occurs, the error flag (SM0) turns ON, and the error code is stored in SD0.
- When the range of the number of data designated at n, starting from the device number designated at (D), exceeds the last device number of the applicable device. (Error code: 4100)
 - When the module attempting access is not a special function module. (Error code: 2110)
 - When computer link module control instructions cannot be used in the designated module. (Error code: 2112)
 - When the designated instruction name is illegal. (Error code: 4300)
 - When the number of computer link module control instruction devices is illegal. (Error code: 4301)
 - When a non-designatable device is designated. (Error code: 4302)

Program Example

- (1) A program which, when X0 is ON, receives 5 words of data from the external device connected to the AJ71C24-S3 installed at I/O numbers X/Y020-X/Y03F, and stores the data to D0-D4, is shown here. MO turns ON on completion of instruction execution.

[Ladder mode]

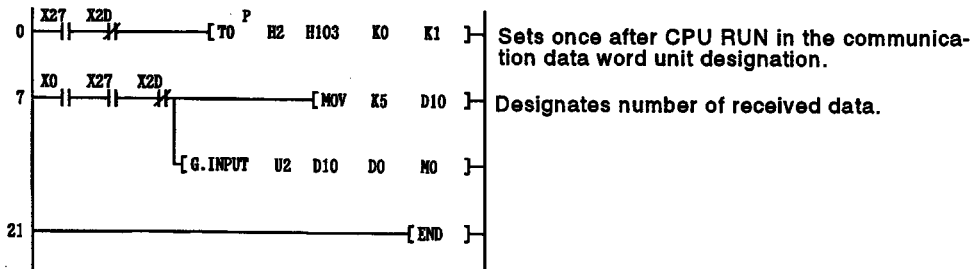

[List mode]

Step	Instruction	Device
0	LD	X27
1	ANI	X2D
2	TOP	R2 R103 K0 K1
7	LD	X0
8	AND	X27
9	ANI	X2D
10	MOV	K5
12	G.INPUT	D10 U2 D10 DO MO
21	END	

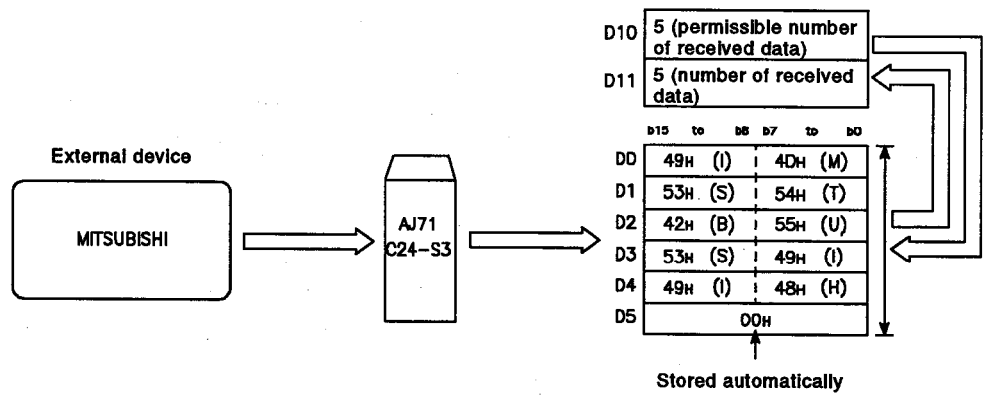

9.4 Reading Communication Status

Set Data	Usable Devices								
	Internal Device (System, User)		File Register	MELSECNET/10 Direct I/O		Special Function Module U/G/G	Index Register Zn	Constant	Other
	Bit	Word		Bit	Word				
(D)	0							—	

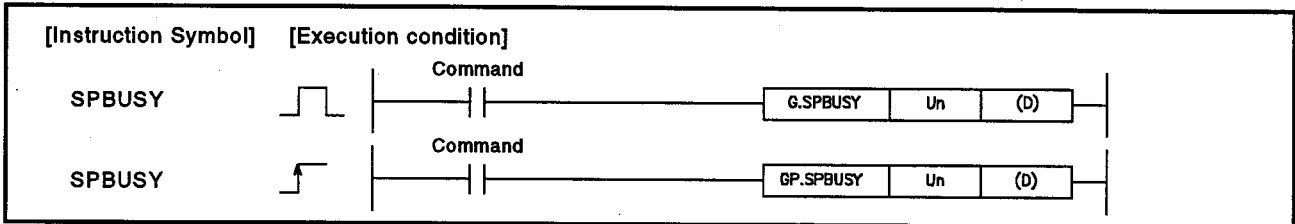

Set Data

Set Data	Description	Data Type
Un	Head I/O number of computer link module	16-bit binary
(D)	Device number storing read communication status	32-bit binary

Function

- Reads the execution status of the following instructions of the computer link module, and stores the status to the device designated at (D).
 - PRN, PR instructions (data send instructions)
 - INPUT instructions (data receive instructions)
- For the execution status stored in (D), "1" is stored in the corresponding bit at the start of processing, and "0" is stored when processing is completed. The completion of instruction processing is indicated by the instruction completion flag (designated bit device) turning from ON to OFF.

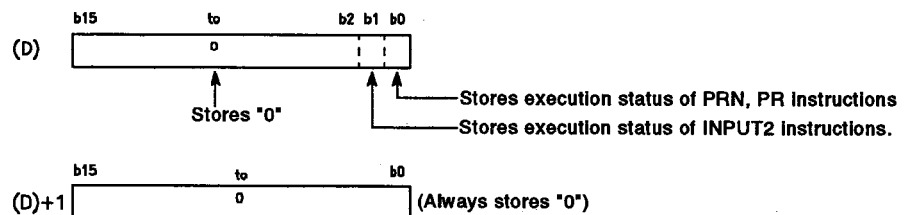

Operation Errors

- In the following cases an operation error occurs, the error flag (SM0) turns ON, and the error code is stored in SD0.
 - When the module attempting access is not a special function module. (Error code: 2110)
 - When computer link module control instructions cannot be used with the designated module. (Error code: 2112)
 - When the designated instruction name is illegal. (Error code: 4300)
 - When the number of computer link module control instruction devices is illegal. (Error code: 4301)
 - When a non-designatable device is designated. (Error code: 4302)

Program Example

- (1) A program which turns M10 ON when PR instructions are executed in AJ71C24-S3 installed in I/O number X/Y020-X/Y03F.

[Ladder mode]

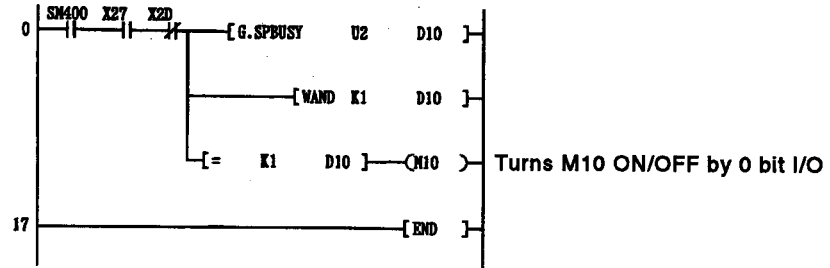

[List mode]

Step	Instruction	Device
0	LD	SM400
1	AND	X27
2	ANI	X2D
3	G.SPBUSY	U2 D10
10	WAND	K1 D10
13	AND=	K1 D10
16	OUT	M10
17	END	

9.5 Forced Cancellation of Communications Processing

Set Data	Usable Devices								
	Internal Device (System, User)		File Register	MELSECNET/10 Direct J-BUS		Special Function Module U-BUS	Index Register Zn	Constant	Other
	Bit	Word		Bit	Word				
(S)	0							—	

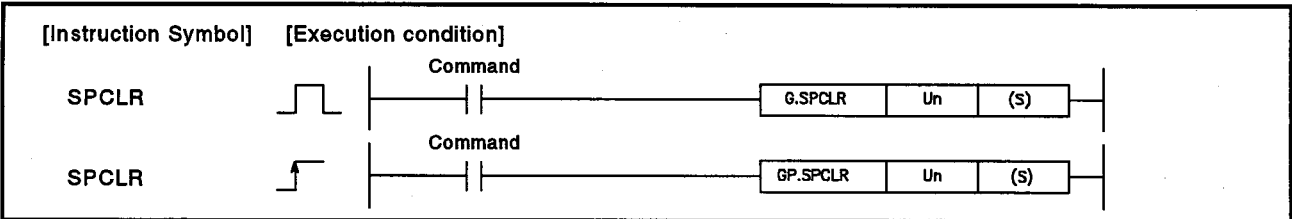

Set Data

Set Data	Description	Data Type
Un	Head I/O number of computer link module	16-bit binary
(S)	First device number of the devices storing the data designated for the stop	32-bit binary

Function

- (1) Forcibly cancels communication processing (processing by PRN, PR, INPUT instructions) of computer link module.
- (2) Setting of the cancel processing is conducted at (S). The cancel setting is made by setting "1" in the applicable device for cancel processing.

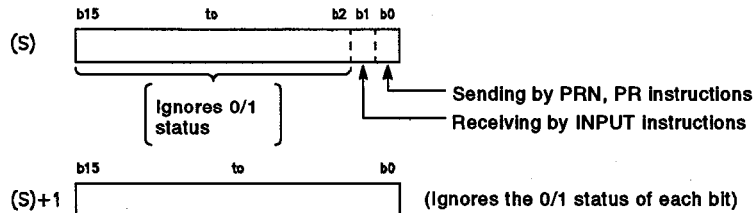

- (3) When processing is cancelled, the completion flag (designated bit device) for the instruction corresponding to the cancellation does not turn ON.

Operation Errors

- (1) In the following cases an operation error occurs, the error flag (SM0) turns ON, and the error code is stored in SD0.
 - When the module attempting access is not a special function module. (Error code: 2110)
 - When computer link module control instructions cannot be used in the designated module. (Error code: 2112)
 - When the designated instruction name is illegal. (Error code: 4300)
 - When the number of computer link module control instruction devices is illegal. (Error code: 4301)
 - When a non-designatable device is designated. (Error code: 4302)

Program Example

- (1) A program which cancels the PR or PRN instruction being executed at the AJ71C24-S3 installed at I/O numbers X/Y020-X/Y03F is shown here.

[Ladder mode]

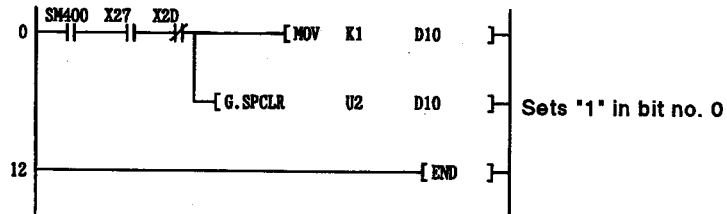

[List mode]

Step	Instruction	Device
0	LD	SM400
1	AND	X27
2	ANI	X2D
3	MOV	K1 D10
5	G.SPCLR	U2 D10
12	END	

10. AJ71QC24 CONTROL INSTRUCTIONS

AJ7QC24 instructions are instructions for conducting data communications between an AJ71QC24 and external devices connected to the AJ71QC24.

The following table shows AJ71QC24 instructions.

Category	Instruction Name	Description
Write user registration frame to EPROM	PUTE	Registers the user registration frame in EPROM, or deletes registered user registration frame.
Read user registration frame from EPROM	GETE	Reads the user registration frame registered in EPROM.
Data send by dedicated protocol on-demand function	ONDEMAND	Sends data in dedicated protocol by on-demand functions.
Designated number of data send in no-protocol protocol	OUTPUT	Sends designated number of data in no-protocol protocol.
Data send in no-protocol protocol Data send in accordance with schedule table	PRR	Sends data in no-protocol according to send schedule.
Data receive in no-protocol protocol	INPUT	Receives data in no-protocol protocol.
Data send in bidirectional protocol	BIDOUT	Sends data in bidirectional protocol.
Data receive in bidirectional protocol	BIDIN	Receives data in bidirectional protocol.
Read communications status	SPBUSY	Reads communication processing status by instructions.
Read other station device	READ	Reads device data from other station CPUs connected to AJ71QC24 and MELSECNET/10.
Write other station device	SWRITE	Writes data to device of other station CPU connected to AJ71QC24 and MELSECNET/10.
Data send to other station	SEND	Sends data to other station CPU connected to AJ71QC24 and MELSECNET/10.
Data receive from other station	RECV	Receives data from other station CPU connected to AJ71QC24 and MELSECNET/10.
Transient transmission request from other station	REQ	Sends transit request to other station CPU connected to AJ71QC24 and MELSECNET/10.

POINTS

- (1) When AJ71QC24 control instructions are used, control is conducted in accordance with the following buffer memory setting values.
 - On-demand buffer memory address designation (A0H, 140H)
 - Send buffer memory first address (A2H, 142H)
 - Send buffer memory length designation (A3H, 143H)
 - Receive buffer memory first address (A6H, 146H)
 - Receive buffer memory length designation (A7H, 147H)
- (2) AJ71QC24 control instructions cannot be used for the following computer link modules.
Computer link module control instructions (see Chapter 9) cannot be used for AJ71QC24 type serial communication modules.
 - AJ71C24 computer link modules
 - AJ71C24-S3 computer link modules
 - AJ71C24-S6 computer link modules
 - AJ71C24-S8 computer link modules
 - AJ71UC24 computer link modules
- (3) See the following manual for details of the AJ71QC24 serial communication module.
 - AJ71QC24 Serial Communication Module User's Manual

- (1) About other station access with AJ71QC24 control instructions link dedicated instructions

The following is a general description of data communications using the AJ71QC24 operation mode and link dedicated instructions, which refers to accessing other stations via an AJ71QC24 by using following link dedicated instructions in the AJ71QC24 control instructions.

- READ instruction
- SWRITE instruction
- SEND instruction
- RECV instruction
- REQ instruction

- (a) AJ71QC24 operation mode*

For other station access via AJ71QC24, set the AJ71QC24 on the access route as follows.

- 1) Set operation mode to dedicated protocol (format 1 to format 5).
- 2) Set to "no interlock"

- (b) General description of data communication by link dedicated instructions

The following gives a general description of data communication with QnACPU in other stations by using link dedicated instructions.

- 1) READ/SWRITE instructions

Instructions for reading and writing data to the device memory of the QnACPU of a designated station.

- READ..... Reads data from device memory of the QnACPU at the designated station.
- SWRITE.. Writes data to the device memory of the QnACPU at the designated station.

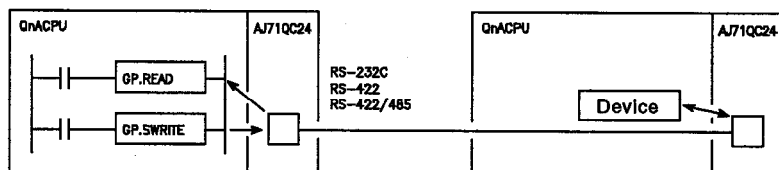

- 2) SEND/RECV instructions

Instructions for data communications between QnACPU using the OS memory of the AJ71QC24.

- SEND..... Writes designated data to designated station AJ71QC24 OS memory.
- RECV..... Reads data from host station AJ71QC24 OS memory

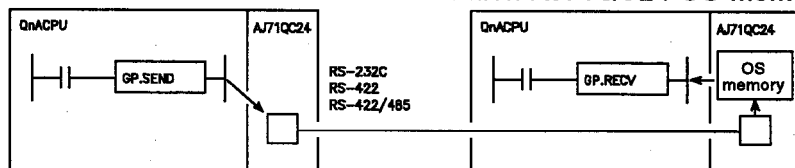

- 3) REQ instructions

Instructions for status control (remote RUN/remote STOP) and clock data read/write of the QnACPU at the designated station.

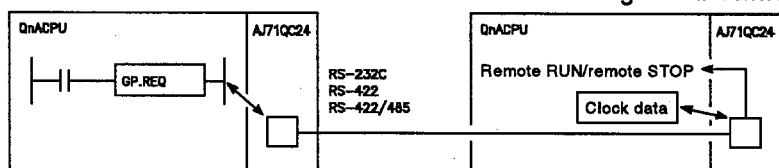

REMARK

1)* : See the AJ71QC24 Serial Communication Module User's Manual (Detailed Information) for details of the AJ71QC24 operation mode.

(2) Possible range of access with other stations

The following indicates the stations which can be accessed when accessing other stations via an AJ71QC24 with link dedicated instructions.

In the following descriptions, these accessible stations are expressed as [target station-1].

[Target station-1]

(a) The access described here is access between QnACPU's which is via AJ71QC24 only, and where the AJ71QC24's are connected by RS-232C, RS-422 interfaces, or by RS-422/485 interfaces.

(b) The connected QnACPU's (QnACPU's (1) to (9) in the following diagram) can conduct data communications by link dedicated instructions.

(c) When AJ71QC24's are connected by RS-422/485 interfaces, access between QnACPU's is possible even if external devices are connected in the circuit.

(AJ71QC24's connected by RS-232C/RS-422 interfaces) 1:1 connection possible
(Example)

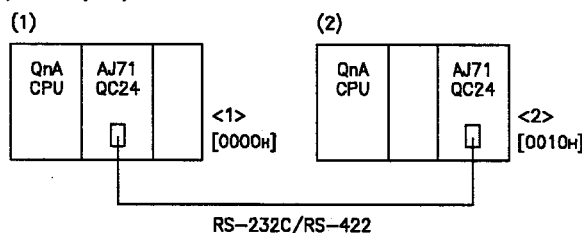

(AJ71QC24's connected by RS-422/485 interfaces) 1:1, 1:n, m:n connections possible
(Example)

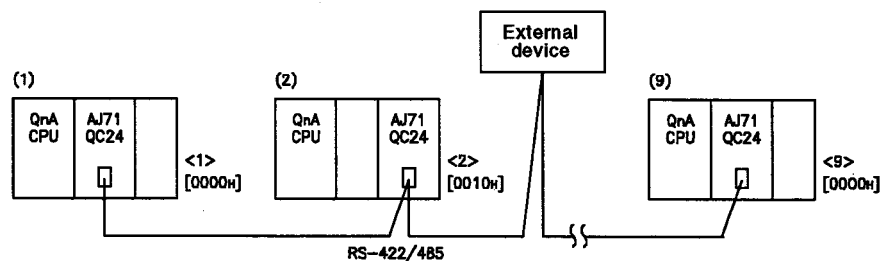

Meaning of symbol on right-hand side of AJ71QC24 installation station
< > : AJ71QC24 setting station number
[] : AJ71QC24 head I/O signal

(3) Cautions when accessing other stations

The following describes cautions when accessing other stations via an AJ71QC24 using link dedicated instructions.

(a) Method of establishing an interlock between external device and QnACPU

When the external device and QnACPU are connected in a 1:n or m:n configuration, an interlock must be established between the external device and each QnCPU so that the external device and each QnACPU do not use the RS-422/485 line at the same time. Example of how to establish an interlock.

(Example) The possibility of executing QnACPU link dedicated instructions is controlled by external devices by means of dedicated protocol global functions.^{*1}

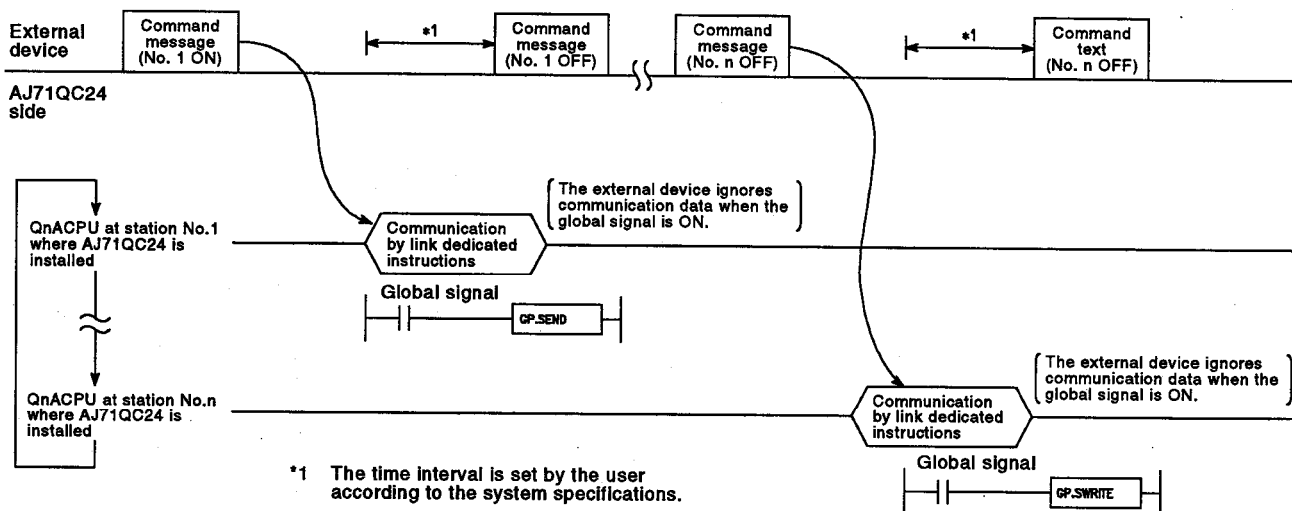

(b) Simultaneous execution of multiple instructions

The QnACPU cannot simultaneously execute multiple link dedicated instructions with the same interface (CH1 or CH2) of the relay AJ71QC24 designated.

It is essential to wait for the completion of data sending by one link dedicated instruction before executing the next link instruction. Operation is terminated by an error if instructions are simultaneously executed.

(c) Wiring connection when via RS-422/485 interface

When accessing other stations via the RS-422/485 interface of the AJ71QC24 with a system configuration of 1:n at the relay RS-422/485 interface side, connect external devices on the line, and between AJ71QC24s, by connecting the wiring in the same way as for an m:n connection.^{*2}

REMARKS

1)* : See the AJ71QC24 Serial Communication Module User's Manual for details of the dedicated protocol global functions.

2)* : See the AJ71QC24 Serial Communication User's Manual for details of the wiring method for a m:n connection.

10.1 Writing User Registration Frame to EEPROM

Set Data	Usable Devices								
	Internal Device (System, User)		File Register	MELSECNET/10 Direct JCOMM		Special Function Module UO:IG:O	Index Register Zn	Constant	Other
	Bit	Word		Bit	Word				
(S1)	—	○				—			
(S2)	—	○				—			
(D)	○	—				—			

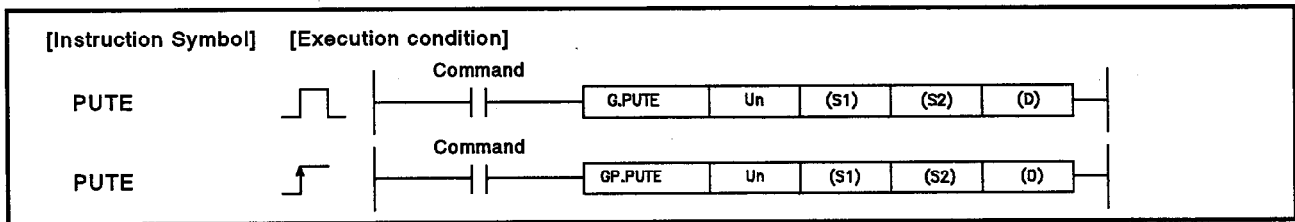

Set data

Set Data	Description	Data Type
Un	AJ71QC24 head I/O number	16-bit binary
(S1)	First device number of devices storing control data	Device name
(S2)	First device number of devices storing registered data	
(D)	Number of bit device which turns ON at execution completed	Control data

Control data

Device	Content	Set Data	Setting Range	Set by
(S1)+0	Register/delete designation	<ul style="list-style-type: none"> In a PUTE instruction, designates whether to register or delete registered data designated at S2. Register : 1 Delete : 3 	1, 3	User
(S1)+1	Register/delete result	<ul style="list-style-type: none"> Stores result of registration/deletion by PUTE instruction 0 : Normal other than 0 : Error code* 	—	System
(S1)+2	Designation frame number	<ul style="list-style-type: none"> Sets user registration frame number 	1000 to 1199	User
(S1)+3	Number of registered bytes	<ul style="list-style-type: none"> Sets number of bytes of user registration frame 	1 to 80	User

REMARKS

- 1)* : See the following manual for details of error codes for faults.
 - AJ71QC24 Serial Communication Module User's Manual.
- 2) The meanings of the entries in the "set by" column in the table above are as follows.
 - User : Data set by the user before executing PUTE instruction.
 - System : Result of PUTE instruction execution stored by QnACPU.

Function

- (1) Registration and deletion of user registration frame are conducted in the AJ71QC24 designated at Un.
- (2) Registering user registration frame
 - (a) When registering the user registration frame, makes the device designated at (S1)+1 "1".
When the device designated at (S1)+1 is "1", data from the device designated at (S2) onwards is registered in accordance with the control data designated at (S2).
 - (b) The registration data is stored in 2-byte sections from the device designated at (S2) onwards.
Therefore devices storing registration data must comprise (number of registered data)/2 points from the device designated at (S2).
For example, when registering 6 bytes of data, 3 points from the device designated at (S2) are required.

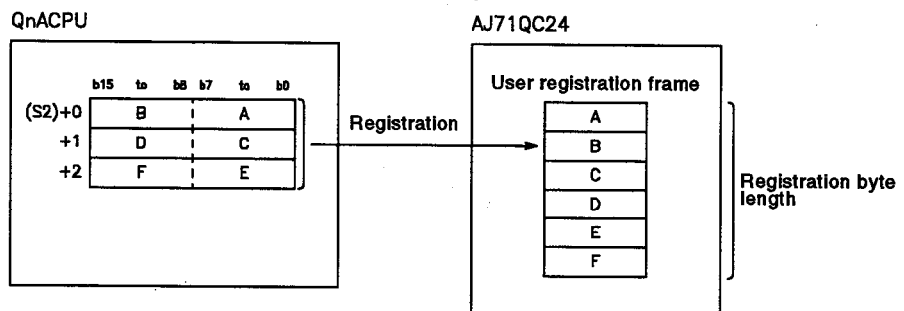

- (3) Deleting user registration frame
 - (a) When the user registration frame is deleted, the device designated at (S1)+1 is made "3".
When the device designated at (S1)+1 is 3, the frame number designated at (S1)+2 is deleted.
 - (b) The device storing the registered number of bytes designated at (S1)+3, and the registration data designated at (S2), are not used by PUTE instructions but are required for the PUTE instruction format.
Set dummy data in (S1)+3 and a dummy device in (S2).
- (4) During execution of a PUTE instruction, it is not possible to execute another PUTE instruction or a GET instruction.
If an attempt is made to execute a PUTE or GET instruction when a PUTE instruction is already being executed, the system waits until the completion of the PUTE instruction already being executed.

- (5) The normal/error completion of PUTE instructions can be confirmed by means of the completion device ((D)) or status indication device ((D)+1) at completion.
 - (a) Completion device
 - : Turns ON at END processing of the scan completing PUTE instruction, and turns OFF at the next END processing.
 - (b) Completion status indication device
 - : Turns ON/OFF depending on the status when PUTE instruction is completed.
 - Normal completion : Stays OFF, no change.
 - Error completion : Turns ON at END processing of scan completing PUTE instruction, turns OFF at next END processing.

[Operation at PUTE instruction execution]

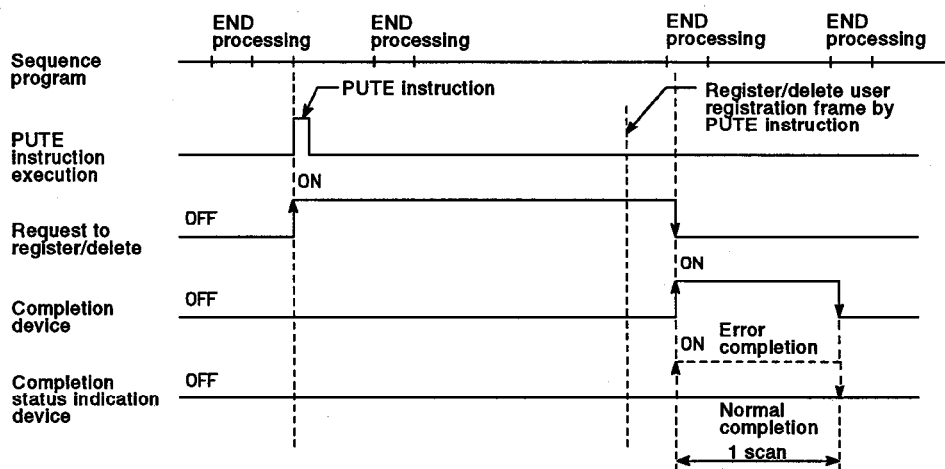

Operation Errors

- (1) In the following cases, an operation error occurs, the error flag (SM0) turns ON, and the error code is stored in SD0.
 - When the control data contents are outside the setting range. (Error code: 4100)
 - When the module attempting access is not a special function module. (Error code: 2110)
 - When AJ71QC24 control instructions cannot be used with the designated module. (Error code: 2112)
 - When the designated instruction name is illegal. (Error code: 4300)
 - When the number of AJ71QC24 control instruction devices is illegal. (Error code: 4301)
 - When a non-designatable device is designated. (Error code: 4302)

Program Example

- (1) A program which, when X30 turns ON, registers 8 bytes of data stored in D4-D7 to user registration frame number 1000 is shown below.
(Control data is set in D0 to D3).

[Ladder mode]

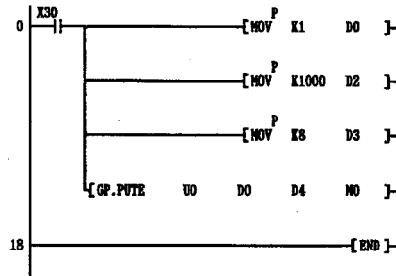

[List mode]

Step	Instruction	Device
0	LD	X30
1	MOV P	K1 D0
4	MOV P	K1000 D2
7	MOV P	K8 D3
10	GP.PUTE	U0 D0 D4 M0
18	END	

- (2) A program which, when X30 turns ON, deletes the user registration frame number 1000 is shown below.
(Control data is set in D0 to D3).

[Ladder mode]

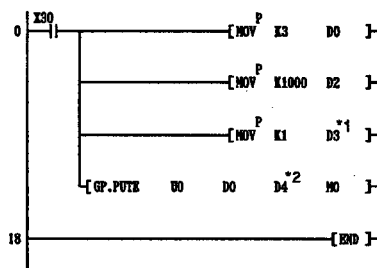

[List mode]

Step	Instruction	Device
0	LD	X30
1	MOV P	K3 D0
4	MOV P	K1000 D2
7	MOV P	K1 D3
10	GP.PUTE	U0 D0 D4 M0
18	END	

REMARKS

- 1) *1 : Store dummy data in D3 in the range of 1 to 80.
2) *2 : D4 is the dummy device.

10.2 Reading User Registration Frame from EEPROM

Set Data	Usable Devices								
	Internal Device (System, User)		File Register	MELSECNET/10 Direct J-BUS		Special Function Module U-BUS	Index Register Zn	Constant	Other
	Bit	Word		Bit	Word				
(S1)	—	○							
(S2)	—	○							
(D)	○	—							

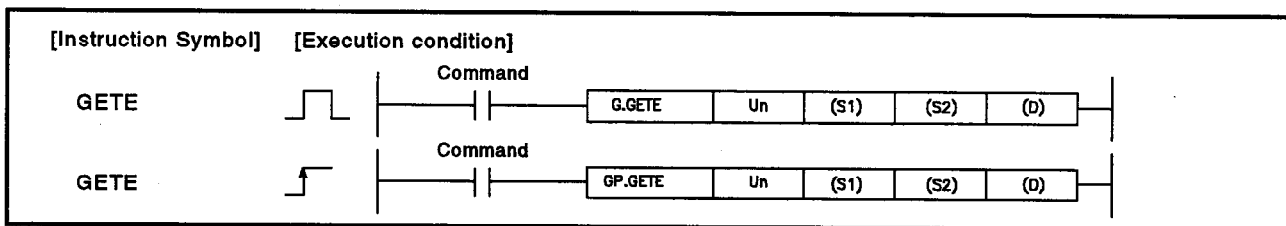

Set data

Set Data	Description	Data Type
Un	AJ71QC24 head I/O number	16-bit binary
(S1)	First device number of devices storing control data	Device name
(S2)	First device number of devices storing the read registration data.	
(D)	Number of the bit device turning ON at execution completion	Bit

Control data

Device	Content	Set Data	Setting Range	Set by
(S1)+0	Dummy	• Not used	0	—
(S1)+1	Read result	• Stores GETE instruction read result 0 : Normal other than 0 : Error Code*	—	System
(S1)+2	Designation frame number	• Sets user registration frame number	1000 to 1199	User
(S1)+3	Number of registered bytes	• Sets number of bytes of user registration frame	1 to 80	User

REMARKS

- 1)* : See the following manual for details of error codes for faults.
AJ71QC24 Serial Communication Module User's Manual.
- 2) The meanings of the entries in the "set by" column in the table above are as follows.
 - User : Data set by the user before executing GET instruction.
 - System : Result of GET instruction execution stored by QnACPU.

Function

- (1) Reads designated user registration frame data at the AJ71QC24 designated by Un.

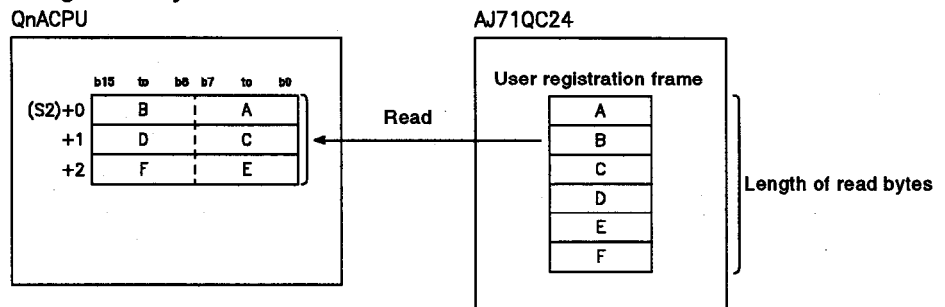

- (2) During GETE instruction execution, other GETE instructions or PUTE instructions cannot be executed.
If an attempt is made to execute a GETE or PUTE instruction during GETE instruction execution, the system waits until completion of the execution of the instruction already being executed.
- (3) GETE instruction normal/error completion can be confirmed by completion device (D) or completion status indication device ((D)+1).
 - (a) Completion device
 - : Turn ON at the END processing of the scan completing GETE instruction, and turns OFF at the next END processing.
 - (b) Completion status indication device
 - : Turn ON/OFF depending on the status at the time of completion of GETE instruction.
 - Normal completion : Stays OFF, no change.
 - Error completion : Turns ON at END processing of the scan completing GETE instruction, and turns OFF at the next END processing.

[Operation at GETE instruction execution]

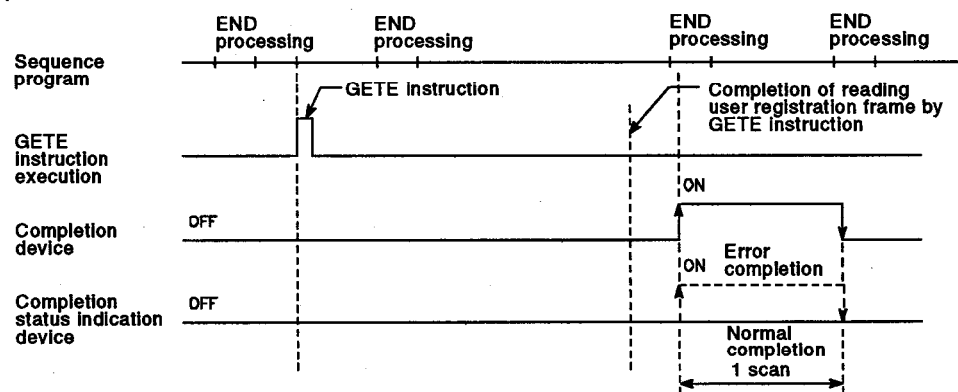

Operation Errors

- (1) In the following cases, an operation error occurs, the error flag (SM0) turns ON, and the error code is stored in SD0.
 - When the control data contents are outside the setting range. (Error code: 4100)
 - When the module attempting access is not a special function module. (Error code: 2110)
 - When AJ71QC24 control instructions cannot be used with the designated module. (Error code: 2112)
 - When the designated instruction name is illegal. (Error code: 4300)
 - When the number of AJ71QC24 control instruction devices is illegal. (Error code: 4301)
 - When a non-designatable device is designated. (Error code: 4302)

Program Example

- (1) A program which, when X30 turns ON, reads 10 bytes of data from user registration frame number 1000 and stores it from D10 onwards is shown here.
(Control data is set in D0 to D3).

[Ladder mode]

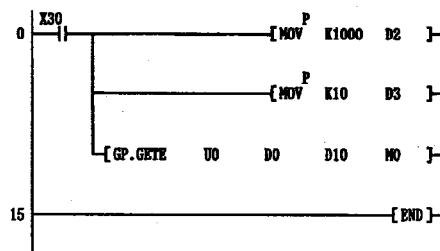

[List mode]

Step	Instruction	Device
0	LD	X30
1	MOV P	K1000 D2
4	MOV P	K10 D3
7	GP.GETE	U0 D0 D10 MO
15	END	

10.3 Data Send by Dedicated Protocol On-Demand Function

Set Data	Usable Devices								
	Internal Device (System, User)		File Register	MELSECNET/10 Direct JEMEC		Special Function Module UEMGEC	Index Register Zn	Constant	Other
	Bit	Word		Bit	Word				
(S1)	—	○							
(S2)	—	○							
(D)	○	—							

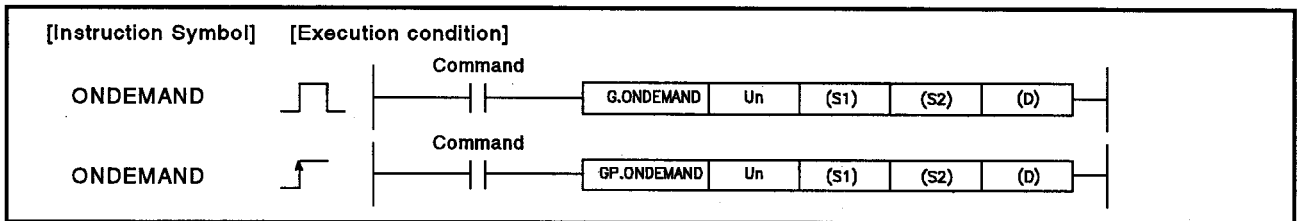

Set data

Set Data	Description	Data Type
Un	AJ71QC24 head I/O number	16-bit binary
(S1)	First device number of devices storing control data	Device name
(S2)	First device number of devices storing send data	
(D)	Number of the bit device turning ON at execution completion	Bit

Control data

Device	Content	Set Data	Setting Range	Set by
(S1)+0	Send channel	<ul style="list-style-type: none"> Sets the send channel 1 : Channel 1 2 : Channel 2 	1, 2	User
(S1)+1	Send result	<ul style="list-style-type: none"> Stores result of reading by ON DEMAND instruction 0 : Normal other than 0 : Error code *1 	—	System
(S1)+2	Number of send data	<ul style="list-style-type: none"> Sets number of data to send *2 	1 to	User

REMARKS

- 1) *1 : See the following manual for details of error codes for faults.
AJ71QC24 Serial Communication Module User's Manual.
- 2) *2 : When bytes designated sets number of bytes, when words designated, sets number of words in AJ71QC24.
- 3) The meanings of the entries in the "set by" column in the table above are as follows.
 - User : Data set by the user before executing ONDEMAND instruction.
 - System : Result of ONDEMAND instruction execution stored by QnACPU.

Function

- (1) Sends data stored from the device designated at (S2) onwards by the on-demand function in dedicated protocol, to the AJ71QC24 designated at Un, according to the control data from the device designated at (S1) onwards.

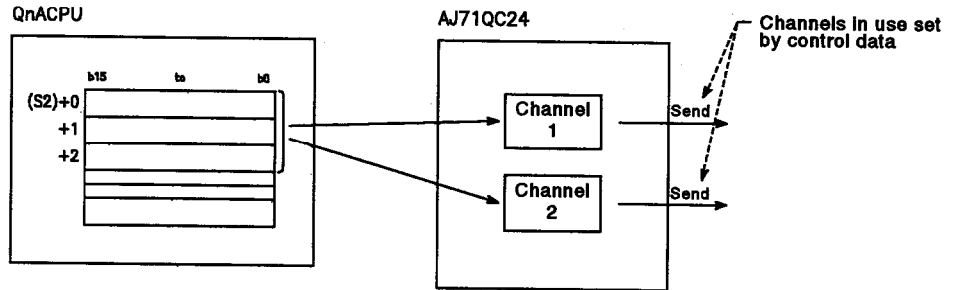

- (2) The following instructions cannot be simultaneously executed in channels executing ONDEMAND instructions.

- Other ONDEMAND instructions
- OUTPUT instructions
- PRR instructions
- BIDOUT instructions

If an attempt is made to execute any of the above instructions while an ONDEMAND instruction is being executed, the system waits until the ONDEMAND instruction already being executed is completed.

- (3) Normal/error completion of ONDEMAND instructions can be confirmed by means of the completion device (D) or completion status indication device ((D)+1).

(a) Completion device

: Turns ON at END processing of the scan completing ONDEMAND instruction, and turns Off at next END processing.

(b) Completion status indication device

: Turn ON/OFF depending on status at time of completion of ONDEMAND instructions.

- Normal completion : Stays OFF, no change.
- Error completion : Turns ON at END processing of scan completing ONDEMAND instruction, and turns OFF at next END processing.

[Operation at ONDEMAND instruction execution]

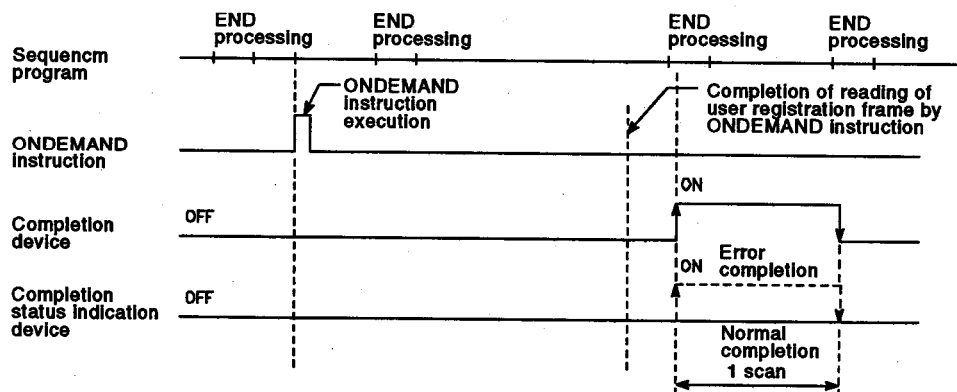

Operation Errors

- (1) In the following cases, an operation error occurs, the error flag (SM0) turns ON, and the error code is stored in SD0.
 - When the control data contents are outside the setting range. (Error code: 4100)
 - When the module attempting access is not a special function module. (Error code: 2110)
 - When AJ71QC24 control instruction cannot be used with the designated module. (Error code: 2112)
 - When the designated instruction name is illegal. (Error code: 4300)
 - When the number of AJ71QC24 control instruction devices is illegal. (Error code: 4301)
 - When a non-designatable device is designated. (Error code: 4302)

Program Example

- (1) A program which, when X30 turns ON, sends data (byte designation) stored in D10-D14 from channel 2 is shown here. (Control data is set in D0 to D2).

[Ladder mode]

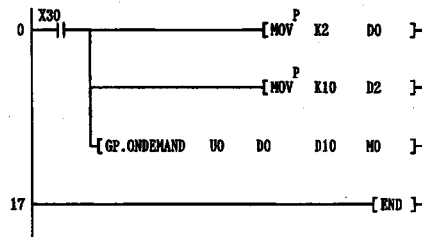

[List mode]

Step	Instruction	Device
0	LD	X30
1	MOVP	K2 D0
4	MOVP	K10 D2
7	GP.ONDEMAND	U0 D0 D10 MO
17	END	

10.4 Sending Designated Number of Data in No-Protocol Mode

Set Data	Usable Devices								
	Internal Device (System, User)		File Register	MELSECNET/10 Direct J-BUS		Special Function Module USERG	Index Register Zn	Constant	Other
	Bit	Word		Bit	Word				
(S1)	—	○				—			
(S2)	—	○				—			
(D)	○	—				—			

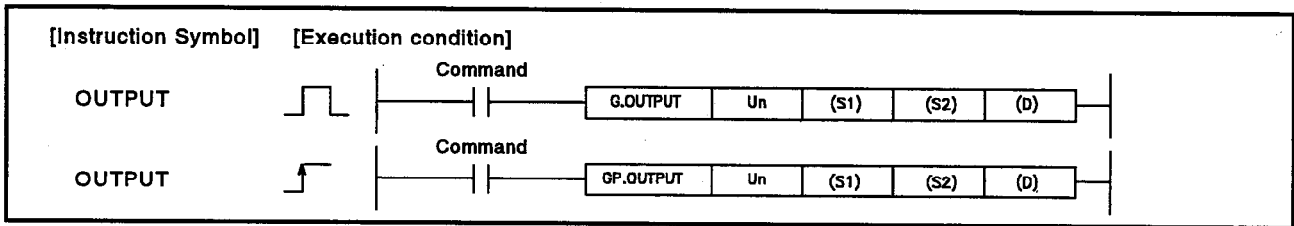

Set data

Set Data	Description	Data Type
Un	AJ71QC24 head I/O number	16-bit binary
(S1)	First device number of devices storing control data	Device name
(S2)	First device number of devices storing send data	
(D)	Number of the bit device turning ON at execution completion	Bit

Control data

Device	Content	Set Data	Setting Range	Set by
(S1)+0	Send channel	<ul style="list-style-type: none"> Sets the send channel 1 : Channel 1 2 : Channel 2 	1, 2	User
(S1)+1	Send result	<ul style="list-style-type: none"> Stores result of sending by OUTPUT instruction 0 : Normal other than 0 : Error code *1 	—	System
(S1)+2	Number of send data	<ul style="list-style-type: none"> Sets number of data to send *2 	1 to	User

REMARKS

- 1) *1 : See the following manual for details of error codes for faults.
AJ71QC24 Serial Communication Module User's Manual.
- 2) *2 : When bytes designated sets number of bytes, when words designated, sets number of words in AJ71QC24.
- 3) The meanings of the entries in the "set by" column in the table above are as follows.
 - User : Data set by the user before executing OUTPUT instruction.
 - System : Result of OUTPUT instruction execution stored by QnACPU.

Function

- (1) Sends data stored from the device designated at (S2) onwards according to control data from the device designated in (S1) onwards to AJ71QC24 designated at Un in no-protocol mode.

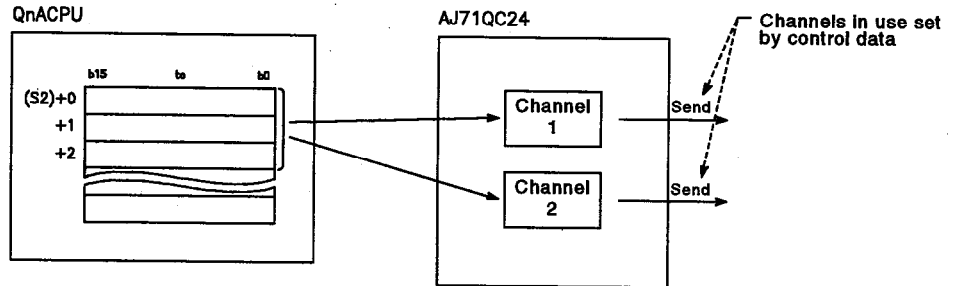

- (2) The following instruction cannot be executed simultaneously in channels executing OUTPUT instruction.

- Other OUTPUT instructions
- ONDEMAND instructions
- PRR instructions
- BIDOUT instructions

If an attempt is made to execute the above instructions while an OUTPUT instruction is being executed, the system waits until the OUTPUT instruction being executed is completed.

- (3) Normal/error completion of OUTPUT instructions can be confirmed by means of the completion device (D) or completion status indication device ((D)+1).

(a) Completion device

: Turns ON at END processing of scan completing OUTPUT, and turns OFF at next END processing.

(b) Completion status indication device

: Turns ON/OFF depending on status at time of completion of OUTPUT instruction.

- Normal completion : Stays OFF, no change.
- Error completion : Turn ON at END processing of scan completing OUTPUT instruction, and turns OFF at next END processing.

[Operation at execution of OUTPUT instruction]

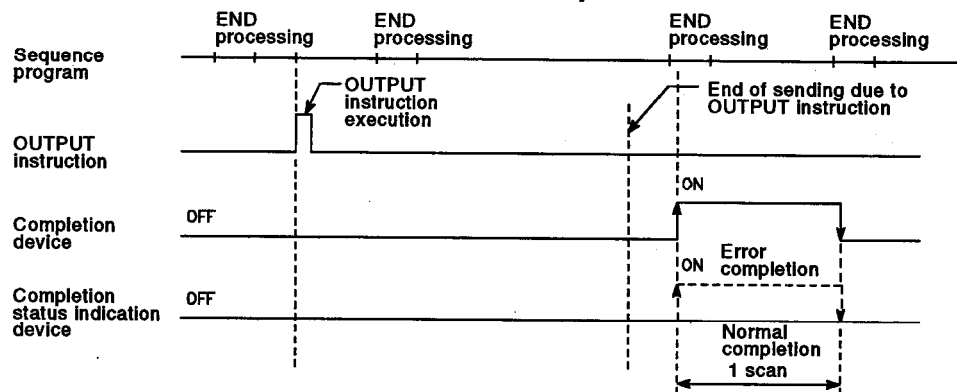

Operation Errors

- (1) In the following cases, an operation error occurs, the error flag (SM0) turns ON, and the error code is stored in SD0.
- When the control data contents are outside the setting range. (Error code: 4100)
 - When the module attempting access is not a special function module. (Error code: 2110)
 - When AJ71QC24 control instructions cannot be used with the designated module. (Error code: 2112)
 - When the designated instruction name is illegal. (Error code: 4300)
 - When the number of AJ71QC24 control instruction devices is illegal. (Error code: 4301)
 - When a non-designatable device is designated. (Error code: 4302)

Program Example

- (1) A program which, when X30 turns ON, sends data (byte designation) stored in D10-D14 from channel 1 is shown here.
(Control data is set in D0 to D2).

[Ladder mode]

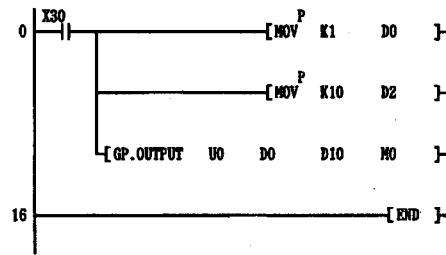

[List mode]

Step	Instruction	Device
0	LD	X30
1	MOV P	K1 D0
4	MOV P	K10 D2
7	GP.OUTPUT	UO D0 D10 M0
16	END	

10.5 Data Send Using Send Schedule Table in No-Protocol Mode

Set Data	Usable Devices								
	Internal Device (System, User)		File Register	MELSECNET/10 Direct I/O		Special Function Module I/O	Index Register Zn	Constant	Other
	Bit	Word		Bit	Word				
(S)	—	0							
(D)	0	—							

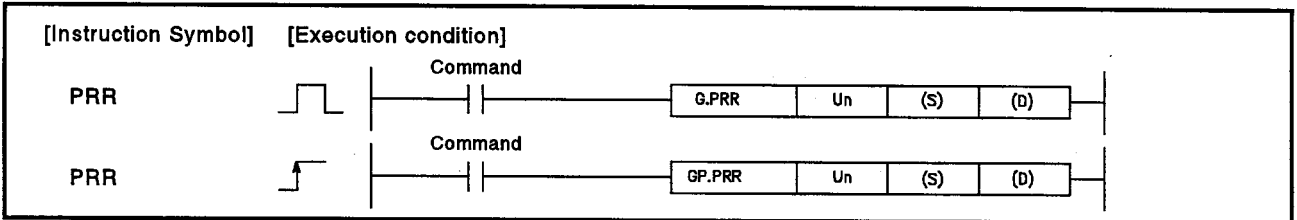

Set data

Set Data	Description	Data Type
Un	AJ71QC24 head I/O number	16-bit binary
(S)	First device number of devices storing control data	Device name
(D)	Number of the bit device turning ON at execution completion	Bit

Control data

Device	Content	Set Data	Setting Range	Set by
(S)+0	Send channel	<ul style="list-style-type: none"> Sets the send channel 1 : Channel 1 2 : Channel 2 	1, 2	User
(S)+1	Send result	<ul style="list-style-type: none"> Stores result of send by PRR instruction 0 : Normal other than 0 : Error code *1 	—	System
(S)+2	CR/LF addition designation	<ul style="list-style-type: none"> Sets whether or not to add CR/LF to send data 0 : Not add CR/LF 1 : Add CR/LF 	0, 1	User
(S)+3	Send pointer	<ul style="list-style-type: none"> Sets send schedule pointer 	1 to 100	User
(S)+4	No. of schedules	<ul style="list-style-type: none"> Number of schedules used for send 	1 to 100	User

REMARKS

- 1) *1 : See the following manual for details of error codes for faults.
AJ71QC24 Serial Communication Module User's Manual.
- 2)* : The meanings of the entries in the "set by" column in the table above are as follows.
 - User : Data set by the user before executing PRR instruction.
 - System : Result of PRR instruction execution stored by QnACPU.

Function

- (1) Sets the control data stored from the device designated at (S) onwards, and sends it in accordance with the AJ71QC24 schedule table to the AJ71QC24 designated at Un in the no-protocol mode.
- (2) The following instructions cannot be simultaneously executed in channels executing PRR instructions.
 - OUTPUT instructions
 - ONDEMAND instructions
 - Other PRR instructions
 - BIDOUT instructions

If an attempt is made to execute any of the above instructions while a PRR instruction is being executed, the system waits until the PRR instruction being executed is completed.
- (3) Normal/error completion of PRR instructions can be confirmed by means of the completion device (D) or completion status indication device ((D)+1).
 - (a) Completion device
 - : Turns ON at END processing of scan completing PRR instruction, and turns OFF at next END processing.
 - (b) Completion status indication device
 - : Turns ON/OFF depending on status at completion of PRR instruction.
 - Normal completion : Stays OFF, no change.
 - Error completion : Turns ON at END processing of scan completing PRR instruction, and turns OFF at next END processing.

[Operation at execution of PRR instruction]

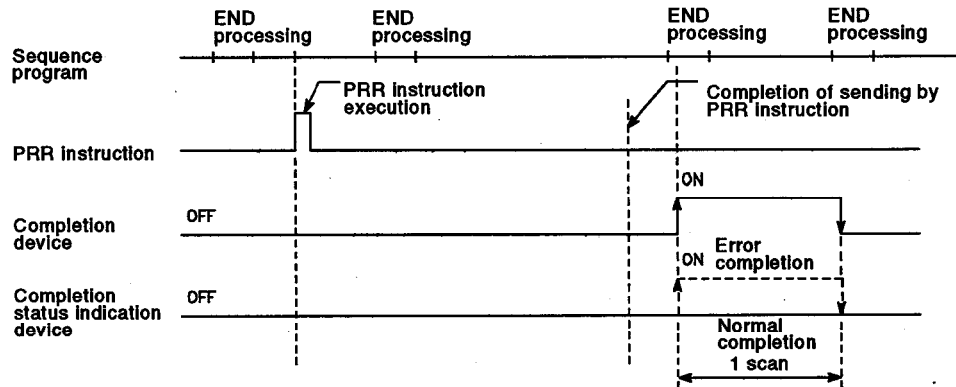

Operation Errors

- (1) In the following cases an operation error occurs, the error flag (SM0) turns ON, and the error code is stored in SD0.
 - When the control data contents are outside the setting range. (Error code: 4100)
 - When the module attempting access is not a special function module. (Error code: 2110)
 - When AJ71QC24 control instructions cannot be used with the designated module. (Error code: 2112)
 - When the designated instruction name is illegal. (Error code: 4300)
 - When the number of AJ71QC24 control instruction devices is illegal. (Error code: 4301)
 - When a non-designatable device is designated. (Error code: 4302)

Program Example

- (1) A program which, when X30 turns ON, sends send schedule points 10-15 from channel 2 is shown here.
 At this time the program adds CR/LF.
 (Control data is stored in D0 to D4)

[Ladder mode]

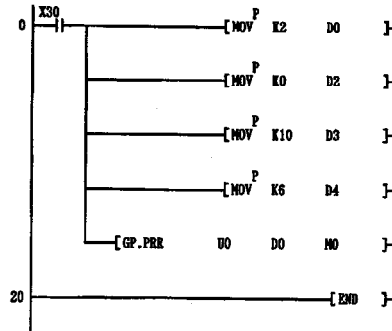

[List mode]

Step	Instruction	Device
0	LD	X30
1	MOV	K2 D0
4	MOV	K0 D2
7	MOV	K10 D3
10	MOV	K6 D4
13	GP.PRR	U0 D0
20	END	MO

10.6 Data Receive in No-Protocol Protocol

Set Data	Usable Devices								
	Internal Device (System, User)		File Register	MELSECNET/10 Direct J[...]		Special Function Module U[...]	Index Register Zn	Constant	Other
	Bit	Word		Bit	Word				
(S1)	—	○							
(S2)	—	○							
(D)	○	—							

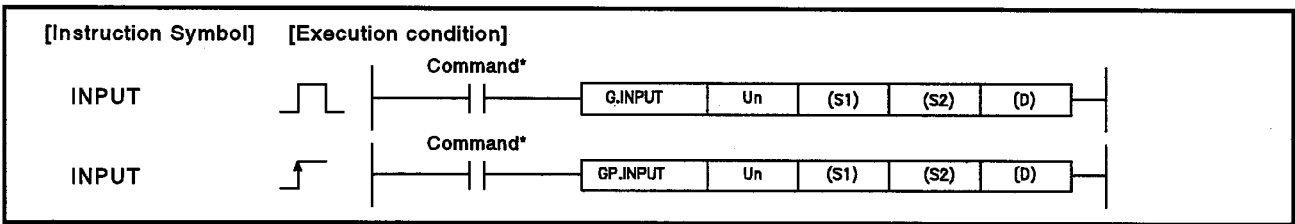

Set data

Set Data	Description	Data Type
Un	AJ71QC24 head I/O number	16-bit binary
(S1)	First device number of devices storing control data	Device name
(S2)	First device number of devices storing received data	
(D)	Number of the bit device turning ON at execution completion	Bit

Control data

Device	Content	Set Data	Setting Range	Set by
(S)+0	Receive channel	<ul style="list-style-type: none"> Sets the send channel 1 : Channel 1 2 : Channel 2 	1, 2	User
(S)+1	Receive result	<ul style="list-style-type: none"> Stores the result of receive by INPUT instruction 0 : Normal other than 0 : Error code *1 	—	System
(S)+2	Number of received data	<ul style="list-style-type: none"> Sets the number of receive data *2 	1 to	User
(S)+3	Permissible number of received data	<ul style="list-style-type: none"> Sets the permissible number of words for (S2). 	1 to	User

POINTS

- (1) The G(P).INPUT command cannot be made into a pulse.
- (2) Execute G(P).INPUT when I/O signal read request is ON.

REMARKS

- 1) *1 : See the following manual for details of error codes for faults.
AJ71QC24 Serial Communication Module User's Manual.
- 2) *2 : When bytes designated sets number of bytes, when words designated, sets number of words in AJ71QC24.
- 3) The meanings of the entries in the "set by" column in the table above are as follows.
 - User : Data set by the user before executing INPUT instruction.
 - System : Result of INPUT instruction execution stored by QnACPU.

Function

- (1) Stores data received in no-protocol mode AJ71QC24 designated at Un according to the control data of the devices designated at (S1) onwards, to devices starting at the one designated at (S2).
- (2) The following instructions cannot be executed in channels executing INPUT instructions.
 - Other INPUT instructions
 - BIDOUT instructions

If an attempt is made to execute either of the above instructions while an INPUT instruction is being executed, the system waits until the PRR instruction being executed is completed.
- (3) Normal/error completion of INPUT instructions can be confirmed by means of the completion device (D) or completion status indication device ((D)+1).
 - (a) Completion device
 - : Turns ON at END processing of scan completing INPUT instruction, and turns OFF at next END processing.
 - (b) Completion status indication device
 - : Turns ON/OFF depending on status at completion of INPUT instruction.
 - Normal completion : Stays OFF, no change.
 - Error completion : Turns ON at END processing of scan completing INPUT instruction, and turns OFF at next END processing.

[Operation at execution of INPUT instruction]

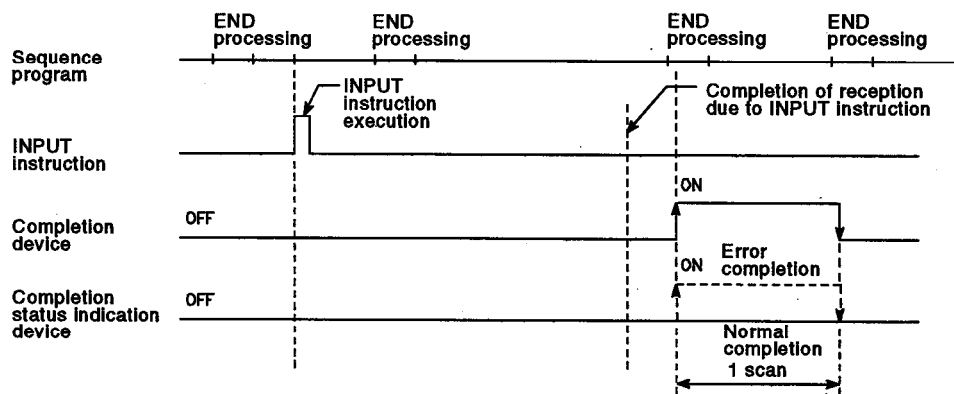

Operation Errors

- (1) In the following cases an operation error occurs, the error flag (SM0) turns ON, and the error code is stored in SD0.
- When the control data contents are outside the setting range. (Error code: 4100)
 - When the module attempting access is not a special function module. (Error code: 2110)
 - When AJ71QC24 control instructions cannot be used with the designated module. (Error code: 2112)
 - When the designated instruction name is illegal. (Error code: 4300)
 - When the number of AJ71QC24 control instruction devices is illegal. (Error code: 4301)
 - When a non-designatable device is designated. (Error code: 4302)

Program Example

- (1) A program which, when X0 turns ON, stores data received in channel 2 to D10 and onwards is shown here.
 The number of received data and permissible number of received data is set to 20.
 (Control data is stored in D0 to D3)

[Ladder mode]

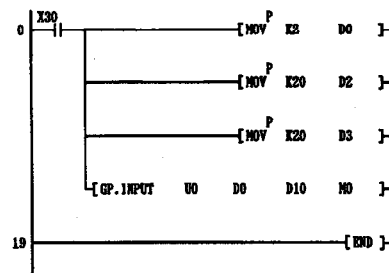

[List mode]

Step	Instruction	Device
0	LD	X30
1	MOV P	K2
		D0
4	MOV P	K20
		D2
7	MOV P	K20
		D3
10	GP.INPUT	U0
		D0
		D10
		M0
19	END	

10.7 Data Send of Designated Number of Data in Bidirectional Protocol

Set Data	Usable Devices								
	Internal Device (System, User)		File Register	MELSECNET/10 Direct J-box		Special Function Module Usage	Index Register Zn	Constant	Other
	Bit	Word		Bit	Word				
(S1)	—	○							
(S2)	—	○							
(D)	○	—							

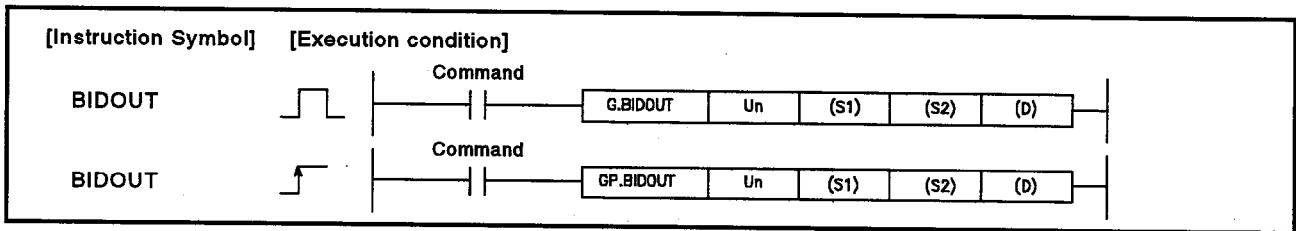

Set data

Set Data	Description	Data Type
Un	AJ71QC24 head I/O number	16-bit binary
(S1)	First device number of devices storing control data	Device name
(S2)	First device number of devices storing send data	
(D)	Number of the bit device turning ON at execution completion	Bit

Control data

Device	Content	Set Data	Setting Range	Set by
(S)+0	Send channel	<ul style="list-style-type: none"> Sets the send channel 1 : Channel 1 2 : Channel 2 	1, 2	User
(S)+1	Send result	<ul style="list-style-type: none"> Stores result of send by BIDOUT instruction 0 : Normal other than 0 : Error code *1 	—	System
(S)+2	Number of send data	<ul style="list-style-type: none"> Sets number of data to send *2 	1 to	User

REMARKS

- *1 : See the following manual for details of error codes for faults.
AJ71QC24 Serial Communication Module User's Manual.
- *2 : When bytes designated sets number of bytes, when words designated, sets number of words in AJ71QC24.
- The meanings of the entries in the "set by" column in the table above are as follows.
 - User : Data set by the user before executing BIDOUT instruction.
 - System : Result of BIDOUT instruction execution stored by QnACPU.

Function

- (1) Sends data stored from the device designated at (S2) onwards in bidirectional protocol of AJ71QC24 designated at Un, in accordance with control data of the devices starting from the one designated at (S1).
- (2) The following instructions cannot be simultaneously executed in channels executing BIDOUT instructions.
 - OUTPUT instructions
 - ONDEMAND instructions
 - PRR instructions
 - Other BIDOUT instructions

If an attempt is made to execute any of the instructions above while a BIDOUT instruction is being executed, the system waits until the BIDOUT instruction being executed is completed.
- (3) Normal/error completion of BIDOUT instructions can be confirmed by means of the completion device (D) or completion status indication device ((D)+1).
 - (a) Completion device
 - : Turns ON at END processing of scan completing the BIDOUT instruction, and turns OFF at next END processing.
 - (b) Completion status indication device
 - : Turns ON/OFF depending on status at completion of BIDOUT instruction.
 - Normal completion : Stays OFF, no change.
 - Error completion : Turns ON at END processing of scan completing BIDOUT instruction, and turns OFF at next END processing.

[Operation at execution of BIDOUT instruction]

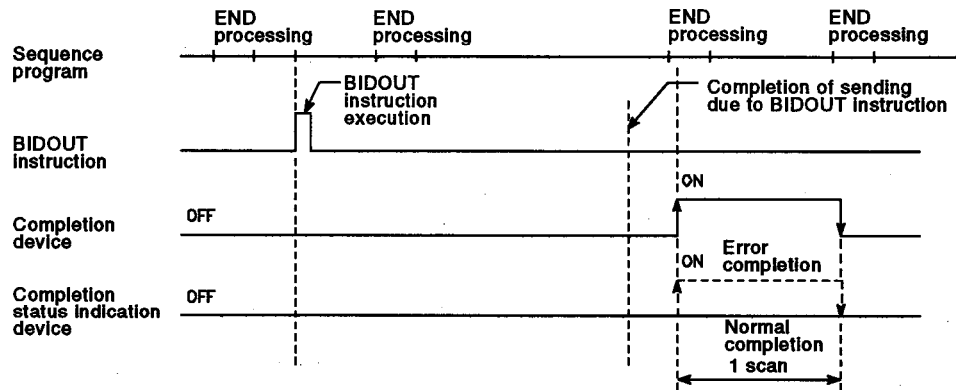

Operation Errors

- (1) In the following cases an operation error occurs, the error flag (SM0) turns ON, and the error code is stored in SD0.
 - When the control data contents are outside the setting range. (Error code: 4100)
 - When the module attempting access is not a special function module. (Error code: 2110)
 - When AJ71QC24 control instructions cannot be used with the designated module. (Error code: 2112)
 - When the designated instruction name is illegal. (Error code: 4300)
 - When the number of AJ71QC24 control instruction devices is illegal. (Error code: 4301)
 - When a non-designatable device is designated. (Error code: 4302)

Program Example

- (1) A program which, when X30 turns ON, sends data (byte designation) stored in D10-D14 from channel 1 is shown here.
 (Control data is stored in D0 to D2)

[Ladder mode]

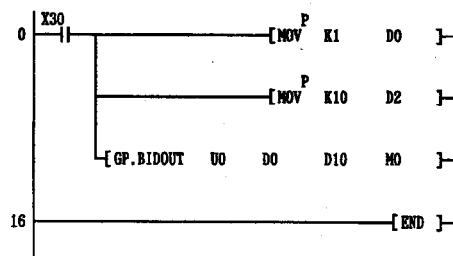

[List mode]

Step	Instruction	Device
0	LD	X30
1	MOVP	K1 D0
4	MOVP	K10 D2
7	GP.BIDOUT	U0 D0 D10 MO
16	END	

10.8 Data Receive in Bidirectional Protocol

Set data	Usable Devices								
	Internal Device (System, User)		File Register	MELSECNET/10 Direct J-BUS		Special Function Module U-BUS/G-BUS	Index Register Zn	Constant	Other
	Bit	Word		Bit	Word				
(S1)	—	○				—			
(S2)	—	○				—			
(D)	○	—				—			

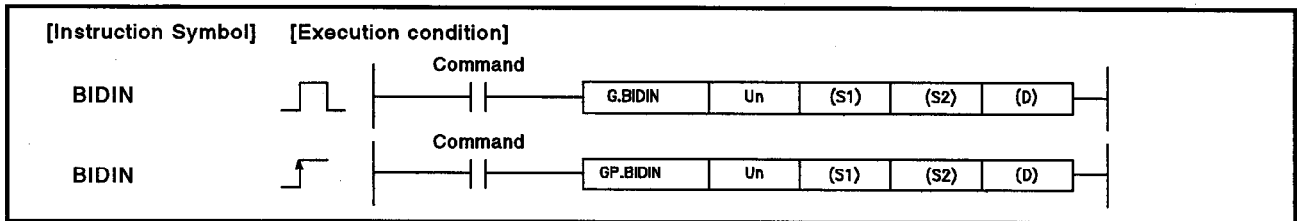

Set data

Set Data	Description	Data Type
Un	AJ71QC24 head I/O number	16-bit binary
(S1)	First device number of devices storing control data	Device name
(S2)	First device number of devices storing received data	
(D)	Number of the bit device turning ON at execution completion	Bit

Control data

Device	Content	Set Data	Setting Range	Set by
(S)+0	Receive channel	<ul style="list-style-type: none"> Sets the receive channel 1 : Channel 1 2 : Channel 2 	1, 2	User
(S)+1	Receive result	<ul style="list-style-type: none"> Stores result of receive by BIDIN instruction 0 : Normal other than 0 : Error code *1 	—	System
(S)+2	Number of received data	<ul style="list-style-type: none"> Sets the number of receive data *2 	1 to	User
(S)+3	Permissible number of received data	<ul style="list-style-type: none"> Sets the permissible number of words for (S2). 	1 to	User

POINTS
(1) G(P).BIDIN commands cannot be changed into pulse.
(2) Execute G(P).BIDIN when I/O signal read request is ON.

REMARKS

- 1) *1 : See the following manual for details of error codes for faults.
AJ71QC24 Serial Communication Module User's Manual.
- 2) *2 : When bytes designated sets number of bytes, when words designated, sets number of words in AJ71QC24.
- 3) The meanings of the entries in the "set by" column in the table above are as follows.
 - User : Data set by the user before executing BIDIN instruction.
 - System : Result of BIDIN instruction execution stored by QnACPU.

Function

- (1) Stores data received in bidirectional protocol of AJ71QC24 designated at Un, according to control data from the device designated at (S1) onwards, to the devices starting from the one designated at (S2).
- (2) The following instructions cannot be simultaneously executed in channels executing BIDIN instructions
 - Other BIDIN instructions
 - INPUT instructions

If an attempt is made to execute any of the instructions above while a BIDIN instruction is being executed, the system waits until the BIDIN instruction being executed is completed.
- (3) Normal/error completion of BIDIN instructions can be confirmed by means of the completion device (D) or completion status indication device ((D)+1).
 - (a) Completion device
 - : Turns ON at END processing of scan completing BIDOUT instruction, and turns OFF at next END processing.
 - (b) Completion status indication device
 - : Turns ON/OFF depending on status at completion of BIDIN instruction.
 - Normal completion : Stays OFF, no change.
 - Error completion : Turns ON at END processing of scan completing BIDIN instruction, and turns OFF at next END processing.

[Operation at execution of BIDIN instruction]

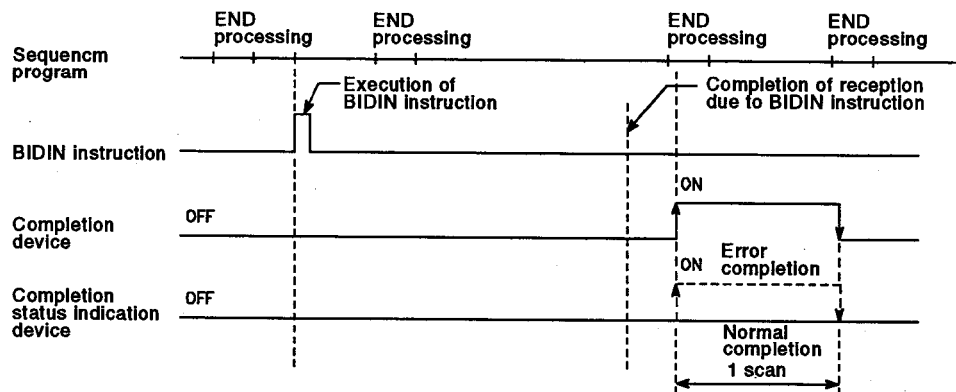

Operation Errors

- (1) In the following cases an operation error occurs, the error flag (SM0) turns ON, and the error code is stored in SD0.
 - When the control data contents are outside the setting range. (Error code: 4100)
 - When the module attempting access is not a special function module. (Error code: 2110)
 - When AJ71QC24 control instructions cannot be used with the designated module. (Error code: 2112)
 - When the designated instruction name is illegal. (Error code: 4300)
 - When the number of AJ71QC24 control instruction devices is illegal. (Error code: 4301)
 - When a non-designatable device is designated. (Error code: 4302)

Program Example

- (1) A program which, when X30 turns ON, stores data received in channel 2 to D10 and onwards is shown here.
 The number of received data and permissible number of received data is set to 20.
 (Control data is stored in D0 to D3)

[Ladder mode]

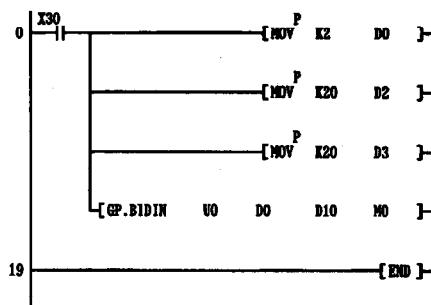

[List mode]

Steps	Instruction	Device
0	LD	X30
1	MOVP	K1 D0
4	MOVP	K10 D2
7	GP.BIDOUT	U0 D0 D10 M0
16	END	

10.9 Read Communications Status

Set data	Usable Devices								
	Internal Device (System, User)		File Register	MELSECNET/10 Direct JUNCTION		Special Function Module UCC/AGC	Index Register Zn	Constant	Other
	Bit	Word		Bit	Word				
(D)	0		—						

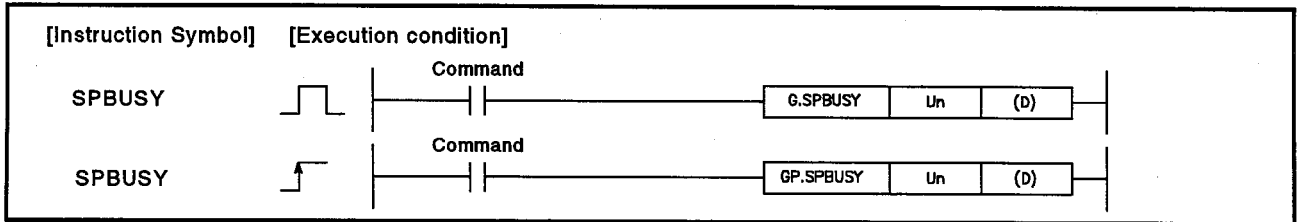

Set data

Set Data	Description	Data Type
Un	AJ71QC24 head I/O number	16-bit binary
(D)	First device number of devices storing the read communication status	Device name

Function

- Reads the execution status of AJ71QC24 control instructions for AJ71QC24 designated at head I/O number, and stores execution status to the device designated at (D) and onwards.
- The execution statuses are stored in (D) as follows: each bit is set to "1" when the processing for the corresponding instruction starts, and "0" on completion of processing for the corresponding instruction. The completion of processing of instructions is defined as when the instruction completion flag turns OFF.

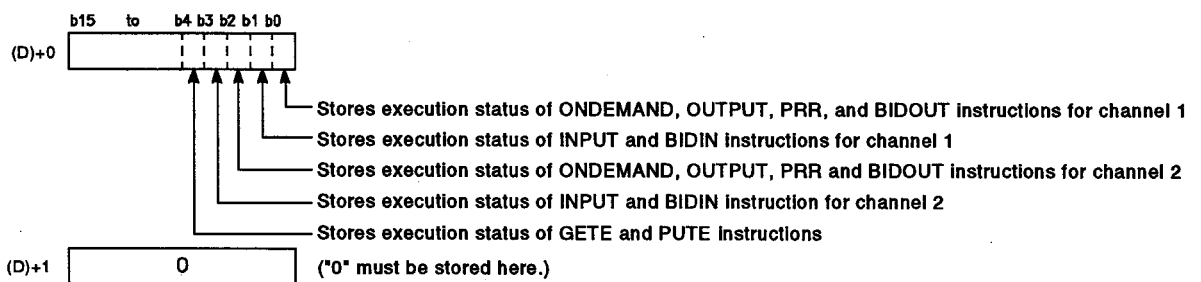

- If the execution condition is "executed during ON", the SPBUSY instruction is executed every scan while the read command is ON; if it is "executed once at ON", it is only executed in one scan when the read command goes from OFF to ON.

Operation Errors

- (1) In the following cases an operation error occurs, the error flag (SM0) turns ON, and the error code is stored in SD0.
 - When the module attempting access is not a special function module. (Error code: 2110)
 - When AJ71QC24 control instructions cannot be used with the designated module. (Error code: 2112)
 - When the designated instruction name is illegal. (Error code: 4300)
 - When a non-designatable device is designated. (Error code: 4302)

Program Example

A program which turns M10 ON on execution of a PRR instruction for channel 1 of the AJ71QC24 installed at I/O numbers X/Y20 to X/Y3F is shown here.

[Ladder mode]

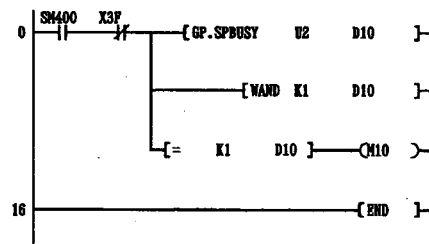

[List mode]

Step	Instruction	Device
0	LD	SM400
1	ANI	X3F
2	GP.SPBUSY	U2 D10
9	WAND	K1 D10
12	AND=	K1 D10
15	OUT	M10
16	END	

10.10 Reading Devices at Other Stations

Set Data	Usable Devices								
	Internal Device (System, User)		File Register	MELSECNET/10 Direct J-BUS		Special Function Module USER	Index Register zn	Constant	Other
	Bit	Word		Bit	Word				
(S1)	—	○					—		
(S2)	—	○					—		
(D1)	—	○					—		
(D2)	○	○					—		

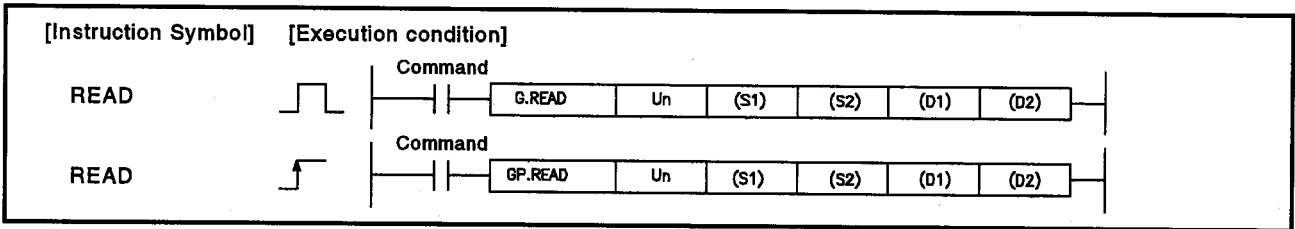

Set data

Set Data	Description	Data Type
Un	Head I/O number of host station AJ71QC24	16-bit binary
(S1)	First device number of devices storing control data	Device name
(S2)	First device number of devices of other station storing read data	
(D1)	First device number of devices of host station storing read data	
(D2)	Host station bit device turning ON at reading completion	Bit

Control data

	Setting Details	Setting Range	Data Set By											
		[Target Station-1]	User	System										
(S1)	<div style="text-align: center;"> <table border="1" style="margin: auto;"> <tr> <td style="padding: 2px;">b15</td> <td style="padding: 2px;">to</td> <td style="padding: 2px;">b7</td> <td style="padding: 2px;">to</td> <td style="padding: 2px;">b0</td> </tr> <tr> <td style="padding: 2px; text-align: center;">0</td> <td></td> <td style="padding: 2px; text-align: center;">1/0</td> <td></td> <td style="padding: 2px; text-align: center;">0</td> </tr> </table> </div> <p>Error completion type (bit 7) 0 : Not necessary to set the clock when error occurs Not necessary to set clock data when error occurs in (S1)+11 to (S1)+15. 1 : Necessary to set the clock when error occurs Necessary to set clock data when error occurs in (S1)+11 to (S1)+15. (Clock data controlled by error detection station)</p>	b15	to	b7	to	b0	0		1/0		0	0001H 0081H	○	
b15	to	b7	to	b0										
0		1/0		0										
(S1)+1	Completion status 0 : Normal end Other than 0: Error completion*	0 to		○										
(S1)+2	Channel used by host station Designates interface of host station AJ71QC24 sending request to read.	1 : CH 1 2 : CH 2	○											
(S1)+3	(Not used)	—	—	—										
(S1)+4	Target station network number	0	○											
(S1)+5	Target station number	0	○											
(S1)+6	Special Function Module station number When reading from [target station-1], designates target station AJ71QC24 station number (0 to 31).	0 to 31	○											
(S1)+7	Number of retransmissions Request to request : Designates number request is retransmitted when data cannot be read. Reading completed : Stores number of retransmissions for normal completion and error completion.	0 to 15	○	○										
(S1)+8	Arrival WDT time (unit: second) Designates WDT time until completion of execution of read instruction. When cannot read within the WDT time, repeats the read request (S1)+7 times. (Retransmission)	0 : default (10 secs) 1 to 32767: 1 to 32767 seconds	○											
(S1)+9	Length of read data (unit: word) Designates number of words of data read from the device designated at (S2).	1 to 480	○											
(S1)+10	(Not used)	—	—	—										
(S1)+11	Clock set flag When (S1) is 0081H (completion type for error is [1]), the validity or invalidity of data from (S1)+12 to (S1)+15 is stored.	0 : Invalid 1 : Valid		○										
(S1)+12	Year (last 2 digits), month when error occurred Upper 8 bits : year (00H to 99H) Lower 8 bits : month (01H to 12H)	0001H to 9912H		○										
(S1)+13	Day, hour when error occurred Upper 8 bits : day (01H to 31H) Lower 8 bits : hour (00H to 23H)	0100H to 3123H		○										
(S1)+14	Minute, second when error occurred Upper 8 bits : minute (00H to 59H) Lower 8 bits : second (00H to 59H)	0000H to 5959H		○										
(S1)+15	Day of the week when error occurred Day of the week (0000H: Sunday to 0006H: Saturday)	0000H to 0006H		○										
(S1)+16	Error detected network number	0		○										
(S1)+17	Error detected station number	0		○										

* : See the AJ71QC24 Serial Communication Module User's Manual

Function

- (1) Stores data of word devices starting from that designated at (S2) of the AJ71QC24 designated by the special function module station number in the control data, to devices starting from that designated at (D1) in the host station.
The completion device designated at (D2) turns ON when the reading of device data from the target station is completed.
- (2) AJ71QC24 control instructions cannot be executed simultaneously in two or more places for the same channel of the same AJ71QC24.
If the execution conditions come into effect simultaneously in 2 or more places, subsequently executed AJ71QC24 control instructions must wait until a channel becomes available.
To use AJ71QC24 control instructions using the same channel in 2 or more places, use the completion device as the communication start command, and conduct sequential execution.
- (3) Normal/error completion of read instructions can be confirmed by means of the completion device (D) or completion status indication device ((D)+1).
 - (a) Completion device
: Turns ON at END processing of scan completing READ instruction, and turns OFF at next END processing.
 - (b) Completion status indication device
: Turns ON/OFF depending on status at completion of READ instruction.
 - Normal completion : Stays OFF, no change.
 - Error completion : Turns ON at END processing of scan completing READ instruction, and turns OFF at next END processing.

[Operation at execution of READ instruction]

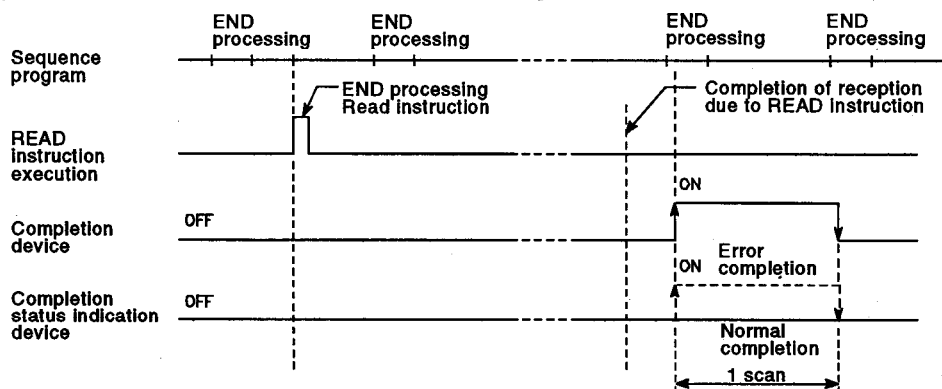

Operation Errors

- (1) In the following cases, an operation error occurs, the error flag (SM0) turns ON, and the error code is stored in SD0.
 - When the control data contents are outside the setting range. (Error code: 4100)
 - When the module attempting access is not a special function module. (Error code: 2110)
 - When AJ71QC24 control instructions cannot be used with the designated module. (Error code: 2112)
 - When the designated instruction name is illegal. (Error code: 4300)
 - When the number of AJ71QC24 control instruction devices is illegal. (Error code: 4301)
 - When a non-designatable device is designated. (Error code: 4302)

Program Example

A program which reads data from the AJ71QC24 of special function module station number 2, in a multidrop system, is shown here.

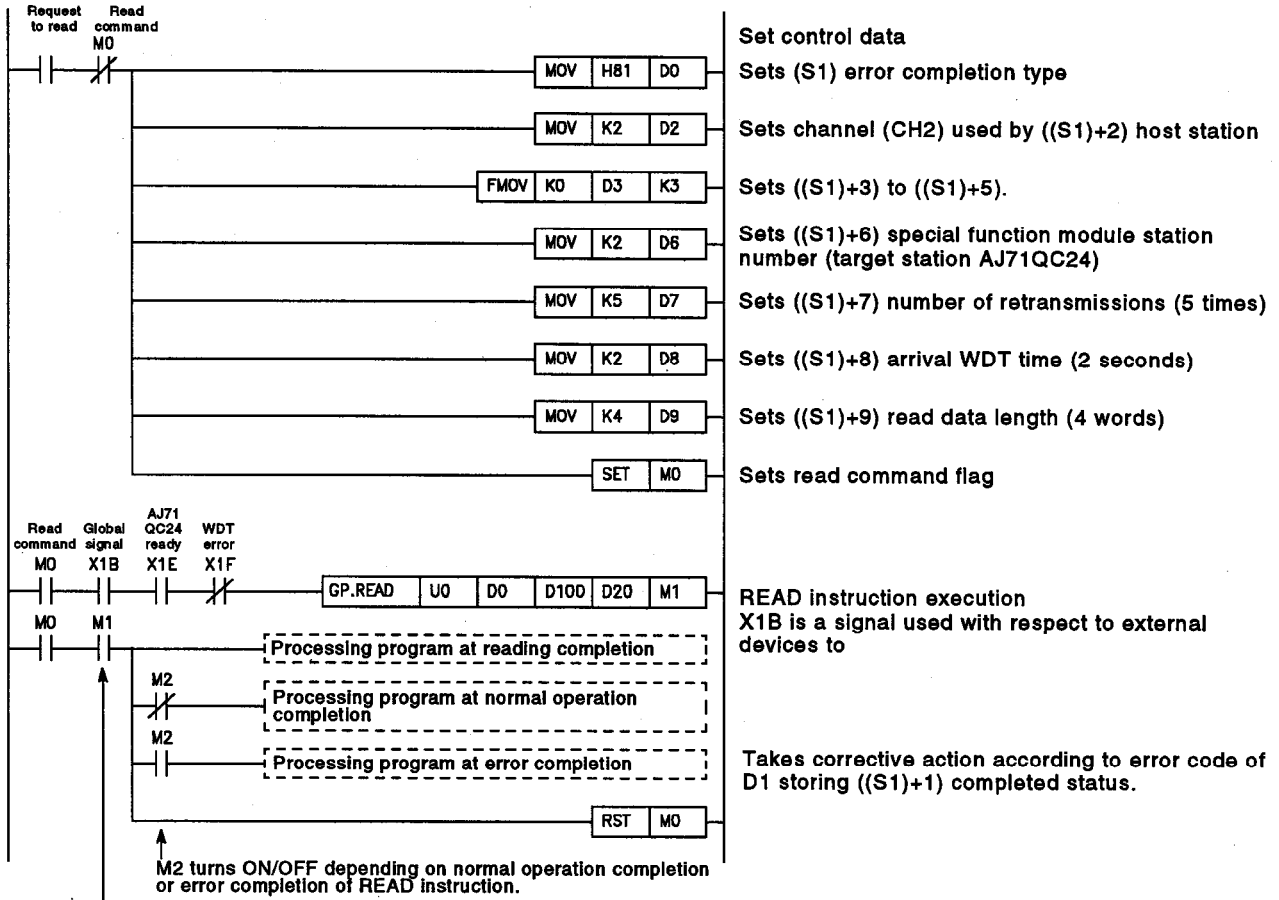

M1 turns ON for only 1 scan at completion of READ instruction execution.

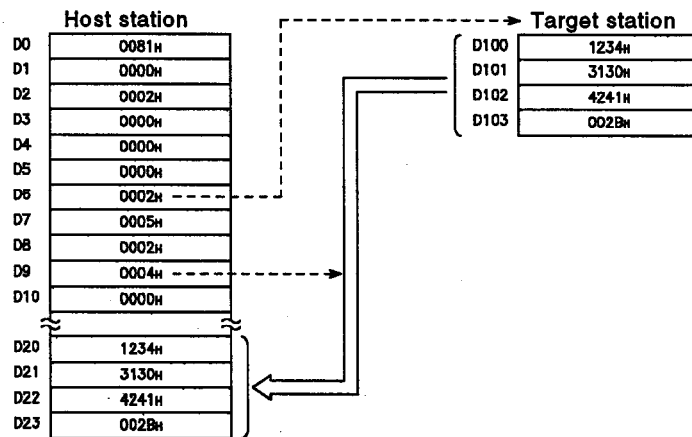

10.11 Writing to Other Station Devices

Set Data	Usable Devices								
	Internal Device (System, User)		File Register	MELSECNET/10 Direct JESAVE		Special Function Module UESAVE	Index Register Zn	Constant	Other
	Bit	Word		Bit	Word				
(S1)	—	○							
(S2)	—	○							
(D1)	—	○							
(D2)	○	○							
(D3)	○	○							

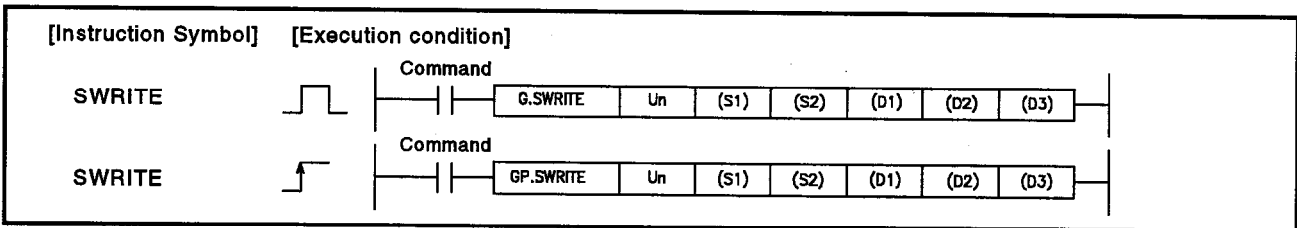

Set data

Set Data	Description	Data Type
Un	AJ71QC24 head I/O number	16-bit binary
(S1)	First device number of devices storing control data	Device name
(S2)	First device number of devices of host station storing write data	
(D1)	First device number of devices of other station storing write data	
(D2)	Bit device of host station turning ON at write completion	Bit
(D3)	Bit device of target station turning ON at write completion	

Control data

	Setting Details	Setting Range	Data Set By					
		[Target Station-1]	User	System				
(S1)	<p>b15 to b7 to b0</p> <table border="1"> <tr> <td>0</td> <td>1/0</td> <td>0</td> <td>1</td> </tr> </table> <p>Execution type (bit 0) 0 : No arrival confirmation Execution of SWRITE instruction is completed at completion of sending request to write. 1 : Arrival confirmation Execution of SWRITE instruction is completed at completion of writing data to write destination station.</p> <p>Error completion type (bit 7) 0 : Not necessary to set the clock when error occurs Not necessary to set clock data when error occurs in (S1)+11 to (S1)+15. 1 : Necessary to set the clock when error occurs Necessary to set clock data when error occurs in (S1)+11 to (S1)+15. (Clock data controlled by error detection station)</p>	0	1/0	0	1	0000H 0001H 0080H 0081H	○	
0	1/0	0	1					

	Setting Details	Setting Range	Data Set By	
		[Target Station-1]	User	System
(S1)+1	Completion status 0 : Normal end Other than 0: Error completion*	0 to		○
(S1)+2	Channel used by host station Designates interface of host station AJ71QC24 sending request to write.	1 : CH 1 2 : CH 2	○	
(S1)+3	(Not used)	—	—	—
(S1)+4	Target station network number	0	○	
(S1)+5	Target station number	0	○	
(S1)+6	Special function module station number Designates the target station AJ71QC24 station number (0 to 31) when writing to [target station -1].	0 to 31	○	
(S1)+7	Number of retransmissions Write request : Designates the number of retransmissions when data cannot be written when (S1) is 0001H/0081H (execution type is "1"). Write completed: Stores number of retransmissions for normal completion and error completion.	0 to 15	○	○
(S1)+8	Arrival WDT time (unit: second) Designates WDT time until end of execution of SWRITE instruction when (S1) is 0001H/0081H (execution type is "1"). When data cannot be written within the WDT time, the write request is repeated (S1)+7 times. (Retransmission)	0 : default (10 secs) 1 to 32767 : 1 to 32767 seconds	○	
(S1)+9	Length of write data (unit: word) Designates number of words when writing data of device designated at (S2).	1 to 480	○	
(S1)+10	(Not used)	—	—	—
(S1)+11	Clock set flag When (S1) is 0080H/0081H (error completion type is "1"), the validity or invalidity of data from (S1)+12 to (S1)+15 is stored.	0 : Invalid 1 : Valid		○
(S1)+12	Year (last 2 digits), month when error occurred Upper 8 bits : year (00H to 99H) Lower 8 bits : month (01H to 12H)	0001H to 9912H		○
(S1)+13	Day, hour when error occurred Upper 8 bits : day (01H to 31H) Lower 8 bits : hour (00H to 23H)	0100H to 3123H		○
(S1)+14	Minute, second when error occurred Upper 8 bits : minute (00H to 59H) Lower 8 bits : second (00H to 59H)	0000H to 5959H		○
(S1)+15	Day of the week when error occurred Day of the week (0000H: Sunday to 0006H: Saturday)	0000H to 0006H		○
(S1)+16	Error detected network number	0		○
(S1)+17	Error detected station number	0		○

REMARK

1)* : See the following manual for details about error codes when operation is ended with an error.
AJ71QC24 Serial Communication Module User's Manual.

Function

- (1) Stores data stored in devices starting from that designated at (S2) to the word devices of the AJ71QC24 designated by the special function module station number in the control data, starting from the device designated at (D1).
The completion device designated at (D2) turns ON when writing of the device data to the target station is completed.
- (2) AJ71QC24 control instructions cannot be executed simultaneously in two or more places for the same channel of the same AJ71QC24.
If the execution conditions come into effect simultaneously in 2 or more places, subsequently executed AJ71QC24 control instructions must wait until a channel becomes available.
To use AJ71QC24 control instructions using the same channel in 2 or more places, use the completion device in communication start commands, and conduct sequential execution.
- (3) An interlock signal for use at execution of the WRITE instruction can be established with the completion device ((D2)) or the completion status indication device ((D2)+1).
 - (a) Host station completion device
: Turns ON at END processing of scan completing WRITE instruction, and turns OFF at next END processing.
 - (b) Completion status indication device
: Turns ON/OFF depending on status at time of completion of WRITE instruction.
 - Normal completion : Stays OFF, no change.
 - Error completion : Turns ON at END processing of scan completing WRITE instruction, and turns OFF at next END processing.
 - (c) Target station completion device
: Turns ON at END processing of scan completing WRITE instruction, and turns OFF at next END processing.

[Operation at execution of WRITE instruction]

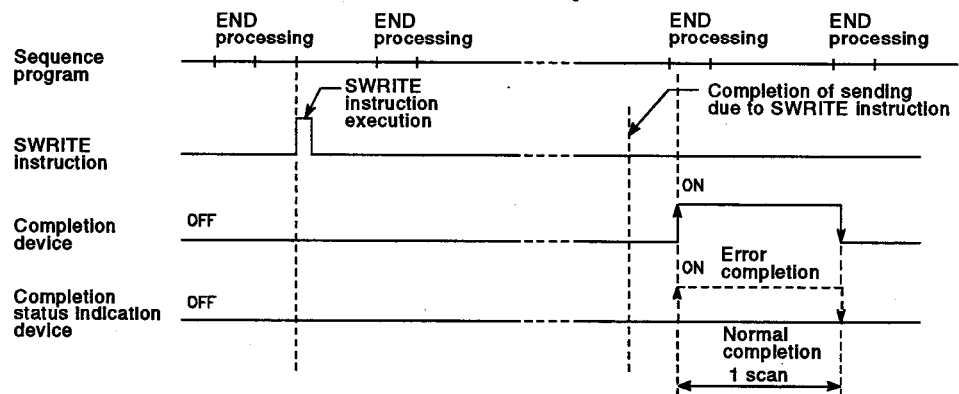

[Target station operation at WRITE execution]

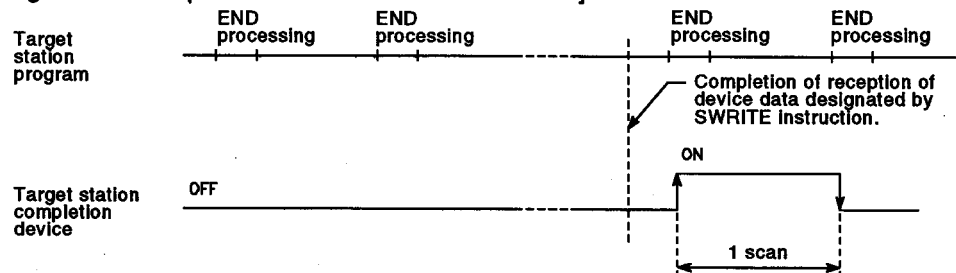

Operation Errors

- (1) In the following cases, an operation error occurs, the error flag (SM0) turns ON, and the error code is stored in SD0.
- When the control data contents are outside the setting range. (Error code: 4100)
 - When the module attempting access is not a special function module. (Error code: 2110)
 - When AJ71QC24 control instructions cannot be used with the designated module. (Error code: 2112)
 - When the designated instruction name is illegal. (Error code: 4300)
 - When the number of AJ71QC24 control instruction devices is illegal. (Error code: 4301)
 - When a non-designatable device is designated. (Error code: 4302)

Program Example

A program which writes data to the AJ71QC24 of special function module station number 2, in a multidrop system, is shown here.

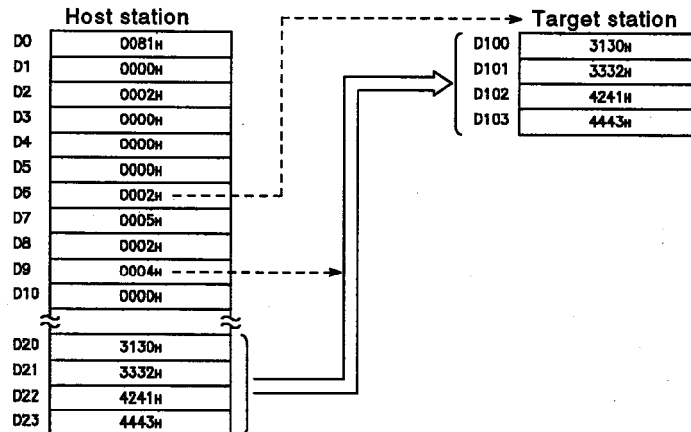
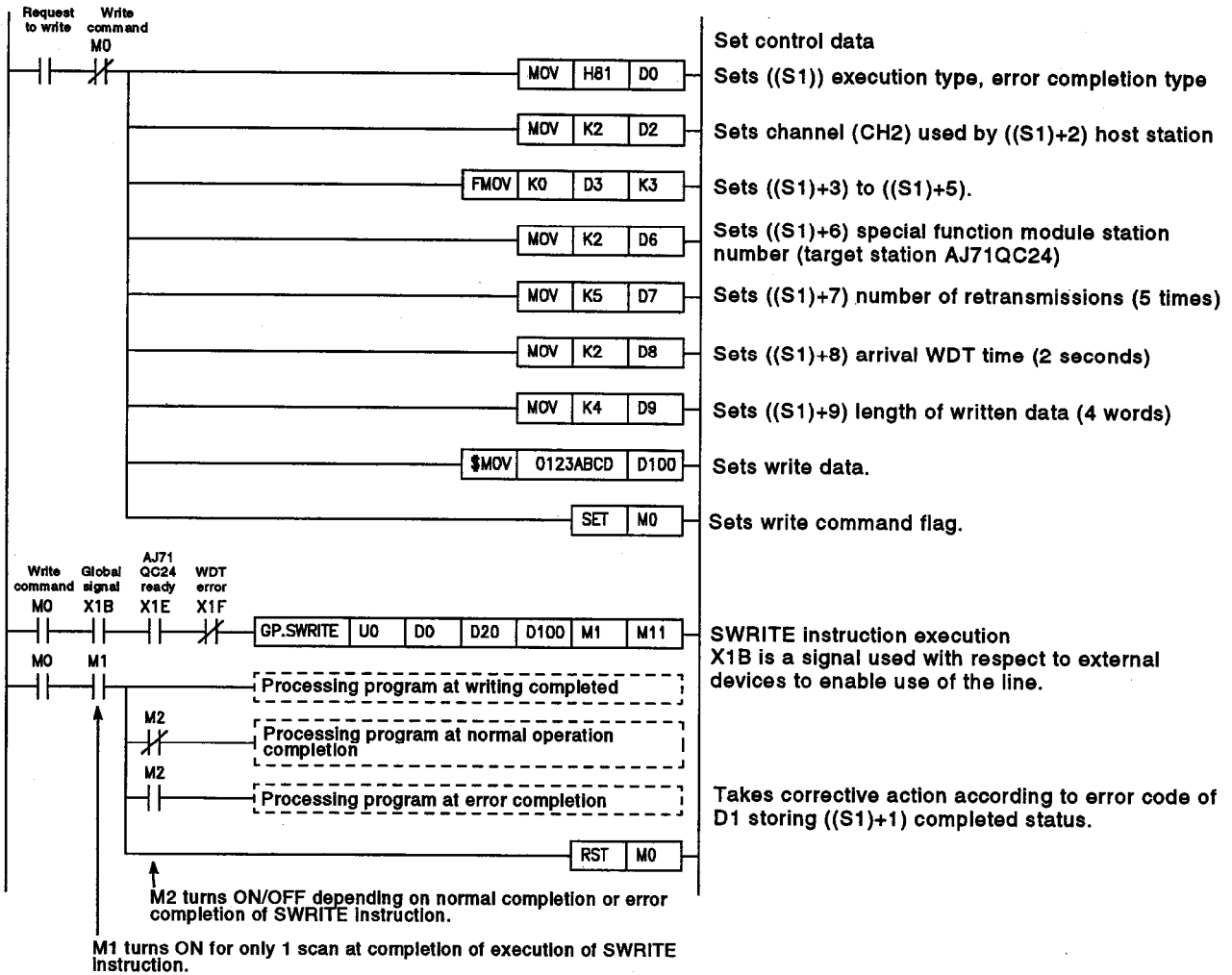

10.12 Sending Data to Other Stations

Set Data	Usable Devices								
	Internal Device (System, User)		File Register	MELSECNET/10 Direct J-BUS		Special Function Module USING	Index Register Zn	Constant	Other
	Bit	Word		Bit	Word				
(S1)	—	○							
(S2)	—	○							
(D)	○	○							

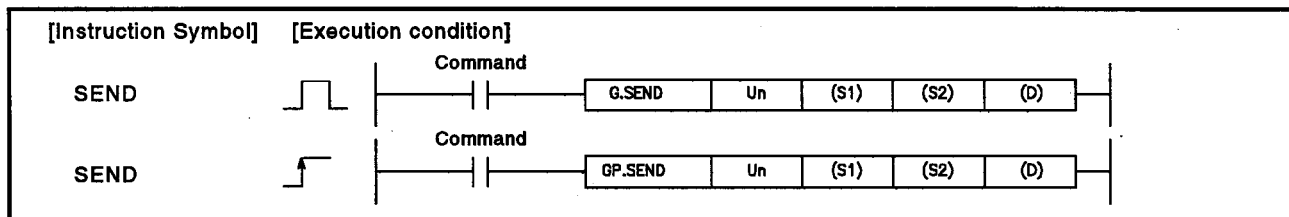

Set data

Set Data	Description	Data Type
Un	Head I/O number of host station AJ71QC24	16-bit binary
(S1)	First device number of devices storing control data	Device name
(S2)	First device number of devices storing send data	
(D)	Bit device number turning ON at completion of sending	Bit

Control data

	Setting Details	Setting Range	Data Set By	
		[Target Station-1]	User	System
(S1)	<p>b15 to b7 to b0</p> <p>0 1/0 0 1/0</p> <p>Execution type (bit 0) 0 : No arrival confirmation Execution of the SEND instruction is ended on completing transmission of the send data. 1 : Arrival confirmation Execution of the SEND instruction is ended on arrival of the send data at the send destination station.</p> <p>Error completion type (bit 7) 0 : Not necessary to set the clock when error occurs Not necessary to set clock data when error occurs in (S1)+11 to (S1)+15. 1 : Necessary to set the clock when error occurs Necessary to set clock data when error occurs in (S1)+11 to (S1)+15. (Clock data controlled by error detection station)</p>	0000H 0001H 0080H 0081H	○	
(S1)+1	Completion status 0 : Normal end Other than 0 : Error completion*	0 to		○
(S1)+2	Channel used by host station Designates the interface of the host station AJ71QC24 sending data.	1 : CH 1 2 : CH 2	○	
(S1)+3	Target station storing channel Designates the interface of send destination station AJ71QC24 sending data at the same interface as (S1)+2 above.	1 : CH 1 2 : CH 2	○	

	Setting Details	Setting Range	Data Set By	
		[Target Station-1]	User	System
(S1)+4	Target station network number	0	○	
(S1)+5	Target station number	0	○	
(S1)+6	Special function module station number Designates target station AJ71QC24 station number (0 to 31) when sending to [target station -1].	0 to 31	○	
(S1)+7	Number of retransmissions Send request : Designates the number of retransmissions when data cannot be sent when (S1) is 0001H/0081H (execution type is [1]). Send completion : Stores number of retransmissions for normal completion and error completion.	0 to 15	○	○
(S1)+8	Arrival WDT time (unit: second) Designates the WDT time until completion of execution of SEND instruction when (S1) is 0001H/0081H (execution type is [1]). Retransmits (S1)+7 number of times when cannot send within the WDT time.	0 : default (10 secs) 1 to 32767 : 1 to 32767 seconds	○	
(S1)+9	Length of send data (unit: word) Designates the number of send data designated at (S2).	1 to 480	○	
(S1)+10	(Not used)	—	—	—
(S1)+11	Clock set flag When (S1) is 0080H/0081H (error completion type is [1]), the validity or invalidity of data from (S1)+12 to (S1)+15 is stored.	0 : Invalid 1 : Valid		○
(S1)+12	Year (last 2 digits), month when error occurred Upper 8 bits : year (00H to 99H) Lower 8 bits : month (01H to 12H)	0001H to 9912H		○
(S1)+13	Day, hour when error occurred Upper 8 bits : day (01H to 31H) Lower 8 bits : hour (00H to 23H)	0100H to 3123H		○
(S1)+14	Minute, second when error occurred Upper 8 bits : minute (00H to 59H) Lower 8 bits : second (00H to 59H)	0000H to 5959H		○
(S1)+15	Day of the week when error occurred Day of the week (0000H: Sunday to 0006H: Saturday)	0000H to 0006H		○
(S1)+16	Error detected network number	0		○
(S1)+17	Error detected station number	0		○

[Note]

- 1) AJ71QC24 can only store the data sent by SEND instruction once. Wherever possible, execute the send instruction so that there is arrival confirmation.
- 2) Prepare contiguous areas with the following numbers of words for the word devices used with SEND instruction.
 - (S1) (Control data storage device) 18 words
 - (S1) (Send data storage first device)... (S1)+9 (send data length) designation

REMARK

- 1)*: See the following manual for details about error codes at error end.
AJ71QC24 Serial Communication Module User's Manual.

Function

- (1) Sends the data of word devices starting from that designated at (S2) to the designated channel in the AJ71QC24 designated by the special function module station number in the control data.
- (2) AJ71QC24 control instructions cannot be executed simultaneously in two or more places for the same channel of the same AJ71QC24. If the execution conditions come into effect simultaneously in 2 or more places, subsequently executed AJ71QC24 control instructions must wait until a channel becomes available. To use AJ71QC24 control instructions using the same channel in 2 or more places, use the completion device in communication start commands, and conduct sequential execution.
- (3) An interlock signal for use at execution of the SEND instruction can be established with the completion device ((D2)) or the completion status indication device ((D2)+1).
 - (a) Host station completion device
 - : Turns ON at END processing of scan completing reading due to the SEND instruction, and turns OFF at next END processing.
 - (b) Completion status indication device
 - : Turns ON/OFF depending on the status on completing SEND instruction.
 - Normal completion : Stays OFF, no change.
 - Error completion : Turns ON at END processing of scan completing SEND instruction, and turns OFF at next END processing.

[Operation at execution of SEND instruction]

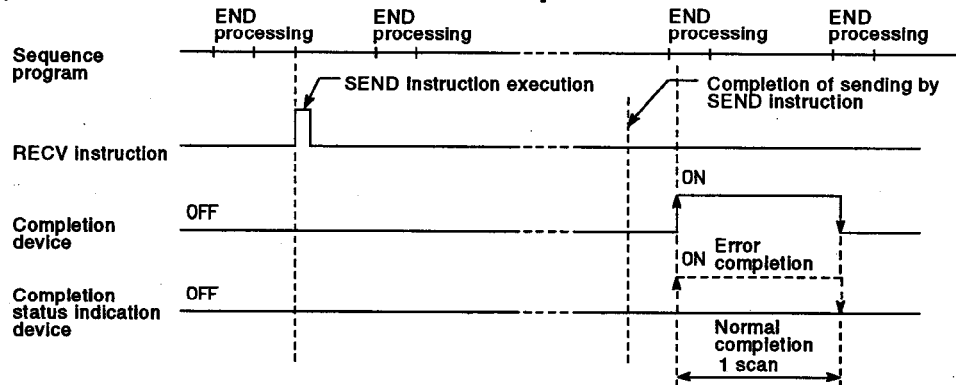

Operation Errors

- (1) In the following cases, an operation error occurs, the error flag (SM0) turns ON, and the error code is stored in SD0.
 - When the control data contents are outside the setting range. (Error code: 4100)
 - When the module attempting access is not a special function module. (Error code: 2110)
 - When AJ71QC24 control instructions cannot be used with the designated module. (Error code: 2112)
 - When the designated instruction name is illegal. (Error code: 4300)
 - When the number of AJ71QC24 control instruction devices is illegal. (Error code: 4301)
 - When a non-designatable device is designated. (Error code: 4302)

Program Example

A program which transmits data to the AJ71QC24 whose special function module station number is 2 is shown here.

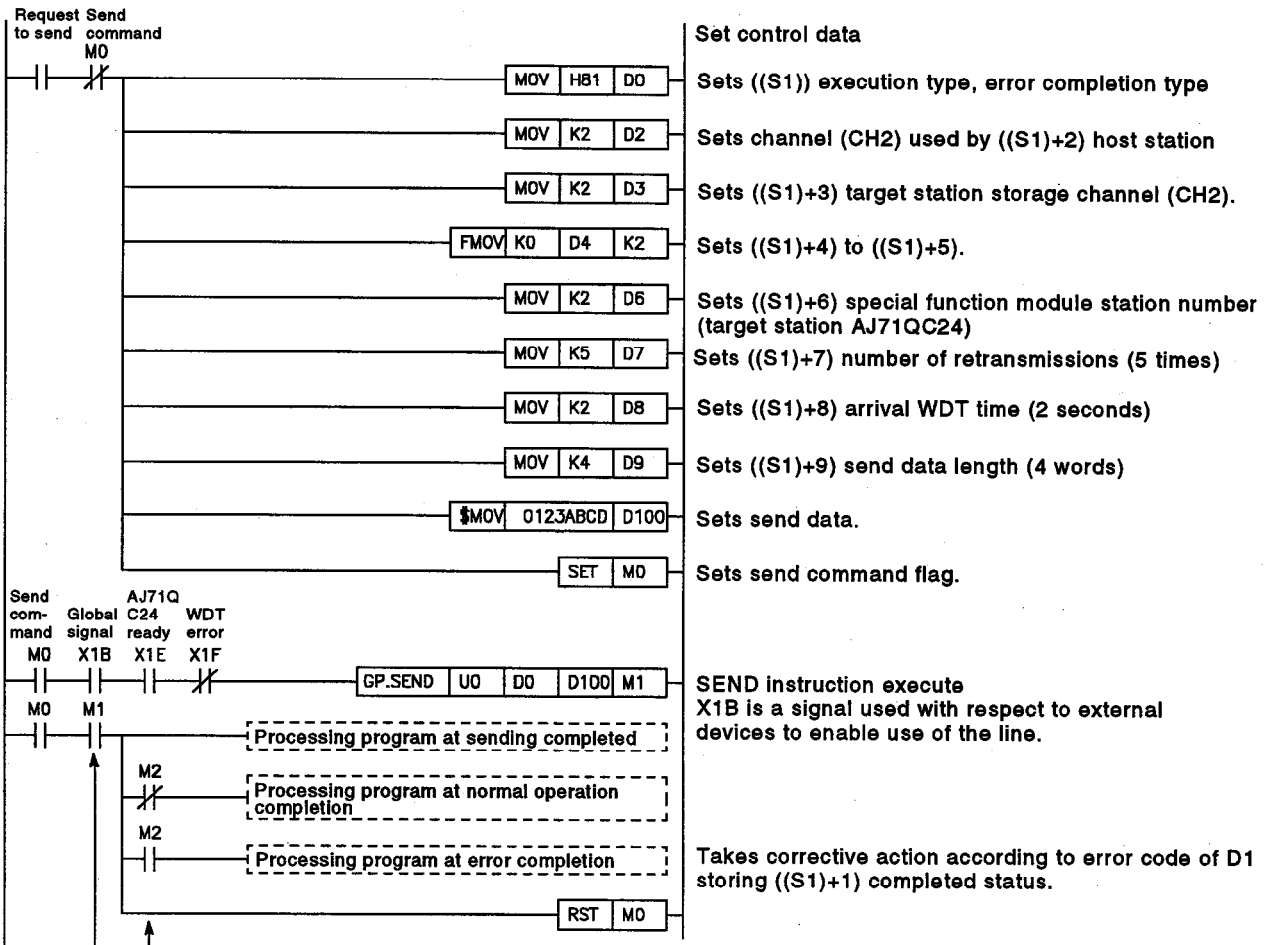

M2 turns ON/OFF depending on normal operation end/error end of SEND instruction.
M1 turns ON for only 1 scan at completion of execution of SEND instructions.

10.13 Receiving Data from Other Stations

Set Data	Usable Devices								
	Internal device (System, User)		File Register	MELSECNET/10 Direct J(□)□□		Special Function Module U(□)G(□)	Index Register Zn	Constant	Other
	Bit	Word		Bit	Word				
(S)	—	○							
(D1)	—	○							
(D2)	○	○							

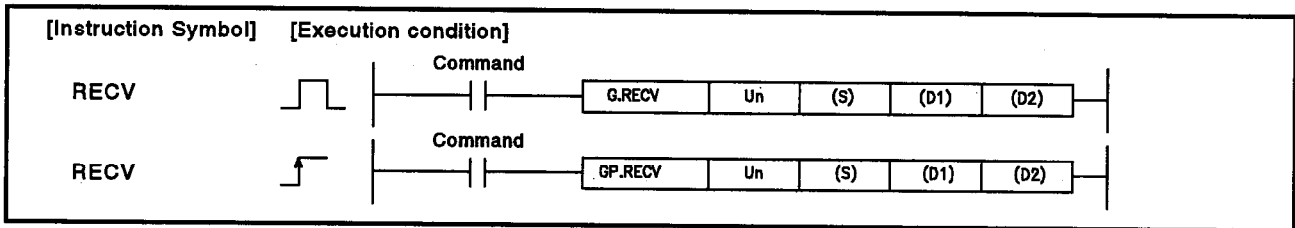

Set data

Set Data	Description	Data Type
Un	Head I/O number of host station AJ71QC24	16-bit binary
(S)	First device number of devices storing control data	Device name
(D1)	First device number of devices storing received data	
(D2)	Bit device number turning ON at receive completion	Bit

Control data

	Setting Details	Setting Range	Data Set By											
		[Target Station-1]	User	System										
(S1)	<div style="text-align: center;"> <table border="1" style="margin: auto;"> <tr> <td style="width: 20px;">b15</td> <td style="width: 20px;">to</td> <td style="width: 20px;">b7</td> <td style="width: 20px;">to</td> <td style="width: 20px;">b0</td> </tr> <tr> <td style="text-align: center;">0</td> <td></td> <td style="text-align: center;">1/0</td> <td></td> <td style="text-align: center;">0</td> </tr> </table> </div> <p>Error completion type (bit 7) 0 : Not necessary to set the clock when error occurs Not necessary to set clock data when error occurs in (S1)+11 to (S1)+15. 1 : Necessary to set the clock when error occurs Necessary to set clock data when error occurs in (S1)+11 to (S1)+15. (Clock data controlled by error detection station)</p>	b15	to	b7	to	b0	0		1/0		0	0000H 0080H	○	
b15	to	b7	to	b0										
0		1/0		0										
(S1)+1	Completion status 0 : Normal end Other than 0 : Error end	0 to		○										
(S1)+2	Channel used by host station Designates the AJ71QC24 interface number reading received data	1 : CH 1 2 : CH 2	○											
(S1)+3	Send source station channel Stores the number of the AJ71QC24 interface sending the send source station data	1 : CH 1 2 : CH 2		○										
(S1)+4	Send source station network number	0		○										
(S1)+5	Send source station number	0		○										
(S1)+6	(Not used)	—	—	—										
(S1)+7														
(S1)+8	Arrival WDT time (unit: second) Designates the WDT time until execution end of RECV instruction. Error ends when cannot receive data within the WDT time.	0 : default (10 secs) 1 to 32767 : 1 to 32767 seconds	○											
(S1)+9	Length of received data (unit: word) Stores the number of words of received data stored in device designated at (S2).	1 to 480		○										
(S1)+10	(Not used)	—	—	—										
(S1)+11	Clock set flag Stores the validity/invalidity of data in (S1)+12 to (S1)+15, when (S1) is 0080H (the error end type is [1]).	0 : Invalid 1 : Valid		○										
(S1)+12	Year (last 2 digits), month when error occurred Upper 8 bits : year (00H to 99H) Lower 8 bits : month (01H to 12H)	0001H to 9912H		○										
(S1)+13	Day, hour when error occurred Upper 8 bits : day (01H to 31H) Lower 8 bits : hour (00H to 23H)	0100H to 3123H		○										
(S1)+14	Minute, second when error occurred Upper 8 bits : minute (00H to 59H) Lower 8 bits : second (00H to 59H)	0000H to 5959H		○										
(S1)+15	Day of the week when error occurred Day of the week (0000H: Sunday to 0006H: Saturday)	0000H to 0006H		○										

Function

- (1) Stores data sent by SEND Instruction from the control data host channel of the AJ71QC24 designated at Un, to word devices starting from that designated at (S2).
- (2) AJ71QC24 control instructions cannot be executed simultaneously in two or more places for the same channel of the same AJ71QC24. If the execution conditions come into effect simultaneously in 2 or more places, subsequently executed AJ71QC24 control instructions must wait until a channel becomes available. To use AJ71QC24 control instructions using the same channel in 2 or more places, use the completion device in communication start commands, and conduct sequential execution.
- (3) An interlock signal for use at execution of the RECV instruction can be established with the completion device ((D2)) or the completion status indication device ((D2)+1).
 - (a) Host station completion device
 - : Turns ON at END processing of scan completing the RECV instruction, and turns Off at next END processing.
 - (b) Completion status indication device
 - : Turns ON/OFF depending on status on ending RECV instruction.
 - Normal completion : Stays OFF, no change.
 - Error completion : Turns ON at END processing of scan ending RECV instruction, and turns OFF at next END processing.

[Operation at execution of RECV instruction]

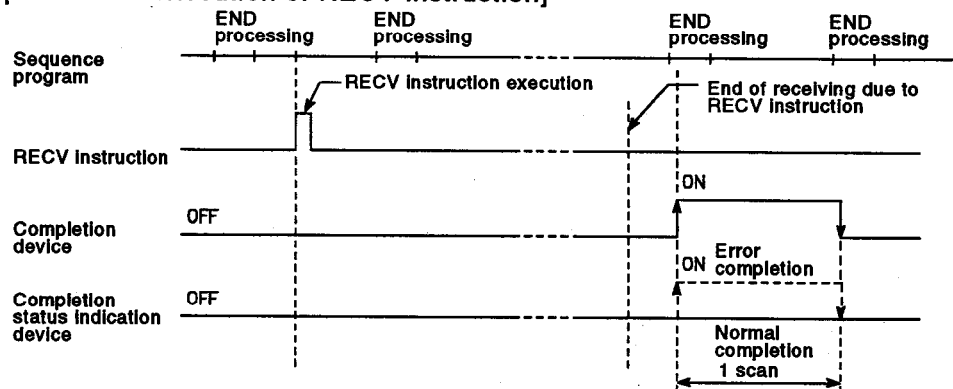

Operation Errors

- (1) In the following cases, an operation error occurs, the error flag (SM0) turns ON, and the error code is stored in SD0.
 - When the control data contents are outside the setting range. (Error code: 4100)
 - When the module attempting access is not a special function module. (Error code: 2110)
 - When AJ71QC24 control instructions cannot be used with the designated module. (Error code: 2112)
 - When the designated instruction name is illegal. (Error code: 4300)
 - When the number of AJ71QC24 control instruction devices is illegal. (Error code: 4301)
 - When a non-designatable device is designated. (Error code: 4302)

Program Example

(1) A program which reads data written by the SEND instruction to channel 2 of the AJ71QC24 installed at X/Y10 to X/Y2F, to D300 onwards, is shown here.

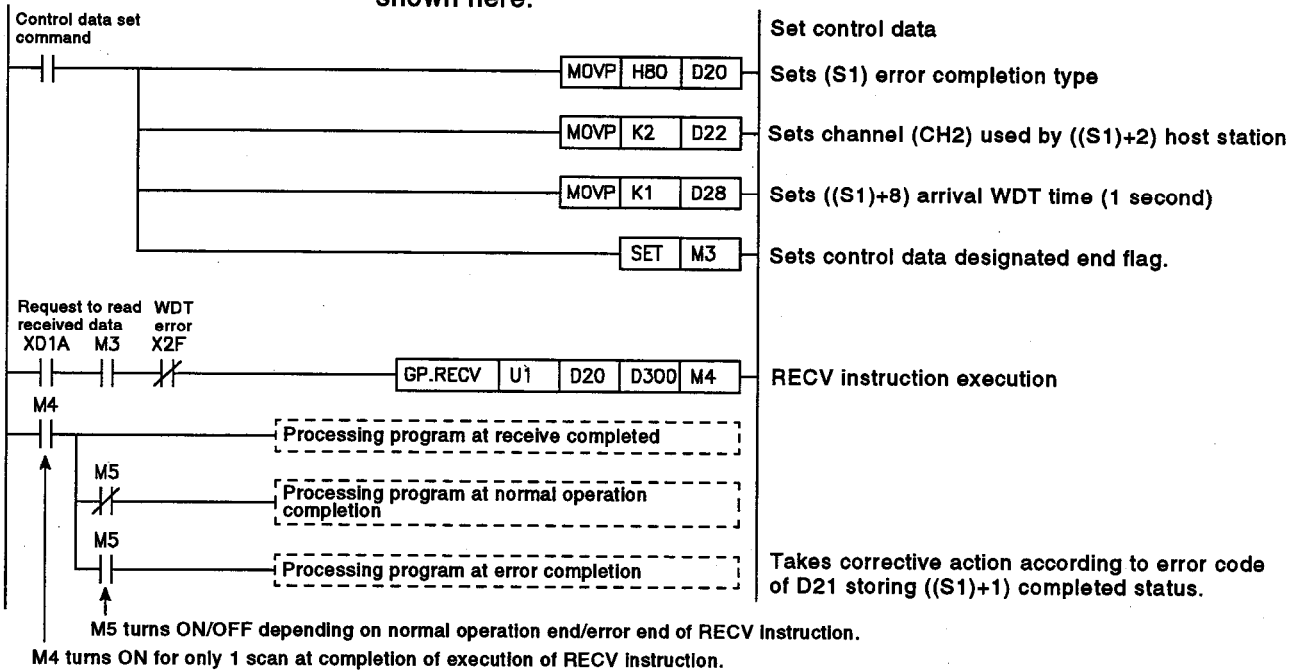

10.14 Other Station Transient Transmission Request

Set Data	Usable Devices								
	Internal Device (System, User)		File Register	MELSECNET/10 Direct J□□□		Special Function Module U□□□□	Index Register Zn	Constant	Other
	Bit	Word		Bit	Word				
(S1)	—	○					—		
(S2)	—	○					—		
(D1)	—	○					—		
(D2)	○	○					—		

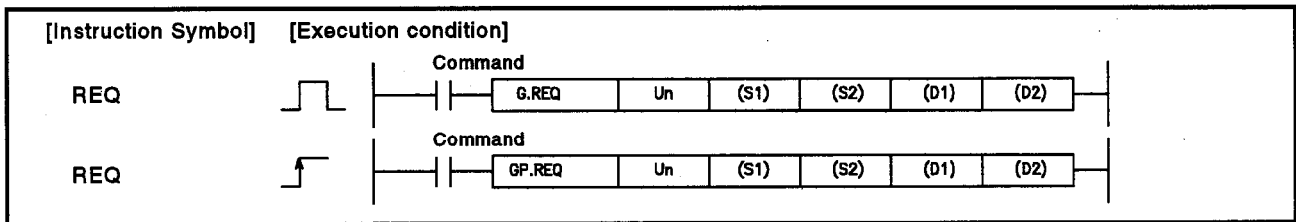

Set data

Set Data	Description	Data Type
Un	AJ71QC24 head I/O number	16-bit binary
(S1)	First device number of devices storing control data	Device name
(S2)	First device number of devices storing request data	
(D1)	First device number of devices storing response data	
(D2)	Bit device turning ON at execution completion	Bit

Control data

	Setting Details	Setting Range	Data Set By							
		[Target Station-1]	User	System						
	b15 to b7 to b4 to b0 <table border="1" style="margin-left: 20px;"> <tr> <td style="width: 20px;">0</td> <td style="width: 20px;">1/0</td> <td style="width: 20px;">0</td> <td style="width: 20px;">1</td> <td style="width: 20px;">0</td> <td style="width: 20px;">1</td> </tr> </table>	0	1/0	0	1	0	1			
0	1/0	0	1	0	1					
(S1)	Error completion type (bit 7) 0 : Not necessary to set the clock when error occurs Not necessary to set clock data when error occurs in (S1)+11 to (S1)+15. 1 : Necessary to set the clock when error occurs Necessary to set clock data when error occurs in (S1)+11 to (S1)+15. (Clock data controlled by error detection station)	0011H 0091H	○							
(S1)+1	Completion status 0 : Normal end Other than 0 : Error end	0 to		○						
(S1)+2	Channel used by host station Designates host station AJ71QC24 interface sending the request.	1 : CH 1 2 : CH 2	○							
(S1)+3	Target station I/O signal	03FFH	○							
(S1)+4	Target station network number	0	○							
(S1)+5	Target station number	0	○							
(S1)+6	Special function module station number Designates target station AJ71QC24 station number (0 to 31) when sending request to [target station -1]	0 to 31	○							
(S1)+7	Number of retransmissions Read/write request : Designates the number of times to retransmit the request when cannot read/write. Read/write completed : Stores number of retransmissions for normal completion and error completion.	0 to 15	○							
(S1)+8	Arrival WDT time (unit: second) Designates WDT time until completion of execution of REQ instruction. Repeats transmission of request (S1)+7 number of times when cannot receive response within the WDT time. (Retransmission)	0 : default (10 secs) 1 to 32767 : 1 to 32767 seconds	○							
(S1)+9	Length of send data (unit: word) Designates number of words in data designated at (S2).	2 : Reading 7 : Writing	○							
(S1)+10	Length of received data (unit: word) When reading clock data, stores the number of words of data written in the device designated at (D1). When writing clock data, designates (S1)+10 as a dummy.	4 : Reading 0 : Writing		○						
(S1)+11	Clock set flag When (S1) is 0091H (completion type for error is [1]), the validity or invalidity of data from (S1)+12 to (S1)+15 is stored.	0 : Invalid 1 : Valid		○						
(S1)+12	Year (last 2 digits), month when error occurred Upper 8 bits : year (00H to 99H) Lower 8 bits : month (01H to 12H)	0001H to 9912H		○						
(S1)+13	Day, hour when error occurred Upper 8 bits : day (01H to 31H) Lower 8 bits : hour (00H to 23H)	0100H to 3123H		○						
(S1)+14	Minute, second when error occurred Upper 8 bits : minute (00H to 59H) Lower 8 bits : second (00H to 59H)	0000H to 5959H		○						

(continued)

	Setting Details	Setting Range	Data Set By	
		[Target Station-1]	User	System
(S1)+15	Day of the week when error occurred Day of the week (0000H: Sunday to 0006H: Saturday)	0000H to 0006H		○
(S1)+16	Error detected network number	0		○
(S1)+17	Error detected station number	0		○

Request data

(1) Remote RUN/STOP

	Setting Details	Setting Range	Data Set By	
		[Target Station-1]	User	System
(S2)	Remote control	0010H	○	
(S2)+1	Remote control request content Designates contents of request for remote control.	0001H : Remote RUN 0003H : Remote STOP	○	
(S2)+2	Mode *1 During remote RUN, designates whether or not to forcibly RUN. Designates 0001H in remote STOP.	0001H : Does not forcibly execute 0002H : Forcibly executes	○	
(S2)+3	Clear mode *2 During remote RUN, designates whether or not to clear QnACPU device memory (ie. initializing). Designates 0000H in remote STOP.	0000H : Does not clear 0001H : Clears (except latch range) 0002H : Clears (including latch range)	○	

- *1 Mode ((S2)+2) contains data for the forced execution of remote RUN. If it is not possible to forcibly execute remote RUN at the QnACPU whose status is being controlled because of trouble at the station requesting QnACPU remote STOP/PAUSE, or at external devices, etc., use other devices to forcibly conduct remote RUN.
- *2 Clear mode ((S2)+3) contains data for designating clear processing (initialization) of the QnACPU device memory at the start of QnACPU operations by remote RUN. The QnACPU RUNS according to the parameter setting (PC file setting → device initial value) after the designated clearance.

(2) Reading/writing clock data

	Setting Details	Setting Range	Data Set By									
		[Target Station-1]	User	System								
(S2)	System reading/writing	0001H : Read 0011H : Write	○									
(S2)+1	Request content Designates contents of request for system reading/writing.	0002H : Read clock 0001H : Write clock	○									
(S2)+2	<p>Change pattern</p> <p>Writing clock data: Bits are turned ON in correspondence with the clock data written by (S2)+3 to (S2)+6. (S2)+3 to (S2)+6 data that corresponds to ON bits is valid.</p> <p>Reading clock data: (S2)+2 to (S2)+6 does not require designation</p> <div style="display: flex; align-items: center;"> <div style="margin-right: 20px;"> <p>b15 to b6 b5 b4 b3 b2 b1 b0</p> <table border="1" style="border-collapse: collapse; text-align: center;"> <tr> <td style="width: 40px;">0</td> <td style="width: 10px;">1/0</td> <td style="width: 10px;">1/0</td> <td style="width: 10px;">1/0</td> <td style="width: 10px;">1/0</td> <td style="width: 10px;">1/0</td> <td style="width: 10px;">1/0</td> <td style="width: 10px;">1/0</td> </tr> </table> </div> <div> <p>1: Writes (changes) 0: Do not write (Does not change)</p> <div style="display: flex; justify-content: space-around; margin-top: 10px;"> <div style="text-align: center;"> <p>Day of the week</p> <p>second</p> <p>minute</p> </div> <div style="text-align: center;"> <p>hour</p> <p>day</p> <p>month</p> <p>year</p> </div> </div> </div> </div>	0	1/0	1/0	1/0	1/0	1/0	1/0	1/0	0001H to 007FH	○	
0	1/0	1/0	1/0	1/0	1/0	1/0	1/0					
(S2)+3	Changing month, year (last 2 digits) Upper 8 bits : month (01H to 12H) Lower 8 bits : year (00H to 99H)	0100H to 1299H	○									
(S2)+4	Changing hour, day Upper 8 bits : hour (00H to 23H) Lower 8 bits : day (01H to 31H)	0001H to 2331H	○									
(S2)+5	Changing second, minute Upper 8 bits : second (00H to 59H) Lower 8 bits : minute (00H to 59H)	0000H to 5959H	○									
(S2)+6	Changing day of the week Day of the week (0000H: Sunday to 0006H: Saturday)	0000H to 0006H	○									

[Note]

- 1) Clock data cannot be written when the target QnACPU is system protected (when system protect switch SW5 is ON).
Each request is error completed.

Response data

(1) Reading clock data

	Setting Details	Setting Range	Data Set By	
		[Target Station-1]	User	System
(D1)	Read month, year (last 2 digits) Upper 8 bits : month (01H to 12H) Lower 8 bits : year (00H to 99H)	0100H to 1299H		○
(D1)+1	Read hour, day Upper 8 bits : hour (00H to 23H) Lower 8 bits : day (01H to 31H)	0001H to 2331H		○
(D1)+2	Read second, minute Upper 8 bits : second (00H to 59H) Lower 8 bits : minute (00H to 59H)	0000H to 5959H		○
(D1)+3	Read day of the week Day of the week (0000H: Sunday to 0006H: Saturday)	0000H to 0006H		○

Function

- (1) Sends the request data from (S1) onwards to AJ71QC24 designated at control data special function module station number.
- (2) AJ71QC24 control instructions cannot be executed simultaneously in two or more places for the same channel of the same AJ71QC24. If the execution conditions come into effect simultaneously in 2 or more places, subsequently executed AJ71QC24 control instructions must wait until a channel becomes available. To use AJ71QC24 control instructions using the same channel in 2 or more places, use the completion device in communication start commands, and conduct sequential execution.
- (3) An interlock signal for use at execution of the REQ instruction can be established with the completion device ((D2)) or the completion status indication device ((D2)+1).
 - (a) Host station completion device
: Turns ON at END processing of scan completing reading due to the REQ instruction, and turns OFF at next END processing.
 - (b) Completion status indication device
: Turns ON/OFF depending on the status on completing REQ instruction
 - Normal completion : Stays OFF, no change.
 - Error completion : Turns ON at END processing of scan completing REQ instruction, and turns OFF at next END processing.

[Operation at execution of REQ instruction]

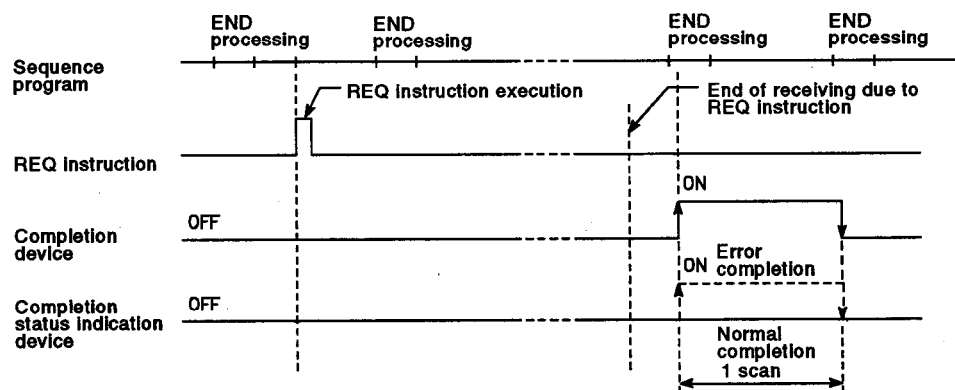

Operation Errors

- (1) In the following cases, an operation error occurs, the error flag (SM0) turns ON, and the error code is stored in SD0.
 - When the control data contents are outside the setting range. (Error code: 4100)
 - When the module attempting access is not a special function module. (Error code: 2110)
 - When AJ71QC24 control instructions cannot be used with the designated module. (Error code: 2112)
 - When the designated instruction name is illegal. (Error code: 4300)
 - When the number of AJ71QC24 control instruction devices is illegal. (Error code: 4301)
 - When a non-designatable device is designated. (Error code: 4302)

Program Example

A program which remote STOPS the AJ71QC24 whose special function module station number is 2 in a multidrop system is shown here.

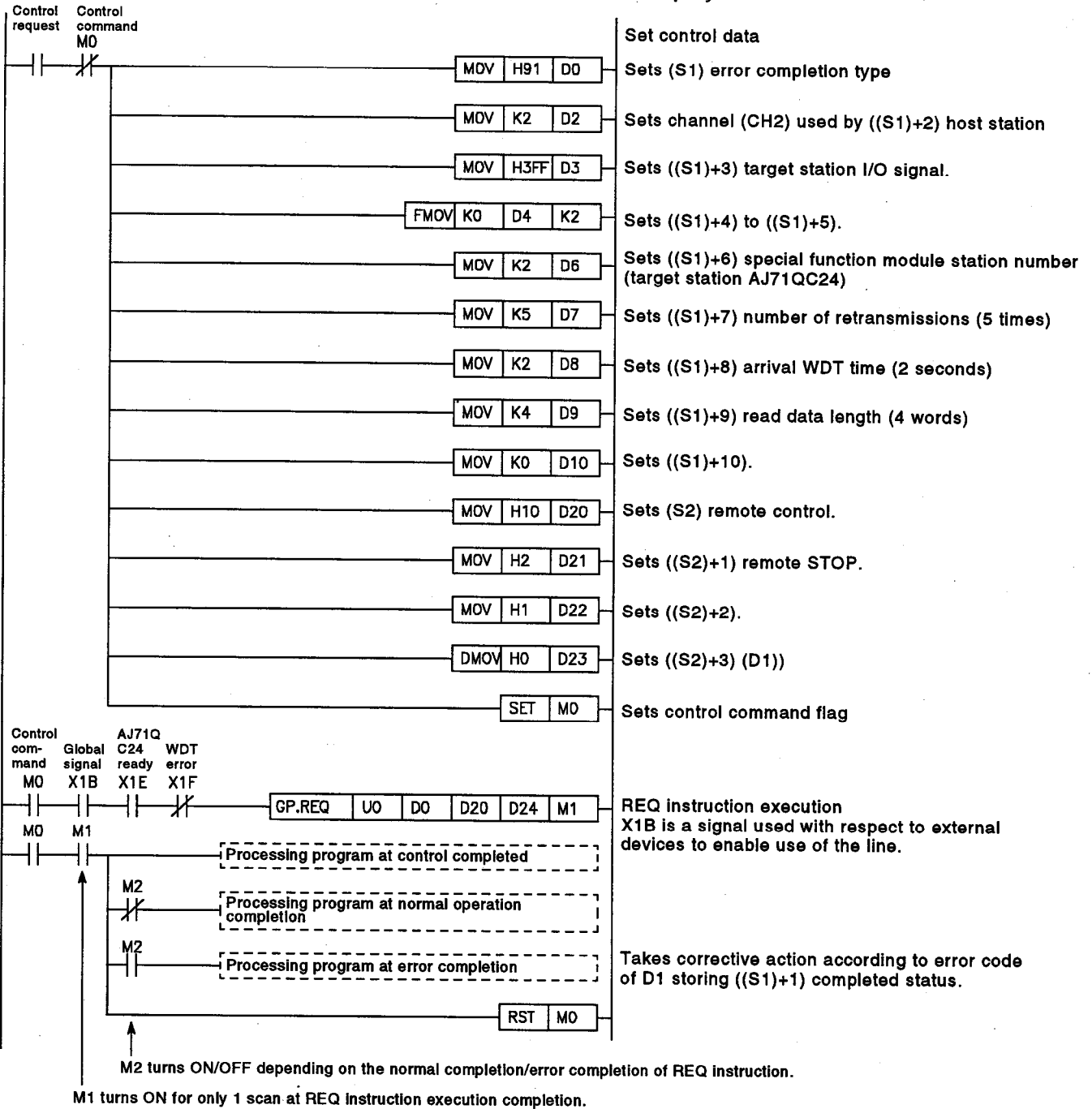

11. ID INTERFACE MODULE INSTRUCTIONS

ID interface module instructions are instructions for reading/writing data to ID data carriers, through ID interface modules.

The following table shows ID interface module instructions

Category	Instruction Name	Description	Refer to
ID controller initial setting	IDINIT1 IDINIT2	Writes channel 1 or channel 2 control data to ID interface module buffer memory.	11.1
Reading from ID data carrier	IDRD1 IDRD2	Reads data from ID data carrier through channels 1 or 2.	11.2
Writing to ID data carrier	IDWD1 IDWD2	Writes data to ID data carrier through channels 1 or 2.	11.3
Continuous reading from ID data carrier	IDARD1 IDARD2	Reads data after the ID data carrier has entered the communication range with the ID reader/writer.	11.4
Continuous writing to ID data carrier	IDAWD1 IDAWD2	Writes data after the ID data carrier has entered the communication range with the ID reader/writer.	11.5
Data comparison with ID data carrier	IDCMP1 IDCNP2	Compares the data of the ID data carrier and of the device memory.	11.6
Batch writing of same data to ID data carrier	IDFILL1 IDFILL2	Batch writes the same data into a designated area of the ID data carrier.	11.7
Copying between ID data carriers	IDCOPY1 IDCOPY2	Copies data between 2 ID data carriers through channels 1 and 2.	11.8

POINT

- (1) See the following manual for details about the ID interface module ID reader/writer, and ID data carrier.
AJ71ID1-R4/AJ71ID2-R4 and A1SJ71ID2-R4/A1SJ71ID2-R4 ID Interface Module User's manuals IB-66595

11.1 ID Controller Initial Setting

Set Data	Usable Devices								
	Internal Device (System, User)		File Register	MELSECNET/10 Direct J-BUS		Special Function Module U32G00	Index Register Zn	Constant	Other
	Bit	Word		Bit	Word				
(S)	—	0							

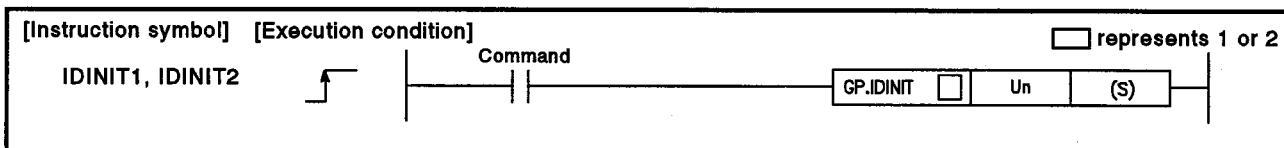

Set Data

Set Data	Description	Data Type
Un	Head I/O number of ID controller	16-bit binary
(S)	First device number of devices storing initial setting data designated in ID controller	Device name

Initial Set Data

Device	Description	Default Value	Setting Range
(S) + 0	<ul style="list-style-type: none"> Number of retries designation Sets the number of retries if communications between the ID data carrier and reader/writer could not be conducted normally. 	• 3	<ul style="list-style-type: none"> • 1 to 10 • 0 (no retries)
(S) + 1	<ul style="list-style-type: none"> Processing unit designation Sets whether the communication with the ID data carrier is conducted in word units or byte units. 	• 0 (word unit)	<ul style="list-style-type: none"> • 0 (word unit) • 1 (byte unit)

Function

- Writes initial set data of devices from that designated at (S) onwards to the ID interface module designated by the head I/O number.
- IDINIT1 instructions conduct initial settings for ID interface module channel 1, and IDINIT2 instructions for channel 2.
- Conduct the initial setting with these instructions after starting the system, and before executing the first ID interface module instructions. If other ID controller dedicated instructions have already been executed, the initial settings of these instructions are ignored.

Operation Errors

- (1) In the following cases an operation error occurs, the error flag (SM0) turns ON, and the error code is stored in SD0.
- When the module attempting access is not a special function module. (Error code: 2110)
 - When the ID interface module control instructions cannot be used with the designated module. (Error code: 2112)
 - When the designated instruction name is illegal. (Error code: 4300)
 - When the number of ID interface module instruction devices is illegal. (Error code: 4301)
 - When a non-designatable device is designated. (Error code: 4302)

POINT

- (1) The initial setting data content is not checked in IDINIT1 or IDINIT2 instructions.
If the initial setting data is outside the setting range, the ID interface module conducts control by using default values.

11.2 Reading from ID Data Carrier

Set Data	Usable Devices								
	Internal Device (System, User)		File Register	MELSECNET/10 Direct J-BUS		Special Function Module U-BUS	Index Register Zn	Constant K, H	Other
	Bit	Word		Bit	Word				
n1	○	○				—	○	—	
(D1)	—	○				—	—	—	
n2	○	○				—	○	—	
(D2)	○	○				—	—	—	

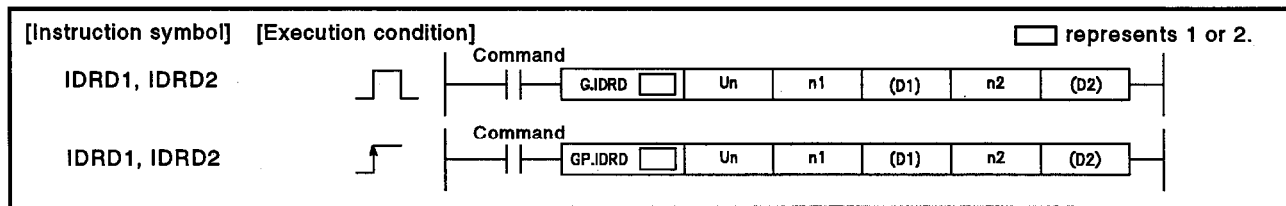

Set Data

Set Data	Description	Data Type
Un	Head I/O number of ID interface module	16-bit binary
n1	First address of ID data carrier	
(D1)	First number of device storing data to be read	Device name
n2	Number of read data (0 to 3900)	16-bit binary
(D2)	Number of the bit device turning ON after execution completed (at error completion (D2)+1 also turns ON)	Bit

Function

- (1) Reads the number of data designated at n2 from the address designated at ID data carrier n1 through the ID interface designated by the head I/O number, and stores data from the device designated at (D1) onwards.
- (2) After reading is completed, when the END instruction is executed for the scan completing the instruction, the bit device designated at (D2) is turned ON, and automatically turns OFF after one scan. At error completion, the completion status indication device ((D2)+1) also turns ON for one scan.
- (3) IDRD1 instructions are executed in ID interface module channel 1, and IDRD2 instructions in ID interface module channel 2.
- (4) There is no operation when the value designated at n2 is 0.
- (5) Error completion occurs when the address designated at n1, or the number of data designated at n2, exceeds the permissible range for the ID data carrier.

Operation Errors

- (1) In the following cases an operation error occurs, the error flag (SM0) turns ON, and the error code is stored in SD0.
 - When the number of points n2 from the device number designated at (D1) exceeds the applicable device. (Error code: 4101)
 - When the value designated at n2 is outside the range 0 to 3900. (Error code: 4100)
 - When the module attempting access is not a special function module. (Error code: 2110)
 - When the ID interface module control instructions cannot be used with the designated module. (Error code: 2112)
 - When the designated instruction name is illegal. (Error code: 4300)
 - When the number of ID interface module instruction devices is illegal. (Error code: 4301)
 - When a non-designatable device is designated. (Error code: 4302)

Program Example

- (1) A program which, when X0 turns ON, reads 5 words of data from ID data carrier address 100 through channel 1 of the ID interface module installed at I/O numbers X/Y60 to X/Y7F, and stores this data from D0 onwards, is shown here.

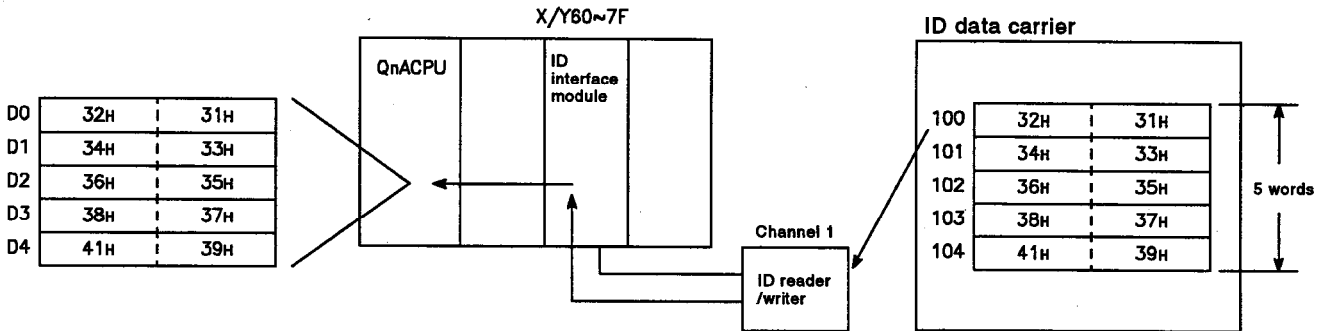

[Ladder mode]

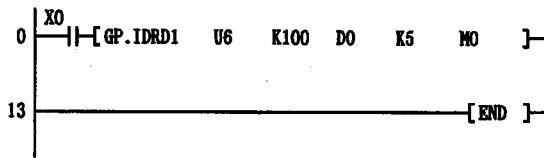

[List mode]

Step	Instruction	Device
0	LD	X0
1	GP.IDRD1	U6 K100 D0 K5 M0
13	END	

[Operation]

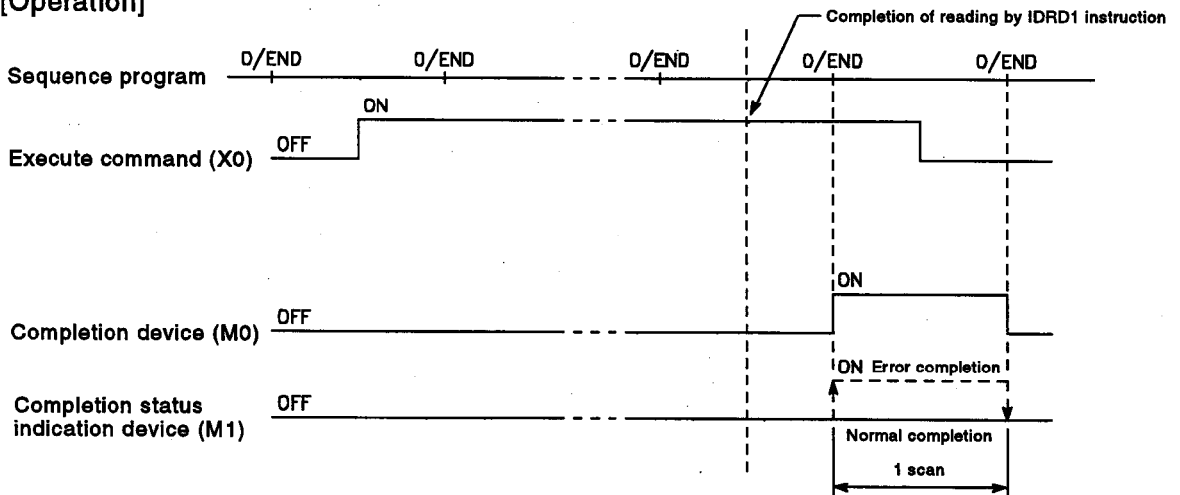

11.3 Writing to ID Data Carrier

Set Data	Usable Devices								
	Internal Device (System, User)		File Register	MELSECNET/10 Direct J-box		Special Function Module Usage	Index Register Zn	Constant K, H	Other
	Bit	Word		Bit	Word				
n1	○	○				—	○	—	
(S)	—	○				—	—	—	
n2	○	○				—	○	—	
(D)	○	—				—	—	—	

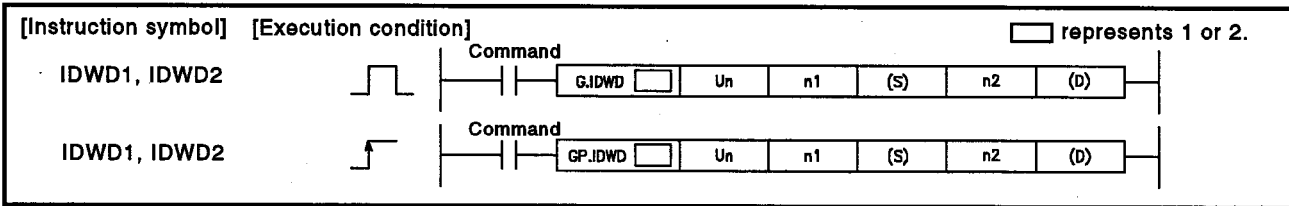

Set Data

Set Data	Description	Data Type
Un	Head I/O number of ID interface module	16-bit binary
n1	First address of ID data carrier	
(S)	First device number of devices storing write data	Device name
n2	Number of write data (0 to 3900)	16-bit binary
(D)	Number of bit device turning ON at execute completion (at error completion, (D)+1 also turns ON)	Bit

Function

- (1) Writes n2 points of data starting from the device designated at (S) to ID data carrier addresses starting at the one designated at n1, through the ID interface module designated by the head I/O number.
- (2) After writing is completed, at the END instruction execution of the scan completing the instruction, the bit device designated at (D) turns ON and automatically turns OFF after one scan.
At error completion, the completion status indication device ((D)+1) also turns ON for one scan.
- (3) IDWD1 instructions execute by ID interface module channel 1, and IDWD2 instructions by channel 2.
- (4) There is no operation when the value designated at n2 is 0.
- (5) Error completion occurs when the address designated at n1, or the number of data designated at n2 exceeds the permissible range for the ID data carrier.

Operation Errors

- (1) In the following cases an operation error occurs, the error flag (SM0) turns ON, and the error code is stored in SD0.
 - When the number of points n2 from the device number designated at (S) exceeds the applicable device. (Error code: 4101)
 - When the value designated at n2 is outside the range 0 to 3900. (Error code: 4100)
 - When the module attempting access is not a special function module. (Error code: 2110)
 - When the ID interface module control instructions cannot be used with the designated module. (Error code: 2112)
 - When the designated instruction name is illegal. (Error code: 4300)
 - When the number of ID interface module instruction devices is illegal. (Error code: 4301)
 - When a non-designatable device is designated. (Error code: 4302)

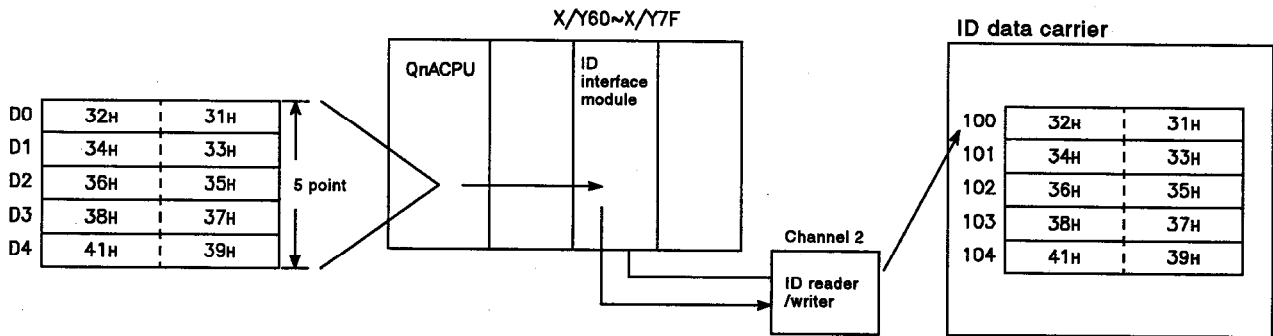

Program Example

- (1) A program which, when X0 turns ON, writes the data stored in D0 to D4 to 5 words from ID data carrier address 100, through channel 2 of the ID interface module installed at I/O numbers X/Y60 to X/Y7F.

[Ladder mode]

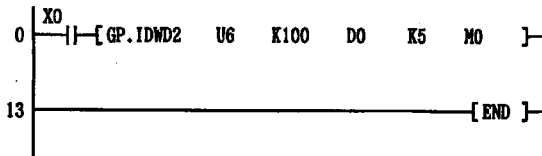

[List mode]

Step	Instruction	Device
0	LD	X0
1	GP.IDWD2	U6 K100 D0 K5 M0
13	END	

[Operation]

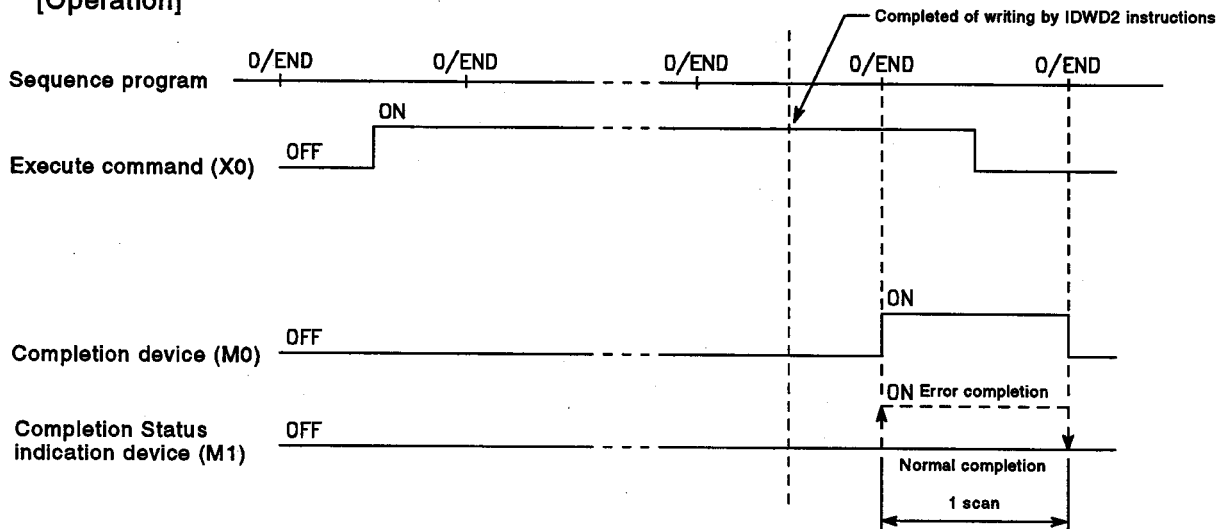

11.4 Continuous Reading from ID Data Carrier

Set Data	Usable Devices								
	Internal Device (System, User)		File Register	MELSECNET/10 Direct JCS/CS		Special Function Module UCS/GCS	Index Register Zn	Constant K, H	Other
	Bit	Word		Bit	Word				
n1	○	○				○		—	
(D1)	—	○				—		—	
n2	○	○				○		—	
(D2)	○	—				—		—	

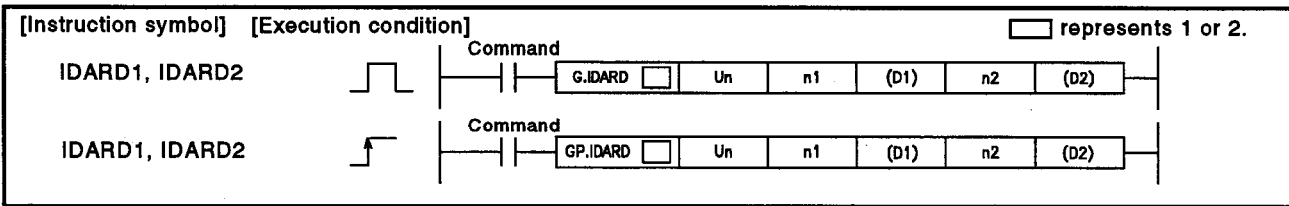

Set Data

Set Data	Description	Data Type
Un	Head I/O number of ID interface module	16-bit binary
n1	First address of ID data carrier	
(D1)	First number of device storing data to be read	Device name
n2	Number of read data (0 to 3900)	16-bit binary
(D2)	Number of the bit device turning ON after execution completed (at error completion (D2)+1 also turns ON)	Bit

Function

- (1) Reads the number of data designated at n2 from the ID data carrier addresses starting at the one designated by n1, through the ID interface designated by the head I/O number, and stores this data at devices starting from that designated at (D1).
- (2) When the ID data carrier is not within the range of communication with the ID reader/writer, the system waits for the ID data carrier to enter the communication range, and then reads data from it.
- (3) When continuous reading is completed, at the END instruction execution of the scan completing instruction, the bit device designated at (D2) turns ON and automatically turns OFF after one scan. At error completion, the completion status indication device ((D2)+1) also turns ON for one scan.
- (4) IDRD1 instructions execute by ID interface module channel 1, and IDRD2 instructions by channel 2.
- (5) There is no operation when the value designated at n2 is 0.
- (6) Error completion occurs when the address designated at n1, or the number of data designated at n2 exceeds the permissible range for the ID data carrier.

Operation Errors

- (1) In the following cases an operation error occurs, the error flag (SM0) turns ON, and the error code is stored in SD0.
 - When the number of points n2 from the device number designated at (D1) exceeds the applicable device. (Error code: 4100)
 - When the value designated at n2 is outside the range 0 to 3900. (Error code: 4100)
 - When the module attempting access is not a special function module. (Error code: 2110)
 - When the ID interface module control instructions cannot be used with the designated module. (Error code: 2112)
 - When the designated instruction name is illegal. (Error code: 4300)
 - When the number of ID interface module instruction devices is illegal. (Error code: 4301)
 - When a non-designatable device is designated. (Error code: 4302)

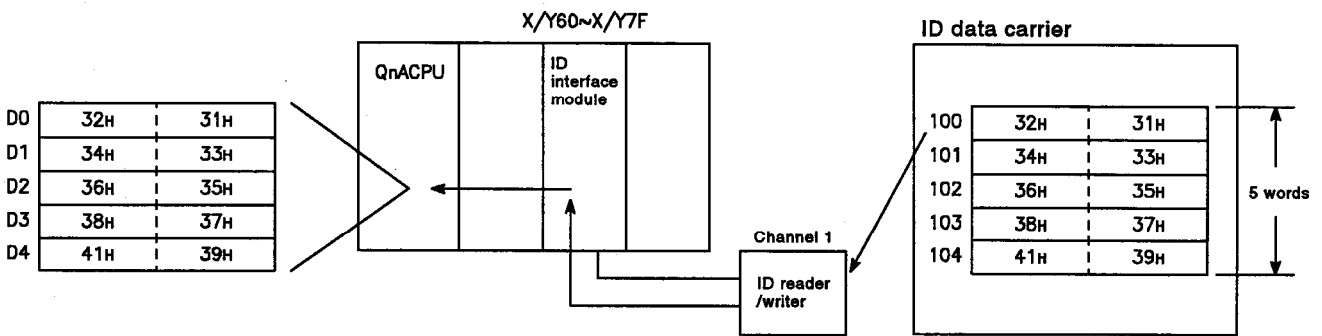

Program Example

- (1) A program which, when X0 turns ON, waits for the ID data carrier to enter the communication range, reads 5 words of data from ID data carrier address 100, and stores the data from D0 onwards, is shown here.

[Ladder mode]

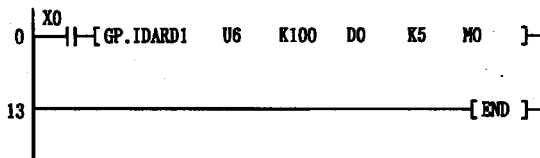

[List mode]

Step	Instruction	Device
0	LD	X0
1	GP.IDARD1	U6 K100 D0 K5 M0
13	END	

[Operation]

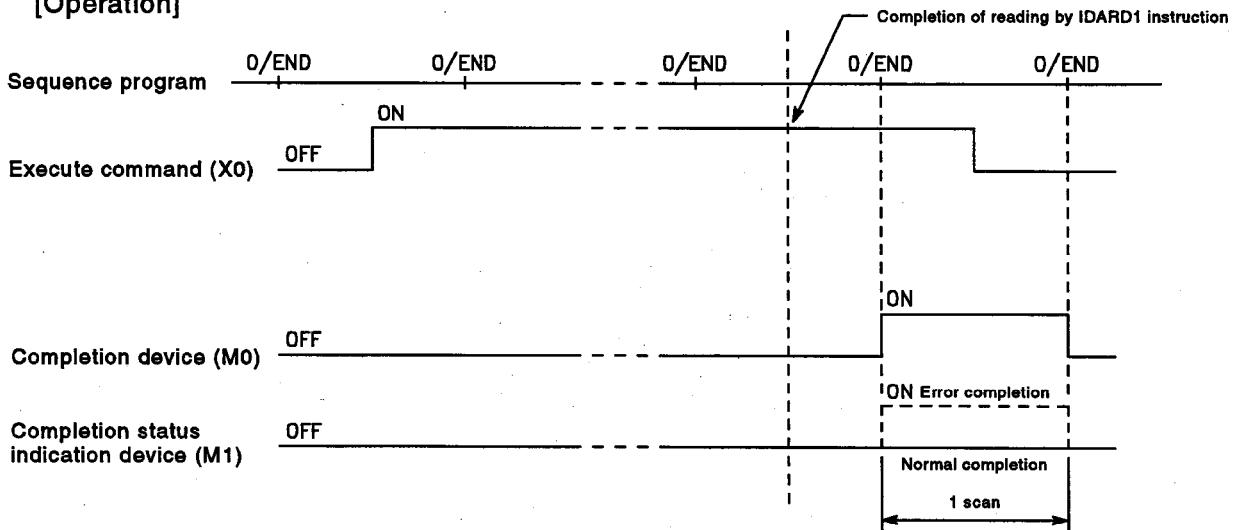

11.5 Continuous Writing to ID Data Carrier

Set Data	Usable Devices								
	Internal Device (System, User)		File Register	MELSECNET/10 Direct J-BUS		Special Function Module U-DAWG	Index Register Zn	Constant K, H	Other
	Bit	Word		Bit	Word				
n1	○	○				○		—	
(S)	—	○				—		—	
n2	○	○				○		—	
(D)	○	—				—		—	

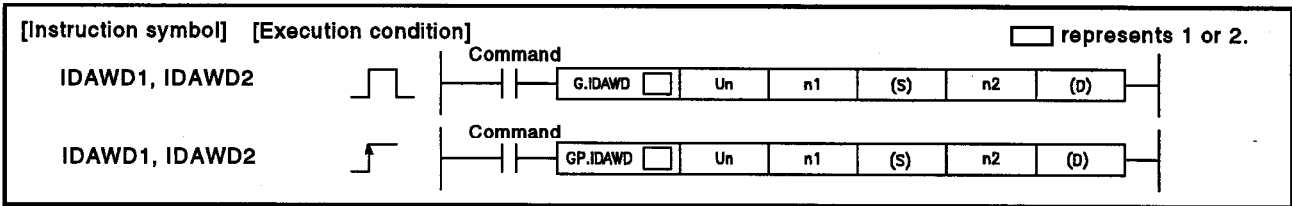

Set Data

Set Data	Description	Data Type
Un	Head I/O number of ID controller	16-bit binary
n1	First address of ID data carrier	
(D1)	First device number of devices storing write data	Device name
n2	Number of write data (0 to 3900)	16-bit binary
(D2)	Number of bit device turning ON at execution completion (at error completion, (D)+1 also turns ON)	Bit

Function

- (1) Writes n2 points of data from the device designated at (S) to the ID data carrier address designated at n1 onwards, through the ID interface module designated by the head I/O number.
- (2) When the ID data carrier is not in the range of communication with the ID reader/writer, the system waits for the ID data carrier to enter the range of communication, and then writes data to it.
- (3) When continuous writing is completed, at the END instruction execution of the scan completing the instruction, the bit device designated at (D) turns ON and automatically turns OFF after one scan. At error completion, the completion status indication device ((D)+1) also turns ON for one scan.
- (4) IDAWD1 instructions are executed with respect to ID interface module channel 1, and IDAWD2 instructions with respect to channel 2.
- (5) There is no operation when the value designated at n2 is 0.
- (6) Error completion occurs when the address designated at n1, or the number of data designated at n2 exceeds the permissible range for the ID data carrier.

Operation Errors

- (1) In the following cases an operation error occurs, the error flag (SM0) turns ON, and the error code is stored in SD0.
 - When the number of points n2 from the device number designated at (S) exceeds the applicable device. (Error code: 4101)
 - When the value designated at n2 is outside the range 0 to 3900. (Error code: 4100)
 - When the module attempting access is not a special function module. (Error code: 2110)
 - When the ID interface module control instructions cannot be used with the designated module. (Error code: 2112)
 - When the designated instruction name is illegal. (Error code: 4300)
 - When the number of ID interface module instruction devices is illegal. (Error code: 4301)
 - When a non-designatable device is designated. (Error code: 4302)

Program Example

- (1) A program which, when X0 turns ON, waits for the ID data carrier to enter the communication range, reads 5 words of data from ID data carrier address 100, and stores the data from D0 onwards, is shown here.

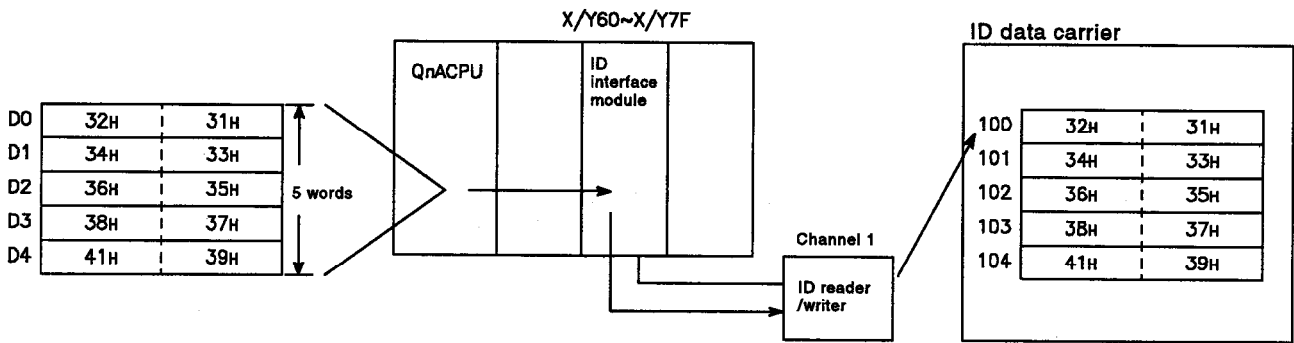

[Ladder mode]

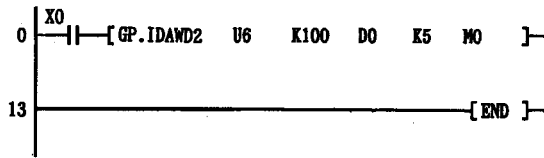

[List mode]

Step	Instruction	Device
0	LD	X0
1	GP.IDAWD2	U6 K100 D0 K5 M0
13	END	

[Operation]

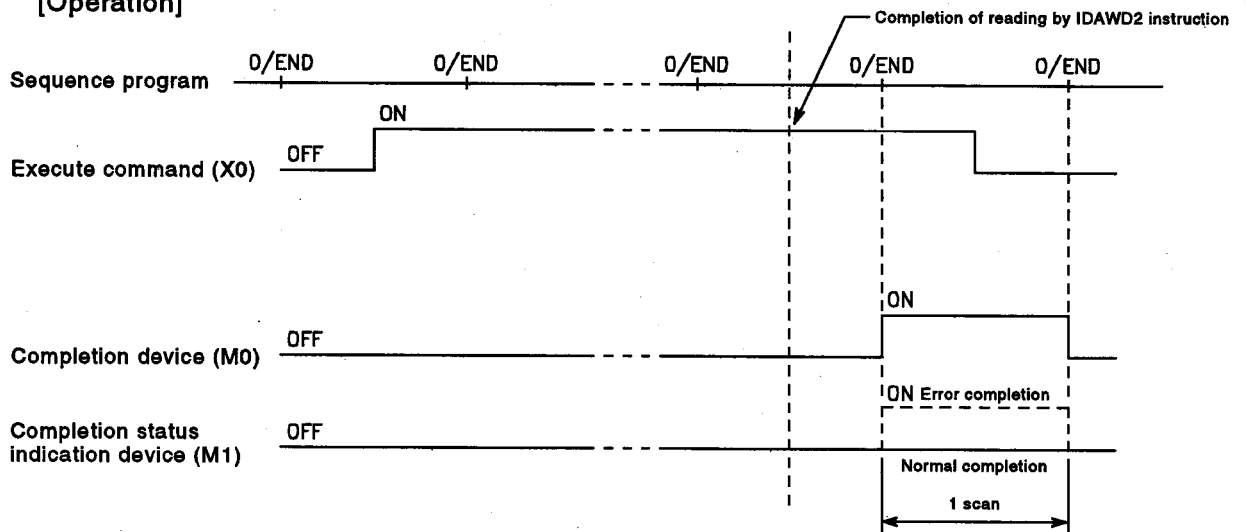

11.6 Data Comparison with ID Data Carrier

Set Data	Usable Devices								
	Internal Device (System, User)		File Register	MELSECNET/10 Direct J-BUS		Special Function Module (SFM)	Index Register Zn	Constant K, H	Other
	Bit	Word		Bit	Word				
n1	○	○			○			—	
(S)	—	○			—			—	
n2	○	○			○			—	
(D)	○	—			—			—	

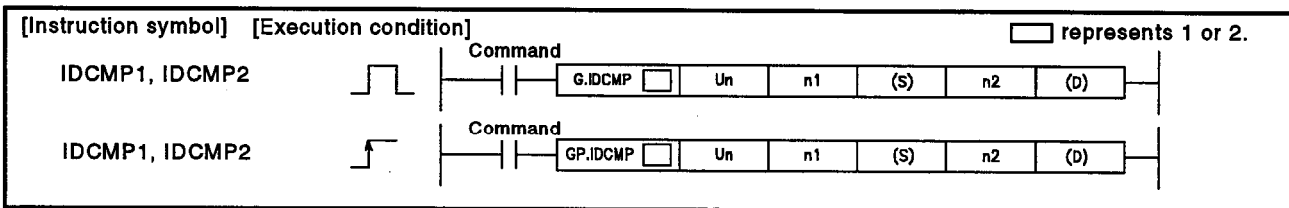

Set Data

Set Data	Description	Data Type
Un	Head I/O number of ID controller	16-bit binary
n1	First address of ID data carrier	
(D1)	First device number of devices storing comparison data	Device name
n2	Number of comparison data (0 to 3900)	16-bit binary
(D2)	Number of bit device turning ON at execution completion (at error completion, (D)+1 also turns ON)	Bit

Function

- (1) Writes n2 points of data from the device designated at (S) to the ID data carrier address designated at n1, through the ID interface module designated by the head I/O number.
- (2) Error completion occurs if the result of the comparison shows inconsistent data.
- (3) When data comparison is completed, at the END instruction execution of the scan completing the instruction, the bit device designated at (D) turns ON and automatically turns OFF after one scan. At error completion, the completion status indication device ((D)+1) also turns ON for one scan.
- (4) IDCMP1 instructions are executed with respect to ID interface module channel 1, and IDCMP2 instructions with respect to channel 2.
- (5) There is no operation when the value designated at n2 is "0".
- (6) Error completion occurs when the address designated at n1, or the number of data designated at n2, exceeds the permissible range for the ID data carrier.

Operation Errors

- (1) In the following cases an operation error occurs, the error flag (SM0) turns ON, and the error code is stored in SD0.
 - When the range designated at S2 exceeds the applicable device range of the device designated at (S). (Error code: 4101)
 - When the value designated at n2 is outside the range 0 to 3900. (Error code: 4100)
 - When the module attempting access is not a special function module. (Error code: 2110)
 - When the ID interface module control instructions cannot be used with the designated module. (Error code: 2112)
 - When the designated instruction name is illegal. (Error code: 4300)
 - When the number of ID interface module instruction devices is illegal. (error code: 4301)
 - When a non-designatable device is designated. (Error code: 4302)

Program Example

- (1) A program which, when X0 is ON, compares 5 word data from ID data carrier address 100 through channel 2 of the ID interface module installed in I/O number X/Y60 to X/Y7F, with word (point) data from D0.

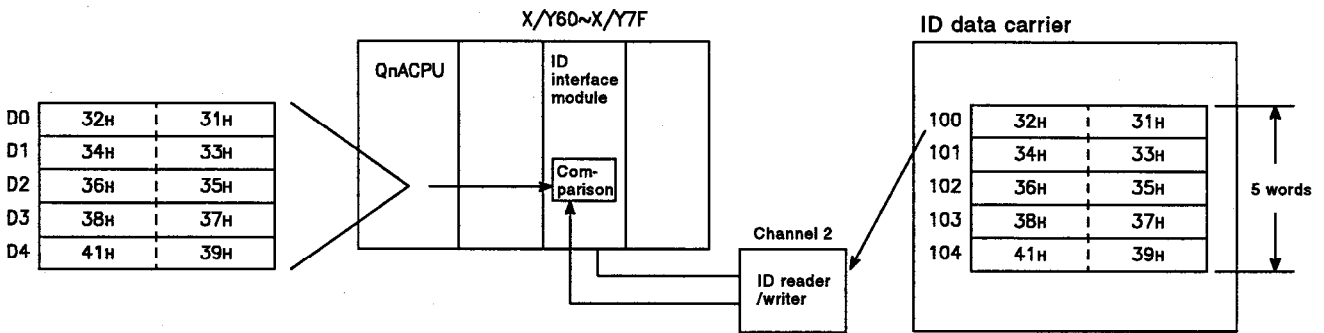

[Ladder mode]

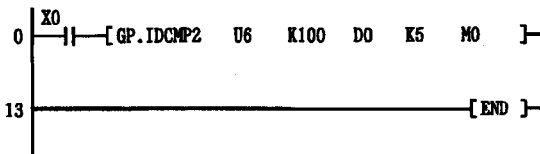

[List mode]

Step	Instruction	Device
0	LD	X0
1	GP.IDCMP2	U6 K100 D0 K5 M0
13	END	

[Operation]

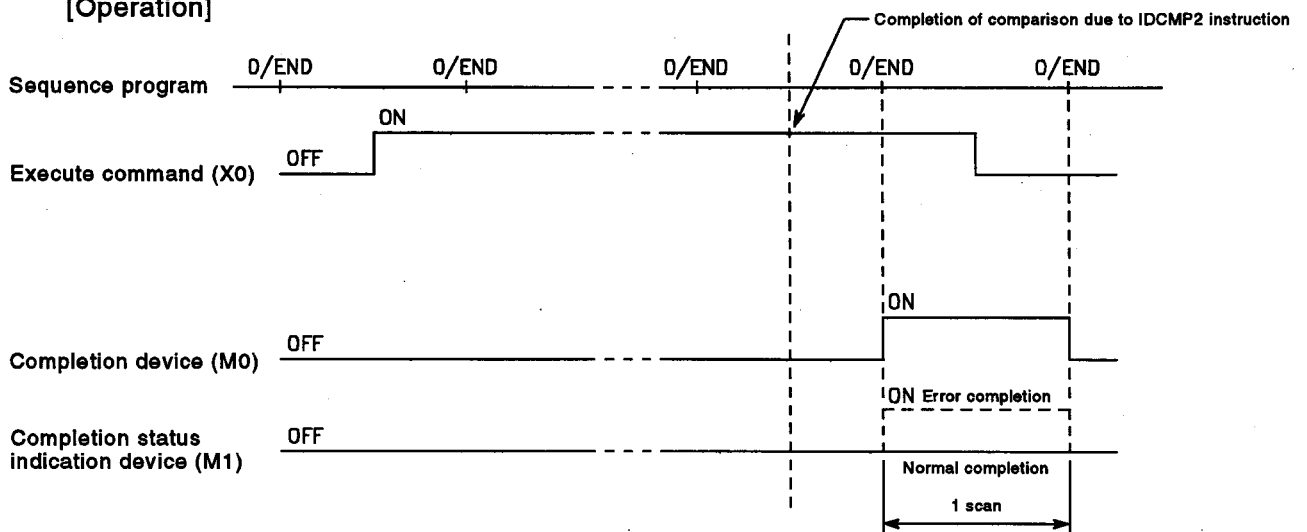

11.7 Batch Writing Same Data to ID Data Carrier

Set Data	Usable Devices								
	Internal Device (System, User)		File Register	MELSECNET/10 Direct J-BUS		Special Function Module U-BUS	Index Register Zn	Constant K, H	Other
	Bit	Word		Bit	Word				
n1	○				○				—
(S)	○				○				—
n2	○				○				—
(D)	○				—				—

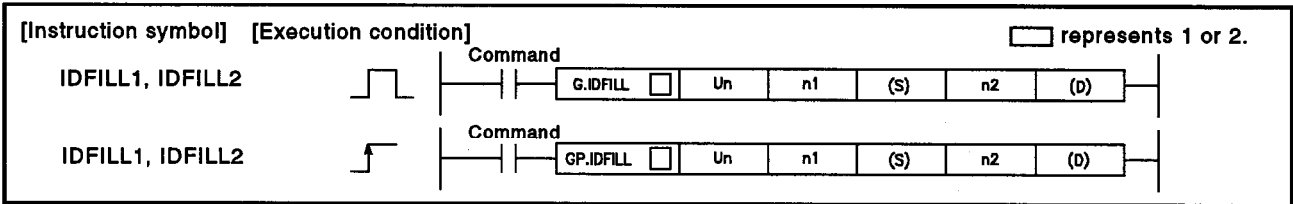

Set Data

Set Data	Description	Data Type
Un	Head I/O number of ID controller	16-bit binary
n1	First address of ID data carrier	
(S)	Write data or first device number of devices storing write data	
n2	Number of write data (0 to 3900)	
(D)	Number of bit device turning ON at execute completion (at error completion, (D)+1 also turns ON)	Bit

Function

- (1) Writes data designated at (S) from ID data carrier address designated at n1 to an area of the number of data designated at n2, through the ID interface module designated by the head I/O number.
- (2) When batch writing of same data is completed, at the END instruction execution of the scan completing instruction, the bit device designated at (D) turns ON and automatically turns OFF after the next scan. At error completion, the completion status indication device ((D)+1) also turns ON for one scan.
- (3) IDFILL1 instructions are executed with respect to ID interface module channel 1, and IDFILL2 instructions with respect to channel 2.
- (4) There is no operation when the value designated at n2 is "0".
- (5) Error completion occurs when the address designated at n1, or the number of data designated at n2, exceeds the permissible range for the ID data carrier.

Operation Errors

- (1) In the following cases an operation error occurs, the error flag (SM0) turns ON, and the error code is stored in SD0.
 - When the value designated at n2 is outside the range 0 to 3900. (Error code: 4100)
 - When the module attempting access is not a special function module. (Error code: 2110)
 - When the ID interface module control instructions cannot be used with the designated module. (Error code: 2112)
 - When the designated instruction name is illegal. (Error code: 4300)
 - When the number of ID interface module instruction devices is illegal. (Error code: 4301)
 - When a non-designatable device is designated. (Error code: 4302)

Program Example

- (1) A program which, when X0 is ON, batch writes 5 words of data from ID data carrier address 100, through channel 2 of the ID interface module installed at I/O numbers X/Y60 to X/Y7F, is shown here.

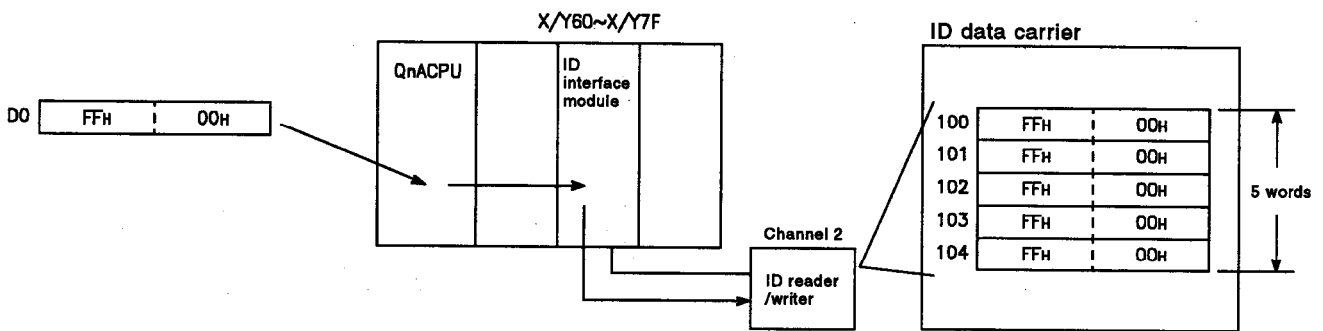

[Ladder mode]

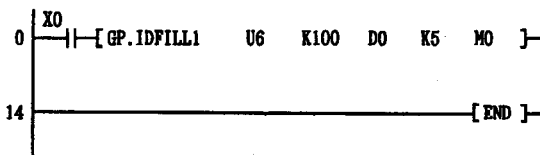

[List mode]

Step	Instruction	Device
0	LD	X0
1	GP.IDFILL1	U6 K100 D0 K5 M0
14	END	

[Operation]

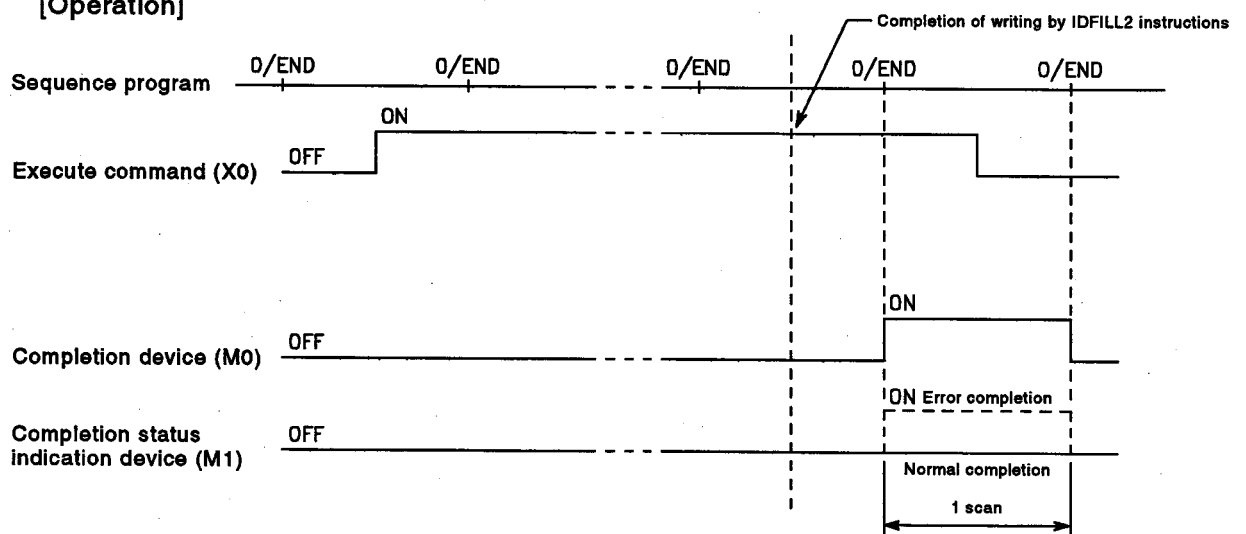

11.8 Copying between ID Data Carriers

Set Data	Usable Devices								
	Internal Device (System, User)		File Register	MELSECNET/10 Direct J-BUS		Special Function Module U-BUS	Index Register Zn	Constant K, H	Other
	Bit	Word		Bit	Word				
n1	○						○	—	
n2	○						○	—	
n3	○						○	—	
(D)	○						—	—	

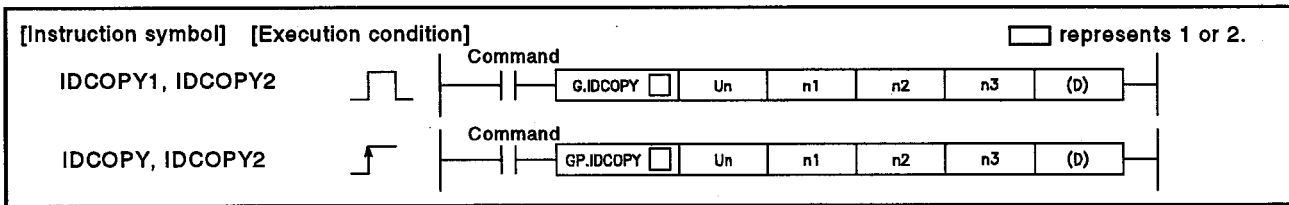

Set Data

Set Data	Description	Data Type
Un	Head I/O number of ID interface module	16-bit binary
n1	First address of copy source ID data carrier	
n2	First address of copy destination data carrier	
n3	Number of data copied (0 to 3900)	
(D)	Number of bit device turning ON at execute completion (at error completion, (D)+1 also turns ON)	Bit

Function

- (1) Copies the number of data designated at n2 from the copy source ID data carrier address designated at n1, to the copy destination ID data carrier address designated at n2, through the ID interface module designated by the head I/O number.
- (2) When copying between ID data carriers is completed, at the END instruction execution of the scan completing the instruction, the bit device designated at (D) turns ON and automatically turns OFF after one scan. At error completion, the completion status indication device ((D)+1) also turns ON for 1 scan.
- (3) The IDCOPY1 instruction copies from ID interface module channel 1 to channel 2, and the IDCOPY2 instruction copies from channel 2 to channel 1.
- (4) There is no operation when the value designated at n2 is "0".
- (5) Error completion occurs when the addresses designated at n1 and n2, or the number of data designated at n3, exceeds the permissible designation range for the ID data carrier.
- (6) Because these instructions use both channels 1 and 2, error completion occurs when there is only 1 channel.

Operation Errors

- (1) In the following cases an operation error occurs, the error flag (SM0) turns ON, and the error code is stored in SD0.
 - When the value designated at n2 is outside the range 0 to 3900. (Error code: 4100)
 - When the module attempting access is not a special function module. (Error code: 2110)
 - When the ID interface module control instructions cannot be used with the designated module. (Error code: 2112)
 - When the designated instruction name is illegal. (Error code: 4300)
 - When the number of ID interface module instruction device is illegal. (error code: 4301)
 - When a non-designatable device is designated. (Error code: 4302)

Program Example

- (1) A program which, when X0 is ON, copies 5 words of data from channel 1 ID data carrier address 100 to channel 2 ID data carrier addresses 200 to 204, through an ID interface module installed at I/O numbers X/Y60 to X/Y7F, is shown here.

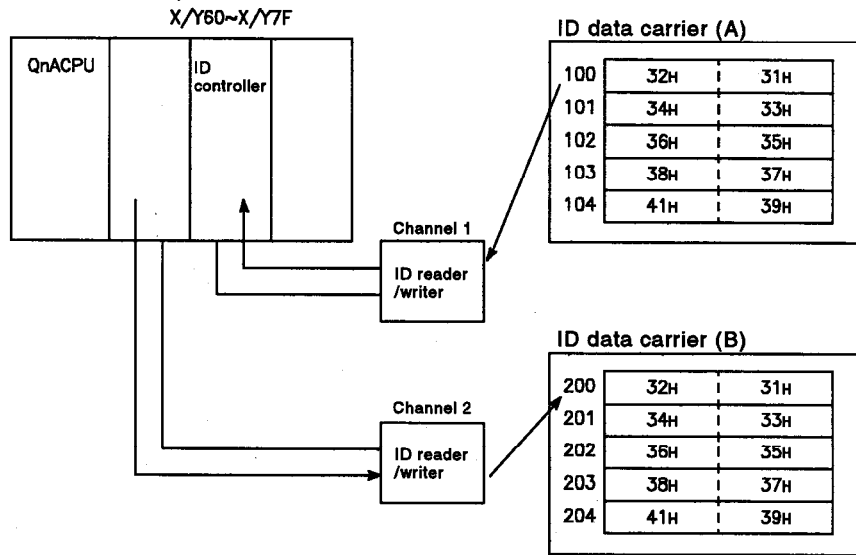

[Ladder mode]

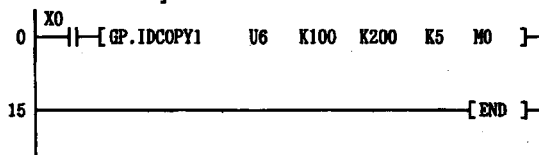

[List mode]

Step	Instruction	Device
0	LD	X0
1	GP.IDCOPY1	U6 K100 K200 K5 M0
15	END	

[Operation]

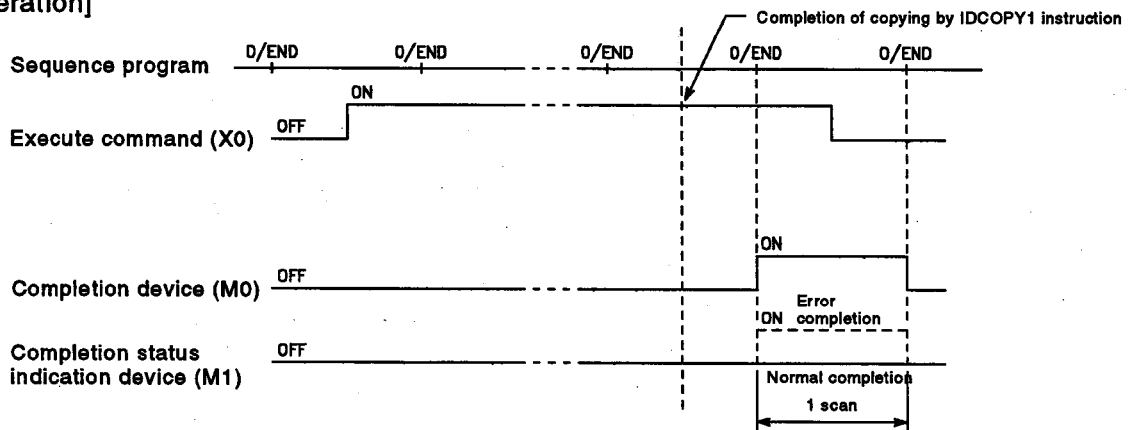

APPENDIX

APPENDIX 1 LIST OF PROCESSING TIMES

(1) AD61(S1) control instructions

Instruction	Condition	Q2A(S1)	Q3A	Q4A
PVWR1		226	170	85
PVWR2		226	170	85
SVWR1		245	184	92
SVWR2		247	186	93
PVRD1		245	184	92
PVRD2		245	184	92

(2) AD59(S1) control instructions

Instruction	Condition	Q2A(S1)	Q3A	Q4A
PRN	2 characters	136	102	51
	96 characters	136	102	51
PR	2 characters	128	96	48
	96 characters	128	96	48
GET	1 word	277	208	104
	96 words	790	594	297
PUT	1 word	277	208	104
	96 words	790	594	297

(3) AJ71PT32-S3 control instructions

Instruction	Condition	Q2A(S1)	Q3A	Q4A
INPUT		165	124	62
PRN	1 character	144	108	54
	96 characters	144	108	54
PR	1 character	136	102	51
	96 characters	136	102	51
GET	FROM 1 time	128	96	48
	FROM 16 times	1,319	992	496
MINIERR		48	36	18

(4) AJ71C21(S1) control instructions

Instruction	Condition	Q2A(S1)	Q3A	Q4A
PRN2,PRN4	2 characters	136	102	51
	96 characters	136	102	51
PR2,PR4	2 characters	125	94	47
	96 characters	125	94	47
INPUT2,INPUT4		138	104	52
GET	1 word	141	106	53
	96 words	141	106	53
PUT	1 word	144	108	54
	96 words	144	108	54

(5) Computer link module control instructions

Instruction	Condition	Q2A(S1)	Q3A	Q4A
PRN	2 characters	138	104	52
	96 characters	138	104	52
PR	2 characters	128	96	48
	96 characters	128	96	48
INPUT		141	106	53

IMPORTANT

Design the configuration of a system to provide an external protective or safety inter locking circuit for the PCs.

Under no circumstances will Mitsubishi Electric be liable or responsible for any consequential damage that may arise as a result of the installation or use of this equipment.

All examples and diagrams shown in this manual are intended only as an aid to understanding the text, not to guarantee operation. Mitsubishi Electric will accept no responsibility for actual use of the product based on these illustrative examples.

Owing to the very great variety in possible applications of this equipment, you must satisfy yourself as to its suitability for your specific application.

QnACPU PROGRAMMING MANUAL (Special Function module)

MODEL	QNA-P(TOKUSYU)-E
MODEL CODE	13JF48
IB(NA)66616-A(9606)MEE	



HEAD OFFICE : MITSUBISHI DENKI BLDG MARUNOUCHI TOKYO 100-0005 TELEX : J24532 CABLE MELCO TOKYO
NAGOYA WORKS : 1-14, YADA-MINAMI 5, HIGASHI-KU, NAGOYA, JAPAN

When exported from Japan, this manual does not require application to the Ministry of International Trade and Industry for service transaction permission.

Specifications subject to change without notice.

HEADQUARTERS

MITSUBISHI ELECTRIC EUROPE B.V. **EUROPE**
 German Branch
 Gothaer Straße 8
D-40880 Ratingen
 Phone: +49 (0)2102 / 486-0
 Fax: +49 (0)2102 / 486-1120

MITSUBISHI ELECTRIC EUROPE B.V.-org.sl. **CZECH REP.**
 Czech Branch
 Avenir Business Park, Radlická 714/113a
CZ-158 00 Praha 5
 Phone: +420 - 251 551 470
 Fax: +420 - 251-551-471

MITSUBISHI ELECTRIC EUROPE B.V. **FRANCE**
 French Branch
 25, Boulevard des Bouvets
F-92741 Nanterre Cedex
 Phone: +33 (0)1 / 55 68 55 68
 Fax: +33 (0)1 / 55 68 57 57

MITSUBISHI ELECTRIC EUROPE B.V. **IRELAND**
 Irish Branch
 Westgate Business Park, Ballymount
IRL-Dublin 24
 Phone: +353 (0)1 4198800
 Fax: +353 (0)1 4198890

MITSUBISHI ELECTRIC EUROPE B.V. **ITALY**
 Italian Branch
 Viale Colleoni 7
I-20041 Agrate Brianza (MB)
 Phone: +39 039 / 60 53 1
 Fax: +39 039 / 60 53 312

MITSUBISHI ELECTRIC EUROPE B.V. **POLAND**
 Poland Branch
 Krakowska 50
PL-32-083 Balice
 Phone: +48 (0)12 / 630 47 00
 Fax: +48 (0)12 / 630 47 01

MITSUBISHI ELECTRIC EUROPE B.V. **RUSSIA**
 52, bid. 3 Kosmodamianskaya nab 8 floor
RU-115054 Moscow
 Phone: +7 495 721-2070
 Fax: +7 495 721-2071

MITSUBISHI ELECTRIC EUROPE B.V. **SPAIN**
 Spanish Branch
 Carretera de Rubí 76-80
E-08190 Sant Cugat del Vallés (Barcelona)
 Phone: 902 131121 // +34 935653131
 Fax: +34 935891579

MITSUBISHI ELECTRIC EUROPE B.V. **UK**
 UK Branch
 Travellers Lane
UK-Hatfield, Herts. AL10 8XB
 Phone: +44 (0)1707 / 27 61 00
 Fax: +44 (0)1707 / 27 86 95

MITSUBISHI ELECTRIC CORPORATION **JAPAN**
 Office Tower "Z" 14 F
 8-12,1 chome, Harumi Chuo-Ku
Tokyo 104-6212
 Phone: +81 3 622 160 60
 Fax: +81 3 622 160 75

MITSUBISHI ELECTRIC AUTOMATION, Inc. **USA**
 500 Corporate Woods Parkway
Vernon Hills, IL 60061
 Phone: +1 847 478 21 00
 Fax: +1 847 478 22 53

EUROPEAN REPRESENTATIVES

GEVA **AUSTRIA**
 Wiener Straße 89
AT-2500 Baden
 Phone: +43 (0)2252 / 85 55 20
 Fax: +43 (0)2252 / 488 60

TEHNIKON **BELARUS**
 Oktyabrskaya 16/5, Off. 703-711
BY-220030 Minsk
 Phone: +375 (0)17 / 210 46 26
 Fax: +375 (0)17 / 210 46 26

ESCO DRIVES & AUTOMATION **BELGIUM**
 Culliganlaan 3
BE-1831 Diegem
 Phone: +32 (0)2 / 717 64 30
 Fax: +32 (0)2 / 717 64 31

Koning & Hartman b.v. **BELGIUM**
 Woluwelaan 31
BE-1800 Vilvoorde
 Phone: +32 (0)2 / 257 02 40
 Fax: +32 (0)2 / 257 02 49

INEA BH d.o.o. **BOSNIA AND HERZEGOVINA**
 Aleja Lipa 56
BA-71000 Sarajevo
 Phone: +387 (0)33 / 921 164
 Fax: +387 (0)33 / 524 539

AKHNATON **BULGARIA**
 4 Andrej Ljapchev Blvd. Pb 21
BG-1756 Sofia
 Phone: +359 (0)2 / 817 6044
 Fax: +359 (0)2 / 97 44 06 1

INEA CR d.o.o. **CROATIA**
 Losinjska 4 a
HR-10000 Zagreb
 Phone: +385 (0)1 / 36 940 -01 / -02 / -03
 Fax: +385 (0)1 / 36 940 -03

AutoCont C.S. s.r.o. **CZECH REPUBLIC**
 Technologická 374/6
CZ-708 00 Ostrava-Pustkovce
 Phone: +420 595 691 150
 Fax: +420 595 691 199

Beijer Electronics A/S **DENMARK**
 Lykkegårdsvej 17
DK-4000 Roskilde
 Phone: +45 (0)46 / 75 76 66
 Fax: +45 (0)46 / 75 56 26

Beijer Electronics Eesti OÜ **ESTONIA**
 Pärnu mnt.160i
EE-11317 Tallinn
 Phone: +372 (0)6 / 51 81 40
 Fax: +372 (0)6 / 51 81 49

Beijer Electronics OY **FINLAND**
 Peltoie 37
FIN-28400 Ulvila
 Phone: +358 (0)207 / 463 540
 Fax: +358 (0)207 / 463 541

UTEKO **GREECE**
 5, Mavrogenous Str.
GR-18542 Piraeus
 Phone: +30 211 / 1206 900
 Fax: +30 211 / 1206 999

MELTRADE Kft. **HUNGARY**
 Fertő utca 14.
HU-1107 Budapest
 Phone: +36 (0)1 / 431-9726
 Fax: +36 (0)1 / 431-9727

Beijer Electronics SIA **LATVIA**
 Rītausmas iela 23
LV-1058 Rīga
 Phone: +371 (0)784 / 2280
 Fax: +371 (0)784 / 2281

Beijer Electronics UAB **LITHUANIA**
 Savanorių Pr. 187
LT-02300 Vilnius
 Phone: +370 (0)5 / 232 3101
 Fax: +370 (0)5 / 232 2980

EUROPEAN REPRESENTATIVES

ALFATRADE Ltd. **MALTA**
 99, Paola Hill
Malta- Paola PLA 1702
 Phone: +356 (0)21 / 697 816
 Fax: +356 (0)21 / 697 817

INTEHSIS srl **MOLDOVA**
 bld. Traian 23/1
MD-2060 Kishinev
 Phone: +373 (0)22 / 66 4242
 Fax: +373 (0)22 / 66 4280

HIFLEX AUTOM.TECHNIEK B.V. **NETHERLANDS**
 Wolweverstraat 22
NL-2984 CD Ridderkerk
 Phone: +31 (0)180 - 46 60 04
 Fax: +31 (0)180 - 44 23 55

Koning & Hartman b.v. **NETHERLANDS**
 Haarlerbergweg 21-23
NL-1101 CH Amsterdam
 Phone: +31 (0)20 / 587 76 00
 Fax: +31 (0)20 / 587 76 05

Beijer Electronics AS **NORWAY**
 Postboks 487
NO-3002 Drammen
 Phone: +47 (0)32 / 24 30 00
 Fax: +47 (0)32 / 84 85 77

Fonseca S.A. **PORTUGAL**
 R. João Francisco do Casal 87/89
PT - 3801-997 Aveiro, Esgueira
 Phone: +351 (0)234 / 303 900
 Fax: +351 (0)234 / 303 910

Sirius Trading & Services srl **ROMANIA**
 Aleea Lacul Morii Nr. 3
RO-060841 Bucuresti, Sector 6
 Phone: +40 (0)21 / 430 40 06
 Fax: +40 (0)21 / 430 40 02

Craft Con. & Engineering d.o.o. **SERBIA**
 Bulevar Svetog Cara Konstantina 80-86
SER-18106 Nis
 Phone: +381 (0)18 / 292-24-4/5
 Fax: +381 (0)18 / 292-24-4/5

INEA SR d.o.o. **SERBIA**
 Izletnicka 10
SER-113000 Smederevo
 Phone: +381 (0)26 / 617 163
 Fax: +381 (0)26 / 617 163

SIMAP s.r.o. **SLOVAKIA**
 Jána Derku 1671
SK-911 01 Trenčín
 Phone: +421 (0)32 743 04 72
 Fax: +421 (0)32 743 75 20

PROCONT, spol. s r.o. Prešov **SLOVAKIA**
 Kúpeľná 1/A
SK-080 01 Prešov
 Phone: +421 (0)51 7580 611
 Fax: +421 (0)51 7580 650

INEA d.o.o. **SLOVENIA**
 Stegne 11
SI-1000 Ljubljana
 Phone: +386 (0)1 / 513 8100
 Fax: +386 (0)1 / 513 8170

Beijer Electronics AB **SWEDEN**
 Box 426
SE-20124 Malmö
 Phone: +46 (0)40 / 35 86 00
 Fax: +46 (0)40 / 93 23 01

Omni Ray AG **SWITZERLAND**
 Im Schörlí 5
CH-8600 Dübendorf
 Phone: +41 (0)44 / 802 28 80
 Fax: +41 (0)44 / 802 28 28

GTS **TURKEY**
 Bayraktar Bulvarı Nutuk Sok. No:5
TR-34775 Yukarı Dudullu-Ümraniye-İSTANBUL
 Phone: +90 (0)216 526 39 90
 Fax: +90 (0)216 526 39 95

CSC Automation Ltd. **UKRAINE**
 4-B, M. Raskovoyi St.
UA-02660 Kiev
 Phone: +380 (0)44 / 494 33 55
 Fax: +380 (0)44 / 494-33-66

EURASIAN REPRESENTATIVES

Kazpromautomatiks Ltd. **KAZAKHSTAN**
 Mustafina Str. 7/2
KAZ-470046 Karaganda
 Phone: +7 7212 / 50 11 50
 Fax: +7 7212 / 50 11 50

MIDDLE EAST REPRESENTATIVES

ILAN & GAVISH Ltd. **ISRAEL**
 24 Shenkar St., Kiryat Arie
IL-49001 Petah-Tiqva
 Phone: +972 (0)3 / 922 18 24
 Fax: +972 (0)3 / 924 0761

TEXEL ELECTRONICS Ltd. **ISRAEL**
 2 Ha'umanut, P.O.B. 6272
IL-42160 Netanya
 Phone: +972 (0)9 / 863 39 80
 Fax: +972 (0)9 / 885 24 30

CEG INTERNATIONAL **LEBANON**
 Cebaco Center/Block A Autostrade DORA
Lebanon - Beirut
 Phone: +961 (0)1 / 240 430
 Fax: +961 (0)1 / 240 438

AFRICAN REPRESENTATIVE

CBI Ltd. **SOUTH AFRICA**
 Private Bag 2016
ZA-1600 Isando
 Phone: +27 (0)11 / 977 0770
 Fax: +27 (0)11 / 977 0761