



**MITSUBISHI**  
Programmable Controller

## USER'S MANUAL

### MELSECNET/MINI INTERFACE UNIT F-16NP-E/NT-E

- This manual provides technical information and guidance on the use of the MELSECNET/MINI INTERFACE UNIT type F-16NP-E/F-16NT-E.
- Users should ensure that the detail of this manual and also the user's manual for MELSECNET/MINI "Master" are studied and understood before attempting to install or use the units.
- Information concerning the programming of the system, using the programming unit is covered in separate manuals.

**MITSUBISHI ELECTRIC CORPORATION**

## CONTENTS

1. General description .....	1
2. Installation .....	3
3. Connection .....	5
4. Installation and wiring work (general) .....	8
5. Programming .....	10
6. Specifications and outside dimensions .....	16
7. Summary of setting .....	19

## PREFACE

It is requested to read through the user's manual for the MELSECNET/MINI "Master" prior to reading this manual. It is advised to read this manual together with the "Master" before using the equipment to fully understand the specifications of the MELSECNET/MINI and of this unit, so that these units can be used correctly.

It is also requested to deliver the manual to the end user.

The model types P-16NT/NP & F-16NT-E/NP-E differ only in power supply specification. Part names with the letter E uses 110~120/220~240 V supply while without, it uses 100~110/200~220 V supply.

Information in this manual applies to both types even though sometimes only F-16NT/NP is specified. However, there will be exceptions when power supply is related.

These products contain Strategic Products subject to COCOM regulations. They should not be exported without authorization from the appropriate governmental authorities.

MITSUBISHI ELECTRIC CORP.



# General description

The F-16NP/NT-E MELSECNET/MINI interface unit is installed additionally to the basic unit of F-, F<sub>1</sub>- or F<sub>2</sub>-Series programmable controller to create a link system with other F/F<sub>1</sub>/F<sub>2</sub> programmable controllers as local programmable controllers for the MELSECNET/MINI. The data reception/transmission from/to the master programmable controller A series is executed by transferring the data in 8 points to and 8 points from the local programmable controller (F/F<sub>1</sub>/F<sub>2</sub> programmable controller) to the master programmable controller (programmable controller-A). i.e. total 16 points.

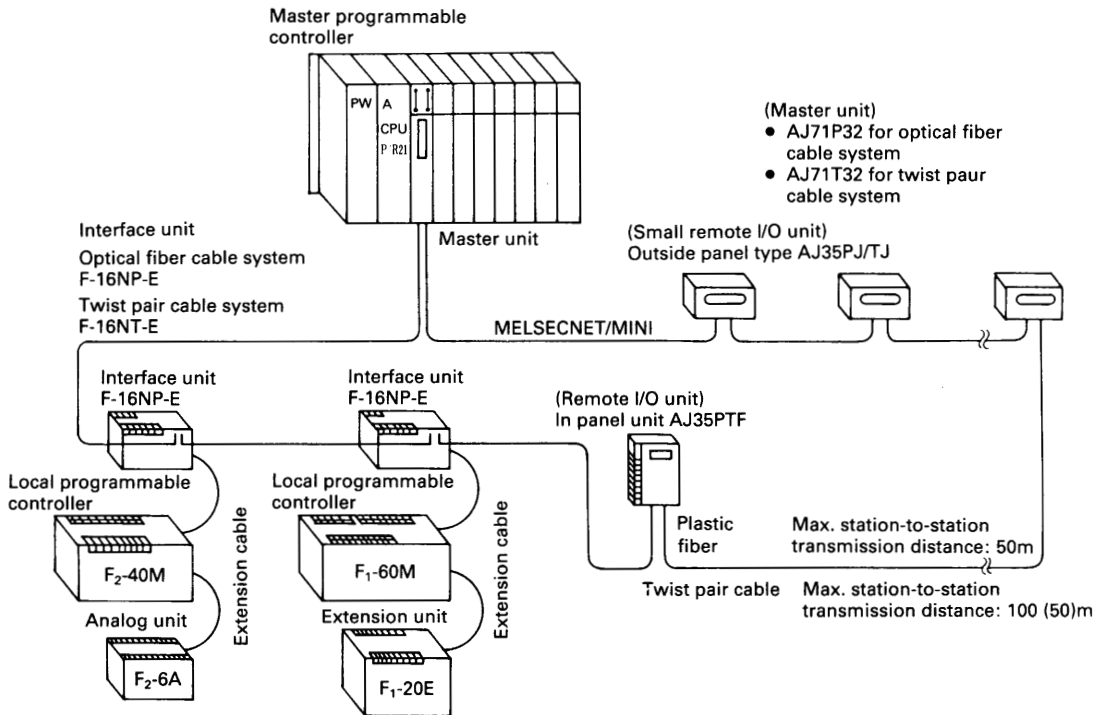

# EXTENSION CONFIGURATION

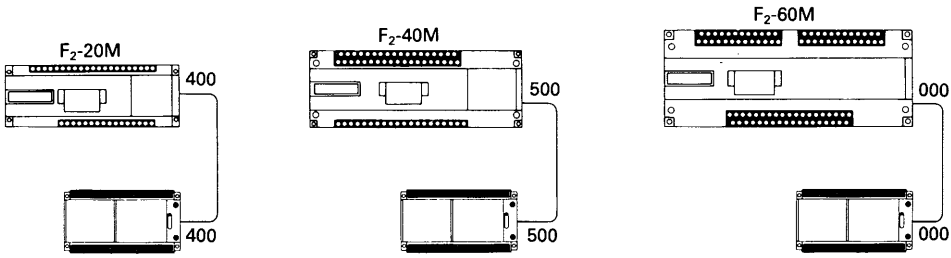

## List of unit names

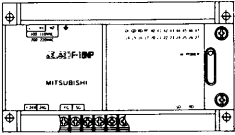
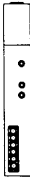
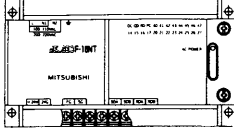
Optical fiber cable system		Twisted pair cable system	
Master station unit	Interface unit	Master station unit	Interface unit
 <p>AJ71P32</p>	 <p>F-16NP-E</p>	 <p>AJ71T32</p>	 <p>F-16NT-E</p>

## SETTING OF STATION CODE NO.

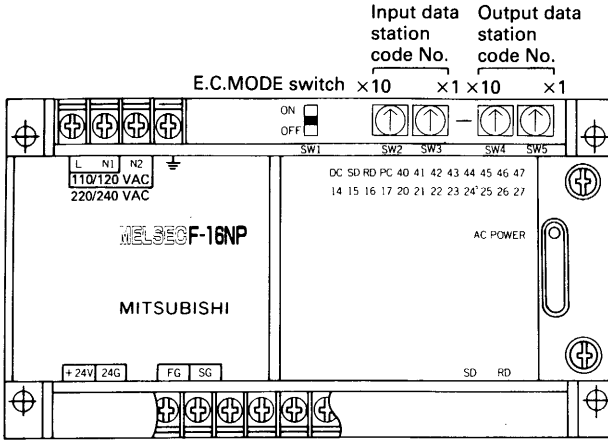

It is necessary to set two station code numbers for the F-16NP/NT-E; the station code number allotted to the 8-point input data transferred from the programmable controller-A to the programmable controller-F, and the station code number allotted to the 8-point output data transferred from the programmable controller-F to the programmable controller-A.

Set each of these station code number by using the 2-digit rotary switch.

Contents of station code number	Digit of 10 ( × 10 )	Digit of 1 ( × 1 )
Input data station code number (for 8-point data from A to F)	SW2	SW3
Output data station code number (for 8-point data from F to A)	SW4	SW5

Note-1: The setting range for station code number is from #01 to #64.

Note-2: Remember that duplicate settings (Same setting as another station) are not possible.

Remove the cover from the terminal block, and set the station code number.

After completion of the setting, re-attach the cover to the terminal block.

## E.C. MODE SETTING

When the E.C. mode is selected, it is possible to make the selection on whether the input data (sent from programmable controller-A to programmable controller-F) is held (HOLD) or reset (RESET) at the time when the master station of the MELSECNET/MINI interrupts the I/O refresh processing.

(i.e. at end of communication link, clear buffer or hold buffer.)

	RESET	HOLD
SW1	ON	OFF

When switch-1 is turned ON, all points of the input data are reset.

If it is turned OFF, the data at the time of I/O refresh operation interruption is held.

		E.C. MODE SWITCH	
		OFF	ON
MINI link communication start-up (Y18)	ON	Outputs the transmission data contents to the local programmable controller.	
	OFF	Holds the output condition right before MINI link communication start-up (Y18) is turned off.	Turns off all points of output.
Remote I/O communication failure		Holds the output condition right before communication failure.	Turns off all output points.

Note: The E.C. MODE switch has been set ON at the time of shipment.

## POINT

- It is not possible to set the station code number of the local programmable controller to the same station code number within the same loop.  
If the same station code number is set, the programmable controller may not operate properly.  
After setting the station code number, be sure to check that the setting station code number is not duplicated.
- If the station code number to be allotted to the input data and that to be allotted to the output data are set dividedly by consecutive number respectively, the transmission data and reception data can be accessed continuously by the master station, thus allowing efficient execution.  
If there are 10 local programmable controllers arranged, for instance, set the station code number at #1~#10 for the input data, and at #11~#20 for the output data.

## CONNECTION OF POWER AND EARTH (GROUND)

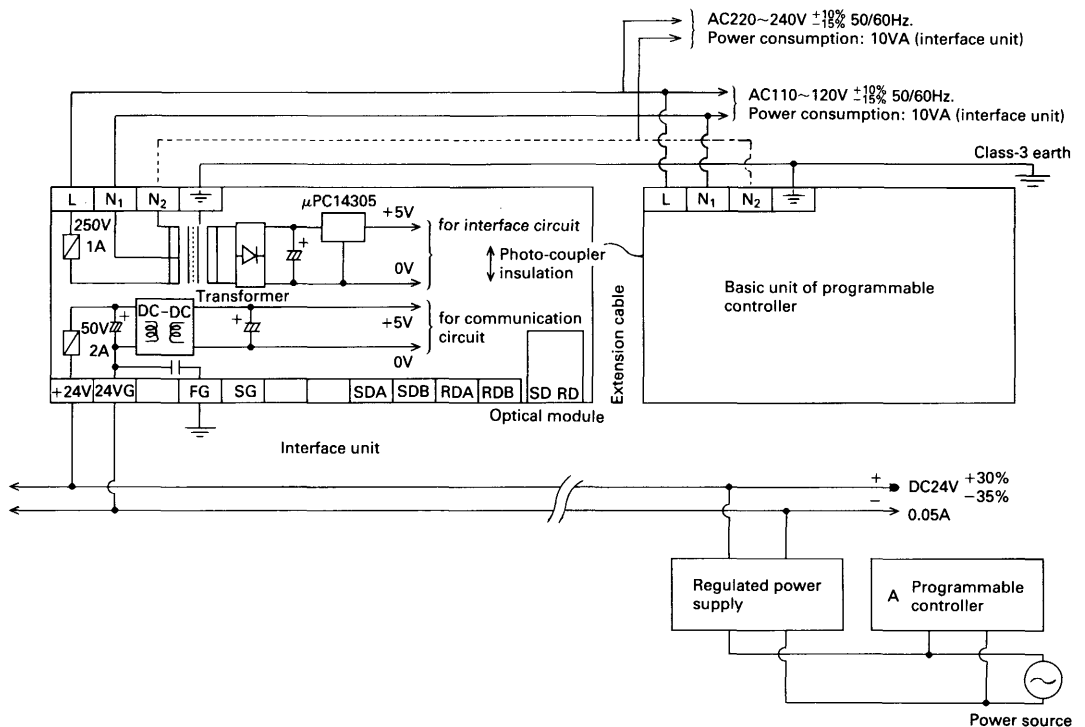

Connect the AC power source to the interface unit first.

For AC100V, connect to terminals L and N<sub>1</sub>.

For AC200V, connect to terminals L and N<sub>2</sub>.

In either case, execute the class-3 grounding for the AC power source.

The interface unit uses two +5V supplies. The +5V supply generated by the regulator  $\mu\text{PC14305}$  provides power to the F-PC interface circuits. Although the signal outputs of these circuits are opto-isolated, the power ground is connected directly via the extension cable to the ground of the F-base unit.

Connect the DC power supply to the interface unit (After connection of AC power).

Connect the 24V+ line of the external power supply to the +24V terminal, and the GND to 24VG terminal.

Connect the DC power supply from the 24V regulator which with the master programmable controller, share the same AC power source.

Execute the class-3 earth for the FG.

The interface unit internally isolates by the photo-coupler the 5V power source for the interface circuit and 5V power source for the communication circuit.

## PRECAUTIONS ON CONNECTION

- This unit uses either AC100V or AC200V.  
Since connecting the 200V to the 100V terminal (N<sub>1</sub>) can cause the unit to be damaged, be careful not to connect the power source incorrectly.  
Also, make it a rule to turn on/off the AC power source of the unit together with the power source for the basic unit of the programmable controller.
- Connect the earth terminal of the unit to that of the programmable controller basic unit, and earth the basic unit side.  
Use a wire of over 2mm<sup>2</sup> (AWG 14) for the earth, and execute the class-3 grounding (100Ω and less).  
Do not connect the ground terminal of the unit to the same ground plane use by high-voltage systems.  
Where grounding may be difficult, the equipment can be used without grounding.
- A replacement fuse is located inside the top left cover of the unit.  
Fuse: 250V, 1A, 5.3φ×20 glass tube fuse

## CONNECTION OF TRANSMISSION LINE

### ■ For F-16NP-E

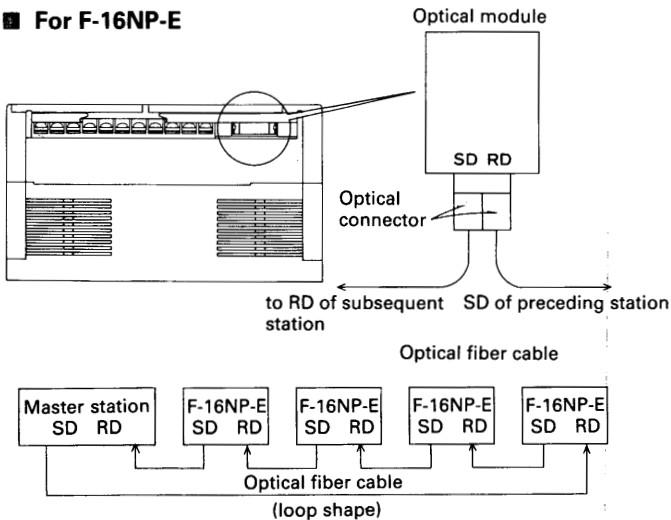

When using optical fiber cables, insert the optical connector into the SD (Send data), RD (Receive data) of the optical module. Connect the SD cable of the preceding station to RD, and the SD connection of the subsequent station, creating a communication loop.

In this case, marking one side of the optical fiber cable during the execution of wiring will assure correct cable connection for the entire communication loop.

### ■ For F-16NT-E

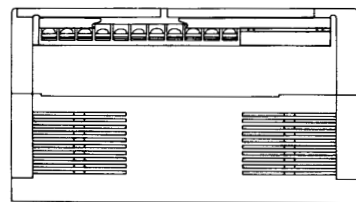

When using the twist pair cable, connect one wire from SDA terminal to RDA terminal of the next station, from SDB terminal to RDB terminal of the next station, from RDA terminal to SDA terminal of the preceding station, and from RDB terminal to SDB terminal of the preceding station.

Connect SG terminal commonly to all F-16NT-E.

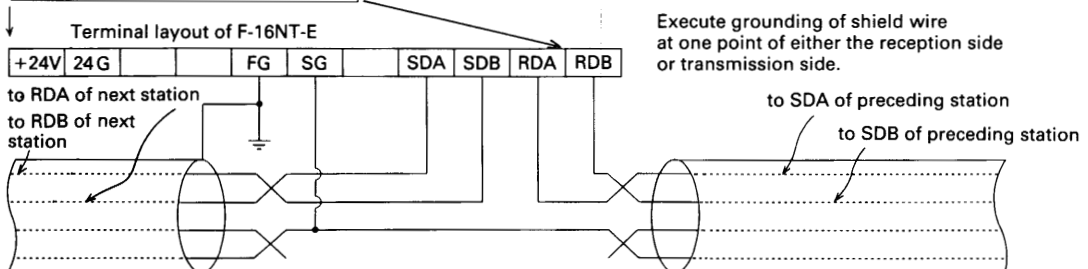

Execute grounding of shield wire at one point of either the reception side or transmission side.



## EXAMPLE CABLES

### Optical fiber cable

Manufacturers	Type names	Remarks
HITACHI LTD.	AP980-1000-A11	PVC-covered core cable ( $\phi 0.2\text{mm}$ )
	AP980-1000-B11	Reinforced PVC-covered core cable ( $\phi 5.0\text{mm}$ )
	AP980-1000-C11	PE-covered core cable ( $\phi 2.2\text{mm}$ )
MITSUBISHI RAYON CO., LTD.	EHV4001	PVC-covered core cable ( $\phi 2.2\text{mm}$ )
	EHTT4001	Reinforced PVC-covered core cable ( $\phi 5.0\text{mm}$ )
	EH4001	PE-covered core cable ( $\phi 2.2\text{mm}$ )
TORAY INDUSTRIES, INC.	PF-U-CL1001-V-T	Reinforced PVC-covered core cable ( $\phi 5.0\text{mm}$ )
	PF-U-CD1001	PE-covered core cable ( $\phi 2.2\text{mm}$ )
MITSUBISHI CABLE IND. LTD.	2VTPE-1	Optical compound vinyl insulated vinyl sheath cable (Compound cable made up of one optical fiber core and two wire cores)

### Twist pair cable

Manufacturers	Type names	Remarks
MITSUBISHI CABLE IND. LTD.	SPEV (SB)-0.2-2P	2-core cable ( $\phi 0.2\text{mm}$ )
	SPEV (SB)-0.5-2P	2-core cable ( $\phi 0.5\text{mm}$ )
SHOWA ELECTRIC WIRE & CABLE CO., LTD.	KMPEV-SB CWS-178 0.2SQ $\times$ 2P	2-core cable ( $\phi 0.2\text{mm}$ )
	KMPEV-SB CWS-178 0.5 $\times$ 2P	2-core cable ( $\phi 0.5\text{mm}$ )
SUMITOMO ELECTRIC INDUSTRIES, LTD.	DPEV SB 0.3 $\times$ 3P	3-core cable ( $\phi 0.3\text{mm}$ )
	DPEV SB 0.5 $\times$ 3P	3-core cable ( $\phi 0.5\text{mm}$ )
FURUKAWA ELECTRIC CO., LTD.	D-KPEV-SB 0.2 $\times$ 3P	3-core cable ( $\phi 0.2\text{mm}$ )
	D-KPEV-SB 0.5 $\times$ 3P	3-core cable ( $\phi 0.5\text{mm}$ )
FUJIKURA CABLE WORKS, LTD.	IPEV-SB 0.3mm <sup>2</sup> $\times$ 2P	2-core cable ( $\phi 0.3\text{mm}$ )
	IPEV-SB 0.5mm <sup>2</sup> $\times$ 2P	2-core cable ( $\phi 0.5\text{mm}$ )

**Note: For cable arrangement, consult your local representative**

# 4 Installation and wiring (general)

## INSTALLATION DIMENSION

### [1] Direct installation method

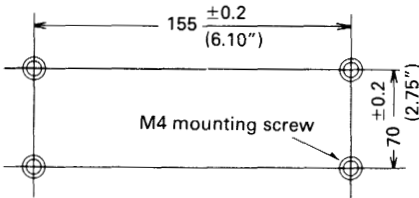

### [2] DIN rail installation method

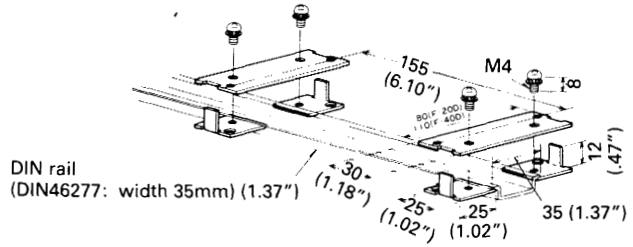

Do not attempt to install the equipment on a floor surface or on a ceiling surface. This will defeat the cooling system. Be sure to install it on a wall surface.

DIN mounting attachments are made up of two set assemblies.

Set one on the right and left of the rail temporarily, mount the programmable controller, and then tighten them with screws.

## DIMENSION OF WIRING TERMINAL

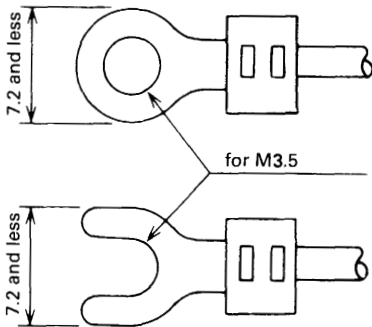

Tighten the solderless terminal at the following torque.

M3.5: 5~8kg·cm (4ft/lb.)

## INSTALLATION OF EXTENSION CABLE

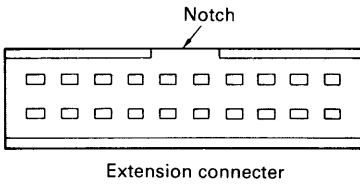

Remove the connector cover from the right side of the unit prior to connecting the cable both to the basic unit and the interface unit.

Since the connectors at both side of the extension cable are provided with projection to prevent the cable from being inserted in correctly, keep the projection directed upward and mate it with the notch of the unit.

Either end of the cable may be located at the cable unit side or the interface unit side.

Since the extension cable may be readily affected by noise, be sure to keep it separated from the other electrical wiring by more than 30mm~50mm. (1.2~2 inches)

## PRECAUTIONS ON INSTALLATION

Environmental conditions

Do not attempt to install the unit in a place where there is any dust, carbon black, conductive dust, corrosive gas, etc.

Do not install the unit where vibration or shock may be applied.

Do not install the unit near a heat source or where condensation may occur, or exposed to rain and wind or direct sunshine.

Installation

When performing tapping or wiring, be careful not to allow any cuttings or wire pieces to enter the unit.

The ventilation louvers of the unit is covered with a dust-proof sheet.

After completing installation, be sure to remove this sheet to allow the unit to dissipate heat.

Be sure to keep all wiring away from high-tension lines, high-voltage units, drive units, etc. as much as possible.

# 5 Programming

## ALLOTMENT OF LINK DATA

8-point in/8-point out data is received/transmitted between the local programmable controller (F/F<sub>1</sub>/F<sub>2</sub>) and the master programmable controller-A.

The 8-point in/8-point out link data in the local programmable controller (F/F<sub>1</sub>/F<sub>2</sub>) is allotted as shown in the following table.

Link data	F/F <sub>1</sub> /F <sub>2</sub> →A	A→F/F <sub>1</sub> /F <sub>2</sub>
Extension configuration		
When extension, cable is connected to 400"s	Y440~Y447	X420~X427
When extension cable is connected to 500"s	Y540~Y547	X540~X527
When extension cable is connected to 000"s	Y040~Y047	X020~X027

## LINK DATA FLOW

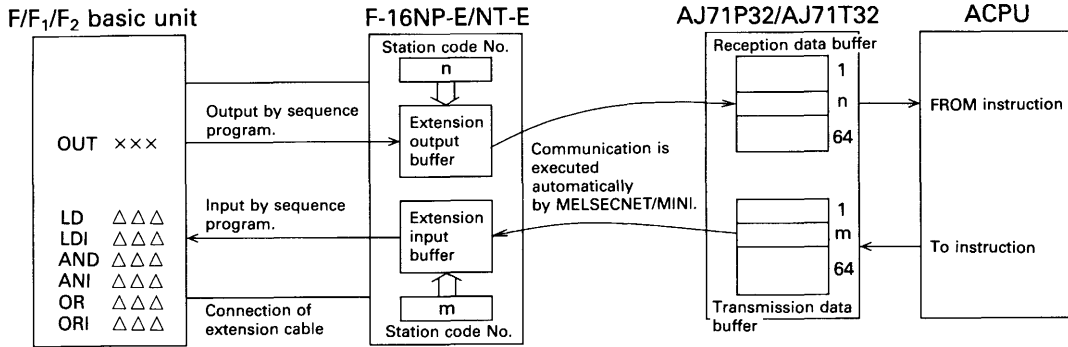

When the OUT instruction is executed using the extension output number to which the extension cable is connected from the F/F<sub>1</sub>/F<sub>2</sub> extension unit, the data is outputted to the extension output buffer of the interface unit F-16NP-E/NT-E.

The MELSECNET/MINI link system serves to store it at the reception buffer of master station AJ71P32/AJ71T32 as data for the station code number set in the output data.

When the reception buffer is read by the CPU of programmable controller-A with a FROM instruction, the data of F/F<sub>1</sub>/F<sub>2</sub> is transmitted to the ACPU.

The data outputted to the master station AJ71P32/AJ71T32 by the ACPU with a TO instruction is inputted to the extension input buffer by the MELSECNET/MINI link system according to the station code number set in the input data of interface unit F-16NP-E/NT-E.

The F/F<sub>1</sub>/F<sub>2</sub> controllers access the data from the link system via the F-16NP-E/NT-E unit. When the ladder commands e.g. LD, LDI etc. are used with the appropriate extension element, manipulation of data from A-series PLC's can be made.

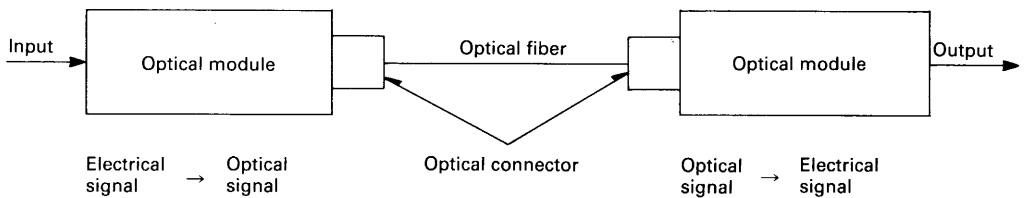

“Optical communication” is transmission of information from one equipment to the other by using light.

The electrical digital value of “ON” or “OFF” is converted (presence/absence of light) by the optical module from electric signal into optical signal, and the optical signal is transmitted to the fiber cable through the optical connector.

The optical information sent through the fiber cable is received by the optical module through the optical connector, where it is converted from optical signal into electrical signal, and then transmitted as an electrical digital value.

# PROGRAM EXAMPLE Configuration

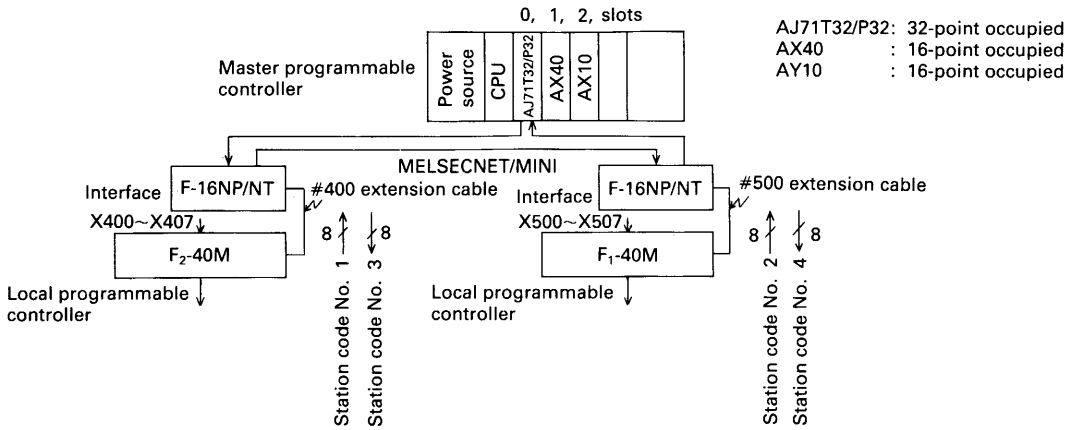

## Function

- (1) Outputs the input data of X400~X407 sent from the F<sub>2</sub>-40M programmable controller to the AY10 of the master programmable controller. (A)
- (2) Outputs the input data of AX40 sent from the master programmable controller to Y530~Y537 of the F<sub>1</sub>-40M programmable controller. (B)
- (3) Outputs the input data of X500~X507 sent from the F<sub>1</sub>-programmable controller to Y430~Y437 of the F<sub>2</sub>-40M programmable controller. (C)

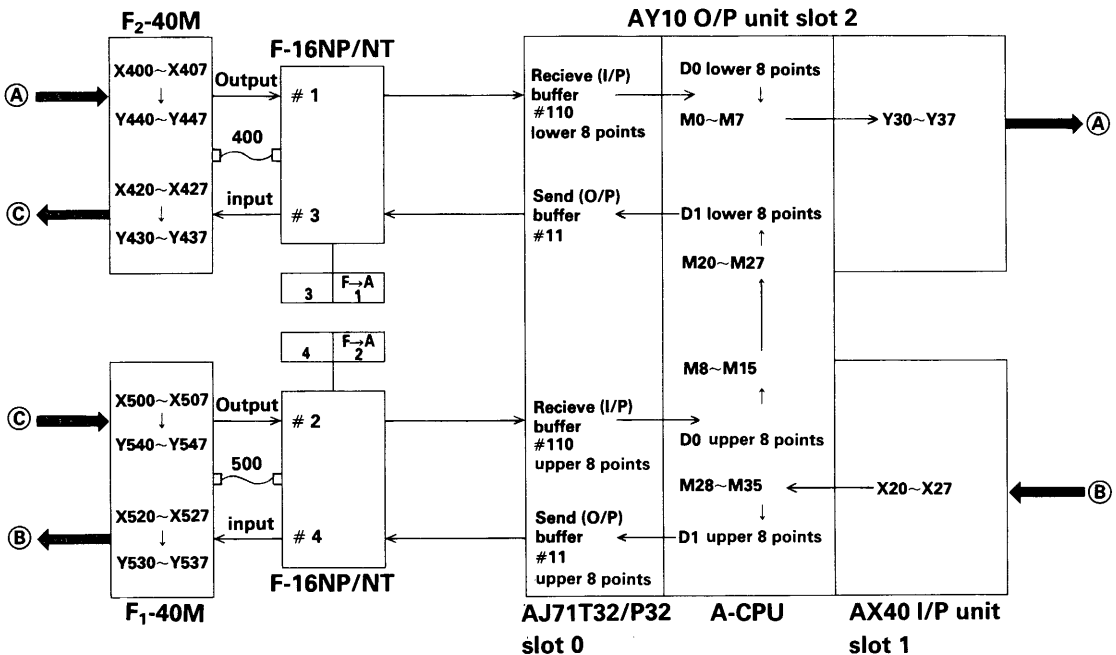

## Program

F<sub>2</sub>-40M program

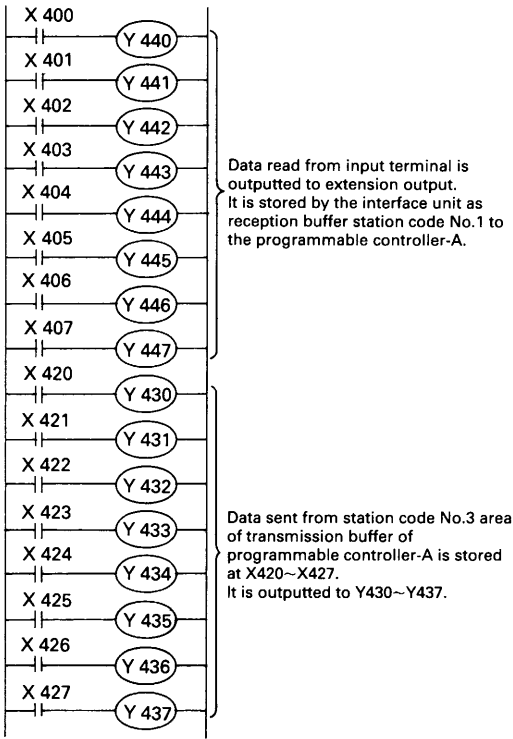

F<sub>1</sub>-40M program

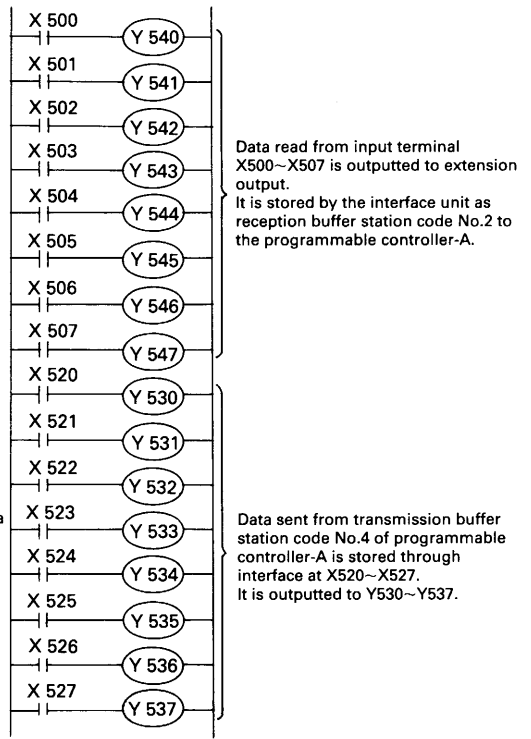

## SPECIAL RELAY IN F/F<sub>1</sub>/F<sub>2</sub>

Element Nos.	Signal names
X□14	Input refresh normal
X□15	Input refresh abnormal
X□16	output refresh normal
X□17	output refresh abnormal

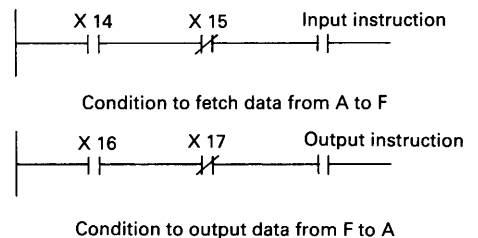

- extension port no. e.g. 0,4,5 to which Interface unit is connected. These transfer status elements are automatically assigned when the interface unit F.16NP/NT is connected

# A series CPU

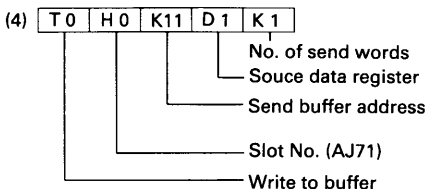
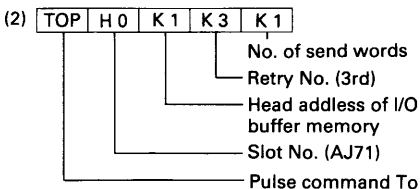
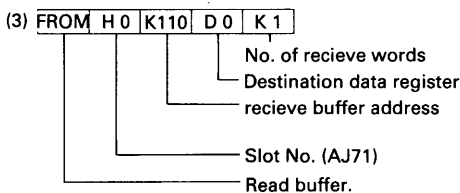
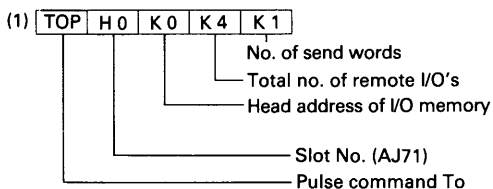
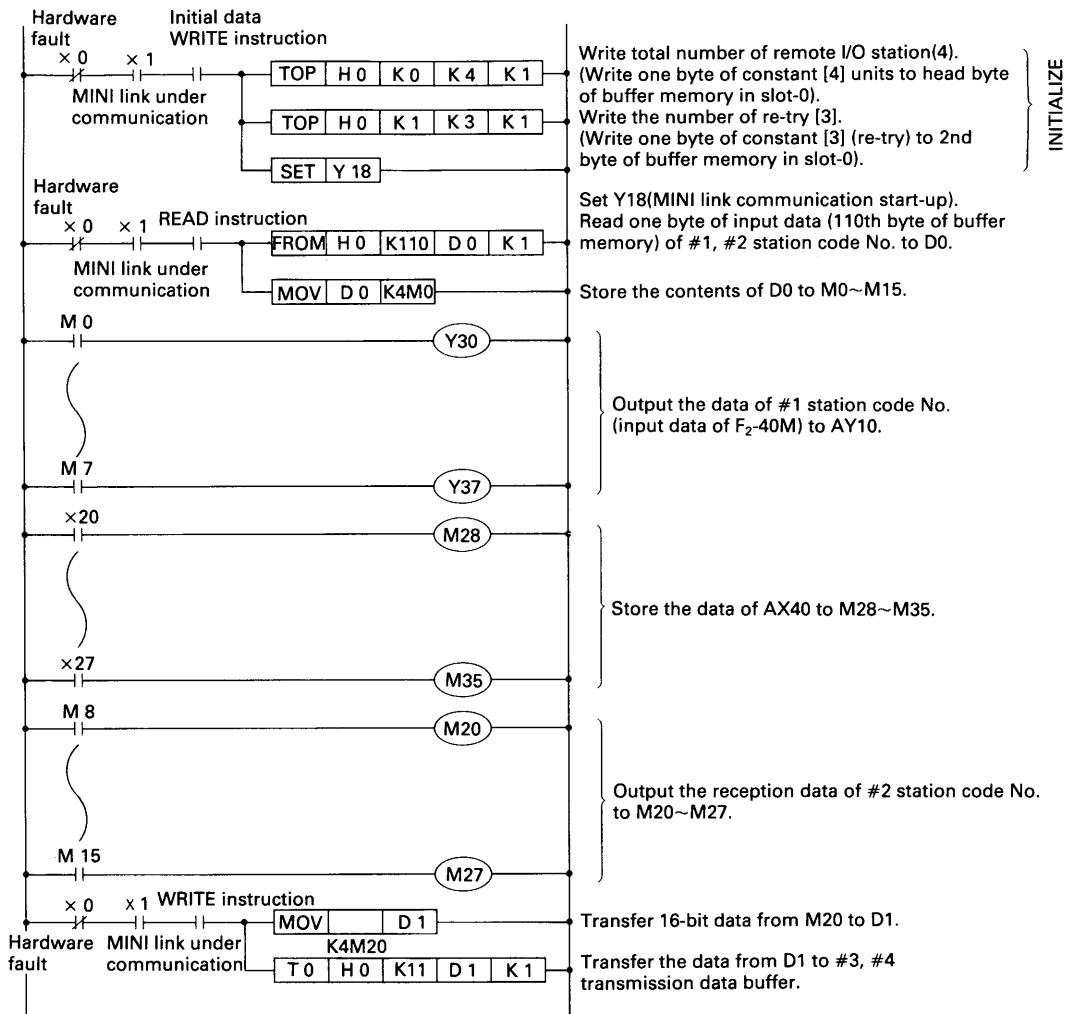



## SPECIAL RELAY IN PROGRAMMABLE CONTROLLER-A

### List of input/output signals when AJ71 station is inserted to slot-0

Device No.	Signal names	Device No.	Signal names
X0	Hardware fault	Y0 ~ Y17	Not used
X1	Under MINI link communication	Y18	MINI link communication start-up
X2	Not used	Y19	Not used
X3		Y1A	Designation of FROM/TO instruction response
X4		Y1B	Designation of data clear for fault station
X5	Test mode		
X6	Detection of MINI link fault	Y1C	Not used
X7	MINI link communication fault	Y1D	Fault reset
X8 ~ X1F	Not used	Y1E	Not used
		Y1F	

The special contact and relay used for the MELSECNET/MINI are as shown in the above table. Numbers shown above are those when the master station is inserted to slot-0.

## SPECIFICATIONS

## Performance specifications

Items	Optical data link	Twist pair link	Remarks																		
Interface unit	F-16NP-E	F-16NT-E																			
Master station	AJ171P32	AJ71T32																			
Cable	Plastic fiber (station-to-station distance:50m)	Twist pair cable with shield (station-to-station distance:100m)																			
Number of station occupied	2 stations (for 8-point input and 80point output)		In conformity to MELSECNET/MINI																		
Number of input points and allotment	8 points (X420~X427, X520~X527 or X020~X027)		Transfer from master programmable controller to local programmable controller																		
Number of output points and allotment	8 points (Y440~Y447, Y540~Y547 or Y040~Y047)		Transfer from local programmable controller to master programmable controller																		
Operation state indication LED	<table border="1"> <thead> <tr> <th>LEDs</th> <th>Contents</th> </tr> </thead> <tbody> <tr> <td>14</td> <td>Turned on upon reception of input data successfully.</td> </tr> <tr> <td>15</td> <td>Turned on upon reception of input data unsuccessfully.</td> </tr> <tr> <td>16</td> <td>Turned on upon transmission of output data successfully.</td> </tr> <tr> <td>17</td> <td>Turned on upon transmission of output data unsuccessfully.</td> </tr> <tr> <td>SD,RD</td> <td>Flickering during data transmission/reception</td> </tr> <tr> <td>PC</td> <td>Turned on while programmable controller and interface are normal</td> </tr> <tr> <td>20~27</td> <td>Input data</td> </tr> <tr> <td>40~47</td> <td>Output data</td> </tr> </tbody> </table>		LEDs	Contents	14	Turned on upon reception of input data successfully.	15	Turned on upon reception of input data unsuccessfully.	16	Turned on upon transmission of output data successfully.	17	Turned on upon transmission of output data unsuccessfully.	SD,RD	Flickering during data transmission/reception	PC	Turned on while programmable controller and interface are normal	20~27	Input data	40~47	Output data	<b>While in normal operation</b> PC, 14 and 16 are turned on, SD and RD flicker, and 15 and 17 are turned off. 14~17 may be entered by sequence program.
	LEDs	Contents																			
	14	Turned on upon reception of input data successfully.																			
	15	Turned on upon reception of input data unsuccessfully.																			
	16	Turned on upon transmission of output data successfully.																			
	17	Turned on upon transmission of output data unsuccessfully.																			
	SD,RD	Flickering during data transmission/reception																			
	PC	Turned on while programmable controller and interface are normal																			
	20~27	Input data																			
40~47	Output data																				
Remote error	A remote error will occur at the master station when the power source to the programmable controller or interface is turned off, when any CPU error occurs, or when the extension cable is not connected.		When the PC LED is turned off, this error is generated.																		
Reset/hold	It is possible to hold or reset the data when the faults such as communication, etc. occur, (causing the I/O refresh by the master station to be interrupted.)																				

## Power specifications

Items	Specifications	Remarks
Power source used for communication	DC15.6V~DC31.2V, 0.05A	Power source used for communication is insulated from that used for the interface.
Power source used for interface	AC110~120V/220~240V $\pm 10\%$ $\pm 15\%$ 10VA	

## General specifications

Items	Contents
Operating ambient temperature	0~55°C
Operating ambient humidity	45~85% (No condensation)
Vibration-proof	10~55Hz, 0.5mm(max. 2G) 2 hours to each direction of 3 axes (as per JIS C0911)
Shock-proof	10G for 3 times to each direction of 3 axes (as per JIS C0912)
Noise resistance	1,000V, 1μs (by noise simulator)
Dielectric strength	AC150V, for one minute
Insulation resistance	10MΩ (DC500V megger)
Earth (Grounding)	Class-3 earth
Operating atmosphere	Must be free from corrosive gas or excessive dust.

# OUTSIDE DIMENSIONS

## F-16NP-E

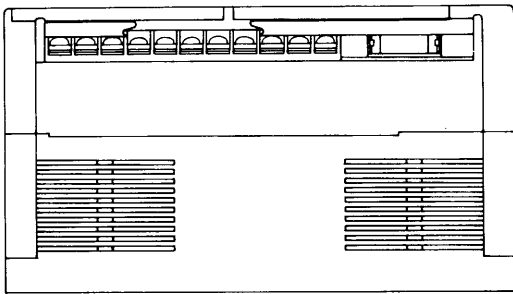
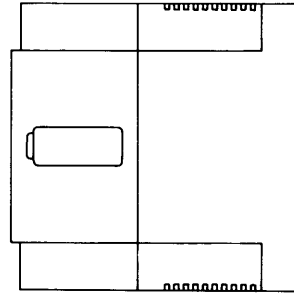
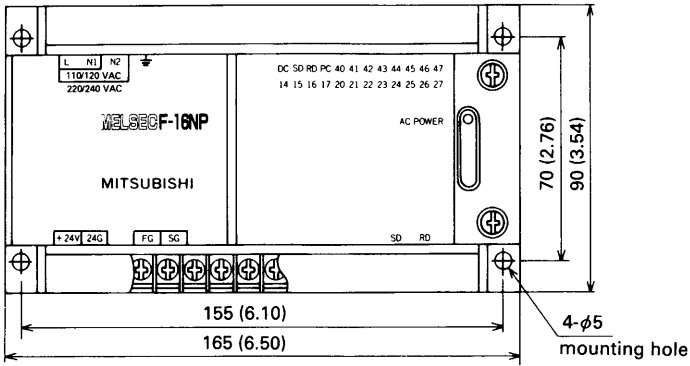

## F-16NT-E

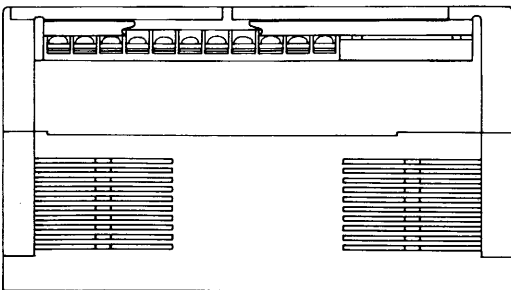
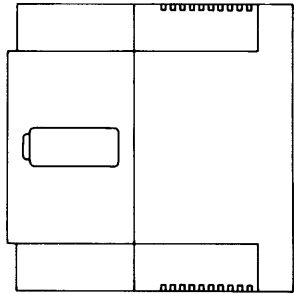
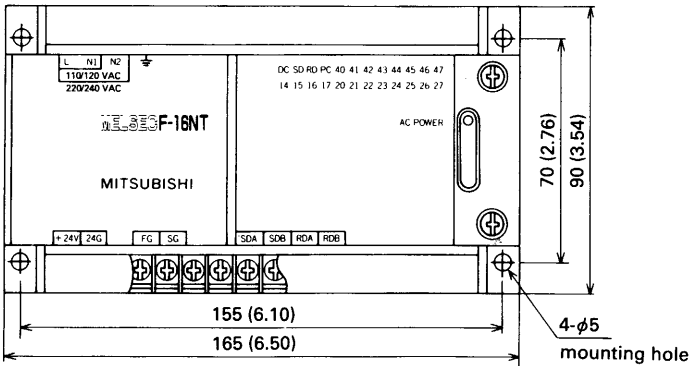

mm (inch)





# Summary of settings

## Setting of station code No.

SW2	SW3	SW4	SW5
X10	X1	X10	X1
Station code No. (A → F)		Station code No. (F → A)	

## Reset/hold

SW1	E.C.MODE
ON	 (RESET)
OFF	 (HOLD)

## Link data Status

	400	500	000
DATA (A → F)	X420~X427	X520~X527	X020~X027
DATA (F → A)	Y440~Y447	Y540~Y547	Y040~Y047

	Contents	When normal
PC	Programmable controller normal	ON
RD	Under data reception	Flickering
SD	Under data transmission	Flickering
DC	DC power source	ON

	Contents	400	500	000	When normal
X-RUN	A→F input normal	X414	X514	X014	ON
X-ERROR	A→F input abnormal	X415	X515	X015	OFF
Y-RUN	F→A output normal	X146	X516	X016	ON
Y-ERROR	F→A output abnormal	X417	X517	X017	OFF

# DIAGNOSIS FLOWCHART

## ■ RD/SD of interface unit fail to flicker

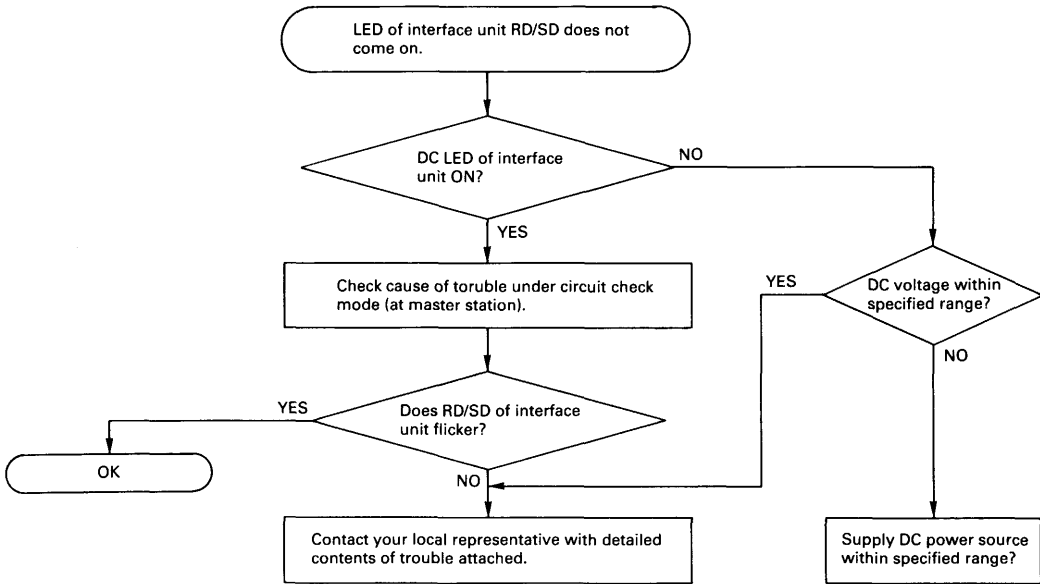

■ Input to interface unit is not successful.

(Programmable controller-F fails to receive data from programmable controller-A)

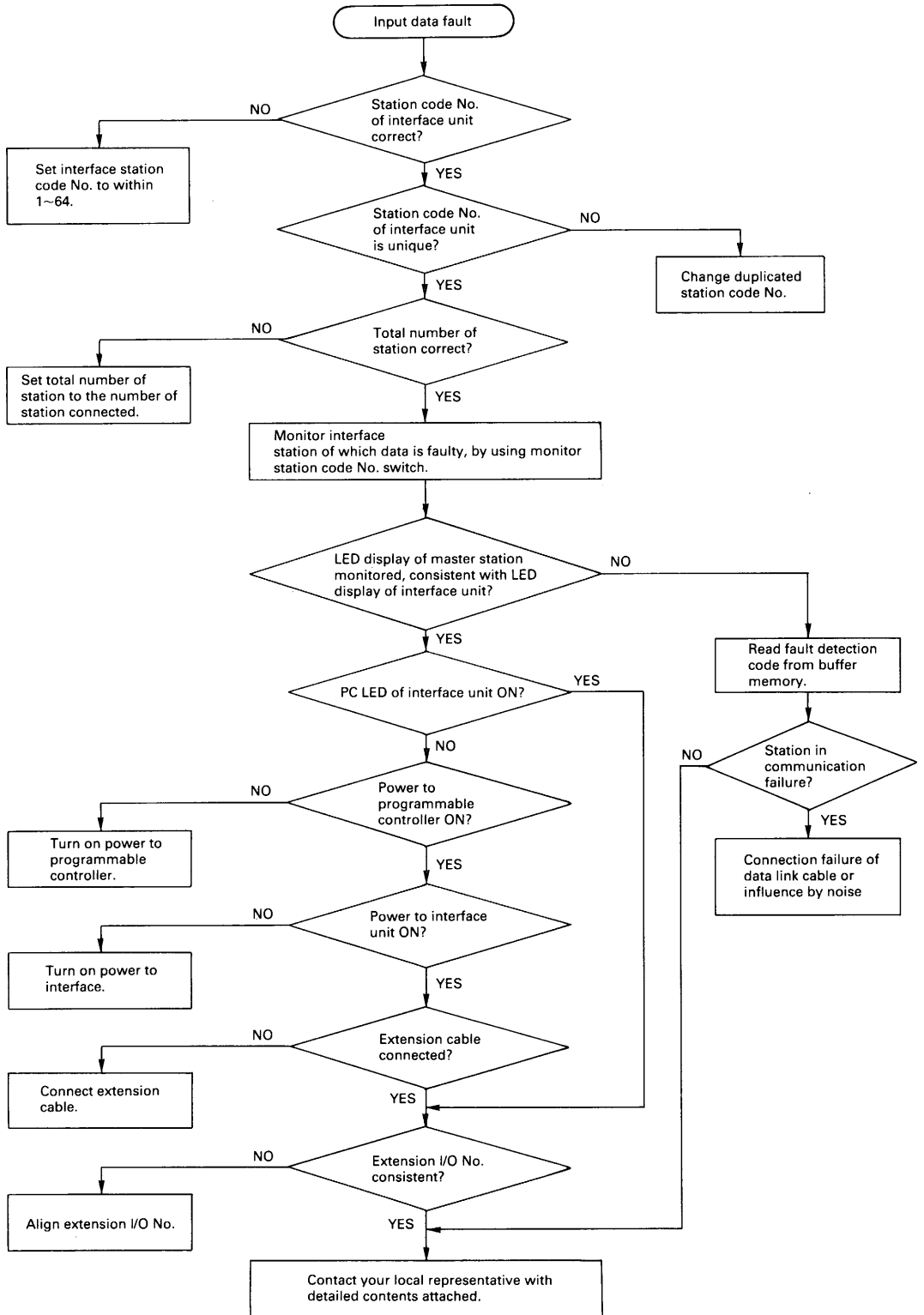

■ **Output from interface unit is not successful (Programmable controller-F fails to receive data from programmable controller-F)**

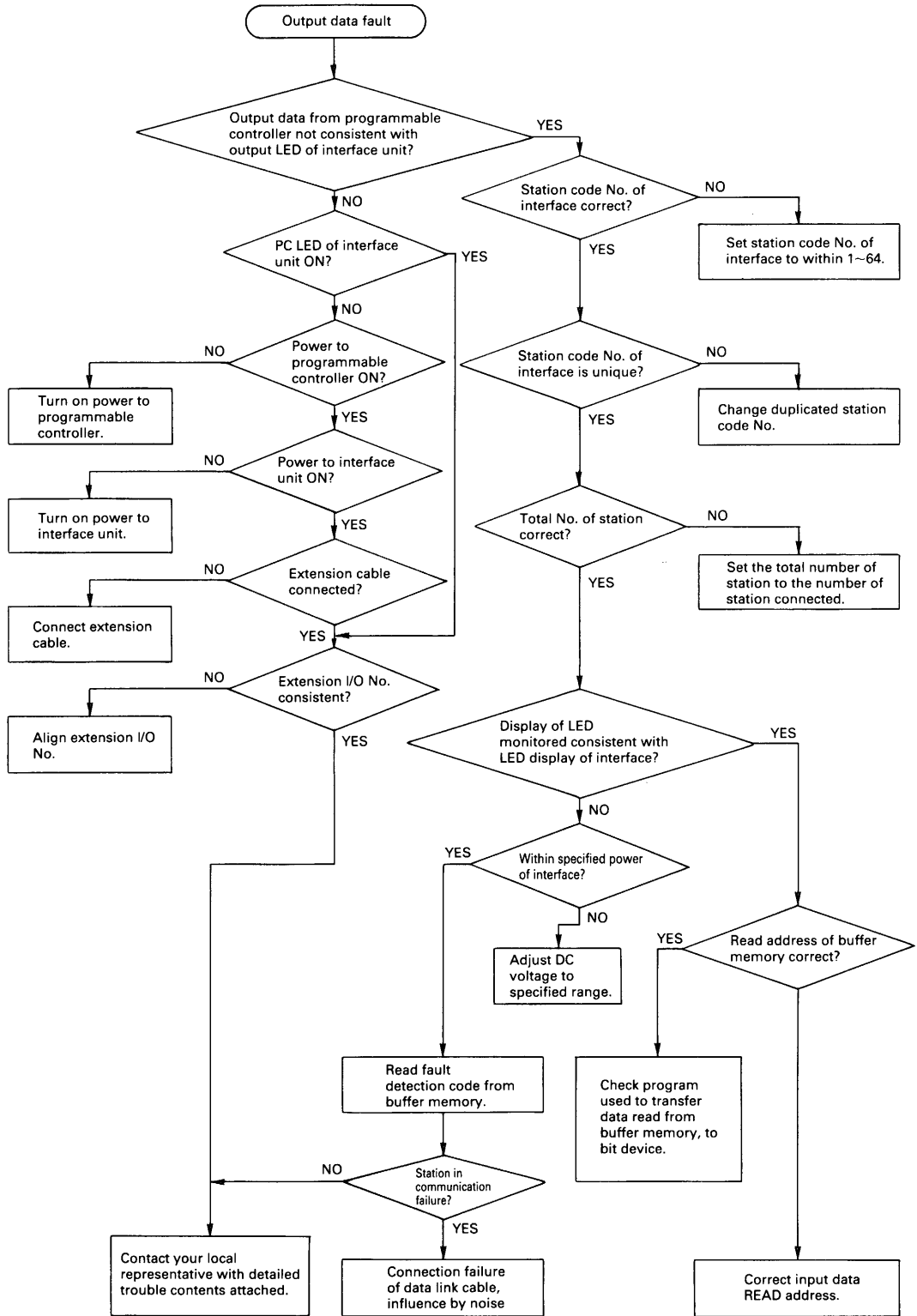



# MEMO

A series of horizontal dotted lines for writing.

# MEMO

A series of horizontal dotted lines for writing.

 **MITSUBISHI ELECTRIC CORPORATION**  
HEAD OFFICE: MITSUBISHI DENKI BLDG., MARUNOUCHI, TOKYO 100. TELEX: J24532 CABLE: MELCO TOKYO

---