

Side
B

JY997D32301C

Side
A

JAPANESE

Side
B

ENGLISH



Changes for the Better

FX3G-CNV-ADP

INSTALLATION MANUAL



Manual Number	JY997D32301
Revision	C
Date	November 2008

This manual describes the part names, dimensions, mounting, and specifications of the product. Before use, read this manual and the manuals of all relevant products fully to acquire proficiency in handling and operating the product. Make sure to learn all the product information, safety information, and precautions.

Store this manual in a safe place so that it can be taken out and read whenever necessary. Always forward it to the end user.

Registration:

The company and product names described in this manual are registered trademarks or the trademarks of their respective companies.

Effective November 2008

Specifications are subject to change without notice.

© 2008 Mitsubishi Electric Corporation

Safety Precaution (Read these precautions before use.)

This manual classifies the safety precautions into two categories:

⚠ DANGER and **⚠ CAUTION**.

⚠ DANGER	Indicates that incorrect handling may cause hazardous conditions, resulting in death or severe injury.
⚠ CAUTION	Indicates that incorrect handling may cause hazardous conditions, resulting in medium or slight personal injury or physical damage.

Depending on the circumstances, procedures indicated by **⚠ CAUTION** may also cause severe injury.

It is important to follow all precautions for personal safety.

Associated Manuals

Manual name	Manual No.	Description
FX3G Series User's Manual - Hardware Edition	JY997D31301 MODEL CODE: 09R521	Explains the FX3G Series PLC specifications for I/O, wiring, installation, and maintenance.

How to obtain manuals

For product manuals or documents, consult with the Mitsubishi Electric dealer from who you purchased your product.

1. Outline

The FX3G-CNV-ADP special adapter connection conversion adapter (hereinafter called connector conversion adapter) is a special adapter connection conversion adapter for connecting the analog and communication special adaptors to the main unit of a PLC.

1.1 Incorporated Items

Product	FX3G-CNV-ADP special adapter connection conversion adapter
Included items	M3×8 tapping screws for installation: 4 pcs. Side cover Installation Manual (This manual)

1.2 External Dimensions and Part Names

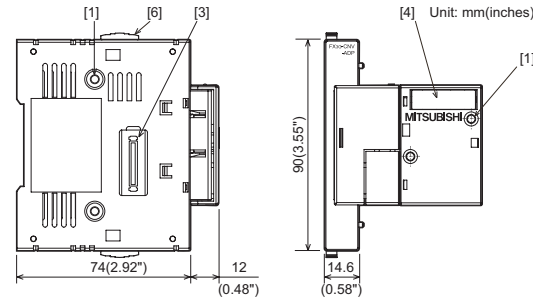

Connector cover is removed

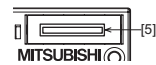

- [1] Mounting connector
- [2] Main unit connector
- [3] Special adapter connector
- [4] Connector cover
- [5] Memory cassette/Display module connector
- [6] Special adapter slide lock

MASS(Weight): 0.1kg(0.22lbs)

2. Installation

INSTALLATION PRECAUTIONS **⚠ DANGER**

- Make sure to cut off all phases of the power supply externally before attempting installation or wiring work. Failure to do so may cause electric shock or damage to the product.

INSTALLATION PRECAUTIONS **⚠ CAUTION**

- Use the product within the generic environment specifications described in PLC main unit manual (Hardware Edition). Never use the product in areas with excessive dust, oily smoke, conductive dusts, corrosive gas (salt air, Cl₂, H₂S, SO₂, or NO₂), flammable gas, vibration or impacts, or expose it high temperature, condensation, or rain and wind. If the product is used in such conditions, electric shock, fire, malfunctions, deterioration or damage may occur.
- Use screwdrivers carefully when performing installation work, thus avoiding accident or product damage.
- When drilling screw holes or wiring, make sure cutting or wire debris does not enter the ventilation slits. Failure to do so may cause fire, equipment failures or malfunctions.
- Do not touch the conductive parts of the product directly. Doing so may cause device failures or malfunctions.
- Connect the adapter securely to their designated connectors. Loose connections may cause malfunctions.

The following section describes the installation method to the FX3G Series PLC (FX3G-24M□). In this example.

For more details on installation and removal, refer to the following manual.

→ Refer to the FX3G Series User's Manual - Hardware Edition

2.1 Installation Method

1) Turn the power supply OFF.
Remove the top cover (A in the figure on the right) and peripheral equipment connector cover (B in the figure on the right) from the front of the main unit.

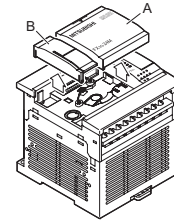

For 40/60-point types, refer to the following manual.

→ Refer to the FX3G Series User's Manual - Hardware Edition

2) Attach the provided side cover (C in the figure on the right).

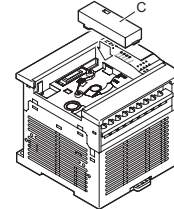

For the 40/60-point types, it is not necessary to attach the side cover.

3) Connect the connector conversion adapter to the optional equipment connector (D in the figure on the right), and fix it using the provided M3 tapping screws (E in the figure on the right).

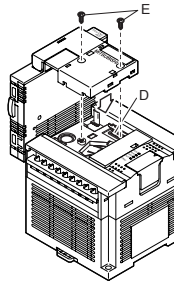

Tightening torque : 0.3 to 0.6 N·m

4) Fix the connector conversion adapter (F in the right figure) to the main unit using provided M3 tapping screws (E in the figure on the right).

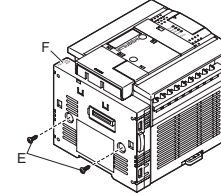

Tightening torque : 0.3 to 0.6 N·m

2.2 Cable connection

When connecting a cable to the standard built-in port (RS-422, USB) always, cut off the part A shown in the right figure using snippers, etc. For details, refer to the following manual.

→ Refer to the FX3G Series User's Manual - Hardware Edition

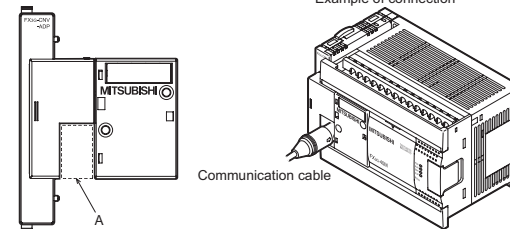

3. Specifications

STARTUP AND MAINTENANCE PRECAUTIONS **⚠ CAUTION**

- Do not disassemble or modify the PLC. Doing so may cause fire, equipment failures, or malfunctions. * For repair, contact your local Mitsubishi Electric distributor.
- Do not drop the product or exert strong impact to it. Doing so may cause damage.

DISPOSAL PRECAUTIONS **⚠ CAUTION**

- Please contact a certified electronic waste disposal company for the environmentally safe recycling and disposal of your device.

TRANSPORT AND STORAGE PRECAUTIONS **⚠ CAUTION**

- The product is a precision instrument. During transportation, avoid any impacts. Failure to do so may cause failures in the product. After transportation, verify the operations of the product.

3.1 Applicable PLC

Model name	Applicability
FX3G Series PLC	Ver.1.00 or later (from first production)

For details on the system configuration, refer to the following manual.

→ Refer to the FX3G Series User's Manual - Hardware Edition

3.2 General Specifications

The general specifications are equivalent to the PLC main unit.

For general specifications, refer to the following manuals.

→ Refer to the FX3G Series User's Manual - Hardware Edition

This manual confers no industrial property rights or any rights of any other kind, nor does it confer any patent licenses. Mitsubishi Electric Corporation cannot be held responsible for any problems involving industrial property rights which may occur as a result of using the contents noted in this manual.

Warranty

Mitsubishi will not be held liable for damage caused by factors found not to be the cause of Mitsubishi; opportunity loss or lost profits caused by faults in the Mitsubishi products; damage, secondary damage, accident compensation caused by special factors unpredictable by Mitsubishi; damages to products other than Mitsubishi products; and to other duties.

⚠ For safe use

- This product has been manufactured as a general-purpose part for general industries, and has not been designed or manufactured to be incorporated in a device or system used in purposes related to human life.
- Before using the product for special purposes such as nuclear power, electric power, aerospace, medicine or passenger movement vehicles, consult with Mitsubishi Electric.
- This product has been manufactured under strict quality control. However when installing the product where major accidents or losses could occur if the product fails, install appropriate backup or failsafe functions in the system.

MITSUBISHI ELECTRIC CORPORATION

HEAD OFFICE : TOKYO BUILDING, 2-7-3 MARUNOUCHI, CHIYODA-KU, TOKYO 100-8310, JAPAN
HIMEJI WORKS : 840, CHIYODA CHO, HIMEJI, JAPAN