

MITSUBISHI *Changes for the Better*
PROGRAMMABLE CONTROLLERS
MELSEC-F

FX2NC-ENET-ADP Ethernet adapter

USER'S MANUAL

Manual Number	JY997D12301
Revision	D
Date	May 2007



• This manual contains text, diagrams and explanations which guide the reader in the correct installation and operation of the FX2NC-ENET-ADP Ethernet adapter. It should be read and understood before attempting to use the unit.
 • If in doubt at any stage of the installation of FX2NC-ENET-ADP, consult a professional electrical technician who is qualified and trained to the local and national standards which apply to the installation site.
 • If in doubt about the operation or use of the FX2NC-ENET-ADP, please consult the nearest Mitsubishi Electric distributor.
 • This manual is subject to change without notice.
 • Microsoft® and Windows® are either registered trademarks or trademarks of Microsoft Corporation in the United States and/or other countries.
 • The company name and the product name described in this manual are the registered trademarks or trademarks of each company.

Guideline for the safety of the user and protection of the FX2NC-ENET-ADP.
 This manual provides usage information for the FX2NC-ENET-ADP Ethernet adapter. The manual has been written to be used by trained and competent personnel.

Notes on the symbols used in this manual

At various times throughout out this manual certain symbols will be used to highlight points of information which are intended to ensure the users personal safety and protect the integrity of equipment. Whenever any of the following symbols are encountered, its associated note must be read and understood. Each of the symbols used will now be listed with a brief description of its meaning.

Hardware Warnings

-  1) Indicates that the identified danger **WILL** cause physical and property damage.
-  2) Indicates that the identified danger could **POSSIBLY** cause physical and property damage.
-  3) Indicates a point of further interest or further explanation.

DISPOSAL PRECAUTIONS

- When disposing of this product, treat it as industrial waste.

INSTALLATION PRECAUTIONS

- Use the module in an environment that meets the general specifications contained in this manual. Using this module in an environment outside the range of the general specifications could result in electric shock, fire, erroneous operation, and damage to or deterioration of the product.
- Do not disassemble or modify the module. Doing so may cause failure, malfunction, injury, or fire.

TRANSPORTATION AND MAINTENANCE PRECAUTIONS

- During transportation avoid any impact as the module is a precision instrument. Doing so could cause trouble in the module.
- It is necessary to check the operation of module after transportation, in case of any impact damage.

Note Concerning the CE Marking
 The CE marking does not guarantee that an entire mechanical module produced in accordance with the contents of the notification comply with the following standards. Compliance to EMC standards of the entire mechanical module should be checked by the user / manufacturer.

Standards with which this product complies
 Type: Programmable Controller (Open Type Equipment)
 Models: Products manufactured:
 from April 1st, 2004 to April 30th, 2006 are compliant with EN61000-6-4 and EN61131-2:1994+A11:1996+A12:2000 and EN61000-6-2 after May 1st, 2006 are compliant with EN61131-2:2003

Electromagnetic Compatibility Standards (EMC)	Remark
EN61000-6-4:2001 Electromagnetic compatibility -Generic standards - Emission standard for Industrial environment	Compliance with all relevant aspects of the standard. (Radiated Emissions and Mains Terminal Voltage Emissions)
EN61131-2:1994/A11:1996/A12:2000 Programmable controllers -Equipment requirements and tests	Compliance with all relevant aspects of the standard. (RF Immunity, Fast transients, ESD and Damped oscillatory wave)
EN61000-6-2:2001 Electromagnetic compatibility -Generic standards Immunity for industrial environments.	Compliance with all relevant aspects of the standard. (RF immunity, Fast transients, ESD, Conducted, Surges, Power magnetic fields, Voltage dips and Voltage interruptions)
EN61131-2: 2003 Programmable controllers -Equipment requirements and tests	Compliance with all relevant aspects of the standard. (Radiated Emissions, Mains Terminal Voltage Emissions, RF immunity, Fast Transients, ESD, Surge, Voltage drops and interruptions, Conducted and Power magnetic fields)

For more details please contact the local Mitsubishi Electric sales site.
 • Notes for compliance to the EMC regulation
 It is necessary to install the FX2NC-ENET-ADP module in a shielded metal control panel.

1. Associated Manuals

Manual name	Manual No.	Description
FX1S HARDWARE MANUAL	JY992D83901	
FX1N HARDWARE MANUAL	JY992D89301	Describes the hardware of the FX Series PLC such as specifications, wiring, and installation.
FX2N HARDWARE MANUAL	JY992D66301	
FX2NC HARDWARE MANUAL (DSS/DS) (D/UL)	JY992D76401 JY992D87201	
FX PROGRAMMING MANUAL II	JY992D88101	Describes the instructions available in the FX1S/FX1N/FX2N/FX2NC Series PLC.
FX Configurator-EN OPERATION MANUAL	JY997D20501	Describes operation details of FX Configurator-EN Configuration Software.
FX1N-CNV-BD Special Adapter Connection Board	JY992D84701	
FX2N-CNV-BD Special Adapter Connection Board	JY992D63601	Describes matters related to the installation of the boards.

For GX Developer and MX Component, refer to the operation manual respectively.

2. Outline of Product

The FX2NC-ENET-ADP is an Ethernet adapter of 10BASE-T specifications for the FX1S, FX1N, FX2N and FX2NC Series.
 The FX2NC-ENET-ADP enables the upload, download, monitor, and test of a program from the personal computer (GX Developer or MX Component) via Ethernet.

3. Installation

- Caution**
- Use only in the environments specified under the general specifications in the manual.
 - Do not use the product in environments with excessive or conductive dust, corrosive (including salt breeze, Cl₂, H₂S, SO₂, NO₂, etc.) or flammable gas, oily smoke, moisture or rain, excessive heat, regular impact shocks or excessive vibration, as it may result in electrical shock, fire, malfunction, damage or deterioration of the product.
 - Make sure to shut off the external power before installing or wiring it. Electric shock or serious damage to the product may occur, if the external power is not disconnected.
 - Never drop wire chips or shavings into the ventilation slits when drilling screw holes or performing wiring, as they may cause fire, breakdown, or malfunction.
 - Securely install the FX2NC-ENET-ADP to the designated port.
 - A poor connection may result in malfunction.

3.1 How to Install to FX Series PLC

Installation to FX1S/FX1N/FX2N
 Turn OFF the PLC before beginning any work.

- 1) Remove the panel cover from the top face of the main unit.
- 2) Take off the resin cover from the left side of the main unit.
- 3) Install the following board to the port on the main unit.

Board name	Corresponding model
FX1N-CNV-BD	FX1S/FX1N
FX2N-CNV-BD	FX2N

- 4) Affix the above board using the supplied M3 screws.
Tightening torque: 0.3 to 0.6 N·m
- 5) Connect the built-in cable of the FX2NC-ENET-ADP to the port on the left side of the board.

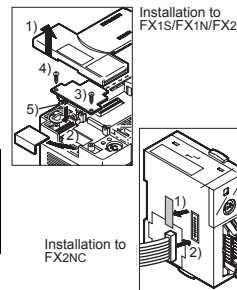

Installation to FX2NC
 Turn OFF the PLC before beginning any work.

- 1) Remove the cover from the special adapter port provided on the left side of the main unit.
- 2) Connect the built-in cable of the FX2NC-ENET-ADP to the special adapter port.

3.2 Installation to a Panel Face

Direct installation to the panel face
 Directly attach to the panel face using 2 sets of a screw (M4), a spring washer, and a flat washer in the mounting holes.
 Tightening torque: 0.7 to 1.0 N·m
 For the pitch and positions of mounting screw holes, refer to the external dimensions.

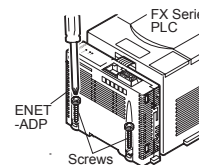

Mounting on DIN rail
 Affix the FX2NC-ENET-ADP to the DIN rail, DIN46277 (35 mm (1.37") wide).

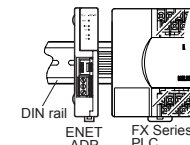

Dismounting from DIN rail
 Slightly pull down the DIN rail mounting clip using a tool such as a slotted screwdriver. Pull down the clip further, and the rail will be locked with the clip left open.

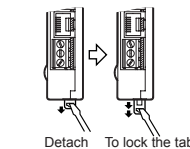

4. System Configuration

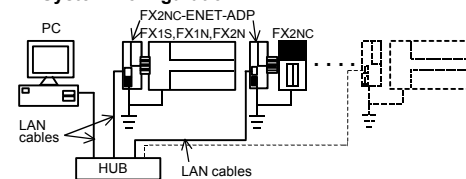

PLC	Ethernet adapter	LAN cable
FX1S/FX1N PLC + FX1N-CNV-BD		
FX2N PLC + FX2N-CNV-BD	FX2NC-ENET-ADP	Twisted pair cable Category 5(e) STP or 3 STP (straight cable)
FX2NC PLC		

• Applicable version of GX Developer/MX Component

Software	Applicable Version	With FX Configurator-EN
GX Developer	Ver. 8.12N or later	Ver. 8.25B or later
MX Component	Ver. 3.05F or later	Ver. 3.08J or later

5. Product Specification

5.1 Specifications
 The general specifications of FX2NC-ENET-ADP are same as those of the FX Series PLC except the following items.

Item	Description		
General specifications	Withstand voltage	500V AC for 1 min	Conforms to JEM-1021, between all terminals together and grounding terminal
	Insulation resistance	5 MΩ or more by 500V DC megger	
Power supply specifications	Supply voltage/current	5V DC, 135 mA (supplied from PLC)	
Performance specifications	Baud rate	10Mbps	
	Protocol	CSMA/CD(IEEE802.3)	
	Transmission media	10BASE-T	
	Topology	Star type	
Connector	Communication method	Full duplex	
	To Ethernet	RJ45 connector	
Mass	To ground	3 pins (However, internally short-circuited)	
		0.1 kg (0.22 lbs)	

5.2 Outside dimensions and name of each part

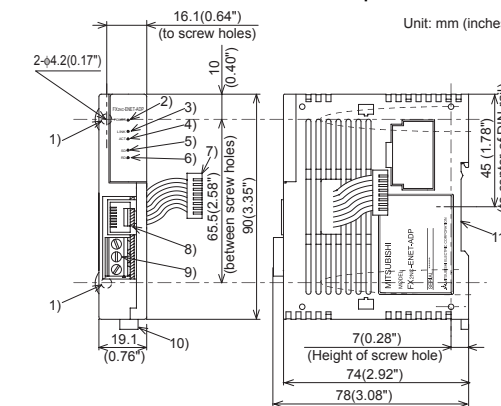

- 1) Mounting hole (2-φ4.2)
Used when FX2NC-ENET-ADP is mounted directly. Not used when the module is mounted on DIN rail.
- 2) POWER LED (green)
Lit while 5V DC power is supplied from the PLC.
- 3) LINK LED (green)
Lit while the HUB is connected by an RJ45 connector and the power is on.
- 4) ACT LED (red)
Lit while transferring data with connected Ethernet.
- 5) SD LED (red)
Lit while sending data to the connected PLC.
- 6) RD LED (red)
Lit while receiving data from the connected PLC.
- 7) Connecting cable
Used to connect the main unit.
- 8) RJ45 connector
Connects the Ethernet cable.

- 9) Terminal block for grounding Internally short-circuited. Applicable cable: AWG 17 to 14 Tightening torque: 0.4 to 0.5 N·m
- 10) DIN rail mounting hook
- 11) DIN rail mounting groove

5.3 Connector pin arrangement

The RJ45 connector in the FX2NC-ENET-ADP has the following pin arrangement.

Pin	Signal name	Direction	Description
1	TD+	Out	+ side of send data
2	TD-	Out	- side of send data
3	RD+	In	+ side of receive data
4	Unused	-	
5	Unused	-	
6	RD-	In	- side of receive data
7	Unused	-	
8	Unused	-	

5.4 Used cable

STP (Shielded twisted pair) cable Category 5(e) or 3

6. Wiring

6.1 Cautions on wiring

Wiring Precaution

- Cut off all phases of external power source before installation or performing wiring work in order to avoid electric shock or damage to the product.

Wiring Precaution

- The grounding terminal in the main unit should be connected to a grounding resistance of 100Ω or less.
- Do not drop cuttings and wire chips into the ventilation slits of the PLC when drilling screw holes or performing wiring work. Otherwise, fire, failure, or malfunction may occur.

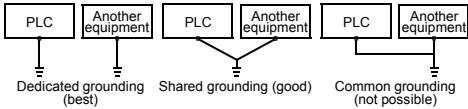

6.2 Wiring example

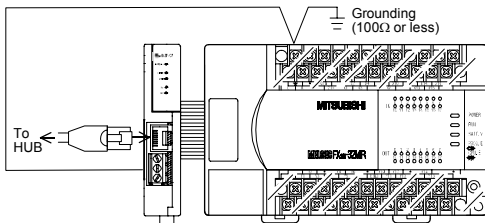

7. Parameter Settings for FX2NC-ENET-ADP

To connect the FX2NC-ENET-ADP to the Ethernet, it is necessary to set the Ethernet parameters, including the Header, IP address, Subnet mask, Gateway address and TCP port number.

Set the Ethernet parameters to the 'D' data registers in the PLC. Immediately after the power is turned on, the FX2NC-ENET-ADP reads the Ethernet parameters stored in the 'D' data registers in the PLC, and configures itself.

7.1 Used devices

[FX1s]

Set the Ethernet parameters to nine data registers from D128 to D136.

Data register	Setting item	Default parameter	Description
D128, D129	Header ^{*1,5}	-	Set H454E4554 ("ENET").
D130, D131	IP address ^{*4}	192.168.0.100	Set the IP address for connecting to Ethernet. ^{*2}
D132, D133	Subnet mask ^{*4}	255.255.255.0	Set the sub-net mask for connecting to Ethernet. ^{*3}
D134, D135	Gateway address ^{*4}	192.168.0.1	Set the gateway address for connecting to Ethernet. ^{*2}
D136	TCP port number	1024	Set the TCP ports within the range from 1024 to 65535.

[FX1N/FX2N/FX2NC]

Set the Ethernet parameters to nine data registers from D1000 to D1008.

If these data registers are used for any other purpose, the Ethernet parameters can be set to nine data registers 'D' starting from D2000, D3000, D4000, D5000, D6000 or D7000.

Data register	Setting item	Default parameter	Description
D□000, D□001	Header ^{*1}	-	Set H454E4554 ("ENET").
D□002, D□003	IP address ^{*4}	192.168.0.100	Set the IP address for connecting to Ethernet. ^{*2}
D□004, D□005	Subnet mask ^{*4}	255.255.255.0	Set the sub-net mask for connecting to Ethernet. ^{*3}
D□006, D□007	Gateway address ^{*4}	192.168.0.1	Set the gateway address for connecting to Ethernet. ^{*2}
D□008	TCP port number	1024	Set the TCP ports within the range from 1024 to 65535.

□: Indicates any number in the range from 1 to 7.

- If "ENET" is not found or the parameters such as IP address, Gateway address, Subnet mask are incorrect, the default parameters are valid.
- If FX2NC-ENET-ADAP cannot read out the specified data register stored in the PLC, the default parameters are used. In such a case, the SD or RD LED is lit. (Refer to 7.4.)

Note

*1 This is the header identifier required when FX2NC-ENET-ADP identifies the Ethernet parameters. Make sure to set H454E4554 ("ENET") to D128/D129 or D□000/D□001.

*2 The first 8 bits used for the IP address and Gateway address must be in the range from 1 to 223. If any number outside this range is used, the RD LED will be lit when the FX2NC-ENET-ADP is turned on and Ethernet communication will not be performed.



Set numbers from 1 to 223.

*3 In the following cases (and as explained in *2) concerning the Subnet mask data, the RD LED will be lit when the FX2NC-ENET-ADP is turned on, an error will occur and Ethernet communication will not be performed. (The following conditions are expressed in binary form.)

- 1) If 1 is set for all bits
- 2) If 0 is set for all bits
- 3) If 1 is set immediately after 0 is set

Example: 111...11000100...

*4 The settings of the IP address, Subnet mask and Gateway address depend on the network environment. For the contents of these parameters, see the network administrator.

*5 The FX2NC-ENET-ADP searches for the header in the order "D1000 → D7000". The values described in lowest data register numbers are set as the Ethernet parameters.

7.2 Parameter setting methods

Set the Ethernet parameters using either of the following methods through serial communication:

- Setting using the PLC program
- Setting using file registers

For each setting example, refer to Section 7.3.

7.3 Parameter setting examples for FX2NC-ENET-ADP

Two examples of setting the Ethernet parameters for the FX2NC-ENET-ADP are shown below:

Example of parameter settings

Data register	Setting item	Parameter	Set data
FX1s	FX1N/FX2N/FX2NC		
D128, D129	D1000, D1001	Header	"ENET" H454E4554
D130, D131	D1002, D1003	IP address	192.168.0.110 HCOA8006E
D132, D133	D1004, D1005	Subnet mask	255.255.255.0 HFFFFFF00
D134, D135	D1006, D1007	Gateway address	192.168.0.1 HCOA80001
D136	D1008	TCP port number	1024 K1024

When the PLC program is used to set the Ethernet parameters

The Ethernet parameters for the FX2NC-ENET-ADP can be set using the program shown below:

Note

In the FX2NC-ENET-ADP, the Ethernet parameters become valid only when the power is turned ON and the setting data is stored in specified data registers.

In either of the following cases, turn off the power of the PLC once, and then turn it on again.

- When a parameter is set for the first time
- When the setting of a parameter is changed during operation

[FX1s]

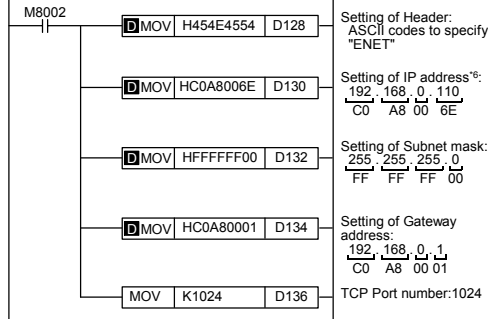

[FX1N/FX2N/FX2NC]

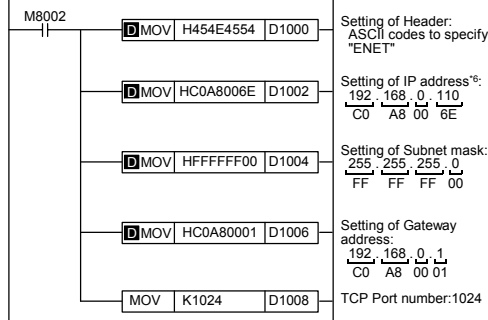

*6 When connecting two or more PLCs to a network, do not use the same IP address twice.

Example: Personal computer (GX Developer) 192.168.0.10
 PLC1 192.168.0.110
 PLC2 192.168.0.111

When file registers are used to set the Ethernet parameters

Select [Parameter] - [PLC parameter] - [Memory capacity] in GX Developer, and set the file register capacity to 1 block or more. Then, right-click [Device memory], add the device memory data, and set the parameters as shown below:

- Settings of D128 to D135 or D1000 to D1007 (32-bit HEX mode)

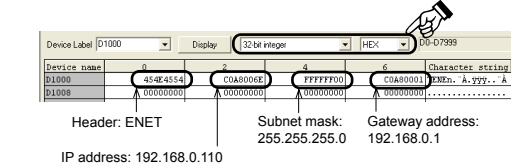

- Settings of D136 or D1008 (16-bit DEC mode)

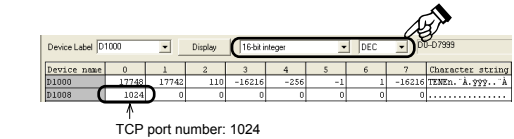

7.4 Check of configuration using SD LED and RD LED

The SD LED and the RD LED can be used to check whether the current configuration is functioning properly or not.

At startup (reset)

After power is turned on, the SD LED and RD LED are lit for 2 seconds, and the FX2NC-ENET-ADP reads the configuration data from the PLC. If the configuration data is read correctly, the SD LED and RD LED turn off. If an error occurs, the SD LED and RD LED indicate the error status as shown below:

	SD LED	RD LED	Description
1)	ON	OFF	The contents of data registers in the PLC cannot be read.
2)	OFF	ON	The header "ENET" cannot be detected. A parameter such as IP address, Gateway address, Subnet mask and TCP port number is invalid.
3)	OFF	OFF	Valid

Note

In case of 1) or 2), the parameters such as IP address, Gateway address, Subnet mask are incorrect and the default parameters are valid.

8. Settings in GX Developer

Set the IP address, the TCP port number and the connection route, etc. on the Transfer setup dialog box, when accessing FX1S, FX1N, FX2N, or FX2NC Series PLC via Ethernet from GX Developer.

Note:

- GX Developer must be Version 8.25B or later.
 - FX Configurator-EN must be installed on the personal computer.
- For details on the installation method of FX Configurator-EN, refer to the FX Configurator-EN Operation Manual.

8.1 Setting method

Select [Online] → [Transfer setup]

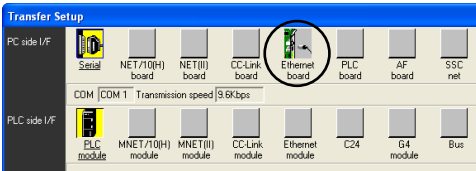

Click "Ethernet board"

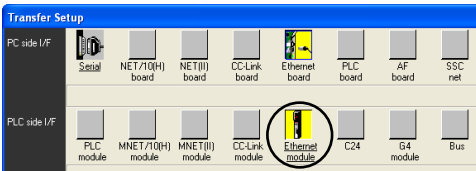

Double-click "Ethernet module"

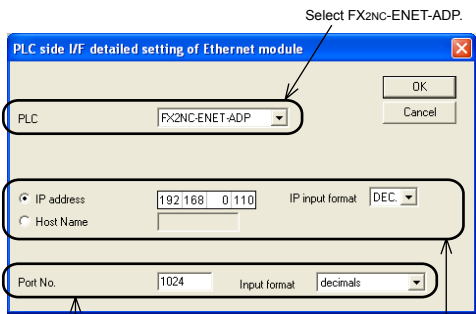

Set the TCP Port Number (Port No.) connection destination as assigned to the FX2NC-ENET-ADP by the sequence program. For details on the TCP port Number setting for the FX2NC-ENET-ADP, refer to Chapter 7.

Set the IP address connection destination as assigned to the FX2NC-ENET-ADP by the sequence program. (When using the Host Name, set the name assigned by the hosts file within 64 characters.) For details on the IP address setting for the FX2NC-ENET-ADP, refer to Chapter 7.

8.2 Operations

In GX Developer, operations such as upload, download, monitoring and test of a program are performed in the same way as with serial communication.

9. Setting in MX Component

Note:

- MX Component must be Version 3.08J or later.
 - FX Configurator-EN must be installed on the personal computer.
- For details on the installation method of FX Configurator-EN, refer to the FX Configurator-EN Operation Manual.

Note: In case of Virtual COM Port (VCP) Driver

If using Virtual COM Port (VCP) Driver, add the Logical station number for Ethernet.

9.1 Setting method

Select [Programs] - [MELSOFT Application] - [MX Component] - [Communication Setup Utility].

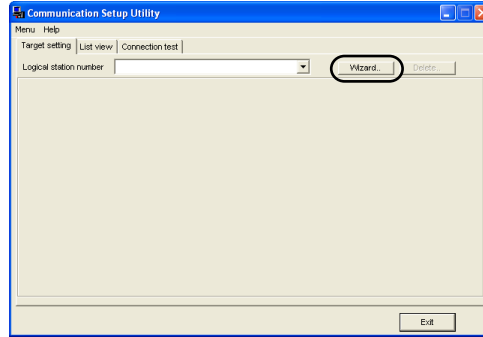

[Wizard]

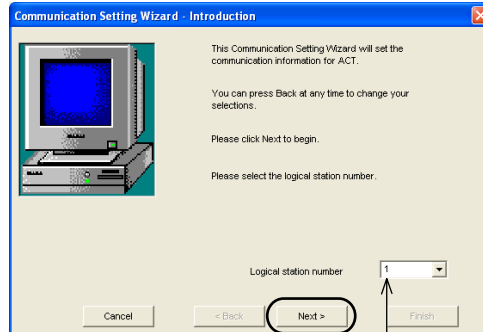

Select the "Logical station number".

[Next]

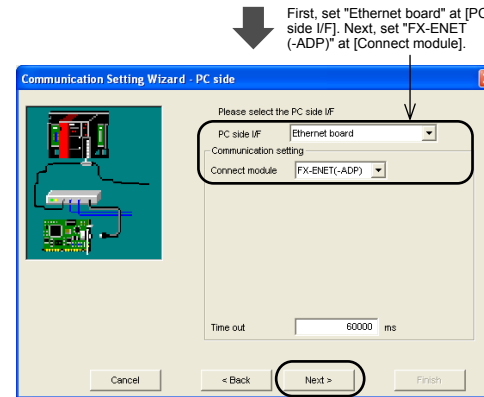

First, set "Ethernet board" at [PC side I/F]. Next, set "FX-ENET (-ADP)" at [Connect module].

[Next]

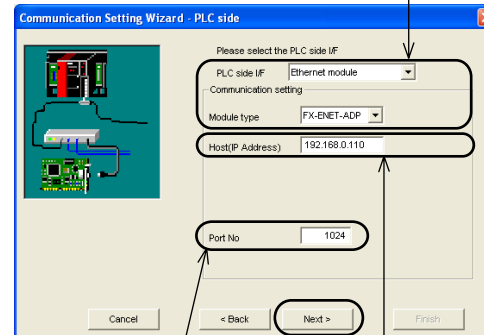

First, set "Ethernet module" at [PLC side I/F]. Next, set "FX-ENET-ADP" at [Module type].

Set the TCP Port Number (Port No) connection destination as assigned to the FX2NC-ENET-ADP by the sequence program. For details on the TCP port Number setting for the FX2NC-ENET-ADP, refer to Chapter 7.

Set the IP address connection destination as assigned to the FX2NC-ENET-ADP by the sequence program. (When using the Host Name, set the name assigned by the hosts file.) For details on the IP address setting for the FX2NC-ENET-ADP, refer to Chapter 7.

[Next]

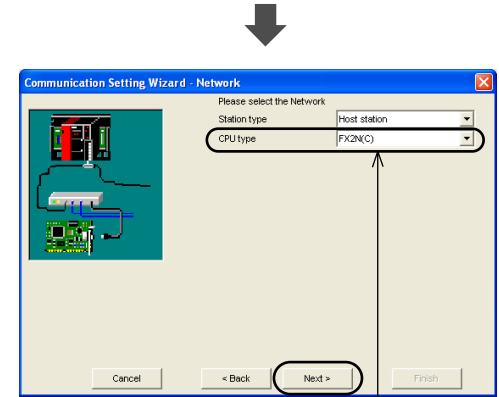

Set FX1S, FX1N, FX2N or FX2nc at [CPU type].

[Next]

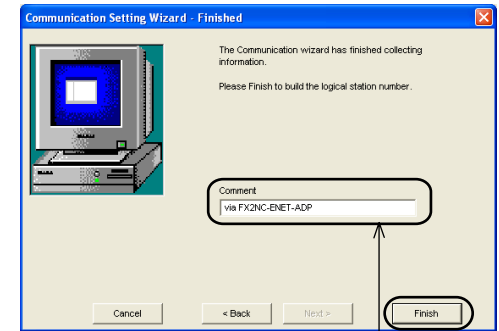

Enter a comment.

[Finish]

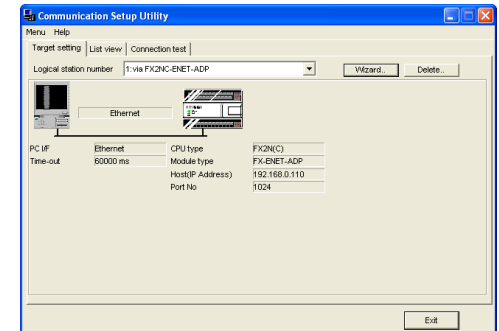

10. Troubleshooting

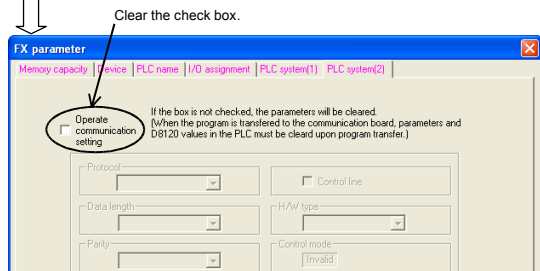
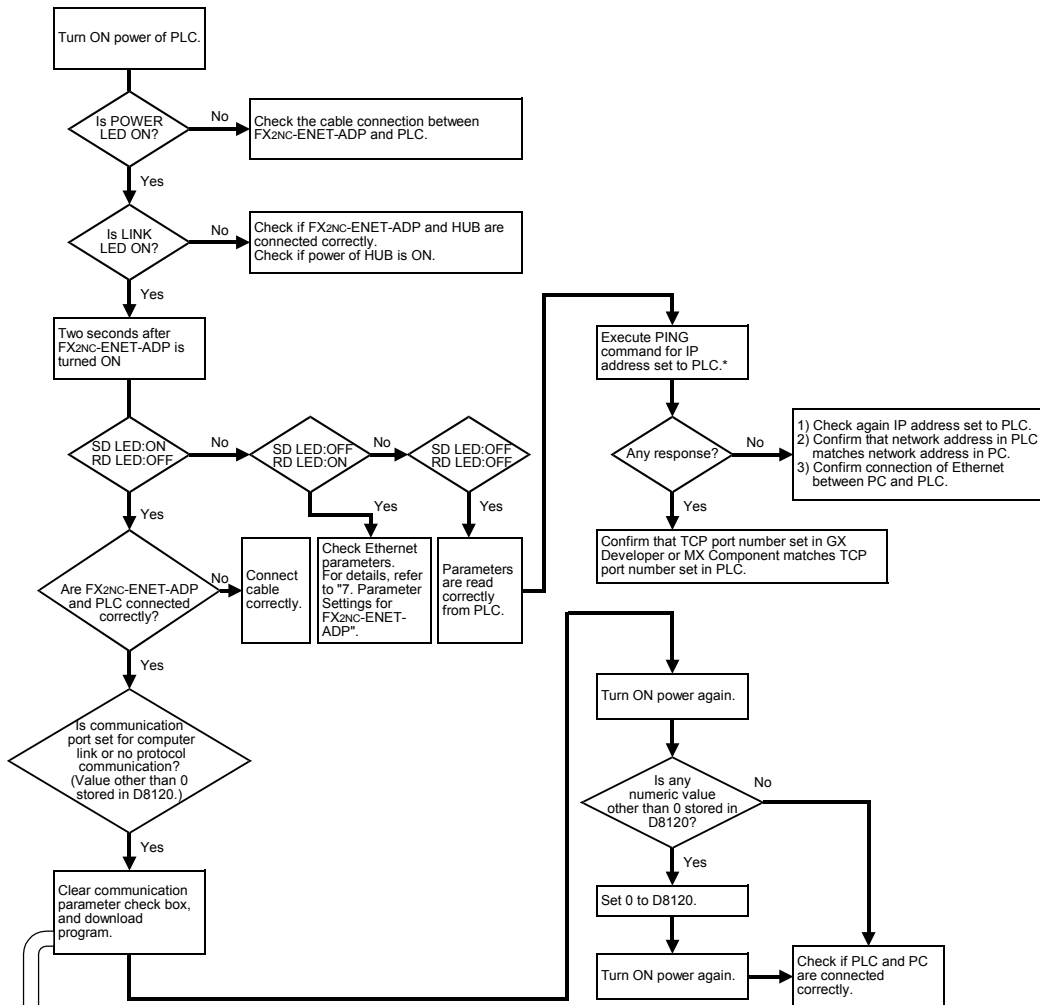

* [Reference]
The PING command confirms confirmation whether the communication between Ethernet devices using the IP address of TCP/IP is possible. Execute the PING command from the personal computer connected to Ethernet, and check whether the FX2nc-ENET-ADP sends a response. Refer to the PING command described below.

Executing the PING command
Open the MS-DOS prompt (command prompt in the Windows2000/XP). In the example parameter settings in Section 7.3, the IP address is set to "192.168.0.110".
PING 192.168.0.110

This manual confers no industrial property rights or any rights of any other kind, nor does it confer any patent licenses. Mitsubishi Electric Corporation cannot be held responsible for any problems involving industrial property rights which may occur as a result of using the contents noted in this manual.

MITSUBISHI PROGRAMMABLE CONTROLLERS MELSEC-F

Changes for the Better

FX2NC-ENET-ADP Ethernet adapter

USER'S MANUAL

Manual Number	JY997D12301
Revision	D
Date	May 2007

This manual contains text, diagrams and explanations which guide the reader in the correct installation and operation of the FX2NC-ENET-ADP Ethernet adapter. It should be read and understood before attempting to use the unit.

If in doubt at any stage of the installation of FX2NC-ENET-ADP, consult a professional electrical technician who is qualified and trained to the local and national standards which apply to the installation site.

If in doubt about the operation or use of the FX2NC-ENET-ADP, please consult the nearest Mitsubishi Electric distributor.

This manual is subject to change without notice.

Microsoft® and Windows® are either registered trademarks or trademarks of Microsoft Corporation in the United States and/or other countries.

The company name and the product name described in this manual are the registered trademarks or trademarks of each company.

Guideline for the safety of the user and protection of the FX2NC-ENET-ADP.
This manual provides usage information for the FX2NC-ENET-ADP Ethernet adapter. The manual has been written to be used by trained and competent personnel.

Notes on the symbols used in this manual
At various times throughout out this manual certain symbols will be used to highlight points of information which are intended to ensure the users personal safety and protect the integrity of equipment. Whenever any of the following symbols are encountered, its associated note must be read and understood. Each of the symbols used will now be listed with a brief description of its meaning.

- Hardware Warnings**
- 1) Indicates that the identified danger **WILL** cause physical and property damage.
 - 2) Indicates that the identified danger could **POSSIBLY** cause physical and property damage.
 - 3) Indicates a point of further interest or further explanation.

DISPOSAL PRECAUTIONS
When disposing of this product, treat it as industrial waste.

INSTALLATION PRECAUTIONS
Use the module in an environment that meets the general specifications contained in this manual. Using this module in an environment outside the range of the general specifications could result in electric shock, fire, erroneous operation, and damage to or deterioration of the product.

Do not disassemble or modify the module. Doing so may cause failure, malfunction, injury, or fire.

TRANSPORTATION AND MAINTENANCE PRECAUTIONS
During transportation avoid any impact as the module is a precision instrument. Doing so could cause trouble in the module.

It is necessary to check the operation of module after transportation, in case of any impact damage.

Note Concerning the CE Marking
The CE marking does not guarantee that an entire mechanical module produced in accordance with the contents of the notification comply with the following standards. Compliance to EMC standards of the entire mechanical module should be checked by the user / manufacturer.

Standards with which this product complies
Type: Programmable Controller (Open Type Equipment)
Models: Products manufactured:
from April 1st, 2004 to April 30th, 2006 are compliant with EN61000-6-4 and EN61131-2:1994+A11:1996+A12:2000 and EN61000-6-2 after May 1st, 2006 are compliant with EN61131-2:2003

Electromagnetic Compatibility Standards (EMC)	Remark
EN61000-6-4:2001 Electromagnetic compatibility -Generic standards - Emission standard for industrial environment	Compliance with all relevant aspects of the standard. (Radiated Emissions and Mains Terminal Voltage Emissions)
EN61131-2:1994/A11:1996/A12:2000 Programmable controllers -Equipment requirements and tests	Compliance with all relevant aspects of the standard. (RF Immunity, Fast transients, ESD and Damped oscillatory wave)
EN61000-6-2:2001 Electromagnetic compatibility -Generic standards Immunity for industrial environments.	Compliance with all relevant aspects of the standard. (RF immunity, Fast transients, ESD, Conducted, Surges, Power magnetic fields, Voltage dips and Voltage interruptions)
EN61131-2: 2003 Programmable controllers -Equipment requirements and tests	Compliance with all relevant aspects of the standard. (Radiated Emissions, Mains Terminal Voltage Emissions, RF immunity, Fast Transients, ESD, Surge, Voltage drops and interruptions, Conducted and Power magnetic fields)

For more details please contact the local Mitsubishi Electric sales site.
- Notes for compliance to the EMC regulation
It is necessary to install the FX2NC-ENET-ADP module in a shielded metal control panel.

1. Associated Manuals

Manual name	Manual No.	Description
FX1S HARDWARE MANUAL	JY992D83901	Describes the hardware of the FX Series PLC such as specifications, wiring, and installation.
FX1N HARDWARE MANUAL	JY992D89301	
FX2N HARDWARE MANUAL	JY992D66301	
FX2NC HARDWARE MANUAL (DSS/DS) (D/UL)	JY992D76401 JY992D87201	
FX PROGRAMMING MANUAL II	JY992D88101	Describes the instructions available in the FX1S/FX1N/FX2N/FX2NC Series PLC.
FX Configurator-EN OPERATION MANUAL	JY997D20501	Describes operation details of FX Configurator-EN Configuration Software.
FX1N-CNV-BD Special Adapter Connection Board	JY992D84701	Describes matters related to the installation of the boards.
FX2N-CNV-BD Special Adapter Connection Board	JY992D63601	

For GX Developer and MX Component, refer to the operation manual respectively.

2. Outline of Product

The FX2NC-ENET-ADP is an Ethernet adapter of 10BASE-T specifications for the FX1S, FX1N, FX2N and FX2NC Series. The FX2NC-ENET-ADP enables the upload, download, monitor, and test of a program from the personal computer (GX Developer or MX Component) via Ethernet.

3. Installation

- Caution**
- Use only in the environments specified under the general specifications in the manual.
 - Do not use the product in environments with excessive or conductive dust, corrosive (including salt breeze, Cl₂, H₂S, SO₂, NO₂, etc.) or flammable gas, oily smoke, moisture or rain, excessive heat, regular impact shocks or excessive vibration, as it may result in electrical shock, fire, malfunction, damage or deterioration of the product.
 - Make sure to shut off the external power before installing or wiring it. Electric shock or serious damage to the product may occur, if the external power is not disconnected.
 - Never drop wire chips or shavings into the ventilation slits when drilling screw holes or performing wiring, as they may cause fire, breakdown, or malfunction.
 - Securely install the FX2NC-ENET-ADP to the designated port. A poor connection may result in malfunction.

3.1 How to Install to FX Series PLC

Installation to FX1S/FX1N/FX2N

- Turn OFF the PLC before beginning any work.
- 1) Remove the panel cover from the top face of the main unit.
 - 2) Take off the resin cover from the left side of the main unit.
 - 3) Install the following board to the port on the main unit.

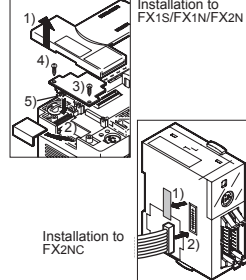

Board name	Corresponding model
FX1N-CNV-BD	FX1S/FX1N
FX2N-CNV-BD	FX2N

- 4) Affix the above board using the supplied M3 screws. Tightening torque: 0.3 to 0.6 N·m
- 5) Connect the built-in cable of the FX2NC-ENET-ADP to the port on the left side of the board.

Installation to FX2NC

Turn OFF the PLC before beginning any work.

- 1) Remove the cover from the special adapter port provided on the left side of the main unit.
- 2) Connect the built-in cable of the FX2NC-ENET-ADP to the special adapter port.

3.2 Installation to a Panel Face

Direct installation to the panel face

Directly attach to the panel face using 2 sets of a screw (M4), a spring washer, and a flat washer in the mounting holes.

Tightening torque: 0.7 to 1.0 N·m
For the pitch and positions of mounting screw holes, refer to the external dimensions.

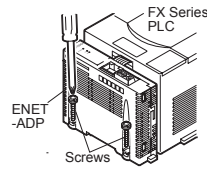

Mounting on DIN rail

Affix the FX2NC-ENET-ADP to the DIN rail, DIN46277 (35 mm (1.37") wide).

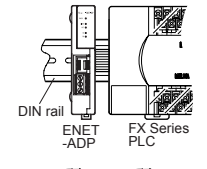

Dismounting from DIN rail

Slightly pull down the DIN rail mounting clip using a tool such as a slotted screwdriver. Pull down the clip further, and the rail will be locked with the clip left open.

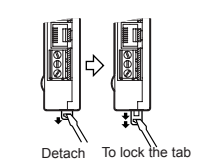

4. System Configuration

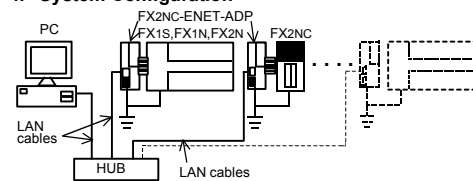

PLC	Ethernet adapter	LAN cable
FX1S/FX1N PLC + FX1N-CNV-BD	FX2NC-ENET-ADP	Twisted pair cable Category 5(e) STP or 3 STP (straight cable)
FX2N PLC + FX2N-CNV-BD		
FX2NC PLC		

Applicable version of GX Developer/MX Component

Software	Applicable Version	With FX Configurator-EN
GX Developer	Ver. 8.12N or later	Ver. 8.25B or later
MX Component	Ver. 3.05F or later	Ver. 3.08J or later

5. Product Specification

5.1 Specifications

The general specifications of FX2NC-ENET-ADP are same as those of the FX Series PLC except the following items.

Item	Description		
General specifications	Withstand voltage	500V AC for 1 min	Conforms to JEM-1021, between all terminals together and grounding terminal
	Insulation resistance	5 MΩ or more by 500V DC megger	
Power supply specifications	Supply voltage/current	5V DC, 135 mA (supplied from PLC)	
	Baud rate	10Mbps	
Performance specifications	Protocol	CSMA/CD(IEEE802.3)	
	Transmission media	10BASE-T	
	Topology	Star type	
	Communication method	Full duplex	
Connector	To Ethernet	RJ45 connector	
	To ground	3 pins (However, internally short-circuited)	
Mass		0.1 kg (0.22 lbs)	

5.2 Outside dimensions and name of each part

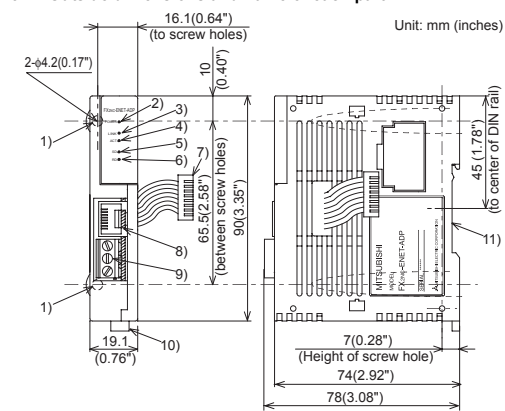

- 1) Mounting hole (2-φ4.2)
Used when FX2NC-ENET-ADP is mounted directly. Not used when the module is mounted on DIN rail.
- 2) POWER LED (green)
Lit while 5V DC power is supplied from the PLC.
- 3) LINK LED (green)
Lit while the HUB is connected by an RJ45 connector and the power is on.
- 4) ACT LED (red)
Lit while transferring data with connected Ethernet.
- 5) SD LED (red)
Lit while sending data to the connected PLC.
- 6) RD LED (red)
Lit while receiving data from the connected PLC.
- 7) Connecting cable
Used to connect the main unit.
- 8) RJ45 connector
Connects the Ethernet cable.

- 9) Terminal block for grounding
Internally short-circuited.
Applicable cable: AWG 17 to 14
Tightening torque: 0.4 to 0.5 N·m
- 10) DIN rail mounting hook
- 11) DIN rail mounting groove

5.3 Connector pin arrangement

The RJ45 connector in the FX2NC-ENET-ADP has the following pin arrangement.

Pin	Signal name	Direction	Description
1	TD+	Out	+ side of send data
2	TD-	Out	- side of send data
3	RD+	In	+ side of receive data
4	Unused	-	
5	Unused	-	
6	RD-	In	- side of receive data
7	Unused	-	
8	Unused	-	

5.4 Used cable

STP (Shielded twisted pair) cable Category 5(e) or 3

6. Wiring

6.1 Cautions on wiring

- Wiring Precaution**
- Cut off all phases of external power source before installation or performing wiring work in order to avoid electric shock or damage to the product.
- Wiring Precaution**
- The grounding terminal in the main unit should be connected to a grounding resistance of 100Ω or less.
 - Do not drop cuttings and wire chips into the ventilation slits of the PLC when drilling screw holes or performing wiring work. Otherwise, fire, failure, or malfunction may occur.

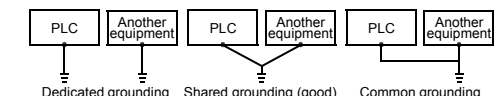

6.2 Wiring example

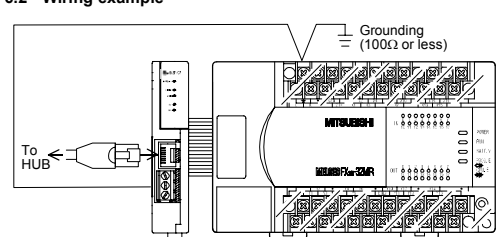

7. Parameter Settings for FX2NC-ENET-ADP

To connect the FX2NC-ENET-ADP to the Ethernet, it is necessary to set the Ethernet parameters, including the Header, IP address, Subnet mask, Gateway address and TCP port number.

Set the Ethernet parameters to the 'D' data registers in the PLC. Immediately after the power is turned on, the FX2NC-ENET-ADP reads the Ethernet parameters stored in the 'D' data registers in the PLC, and configures itself.

7.1 Used devices

[FX1S]
Set the Ethernet parameters to nine data registers from D128 to D136.

Data register	Setting item	Default parameter	Description
D128, D129	Header ¹ *5	-	Set H454E4554 ("ENET").
D130, D131	IP address ⁴	192.168.0.100	Set the IP address for connecting to Ethernet. ²
D132, D133	Subnet mask ⁴	255.255.255.0	Set the sub-net mask for connecting to Ethernet. ³
D134, D135	Gateway address ⁴	192.168.0.1	Set the gateway address for connecting to Ethernet. ²
D136	TCP port number	1024	Set the TCP ports within the range from 1024 to 65535.

[FX1N/FX2N/FX2NC]
Set the Ethernet parameters to nine data registers from D1000 to D1008.

If these data registers are used for any other purpose, the Ethernet parameters can be set to nine data registers 'D' starting from D2000, D3000, D4000, D5000, D6000 or D7000.

Data register	Setting item	Default parameter	Description
D□000, D□001	Header ¹	-	Set H454E4554 ("ENET").
D□002, D□003	IP address ⁴	192.168.0.100	Set the IP address for connecting to Ethernet. ²
D□004, D□005	Subnet mask ⁴	255.255.255.0	Set the sub-net mask for connecting to Ethernet. ³
D□006, D□007	Gateway address ⁴	192.168.0.1	Set the gateway address for connecting to Ethernet. ²
D□008	TCP port number	1024	Set the TCP ports within the range from 1024 to 65535.

□: Indicates any number in the range from 1 to 7.

- If "ENET" is not found or the parameters such as IP address, Gateway address, Subnet mask are incorrect, the default parameters are valid.
- If FX2NC-ENET-ADP cannot read out the specified data register stored in the PLC, the default parameters are used. In such a case, the SD or RD LED is lit. (Refer to 7.4.)

Note

- This is the header identifier required when FX2NC-ENET-ADP identifies the Ethernet parameters. Make sure to set H454E4554 ("ENET") to D128/D129 or D□000/D□001.
- The first 8 bits used for the IP address and Gateway address must be in the range from 1 to 223. If any number outside this range is used, the RD LED will be lit when the FX2NC-ENET-ADP is turned on and Ethernet communication will not be performed.
- In the following cases (and as explained in *2) concerning the Subnet mask data, the RD LED will be lit when the FX2NC-ENET-ADP is turned on, an error will occur and Ethernet communication will not be performed. (The following conditions are expressed in binary form.)
 - 1) If 1 is set for all bits
 - 2) If 0 is set for all bits
 - 3) If 1 is set immediately after 0 is set
Example: 111...1100100...
- The settings of the IP address, Subnet mask and Gateway address depend on the network environment. For the contents of these parameters, see the network administrator.
- The FX2NC-ENET-ADP searches for the header in the order "D1000 → D7000". The values described in lowest data register numbers are set as the Ethernet parameters.

7.2 Parameter setting methods

Set the Ethernet parameters using either of the following methods through serial communication:

- Setting using the PLC program
 - Setting using file registers
- For each setting example, refer to Section 7.3.

7.3 Parameter setting examples for FX2NC-ENET-ADP

Two examples of setting the Ethernet parameters for the FX2NC-ENET-ADP are shown below.

Example of parameter settings

Data register	FX1S	FX1N/FX2N/FX2NC	Setting item	Parameter	Set data
D128, D129	D1000, D1001		Header	"ENET"	H454E4554
D130, D131	D1002, D1003		IP address	192.168.0.110	HC0A8006E
D132, D133	D1004, D1005		Subnet mask	255.255.255.0	HFFFFFF00
D134, D135	D1006, D1007		Gateway address	192.168.0.1	HC0A80001
D136	D1008		TCP port number	1024	K1024

When the PLC program is used to set the Ethernet parameters

The Ethernet parameters for the FX2NC-ENET-ADP can be set using the program shown below:

Note
In the FX2NC-ENET-ADP, the Ethernet parameters become valid only when the power is turned ON and the setting data is stored in specified data registers.
In either of the following cases, turn off the power of the PLC once, and then turn it on again.

- When a parameter is set for the first time
- When the setting of a parameter is changed during operation

[FX1S]

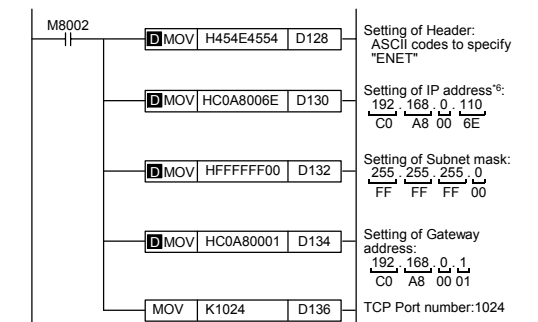

[FX1N/FX2N/FX2NC]

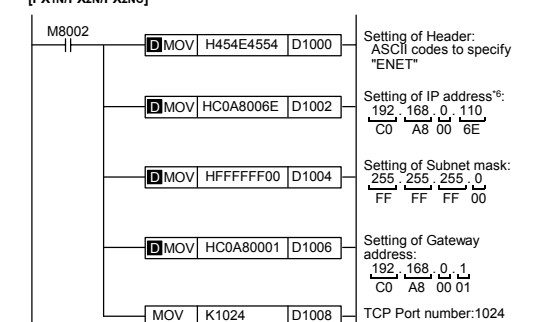

- When connecting two or more PLCs to a network, do not use the same IP address twice.
Example: Personal computer (GX Developer) 192.168.0.10
PLC1 192.168.0.110
PLC2 192.168.0.111

When file registers are used to set the Ethernet parameters

Select [Parameter] - [PLC parameter] - [Memory capacity] in GX Developer, and set the file register capacity to 1 block or more.
Then, right-click [Device memory], add the device memory data, and set the parameters as shown below:

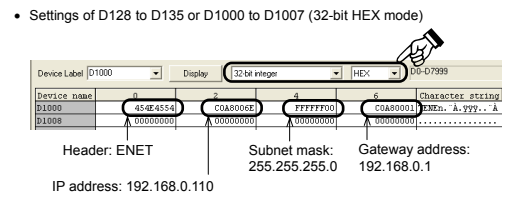

- Settings of D136 or D1008 (16-bit DEC mode)

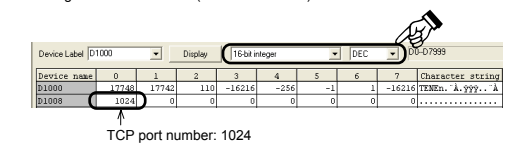

7.4 Check of configuration using SD LED and RD LED

The SD LED and the RD LED can be used to check whether the current configuration is functioning properly or not.

At startup (reset)

After power is turned on, the SD LED and RD LED are lit for 2 seconds, and the FX2NC-ENET-ADP reads the configuration data from the PLC.
If the configuration data is read correctly, the SD LED and RD LED turn off. If an error occurs, the SD LED and RD LED indicate the error status as shown below:

SD LED	RD LED	Description
1) ON	OFF	The contents of data registers in the PLC cannot be read.
2) OFF	ON	The header "ENET" cannot be detected. A parameter such as IP address, Gateway address, Subnet mask and TCP port number is invalid.
3) OFF	OFF	Valid

Note

In case of 1) or 2), the parameters such as IP address, Gateway address, Subnet mask are incorrect and the default parameters are valid.

8. Settings in GX Developer

Set the IP address, the TCP port number and the connection route, etc. on the Transfer setup dialog box, when accessing FX1S, FX1N, FX2N, or FX2NC Series PLC via Ethernet from GX Developer.

Note:

- GX Developer must be Version 8.25B or later.
- FX Configurator-EN must be installed on the personal computer.

8.1 Setting method

Select [Online] → [Transfer setup]

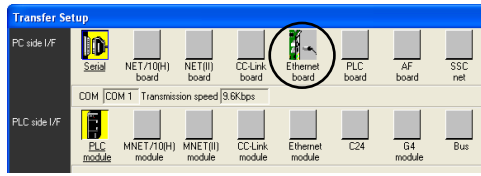

Click "Ethernet board"

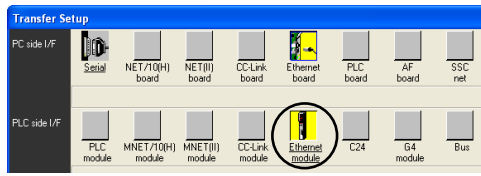

Double-click "Ethernet module"

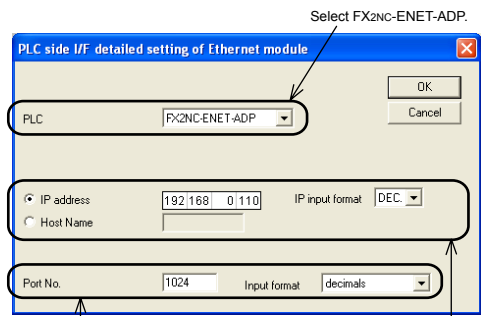

Select FX2NC-ENET-ADP.

Set the TCP Port Number (Port No.) connection destination as assigned to the FX2NC-ENET-ADP by the sequence program. For details on the TCP port Number setting for the FX2NC-ENET-ADP, refer to Chapter 7.

Set the IP address connection destination as assigned to the FX2NC-ENET-ADP by the sequence program. (When using the Host Name, set the name assigned by the hosts file within 64 characters.) For details on the IP address setting for the FX2NC-ENET-ADP, refer to Chapter 7.

8.2 Operations

In GX Developer, operations such as upload, download, monitoring and test of a program are performed in the same way as with serial communication.

9. Setting in MX Component

Note:

- MX Component must be Version 3.08J or later.
- FX Configurator-EN must be installed on the personal computer.

Note: In case of Virtual COM Port (VCP) Driver

If using Virtual COM Port (VCP) Driver, add the Logical station number for Ethernet.

9.1 Setting method

Select [Programs] - [MELSOFT Application] - [MX Component] - [Communication Setup Utility].

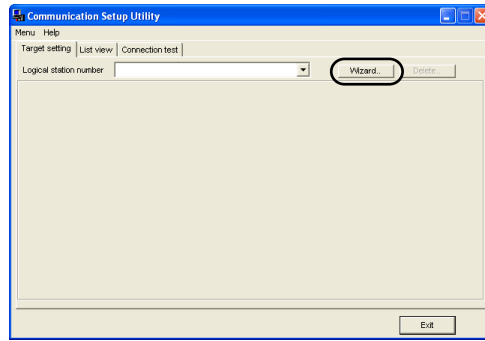

[Wizard]

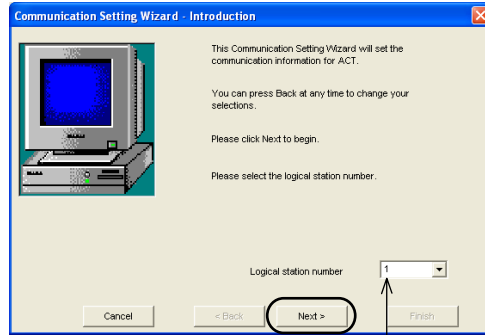

[Next]

Select the "Logical station number".

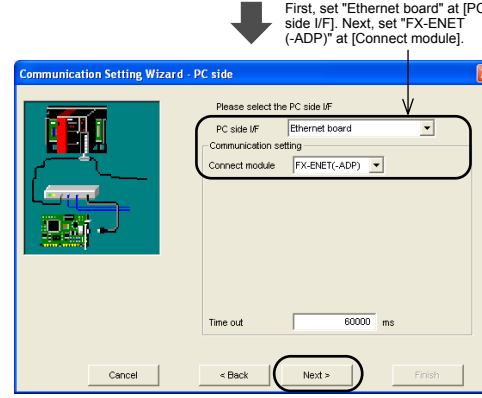

First, set "Ethernet board" at [PC side I/F]. Next, set "FX-ENET(-ADP)" at [Connect module].

[Next]

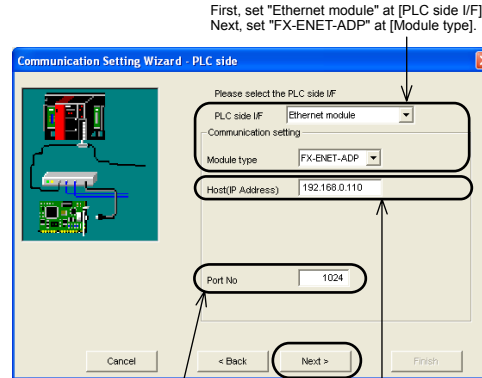

First, set "Ethernet module" at [PLC side I/F]. Next, set "FX-ENET-ADP" at [Module type].

Set the TCP Port Number (Port No) connection destination as assigned to the FX2NC-ENET-ADP by the sequence program. For details on the TCP port Number setting for the FX2NC-ENET-ADP, refer to Chapter 7.

Set the IP address connection destination as assigned to the FX2NC-ENET-ADP by the sequence program. (When using the Host Name, set the name assigned by the hosts file.) For details on the IP address setting for the FX2NC-ENET-ADP, refer to Chapter 7.

[Next]

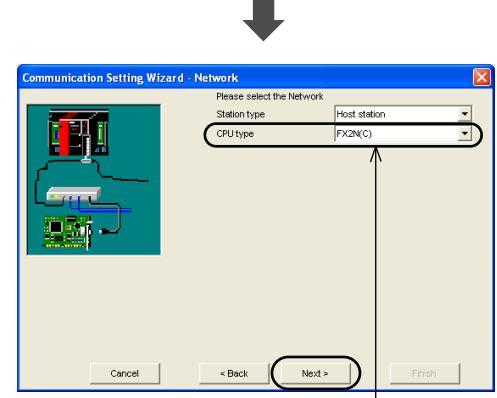

[Next]

Set FX1S, FX1N, FX2N or FX2NC at [CPU type].

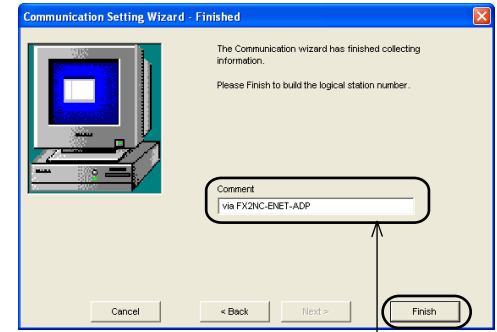

[Finish]

Enter a comment.

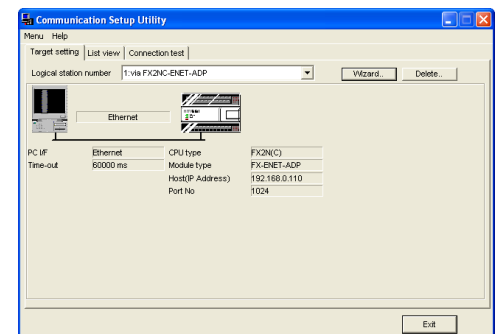

10. Troubleshooting

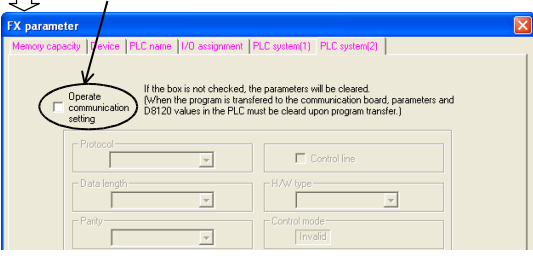
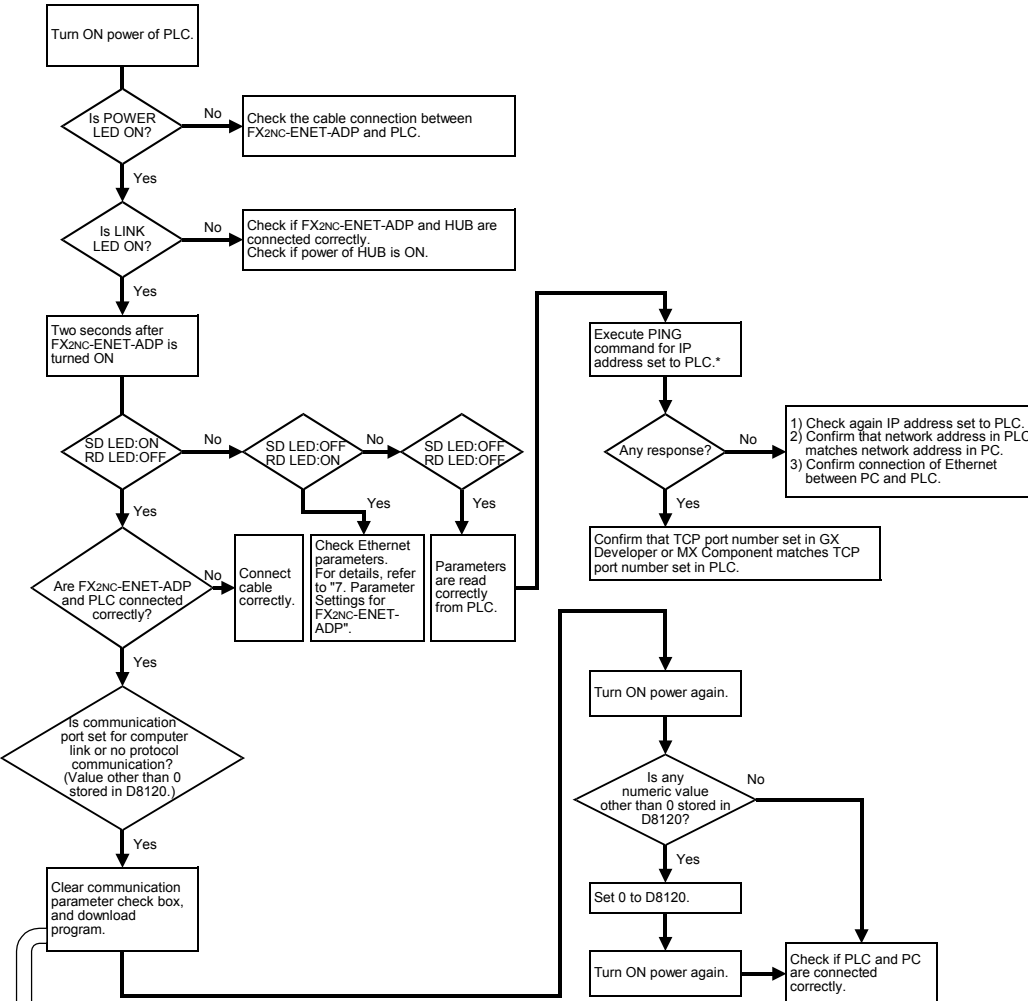

* [Reference]
The PING command confirms confirmation whether the communication between Ethernet devices using the IP address of TCP/IP is possible. Execute the PING command from the personal computer connected to Ethernet, and check whether the FX2NC-ENET-ADP sends a response. Refer to the PING command described below.

Executing the PING command
Open the MS-DOS prompt (command prompt in the Windows2000/XP). In the example parameter settings in Section 7.3, the IP address is set to "192.168.0.110".
PING 192.168.0.110

This manual confers no industrial property rights or any rights of any other kind, nor does it confer any patent licenses. Mitsubishi Electric Corporation cannot be held responsible for any problems involving industrial property rights which may occur as a result of using the contents noted in this manual.