

FX_{2N}

FX_{2N}-2AD SPECIAL FUNCTIONBLOCK

USER'S GUIDE

JY992D74701D

This manual contains text, diagrams and explanations which will guide the reader in the correct installation and operation of the FX_{2N}-2AD special function block and should be read and understood before attempting to install or use the unit.

Further information can be found in the FX SERIES PROGRAMMING MANUAL(II), FX_{0N}/FX_{1N}/FX_{2N}/FX_{2NC} SERIES HARDWARE MANUAL of each PLC.

1. Introduction

The FX_{2N}-2AD type analog input block (hereafter referred to as the FX_{2N}-2AD) is used to convert the analog input of two points (voltage and current input) into a digital value of 12 bits, and to forward the values to the Programmable Controller (hereafter referred to as a PLC).

FX_{2N}-2AD can be connected to the FX_{0N}, FX_{1N}, FX_{2N}, and the FX_{2NC} series Programmable Controllers.

- 1) The analog input is selected from the voltage or current input by the method of connecting wires. At this time, assume the setting to be two channels common analog input (voltage or current input).
- 2) The analog to digital conversion characteristics can be adjusted.
- 3) The block occupies 8 I/O points which can be allocated from either inputs or outputs.
- 4) The data transfer with the PLC uses the FROM/TO instructions.

2. External Dimensions and Parts

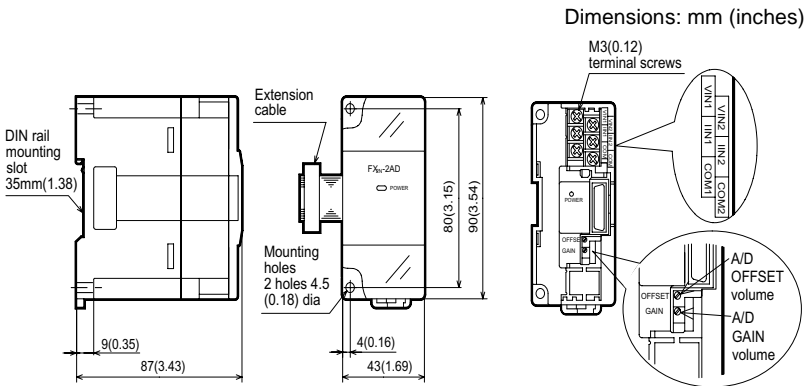

Mass (Weight): 0.2kg (0.44lbs)

Accessories: Special Function block number label

3. Wiring

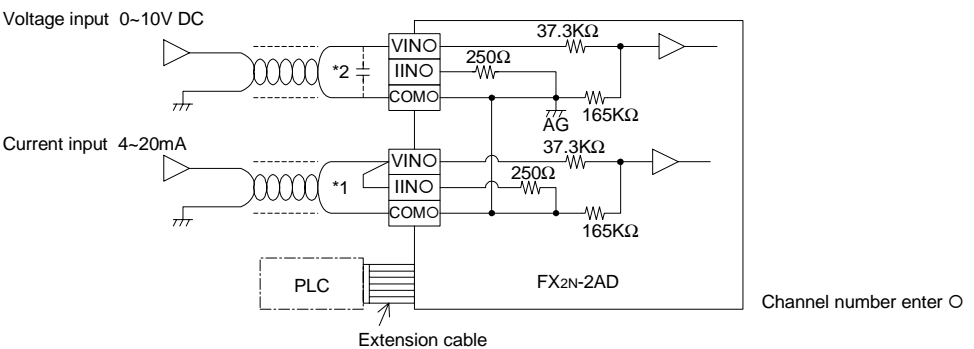

*1 The FX_{2N}-2AD cannot have 1 channel as an analog voltage input and one channel as current input because both channels use the same offset and gain values. For current input please short circuit VIN and IIN as shown in the diagram.

*2 Connect a 0.1 to 0.47 μF 25V DC capacitor with the position of *2 when there is voltage ripple in the voltage input or there will be a lot of noise.

4. Connection with Programmable controller

- 1) The FX2N-2AD and main unit are connected by a cable on the right of the main unit.
- 2) Up to 4 FX2N-2AD units can connect to the FX0N series PLC, up to 5 for FX1N, up to 8 for FX2N or, up to 4 for the FX2NC series PLC, all with powered extension units.
However the following limitation exists when the undermentioned special function blocks are connected.
 - FX2N: Main unit and powered extension units of 32 points I/O or less. Consumption current available for undermentioned special function blocks $\leq 190\text{mA}$
 - FX2N: Main unit and powered extension units of I/O 48 points or more. Consumption current available for undermentioned special function blocks $\leq 300\text{mA}$
 - FX2NC: Up to 4 undermentioned special function blocks can be connected regardless of the system I/O.
 - FX0N/1N: Main unit and powered extension units. Up to 2 undermentioned special function blocks can be connected regardless of the system I/O.

	FX2N-2AD	FX2N-2DA	FX0N-3A
Consumption current of 24V DC for one unit	50mA	85mA	90mA

The consumption current of the above units is to be subtracted from the service power supply of the host PLC.

- 3) The blocks occupies 8 points. (The 8 points can be allocated from either inputs or outputs).
- 4) FX2N-2AD consumes 5V DC by 20mA.
The total 5V consumption of all special function blocks connected to an FX2N, FX2NC main unit or FX2N extension unit must not exceed the 5V source capacity of the system.

5. Specifications

5.1 Environmental specification

Item	Content
Dielectric withstand voltage	500V AC 1min(Between all terminals and case)

Environmental specifications other than the above-mentioned are the same as the main unit of the Programmable controller. (Refer to the Hardware manual of the Programmable controller)

5.2 Power supply specification and others

Item	Content
Analog circuits	24V DC $\pm 10\%$ 50mA (Internal power supplied from the main unit)
Digital circuits	5V DC 20mA (Internal power supplied from the main unit)
Isolation	Photo-coupler isolation between analog and digital circuits. No isolation between analog channels.
Number of occupied I/O points	The blocks occupies either 8 input or output points (can be either inputs or outputs)

5.3 Defining gain and offset

Item	Voltage input	Current input
Range of analog input	At shipping, the unit is adjusted to a digital range of 0 to 4000 for an analog voltage input of 0 to 10V DC. When using an FX2N-2AD for current or differing voltage inputs except 0 to 10V DC, it is necessary to adjust the offset and gain. 0 to 10V DC, 0 to 5V DC (input resistance 200K Ω) Warning-this unit may be damaged by an input voltage in excess of -0.5V, +15V DC	4 to 20mA (input resistance 250 Ω) Warning-this unit may be damaged by an input current in excess of -2mA, +60mA
Digital output	12bit	
Resolution	2.5mV:10V/4000(At shipment) Change depending on the input characteristic.	4 μ A: (20-4)A/4000 Change depending on the input characteristic.
Integrated accuracy	$\pm 0.1\text{V}$	$\pm 0.16\text{mA}$
Processing time	2.5ms/1 channel (synchronized to the sequence program)	
Input characteristics	<p>Analog value :0 to 10V Digital value :0 to 4000 (At shipment)</p>	<p>Analog value :0 to 20mA Digital value :0 to 4000</p>
The input characteristic is the same for each channel.		

6. Allocation of buffer memory (BFM)

6.1 Buffer memory

BFM number	b15 to b8	b7 to b4	b3	b2	b1	b0
#0	Reserved	Current value of input data (lower 8bit data)				
#1	Reserved		Current value of input data (higher 4bit data)			
#2 to 16	Reserved					
#17	Reserved			Analog to digital conversion beginning		Analog to digital conversion channel
#18 or more	Reserved					

BFM#0 :The current value of the input data for the channel specified with BFM#17 (lower 8bit data) is stored.The current value data is stored by binary.

BFM#1:The current value of the input data (higher 4bit data) is stored. The current value data is stored by binary.

BFM#17:b0...Channel (CH1,CH2) which does the analog to digital conversion is specified.

b0=0...CH1

b0=1...CH2

b1...0→1 The A/D conversion process is started.

Write/read data to the above-mentioned buffer memory according to the programming example of "8.Program example".

7. Adjustment of offset and gain

7.1 Change in input characteristic

At shipment, 0 to 10V range is selected for 0 to 10V DC input.

When using an FX2N-2AD for current or differing voltage inputs except 0 to 10V DC, it is necessary to adjust the offset and gain.

The module does not allow different input characteristics for two channels.

Set analog values within the range specified in the table below when changing the input characteristic.

Range of input characteristic

	Voltage input	Current input
Analog value when digital value is 0	0 to 1V	0 to 4mA
Analog value when digital value is 4000	5 to 10V	20mA

Resolution changes depending on the set value when the input characteristic changes accordingly.

Example: Resolution becomes $(5 - 0V)/4000 = 1.25mV$ at voltage input 0 to 5V/0 to 4000.

Integrated accuracy does not change. (Voltage input: $\pm 0.1V$, Current input: $\pm 0.16mA$)

The adjustment of the offset and gain values sets a digital equivalent to the analogue data.

(The "POT" requires 18 revolutions to move between MIN and MAX setting.)

Voltage input

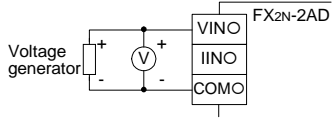

Current input

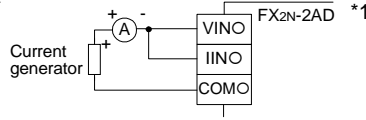

Volume

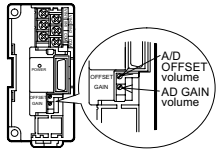

*1 The digital value increases if the volume is turned clockwise.

(FX2N-4DA and FX2N-2DA can be used instead of the voltage and current generator)

7.1.1 Adjustment of gain

The gain value can be set to an arbitrary digital value.

However, using the maximum 12bit resolution provides the user with a digital range of 0 to 4000.

Voltage input characteristic(0 to 10V)
At shipment

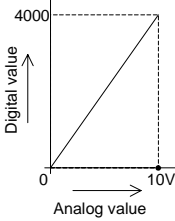

Voltage input characteristic(0 to 5V)

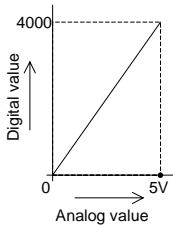

Current input characteristic(4 to 20mA)

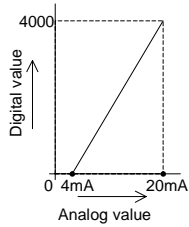

7.1.2 Adjustment of offset

The offset value can be set to an arbitrary digital value. However, it is advisable to set the analog value when the digital value is set as following.

Voltage input characteristic(0 to 10V)
At shipment

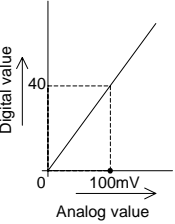

Voltage input characteristic(0 to 5V)

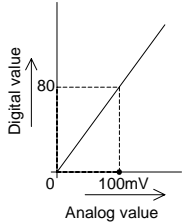

Current input characteristic(4 to 20mA)

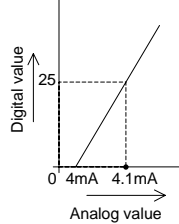

For instance, when a digital range of 0 to 4000 is used with the analog range of 0 to 10V, a digital value of 40 is equal to an analog input of 100mV. ($40 \times 10V/4000$ digital points)

- 1) The offset and gain adjustments for CH1 and CH2 are accomplished at the same time. When the offset and gain values of one channel are adjusted, the other channel is automatically adjusted.
- 2) Repeat the offset and gain adjustment alternately until a stable value is reached.
- 3) Each channel is common to the analog input circuit. However, check each channel individually for maximum accuracy.
- 4) Adjust offset / gain by using subsection 8-3 "Example of programming making average value data" when a digital value is not steady.
- 5) Adjust the gain before the offset.

8. Program example

The following program examples (8.1 and 8.3) are formula circuits.

The device numbers that have been underlined can be assigned by the user during programming.

8.1 Example of programming analog input

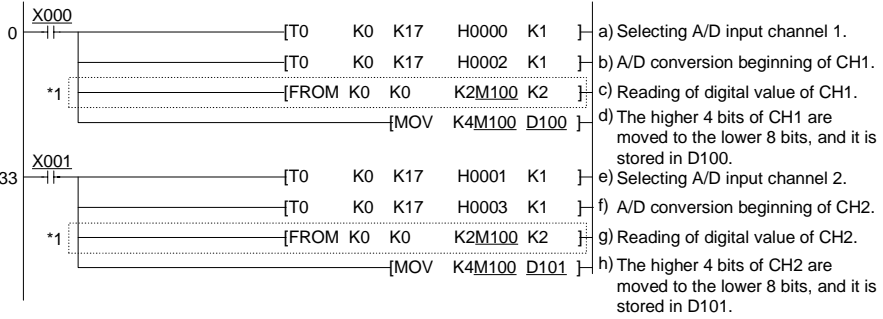

Analog to digital conversion execution input of CH1:X000

Analog to digital conversion execution input of CH2:X001

At the same time X000 and X001 can be turned ON.

A/D input data CH1 :D100 (Replace with auxiliary relay M100 to M115. Assign these numbers only once)

A/D input data CH2 :D101 (Replace with auxiliary relay M100 to M115. Assign these numbers only once)

Processing time: 2.5ms / 1 channel

(Time from turning on X000 and X001 to storage of analog to digital conversion value in data register of main unit.)

*1 Change the circuit of "**1" as follows when using an FX0N PLC



8.2 Connection to FX2N (V3.00 or later) or FX2NC (V3.00 or later) Series PLC

Please use FNC 176 (RD3A).

Refer to FX Series Programming Manual II.

8.3 Example of programming making average value data

Add the undermentioned program after "8.1 Example of programming analog input" and use the average value data when you can not read a stable digital value.

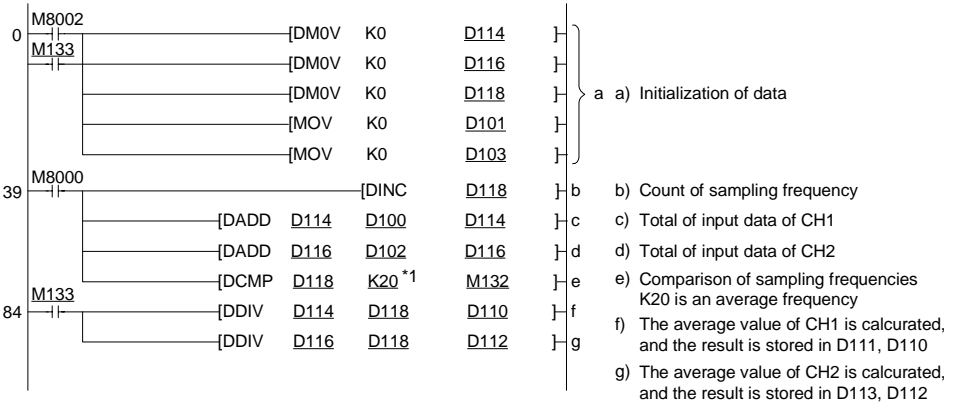

A/D input data of CH1 :D100

A/D input data of CH2 :D102

Sampling frequency :D118

Agreement flag of sampling frequency and average frequency :M133

Average value of CH1 :D111, D110

Average value of CH2 :D113, D112

*1 The above program example has an average sampling frequency of 20. Make the average frequency within the range of 2 to 262143.

9. Notes in drive

- 1) Confirm whether the input wiring of FX2N-2AD and the connection of the extension cable is correctly done.
- 2) Confirm whether the "4. Connection with programmable controller" condition is satisfied.
- 3) When shipped from the factory, the input characteristic is adjusted to 0 to 10V DC.
If a different input characteristic is desired, please adjust as required.
When the input characteristic is adjusted, the input characteristics of CH1 and CH2 are changed.
- 4) The coexistence use for the current and voltage input cannot be done with two channels.

10. Error check

Confirm the following items when it seems that the FX2N-2AD does not operate normally.

- 1) Confirm the state of POWER LED.
Lit :The extension cable is correctly connected.
Turn off or blinks :Confirm the proper connection of the extension cable.
- 2) Confirm the external wiring per section "3. Wiring".
- 3) Confirm whether the load resistance of the connected equipment corresponds to the specification of the FX2N-2AD.
- 4) Confirm the Voltage and Current input values with a voltage and current generator. Confirm the analog to digital conversion from the input characteristic.
- 5) Readjust the offset and gain by "7. Adjustment of offset and gain" when the analog to digital conversion is not suitable for the input characteristic.
The input characteristic when shipped from the factory is 0 to 10V DC.

Guidelines for the safety of the user and protection of the FX2N-2AD SPECIAL FUNCTION BLOCK

- This manual has been written to be used by trained and competent personnel. This is defined by the European directives for machinery, low voltage and EMC.
- If in doubt at any stage during the installation of the FX2N-2AD always consult a professional electrical engineer who is qualified and trained to the local and national standards. If in doubt about the operation or use of the FX2N-2AD please consult the nearest Mitsubishi Electric distributor.
- Under no circumstances will Mitsubishi Electric be liable or responsible for any consequential damage that may arise as a result of the installation or use of this equipment.
- All examples and diagrams shown in this manual are intended only as an aid to understanding the text, not to guarantee operation. Mitsubishi Electric will accept no responsibility for actual use of the product based on these illustrative examples.
- Owing to the very great variety in possible application of this equipment, you must satisfy yourself as to its suitability for your specific application.

Manual number : JY992D74701

Manual revision : D

Date : SEPTEMBER 2002



HEAD OFFICE : MITSUBISHI DENKI BLDG MARUNOUTI TOKYO 100-8310 TELEX : J24532 CABLE MELCO TOKYO
HIMEJI WORKS : 840, CHIYODA CHO, HIMEJI, JAPAN

FX_{2N}

FX_{2N}-2AD SPECIAL FUNCTIONBLOCK

USER'S GUIDE

JY992D74701D

This manual contains text, diagrams and explanations which will guide the reader in the correct installation and operation of the FX_{2N}-2AD special function block and should be read and understood before attempting to install or use the unit.

Further information can be found in the FX SERIES PROGRAMMING MANUAL(II), FX_{0N}/FX_{1N}/FX_{2N}/FX_{2NC} SERIES HARDWARE MANUAL of each PLC.

1. Introduction

The FX_{2N}-2AD type analog input block (hereafter referred to as the FX_{2N}-2AD) is used to convert the analog input of two points (voltage and current input) into a digital value of 12 bits, and to forward the values to the Programmable Controller (hereafter referred to as a PLC).

FX_{2N}-2AD can be connected to the FX_{0N}, FX_{1N}, FX_{2N}, and the FX_{2NC} series Programmable Controllers.

- 1) The analog input is selected from the voltage or current input by the method of connecting wires. At this time, assume the setting to be two channels common analog input (voltage or current input).
- 2) The analog to digital conversion characteristics can be adjusted.
- 3) The block occupies 8 I/O points which can be allocated from either inputs or outputs.
- 4) The data transfer with the PLC uses the FROM/TO instructions.

2. External Dimensions and Parts

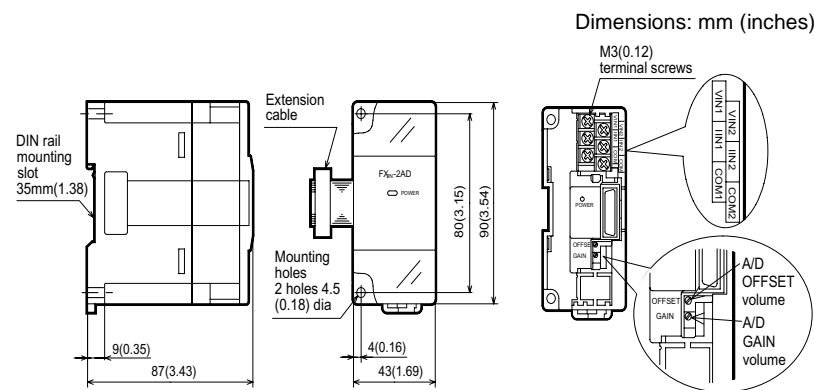

Mass (Weight): 0.2kg (0.44lbs)
Accessories: Special Function block number label

3. Wiring

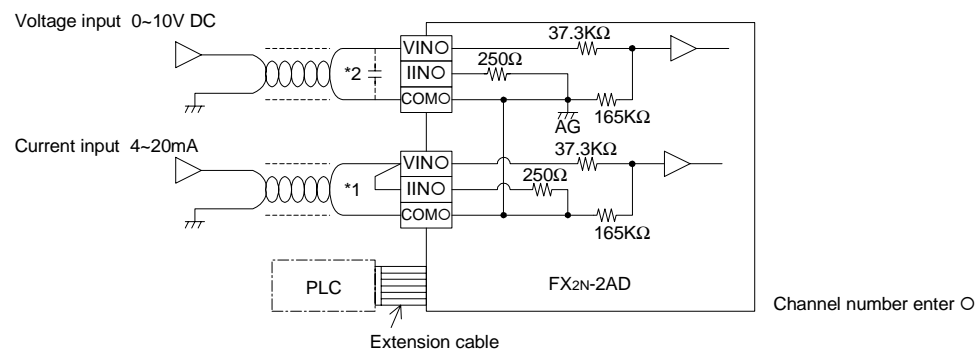

*1 The FX_{2N}-2AD cannot have 1 channel as an analog voltage input and one channel as current input because both channels use the same offset and gain values. For current input please short circuit VIN and IIN as shown in the diagram.

*2 Connect a 0.1 to 0.47 μF 25V DC capacitor with the position of *2 when there is voltage ripple in the voltage input or there will be a lot of noise.

4. Connection with Programmable controller

- 1) The FX_{2N}-2AD and main unit are connected by a cable on the right of the main unit.
- 2) Up to 4 FX_{2N}-2AD units can connect to the FX_{0N} series PLC, up to 5 for FX_{1N}, up to 8 for FX_{2N} or, up to 4 for the FX_{2NC} series PLC, all with powered extension units. However the following limitation exists when the undermentioned special function blocks are connected.
FX_{2N}: Main unit and powered extension units of 32 points I/O or less. Consumption current available for undermentioned special function blocks ≤ 190mA
FX_{2N}: Main unit and powered extension units of I/O 48 points or more. Consumption current available for undermentioned special function blocks ≤ 300mA
FX_{2NC}: Up to 4 undermentioned special function blocks can be connected regardless of the system I/O.
FX_{0N/1N}: Main unit and powered extension units. Up to 2 undermentioned special function blocks can be connected regardless of the system I/O.

	FX _{2N} -2AD	FX _{2N} -2DA	FX _{0N} -3A
Consumption current of 24V DC for one unit	50mA	85mA	90mA

The consumption current of the above units is to be subtracted from the service power supply of the host PLC.

- 3) The blocks occupies 8 points. (The 8 points can be allocated from either inputs or outputs).
- 4) FX_{2N}-2AD consumes 5V DC by 20mA. The total 5V consumption of all special function blocks connected to an FX_{2N}, FX_{2NC} main unit or FX_{2N} extension unit must not exceed the 5V source capacity of the system.

5. Specifications

5.1 Environmental specification

Item	Content
Dielectric withstand voltage	500V AC 1min(Between all terminals and case)

Environmental specifications other than the above-mentioned are the same as the main unit of the Programmable controller. (Refer to the Hardware manual of the Programmable controller)

5.2 Power supply specification and others

Item	Content
Analog circuits	24V DC ±10% 50mA (Internal power supplied from the main unit)
Digital circuits	5V DC 20mA (Internal power supplied from the main unit)
Isolation	Photo-coupler isolation between analog and digital circuits. No isolation between analog channels.
Number of occupied I/O points	The blocks occupies either 8 input or output points (can be either inputs or outputs)

5.3 Defining gain and offset

Item	Voltage input	Current input
Range of analog input	At shipping, the unit is adjusted to a digital range of 0 to 4000 for an analog voltage input of 0 to 10V DC. When using an FX _{2N} -2AD for current or differing voltage inputs except 0 to 10V DC, it is necessary to adjust the offset and gain. 0 to 10V DC, 0 to 5V DC (input resistance 200KΩ) Warning-this unit may be damaged by an input voltage in excess of -0.5V, +15V DC	4 to 20mA (input resistance 250Ω) Warning-this unit may be damaged by an input current in excess of -2mA, +60mA
Digital output	12bit	
Resolution	2.5mV:10V/4000(At shipment) Change depending on the input characteristic.	4μA: (20-4)A/4000 Change depending on the input characteristic.
Integrated accuracy	±0.1V	±0.16mA
Processing time	2.5ms/1 channel (synchronized to the sequence program)	
Input characteristics	<p>Analog value : 0 to 10V Digital value : 0 to 4000 (At shipment)</p>	<p>Analog value : 0 to 20mA Digital value : 0 to 4000</p>
The input characteristic is the same for each channel.		

6. Allocation of buffer memory (BFM)

6.1 Buffer memory

BFM number	b15 to b8	b7 to b4	b3	b2	b1	b0
#0	Reserved	Current value of input data (lower 8bit data)				
#1	Reserved		Current value of input data (higher 4bit data)			
#2 to 16	Reserved					
#17	Reserved			Analog to digital conversion beginning		Analog to digital conversion channel
#18 or more	Reserved					

BFM#0 :The current value of the input data for the channel specified with BFM#17 (lower 8bit data) is stored.The current value data is stored by binary.

BFM#1:The current value of the input data (higher 4bit data) is stored. The current value data is stored by binary.

BFM#17:b0...Channel (CH1,CH2) which does the analog to digital conversion is specified.

b0=0...CH1
b0=1...CH2

b1...0→1 The A/D conversion process is started.

Write/read data to the above-mentioned buffer memory according to the programming example of "8.Program example".

7. Adjustment of offset and gain

7.1 Change in input characteristic

At shipment, 0 to 4000 range is selected for 0 to 10V DC input. When using an FX2N-2AD for current or differing voltage inputs except 0 to 10V DC, it is necessary to adjust the offset and gain. The module does not allow different input characteristics for two channels. Set analog values within the range specified in the table below when changing the input characteristic.

Range of input characteristic

	Voltage input	Current input
Analog value when digital value is 0	0 to 1V	0 to 4mA
Analog value when digital value is 4000	5 to 10V	20mA

Resolution changes depending on the set value when the input characteristic changes accordingly. Example: Resolution becomes $(5 - 0V)/4000 = 1.25mV$ at voltage input 0 to 5V/0 to 4000. Integrated accuracy does not change. (Voltage input: $\pm 0.1V$, Current input: $\pm 0.16mA$)

The adjustment of the offset and gain values sets a digital equivalent to the analogue data. (The "POT" requires 18 revolutions to move between MIN and MAX setting.)

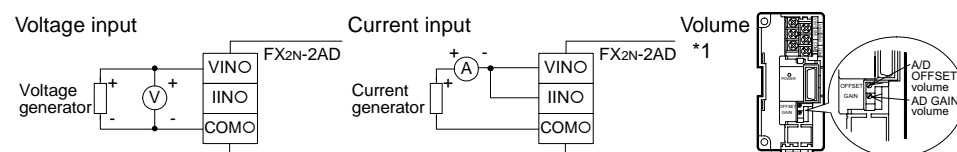

*1 The digital value increases if the volume is turned clockwise. (FX2N-4DA and FX2N-2DA can be used instead of the voltage and current generator)

7.1.1 Adjustment of gain

The gain value can be set to an arbitrary digital value. However, using the maximum 12bit resolution provides the user with a digital range of 0 to 4000.

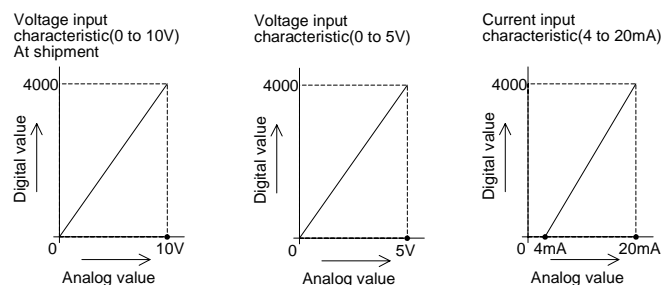

7.1.2 Adjustment of offset

The offset value can be set to an arbitrary digital value. However, it is advisable to set the analog value when the digital value is set as following.

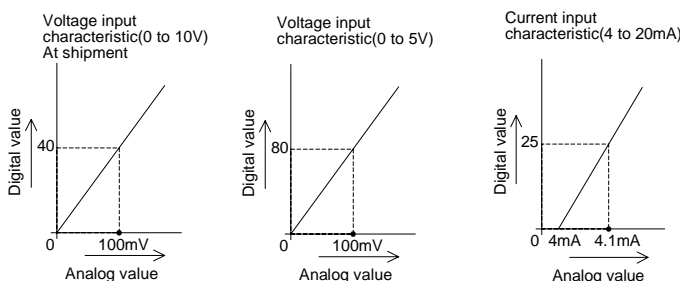

For instance, when a digital range of 0 to 4000 is used with the analog range of 0 to 10V, a digital value of 40 is equal to an analog input of 100mV. ($40 \times 10V/4000$ digital points)

- 1) The offset and gain adjustments for CH1 and CH2 are accomplished at the same time. When the offset and gain values of one channel are adjusted, the other channel is automatically adjusted.
- 2) Repeat the offset and gain adjustment alternately until a stable value is reached.
- 3) Each channel is common to the analog input circuit. However, check each channel individually for maximum accuracy.
- 4) Adjust offset / gain by using subsection 8-3 "Example of programming making average value data" when a digital value is not steady.
- 5) Adjust the gain before the offset.

8. Program example

The following program examples (8.1 and 8.3) are formula circuits. The device numbers that have been underlined can be assigned by the user during programming.

8.1 Example of programming analog input

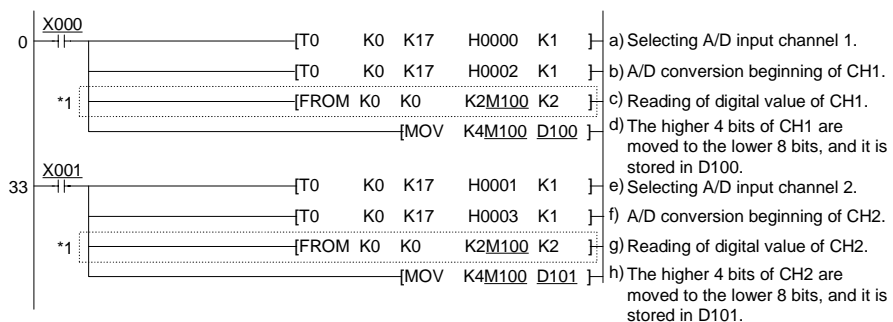

Analog to digital conversion execution input of CH1:X000
Analog to digital conversion execution input of CH2:X001
At the same time X000 and X001 can be turned ON.
A/D input data CH1 :D100 (Replace with auxiliary relay M100 to M115. Assign these numbers only once)
A/D input data CH2 :D101 (Replace with auxiliary relay M100 to M115. Assign these numbers only once)
Processing time: 2.5ms / 1 channel
(Time from turning on X000 and X001 to storage of analog to digital conversion value in data register of main unit.)

*1 Change the circuit of "*1" as follows when using an FX0N PLC

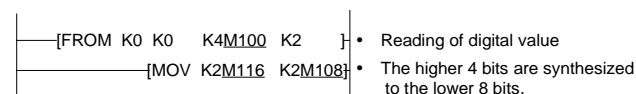

8.2 Connection to FX2N (V3.00 or later) or FX2NC (V3.00 or later) Series PLC

Please use FNC 176 (RD3A). Refer to FX Series Programming Manual II.

8.3 Example of programming making average value data

Add the undermentioned program after "8.1 Example of programming analog input" and use the average value data when you can not read a stable digital value.

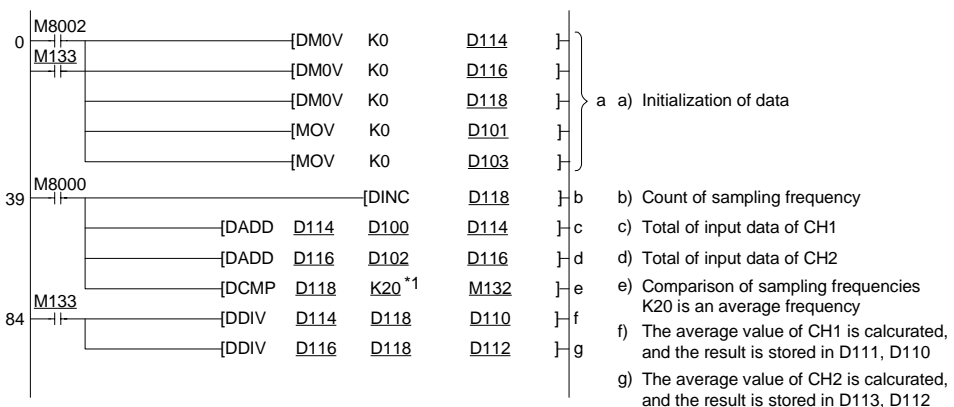

A/D input data of CH1 :D100
A/D input data of CH2 :D102
Sampling frequency :D118
Agreement flag of sampling frequency and average frequency :M133
Average value of CH1 :D111, D110
Average value of CH2 :D113, D112

*1 The above program example has an average sampling frequency of 20. Make the average frequency within the range of 2 to 262143.

9. Notes in drive

- 1) Confirm whether the input wiring of FX2N-2AD and the connection of the extension cable is correctly done.
- 2) Confirm whether the "4. Connection with programmable controller" condition is satisfied.
- 3) When shipped from the factory, the input characteristic is adjusted to 0 to 10V DC. If a different input characteristic is desired, please adjust as required. When the input characteristic is adjusted, the input characteristics of CH1 and CH2 are changed.
- 4) The coexistence use for the current and voltage input cannot be done with two channels.

10. Error check

Confirm the following items when it seems that the FX2N-2AD does not operate normally.

- 1) Confirm the state of POWER LED.
Lit :The extension cable is correctly connected.
Turn off or blinks :Confirm the proper connection of the extension cable.
- 2) Confirm the external wiring per section "3. Wiring".
- 3) Confirm whether the load resistance of the connected equipment corresponds to the specification of the FX2N-2AD.
- 4) Confirm the Voltage and Current input values with a voltage and current generator. Confirm the analog to digital conversion from the input characteristic.
- 5) Readjust the offset and gain by "7. Adjustment of offset and gain" when the analog to digital conversion is not suitable for the input characteristic. The input characteristic when shipped from the factory is 0 to 10V DC.

Guidelines for the safety of the user and protection of the FX2N-2AD SPECIAL FUNCTION BLOCK

- This manual has been written to be used by trained and competent personnel. This is defined by the European directives for machinery, low voltage and EMC.
- If in doubt at any stage during the installation of the FX2N-2AD always consult a professional electrical engineer who is qualified and trained to the local and national standards. If in doubt about the operation or use of the FX2N-2AD please consult the nearest Mitsubishi Electric distributor.
- Under no circumstances will Mitsubishi Electric be liable or responsible for any consequential damage that may arise as a result of the installation or use of this equipment.
- All examples and diagrams shown in this manual are intended only as an aid to understanding the text, not to guarantee operation. Mitsubishi Electric will accept no responsibility for actual use of the product based on these illustrative examples.
- Owing to the very great variety in possible application of this equipment, you must satisfy yourself as to its suitability for your specific application.

Manual number : JY992D74701

Manual revision : D

Date : SEPTEMBER 2002

MITSUBISHI ELECTRIC CORPORATION

HEAD OFFICE : MITSUBISHI DENKI BLDG MARUNOUCHI TOKYO 100-8310 TELEX : J24532 CABLE MELCO TOKYO
HIMEJI WORKS : 840, CHIYODA CHO, HIMEJI, JAPAN

JY992D74701D

Effective Sep. 2002
Specifications are subject to
change without notice