

# FX<sub>0N</sub>

FX<sub>0N</sub>-485ADP

## Installation Manual

JY992D53101D

This manual contains text, diagrams and explanations which will guide the reader in the correct installation, safe use and operation of the FX<sub>0N</sub>-485ADP (hereafter abbreviated to "485ADP") and should be read and understood before attempting to install or use the unit. Further information can be found in the associated manuals mentioned below.

Specifications are subject to change without notice

### Safety guidelines for the user and protection of the FX<sub>0N</sub>-485ADP.

This manual has been written to be used by trained and competent personnel. The definition of such a person or persons is as follows:

- Any engineer using the product associated with this manual, should be of a competent nature, trained and qualified to the local and national standards. These engineers should be fully aware of all aspects of safety with regards to automated equipment.
- Any commissioning or service engineer must be of a competent nature, trained and qualified to the local and national standards.
- All operators of the completed equipment should be trained to use this product in a safe and coordinated manner in compliance to established safety practices.

**Note:** The term 'completed equipment' refers to a third party constructed device which contains or uses the product associated with this manual.

### Notes on the Symbols Used in this Manual

At various times throughout this manual certain symbols will be used to highlight points of information which are intended to ensure the users personal safety and protect the integrity of equipment.



- 1) Indicates that the identified danger **WILL** cause physical and property damage.



- 2) Indicates that the identified danger could **POSSIBLY** cause physical and property damage.

- Under no circumstances will Mitsubishi Electric be liable or responsible for any consequential damage that may arise as a result of the installation or use of this equipment.
- All examples and diagrams shown in this manual are intended only as an aid to understanding the text, not to guarantee operation. Mitsubishi Electric will accept no responsibility for the actual use of the product based on these illustrative examples.
- Please contact a Mitsubishi distributor for more information concerning applications in life critical situations or high reliability.

### Associated Manuals

PROGRAMMING MANUAL, PROGRAMMING MANUAL II, or FX COMMUNICATION USER'S MANUAL mentioned below are not provided in sets with a product.

Contact our agent where the product was purchased to request the manuals accordingly.

	Manual Name	Manual Number	Description
This manual	FX <sub>0N</sub> -485ADP INSTALLATION MANUAL	JY992D53101	Describes contents related to installation of the FX <sub>0N</sub> -485ADP Module.
★	FX COMMUNICATION USER'S MANUAL	JY992D69901	Describes contents related to communication available in FX Series PLC such as wiring, communication setting, and program examples.
☆	FX <sub>1S</sub> HARDWARE MANUAL	JY992D83901	Describes contents related to hardware of FX Series PLC such as specifications, wiring, and installation.
☆	FX <sub>0</sub> /FX <sub>0N</sub> HARDWARE MANUAL	JY992D47501	
☆	FX <sub>1N</sub> HARDWARE MANUAL	JY992D89301	
☆	FX <sub>2N</sub> HARDWARE MANUAL	JY992D66301	
☆	FX <sub>2NC</sub> HARDWARE MANUAL (DSS/DS) (D/UL)	JY992D76401 JY992D87201	
☆	PROGRAMMING MANUAL	JY992D76401	Describes contents related to instruction in FX <sub>0</sub> /FX <sub>0S</sub> /FX <sub>0N</sub> /FX <sub>2</sub> /FX <sub>2C</sub> Series PLC.
☆	PROGRAMMING MANUAL II	JY992D88101	Describes contents related to instruction in FX <sub>1S</sub> /FX <sub>1N</sub> /FX <sub>2N</sub> /FX <sub>2NC</sub> Series PLC.
☆	FX <sub>1N</sub> -CNV-BD Special Adapter Connection Board	JY992D84701	Describes contents related to installation of the each board.
☆	FX <sub>2N</sub> -CNV-BD Special Adapter Connection Board	JY992D63601	

★ Indispensable manual      ☆ Either manual is necessary.

This manual describes the installation the and specifications of the 485ADP.  
 For details on wiring (including use of terminal resistor and preparation of cable) with communication equipment, system configuration and communication setting, and program examples, refer to the "FX COMMUNICATION USER'S MANUAL".

# 1. Outline of Product

The 485ADP is an insulated RS-485 communication adapter with an Terminal block for connecting RS-485 equipment.

Connected to the main unit of the FX Series PLC, it enables signal exchange between the PLC and equipment via an RS-485 port.

# 2. Communication Functions and Applicable PLC (Available in indicated version or later)

Communication type	FX0N	FX1N FX1S	FX2N	FX2NC	Function
N:N network	V2.00	First product	V2.00	First product	Data transfer connecting up to eight FX Series PLCs.
Parallel link	V1.20	First product	V1.04	First product	Data transfer between two PLCs relationship specifying master/slave station.
Computer link	V1.20	First product	V1.06	First product	Data transfer via link protocol between PLC and computer (specified as the master station).
No protocol communication	V1.20	First product	V1.06	First product	Serial communication without protocol between PLC and equipment via RS-485 interface.
Inverter communication	—	—	V3.00	V3.00	Controlling Mitsubishi's FREQROL inverter using EXTR instruction in function expansion memory.

# 3. Installation

## Caution



- Use in the environments specified under the general specification in the manual. Do not use the product in environments with excessive or conductive dust, corrosive or flammable gas, oily smoke, moisture or rain, excessive heat, regular impact shocks or excessive vibration, as it may result in electrical shock, fire, malfunction, damage or deterioration on the product.
- Make sure to shut off the power outside the product before installing or wiring it. Otherwise, electric shock or serious damage to the product may occur.
- Never drop wire chips or shavings into the vent slits when drilling screw holes or performing wiring, as they may cause fire, breakdown, or malfunction.
- Securely install the 485ADP to the designated port. Poor connection may cause malfunction.

## 3.1 How to Install to FX Series PLC

### Installation to FX1S/FX1N/FX2N

Turn OFF the PLC before beginning any work.

- Remove the panel cover from the top face of the main unit.
- Take off the resin cover from the left side of the main unit.
- Install the following board to the port on the main unit.

Board name	Corresponding model
FX1N-CNV-BD	FX1N, FX1S
FX2N-CNV-BD	FX2N

- Fix the above board using the M3 screws supplied. Tightening torque: 0.3 to 0.6 N·m
- Connect the in-built cable of the 485ADP to the port on the board from the left side.

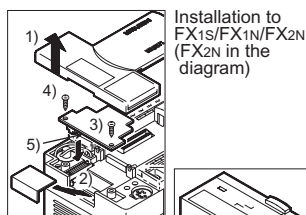

Installation to FX1S/FX1N/FX2N (FX2N in the diagram)

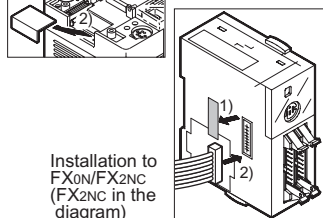

Installation to FX0N/FX2NC (FX2NC in the diagram)

### Installation to FX0N/FX2NC

Turn OFF the PLC before beginning any work.

- Remove the cover of the port for a special adapter provided on the left side of the main unit.
- Connect the in-built cable of the 485ADP to the port for a special adapter.

## 3.2 How to Install to Panel Face

### Direct installation to the panel face

Directly fix to the panel face using 2 sets of a screw (M4), a spring washer, and a flat washer in the mounting holes.

Tightening torque: 0.7 to 1.0 N·m

For the pitch and positions of mounting screw holes, refer to the external dimensions.

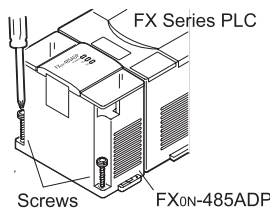

### Mounting on DIN rail

Fix the 485ADP to the DIN rail, DIN46277 (35 mm (1.37") wide).

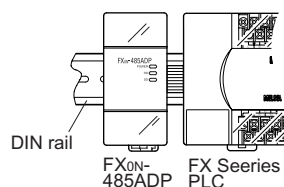

### Dismounting from DIN rail

Slightly pull down the DIN rail mounting clip using a tool such as a slotted screwdriver.

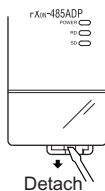

## 4. Product Specification

### 4.1 Specification

All other specifications than the followings are equivalent to those of the FX Series PLC main unit.

	Item	Specification
General specification	Withstand voltage	500 V AC, 1 min (Between all terminals in batch and FG terminal)
	Insulation resistance	5 MΩ or more, 500 V DC by Megger (Between all terminals in batch and FG terminal)
Power supply specification	Power supply voltage, current	5 V DC (supplied from PLC main unit) max. 30 mA 24 V DC (supplied from External power supply) max. 50 mA
Performance specification	Transmission standard	Conforming to RS-485/RS-422
	Type of isolation	Photo-coupler isolation
	Transmission distance	Total extension distance: 500 m or less (50 m or less if FX <sub>2N</sub> -485-BD or FX <sub>1N</sub> -485-BD is installed in connected equipment)
	Number of occupied I/O points	0 point (unrelated to maximum number of controlled points of the PLC)
	Communication method	Half-duplex
	Baud rate	N:N network: 384000 bps, Parallel link: 19200bps Computer link, No protocol: 300/600/1200/2400/4800/9600/19200 bps
	Communication format	N:N network, Parallel link Computer (dedicated protocol: format 1/format 4), No protocol
	LED display (LED color)	Power: green, RD: red, SD: red

### 4.2 Outside Dimensions and Part Names

- 1) Top cover
- 2) POWER LED  
Lighting while power is correctly supplied.
- 3) RD LED  
Lighting while receiving data.
- 4) SD LED  
Lighting while sending data.
- 5) Extension cable
- 6) Direct mounting hole
- 7) DIN rail mounting slot (DIN rail width :35 (1.37"))
- 8) DIN rail mounting clip

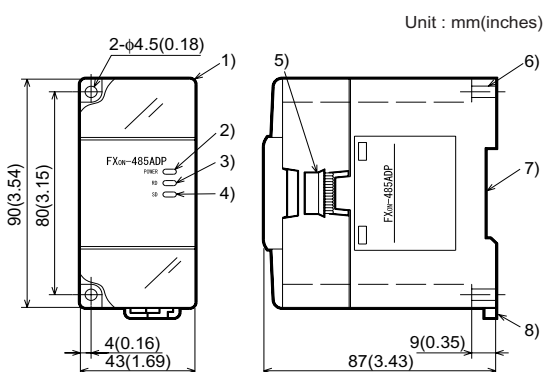

Weight: Approx. 0.3 kg (0.66 lbs)  
 Color: Munsell 0.08GY 7.64/0.81  
 DIN rail width: 35 mm (1.37")  
 Accessories: Terminal resistors (330 Ω x 2 and 110 Ω x 1), Station number label for linking

### 4.3 Terminal configuration and terminal screws

The terminal configuration of the RS-485 port on the 485ADP is as shown below.

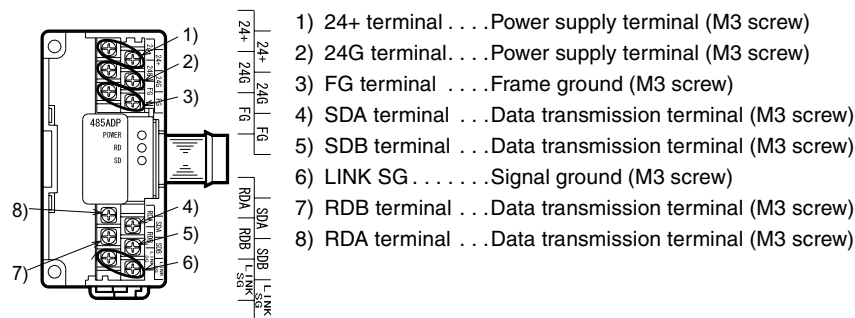

Terminals screws of terminal block for RS-485 are M3 threaded. Therefore, connect wiring by fitting a crimped terminal suited to the terminal screws (see below) to the cable.

Tightening torque of terminals is 0.5 to 0.8 N·m. Screw terminals must be secure enough to prevent a loose connection from causing a malfunction.

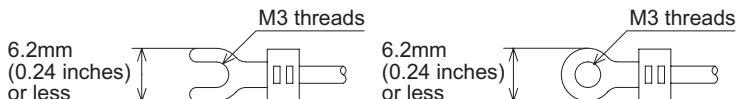

Manual number : JY997D53101

Manual revision : D

Date : September 2003

**MITSUBISHI ELECTRIC CORPORATION**

HEAD OFFICE : MITSUBISHI DENKI BLDG MARUNOUTI TOKYO 100-8310  
 HIMEJI WORKS : 840, CHIYODA CHO, HIMEJI, JAPAN



Changes for the Better

# FX<sub>ON</sub>

## FX<sub>ON</sub>-485ADP Installation Manual

JY992D53101D

This manual contains text, diagrams and explanations which will guide the reader in the correct installation, safe use and operation of the FX<sub>ON</sub>-485ADP (hereafter abbreviated to "485ADP") and should be read and understood before attempting to install or use the unit. Further information can be found in the associated manuals mentioned below.

Specifications are subject to change without notice

### Safety guidelines for the user and protection of the FX<sub>ON</sub>-485ADP.

This manual has been written to be used by trained and competent personnel. The definition of such a person or persons is as follows:

- Any engineer using the product associated with this manual, should be of a competent nature, trained and qualified to the local and national standards. These engineers should be fully aware of all aspects of safety with regards to automated equipment.
- Any commissioning or service engineer must be of a competent nature, trained and qualified to the local and national standards.
- All operators of the completed equipment should be trained to use this product in a safe and coordinated manner in compliance to established safety practices.

**Note:** The term "completed equipment" refers to a third party constructed device which contains or uses the product associated with this manual.

### Notes on the Symbols Used in this Manual

At various times throughout this manual certain symbols will be used to highlight points of information which are intended to ensure the users personal safety and protect the integrity of equipment.

- 1) Indicates that the identified danger **WILL** cause physical and property damage.
- 2) Indicates that the identified danger could **POSSIBLY** cause physical and property damage.

- Under no circumstances will Mitsubishi Electric be liable or responsible for any consequential damage that may arise as a result of the installation or use of this equipment.
- All examples and diagrams shown in this manual are intended only as an aid to understanding the text, not to guarantee operation. Mitsubishi Electric will accept no responsibility for the actual use of the product based on these illustrative examples.
- Please contact a Mitsubishi distributor for more information concerning applications in life critical situations or high reliability.

### Associated Manuals

PROGRAMMING MANUAL, PROGRAMMING MANUAL II, or FX COMMUNICATION USER'S MANUAL mentioned below are not provided in sets with a product. Contact our agent where the product was purchased to request the manuals accordingly.

	Manual Name	Manual Number	Description
This manual	FX <sub>ON</sub> -485ADP INSTALLATION MANUAL	JY992D53101	Describes contents related to installation of the FX <sub>ON</sub> -485ADP Module.
★	FX COMMUNICATION USER'S MANUAL	JY992D69901	Describes contents related to communication available in FX Series PLC such as wiring, communication setting, and program examples.
☆	FX <sub>1S</sub> HARDWARE MANUAL	JY992D83901	Describes contents related to hardware of FX Series PLC such as specifications, wiring, and installation.
☆	FX <sub>0</sub> /FX <sub>ON</sub> HARDWARE MANUAL	JY992D47501	
☆	FX <sub>1N</sub> HARDWARE MANUAL	JY992D89301	
☆	FX <sub>2N</sub> HARDWARE MANUAL	JY992D66301	
☆	FX <sub>2NC</sub> HARDWARE MANUAL (DSS/DS) (D/UL)	JY992D76401 JY992D87201	Describes contents related to instruction in FX <sub>0</sub> /FX <sub>0S</sub> /FX <sub>ON</sub> /FX <sub>1</sub> /FX <sub>2</sub> /FX <sub>2C</sub> Series PLC.
☆	PROGRAMMING MANUAL	JY992D76401	
☆	PROGRAMMING MANUAL II	JY992D88101	Describes contents related to instruction in FX <sub>1S</sub> /FX <sub>1N</sub> /FX <sub>2N</sub> /FX <sub>2NC</sub> Series PLC.
☆	FX <sub>1N</sub> -CNV-BD Special Adapter Connection Board	JY992D84701	Describes contents related to installation of the each board.
☆	FX <sub>2N</sub> -CNV-BD Special Adapter Connection Board	JY992D63601	

★ Indispensable manual ☆ Either manual is necessary.

This manual describes the installation the and specifications of the 485ADP. For details on wiring (including use of terminal resistor and preparation of cable) with communication equipment, system configuration and communication setting, and program examples, refer to the "FX COMMUNICATION USER'S MANUAL".

## 1. Outline of Product

The 485ADP is an insulated RS-485 communication adapter with an Terminal block for connecting RS-485 equipment.

Connected to the main unit of the FX Series PLC, it enables signal exchange between the PLC and equipment via an RS-485 port.

## 2. Communication Functions and Applicable PLC (Available in indicated version or later)

Communication type	FX <sub>ON</sub>	FX <sub>1N</sub> FX <sub>1S</sub>	FX <sub>2N</sub>	FX <sub>2NC</sub>	Function
N:N network	V2.00	First product	V2.00	First product	Data transfer connecting up to eight FX Series PLCs.
Parallel link	V1.20	First product	V1.04	First product	Data transfer between two PLCs relationship specifying master/slave station.
Computer link	V1.20	First product	V1.06	First product	Data transfer via link protocol between PLC and computer (specified as the master station).
No protocol communication	V1.20	First product	V1.06	First product	Serial communication without protocol between PLC and equipment via RS-485 interface.
Inverter communication	—	—	V3.00	V3.00	Controlling Mitsubishi's FREQROL inverter using EXTR instruction in function expansion memory.

## 3. Installation



### Caution

- Use in the environments specified under the general specification in the manual. Do not use the product in environments with excessive or conductive dust, corrosive or flammable gas, oily smoke, moisture or rain, excessive heat, regular impact shocks or excessive vibration, as it may result in electrical shock, fire, malfunction, damage or deterioration on the product.
- Make sure to shut off the power outside the product before installing or wiring it. Otherwise, electric shock or serious damage to the product may occur.
- Never drop wire chips or shavings into the vent slits when drilling screw holes or performing wiring, as they may cause fire, breakdown, or malfunction.
- Securely install the 485ADP to the designated port. Poor connection may cause malfunction.

### 3.1 How to Install to FX Series PLC

#### Installation to FX<sub>1S</sub>/FX<sub>1N</sub>/FX<sub>2N</sub>

Turn OFF the PLC before beginning any work.

- Remove the panel cover from the top face of the main unit.
- Take off the resin cover from the left side of the main unit.
- Install the following board to the port on the main unit.

Board name	Corresponding model
FX <sub>1N</sub> -CNV-BD	FX <sub>1N</sub> , FX <sub>1S</sub>
FX <sub>2N</sub> -CNV-BD	FX <sub>2N</sub>

- Fix the above board using the M3 screws supplied. Tightening torque: 0.3 to 0.6 N·m
- Connect the in-built cable of the 485ADP to the port on the board from the left side.

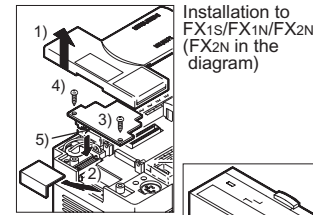

Installation to FX<sub>ON</sub>/FX<sub>2NC</sub> (FX<sub>2NC</sub> in the diagram)

#### Installation to FX<sub>ON</sub>/FX<sub>2NC</sub>

Turn OFF the PLC before beginning any work.

- Remove the cover of the port for a special adapter provided on the left side of the main unit.
- Connect the in-built cable of the 485ADP to the port for a special adapter.

### 3.2 How to Install to Panel Face

#### Direct installation to the panel face

Directly fix to the panel face using 2 sets of a screw (M4), a spring washer, and a flat washer in the mounting holes. Tightening torque: 0.7 to 1.0 N·m  
For the pitch and positions of mounting screw holes, refer to the external dimensions.

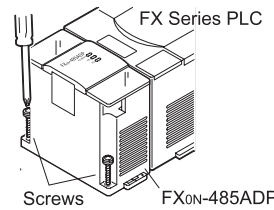

#### Mounting on DIN rail

Fix the 485ADP to the DIN rail, DIN46277 (35 mm (1.37") wide).

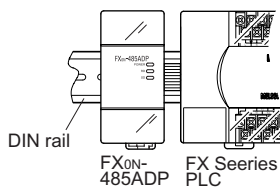

#### Dismounting from DIN rail

Slightly pull down the DIN rail mounting clip using a tool such as a slotted screwdriver.

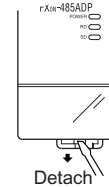

## 4. Product Specification

### 4.1 Specification

All other specifications than the followings are equivalent to those of the FX Series PLC main unit.

	Item	Specification
General specification	Withstand voltage	500 V AC, 1 min (Between all terminals in batch and FG terminal)
	Insulation resistance	5 MΩ or more, 500 V DC by Megger (Between all terminals in batch and FG terminal)
Power supply specification	Power supply voltage, current	5 V DC (supplied from PLC main unit) max. 30 mA 24 V DC (supplied from External power supply) max. 50 mA
Performance specification	Transmission standard	Conforming to RS-485/RS-422
	Type of isolation	Photo-coupler isolation
	Transmission distance	Total extension distance: 500 m or less (50 m or less if FX <sub>2N</sub> -485-BD or FX <sub>1N</sub> -485-BD is installed in connected equipment)
	Number of occupied I/O points	0 point (unrelated to maximum number of controlled points of the PLC)
	Communication method	Half-duplex
	Baud rate	N:N network: 384000 bps, Parallel link: 19200bps Computer link, No protocol: 300/600/1200/2400/4800/9600/19200 bps
	Communication format	N:N network, Parallel link Computer (dedicated protocol: format 1/format 4), No protocol
LED display (LED color)	Power: green, RD: red, SD: red	

### 4.2 Outside Dimensions and Part Names

- Top cover
- POWER LED  
Lighting while power is correctly supplied.
- RD LED  
Lighting while receiving data.
- SD LED  
Lighting while sending data.
- Extension cable
- Direct mounting hole
- DIN rail mounting slot (DIN rail width :35 (1.37"))
- DIN rail mounting clip

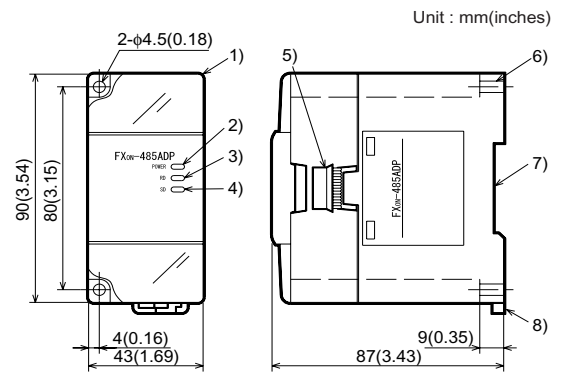

Unit : mm(inches)  
Weight: Approx. 0.3 kg (0.66 lbs)  
Color: Munsell 0.08GY 7.64/0.81  
DIN rail width: 35 mm (1.37")  
Accessories: Terminal resistors (330 Ω x 2 and 110 Ω x 1), Station number label for linking

### 4.3 Terminal configuration and terminal screws

The terminal configuration of the RS-485 port on the 485ADP is as shown below.

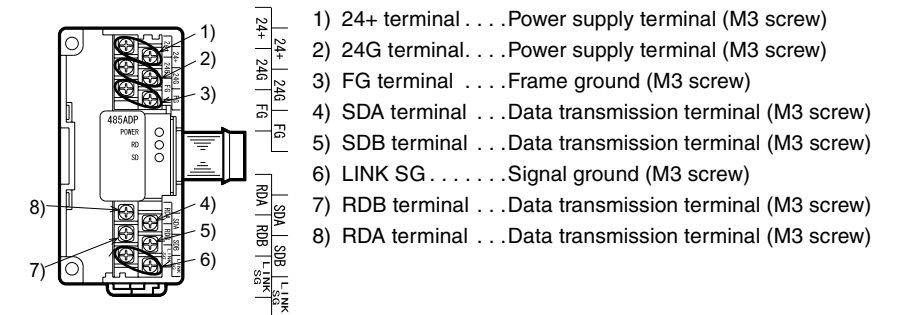

Terminals screws of terminal block for RS-485 are M3 threaded. Therefore, connect wiring by fitting a crimped terminal suited to the terminal screws (see below) to the cable. Tightening torque of terminals is 0.5 to 0.8 N·m. Screw terminals must be secure enough to prevent a loose connection from causing a malfunction.

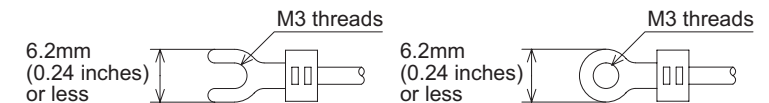

Manual number : JY992D53101

Manual revision : D

Date : September 2003