

# **FX-10GM POSITIONING CONTROLLER USER'S GUIDE**

Manual number: JY992D68401  
Manual revision: A  
Date: September 1997

## **Foreword**

- This manual only describes the specifications for FX-10GM positioning controller. For complete operation, wiring, mounting and programming instructions please refer to the FX-10GM, FX(E)-20GM HARDWARE/PROGRAMMING MANUAL, FX PROGRAMMING MANUAL and FX SERIES HARDWARE MANUAL.
- Before attempting to install or use the FX-10GM unit this manual and FX-10GM,FX(E)-20GM HARDWARE/PROGRAMMING MANUAL should be read and understood.
- If in doubt at any stage of the installation of the FX-10GM unit always consult a professional electrical engineer who is qualified and trained to the local and national standards which apply to the installation site.
- If in doubt about the operation or use of the FX-10GM unit please consult the nearest Mitsubishi Electric distributor.
- This manual is subject to change without notice.



**Guidelines for the safety of the user and protection of the FX-10GM unit**

This manual provides information for the use of the FX-10GM unit. The manual has been written to be used by trained and competent personnel. The definition of such a person or persons is as follows;

- a) Any engineer who is responsible for the planning, design and construction of automatic equipment using the product associated with this manual should be of a competent nature, trained and qualified to the local and national standards required to fulfill that role. These engineers should be fully aware of all aspects of safety with regards to automated equipment.
- b) Any commissioning or service engineer must be of a competent nature, trained and qualified to the local and national standards required to fulfill that job. These engineers should also be trained in the use and maintenance of the completed product. This includes being completely familiar with all associated documentation for the said product. All maintenance should be carried out in accordance with established safety practices.
- c) All operators of the completed equipment should be trained to use that product in a safe and co-ordinated manner in compliance to established safety practices. The operators should also be familiar with documentation which is connected with the actual operation of the completed equipment.

Note: the term 'completed equipment' refers to a third party constructed device which contains or uses the product associated with this manual.

**Notes on the symbology used in this manual**

At various times through out this manual certain symbols will be used to highlight points of information which are intended to ensure the users personal safety and protect the integrity of equipment. Whenever any of the following symbols are encountered its associated note must be read and understood. Each of the symbols used will now be listed with a brief description of its meaning.

**Hardware warnings**



Indicates that the identified danger WILL cause physical and property damage.



Indicates that the identified danger could POSSIBLY cause physical and property damage.



Indicates a point of further interest or further explanation.

**Software warning**



Indicates special care must be taken when using this element of software



Indicates a special point which the user of the associate software element should be aware of



Indicates a point of interest or further explanation

# CONTENTS

<b>1. INTRODUCTION .....</b>	<b>1 - 1</b>
1.1 Outline .....	1 - 1
1.2 System Configuration .....	1 - 2
1.2.1 Nomenclature .....	1 - 2
1.2.2 System configuration .....	1 - 3
1.3 External Dimensions .....	1 - 4
<b>2. SPECIFICATIONS .....</b>	<b>2 - 1</b>
2.1 General Specifications .....	2 - 1
2.2 Power Supply Specifications .....	2 - 1
2.2.1 Power Supply Specifications .....	2 - 1
2.2.2 Service power supply .....	2 - 2
2.3 Performance specifications .....	2 - 2
2.4 I/O Specifications .....	2 - 4
2.4.1 Input specifications .....	2 - 4
2.4.2 Output specifications .....	2 - 5
2.5 Optional Units .....	2 - 6

# 1. INTRODUCTION

This section explains the outline of the positioning unit and the related peripheral units.

In description, the FX-10GM may be abbreviated as "10GM".

For complete operation, wiring, mounting and programming instructions please refer to the FX-10GM, FX(E)-20GM HARDWARE/PROGRAMING MANUAL, FX PROGRAMMING MANUAL and FX SERIES HARDWARE MANUAL.

## 1.1 Outline

The FX-10GM positioning unit is the pulse chain output type, and enables the positioning control of the stepping motor or the servo motor via the drive unit.

Number of control axes	Positioning languages	Number of output pulses	Connection to Programmable controller
1	Dedicated language + Sequence language	1 to 200 kPPS	Connected to FX/FX2C or performs independently

### Number of control axes

FX-10GM: For one axis.

### Positioning languages

Both dedicated positioning language (cod instructions) and sequence language (basic instructions and application instructions).

The languages are compatible among the FX-10GM.

### Number of output pulses

High-speed pulse output from 1 PPS to 200 kPPS maximum.

### Programmable controller connected

The FX-10GM can be connected to the FX/FX<sub>2c</sub> Series programmable controller to read or write the positioning data. Each unit can also be used independently.

# 1.2 System Configuration

## 1.2.1 Nomenclature

This section explains the names of the terminals and the connectors provided in the FX-10GM.

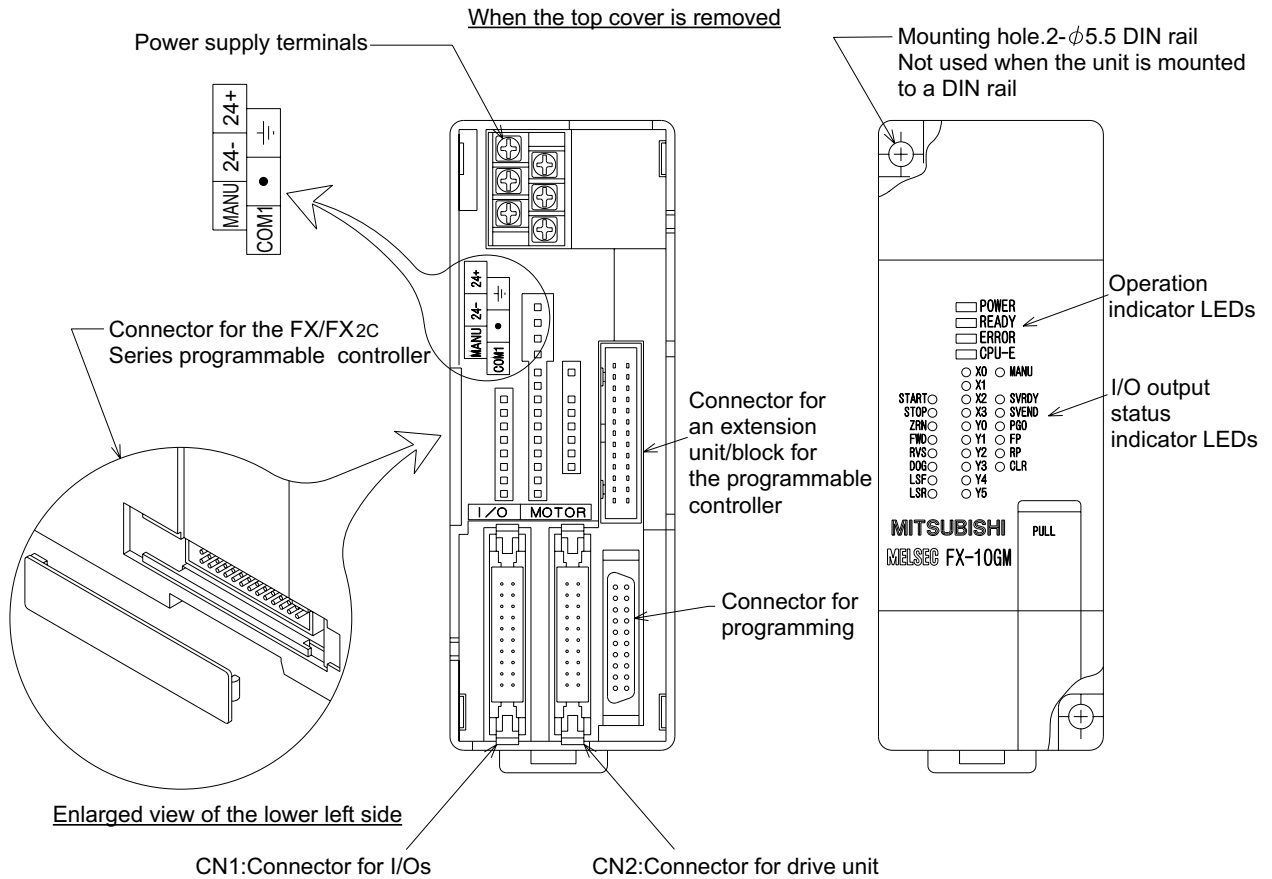

CN1: Connector for I/Os

CN2: Connector for drive unit

10	Y4	COM1	LSR	LSF	DOG	RVS	FWD	ZRN	STOP	START	1
20	Y5	COM1	Y3	Y2	Y1	Y0	X3	X2	X1	X0	11

11	SVEND	COM2	PG0	COM4	RP0	RP	24⊕	VC	COM5	ST2	20
1	SVRDY	COM2	CLR	COM3	FP0	FP	24⊕	VC	COM5	ST1	10

### 1.2.2 System configuration

This section explains the system configuration and I/O assignment of the FX-10GM.

#### Independent operation

- The FX-10GM can operate independently because it is equipped with a power supply of 24V DC, CPU, operation inputs, mechanical inputs and drive unit inputs/ outputs as described on the next page.
- The FX-10GM can be connected to external I/O devices because it is equipped with 4 input points (X0 to X3) and 6 output points (Y0 to Y5) as general purpose I/Os. When the I/O points are insufficient, use a programmable controller as described below.

#### Connecting a programmable controller

- Applicable programmable controller: FX or FX<sub>2C</sub> Series  
 The FX-10GM is treated as a special unit of the programmable controller. Eight special units (such as the analog I/O unit, the high-speed counter, etc.) including the FX-10GM can be connected to a programmable controller.

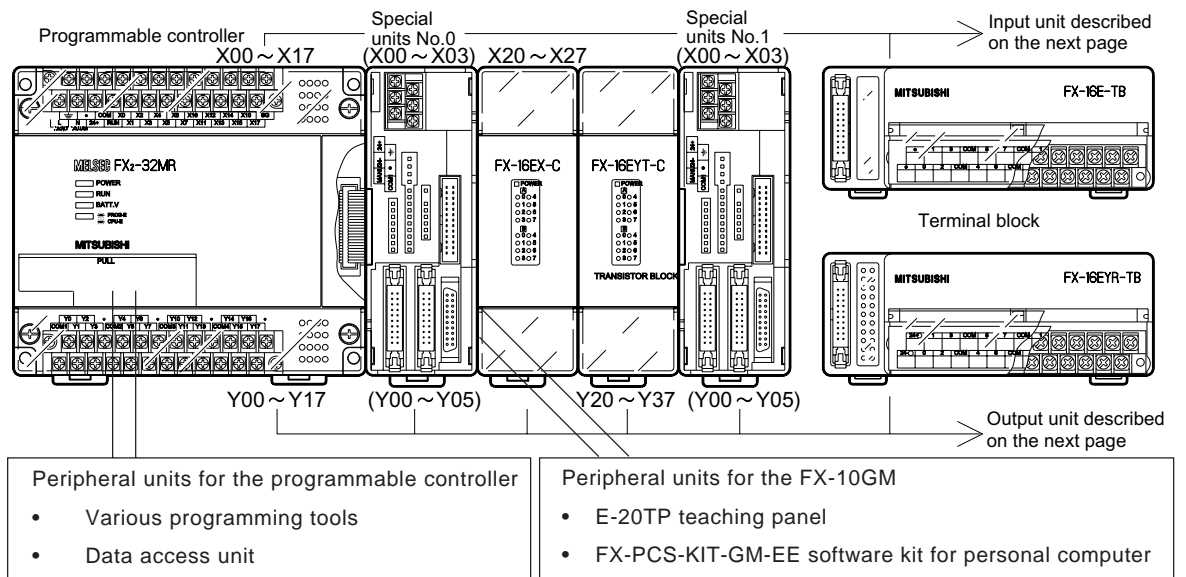

- I/O assignment  
 The FX-10GM is treated as a special unit of the programmable controller. The special unit Nos. 0 to 7 are automatically assigned to each of the special units from the unit closest to the programmable controller (The No. assigned here is regarded as the unit No. specified in the FROM/TO instruction.)  
 No I/Os of the programmable controller are assigned, and the general purpose I/Os of the FX-10GM are controlled by the 10GM.

#### Note

For details of the I/O assignment in the programmable controller, refer to the FX SERIES HARDWARE MANUAL. The number of extension blocks connected after the 10GM is limited. See section 2.2.2.

**Units for general I/O connection**

For the general I/Os of the positioning unit and the extension I/Os of the programmable controller the following external units can be connected.

- 1) Various input switches  
The various input switches such as a push-button switch, limit switch, sensor, etc. can be connected.
- 2) Manual pulse generator  
A pulse generator can be connected to each axis, or one pulse generator can be connected to both axes and switched between them. The manual pulse generators used must be an open collector output type.
- 3) Interrupt input  
The input from the manual pulse generator can be used as control input for interrupt positioning control by switching the line.

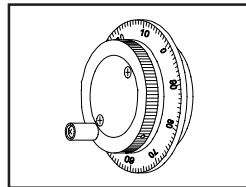

**General input/extension input**

- 1) Input from the digital switch

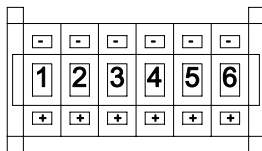

- Up to 6 digits are possible with the FX-10GM. Use with a programmable controller for more digits.

Various data settings can be fetched through connections that save wiring, either by a direct connection method or by multiplexing input/outputs.

The following data can be set using direct specification instructions.

- Target position
- Speed
- Center coordinates of circular arc
- Radius of circular arc
- Various parameters and control constants

**General output/extension output**

- 1) Auxiliary equipment control output  
The ON/OFF control outputs for various auxiliary equipment are generated by M code signals (2-digit BCD) or a direct program.
- 2) Seven-segment display

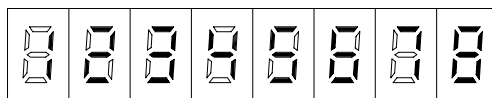
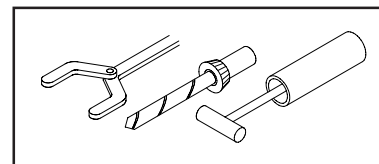

Various setting data and statuses, and present value, can be displayed through connections that save wiring, either by a direct connection method or by multiplexing outputs.

- a) Current position display:  
8 digits maximum for each axis.
- b) The line No. being executed, the set speed, the present dwell value, various parameters and the status can be read and displayed.
  - Up to 2 digits are possible with the FX-10GM. Use with a programmable controller for more digits.

- The positioning control command inputs and the drive unit connection are enabled via dedicated I/O.



**Units for dedicated I/O connection**

1) Operation system inputs

- Automatic start command
- Single-step operation command
- Stop command
- Zero return command
- Manual forward rotation command
- Manual reverse rotation command
- Manual/automatic selection

2) Mechanical system inputs

- Forward rotation limit
- Reverse rotation limit
- Near-point dog signal

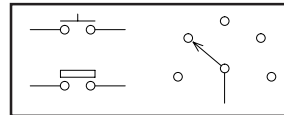

3) Drive unit

- Zero point signal
- Servo ready
- Servo end
- Forward/reverse rotation pulse sample
- Clear signal
- Absolute position detection signal
- etc.

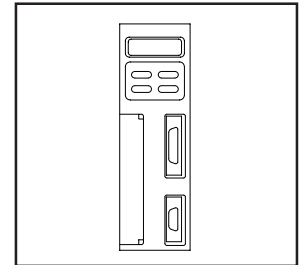

### 1.3 External Dimensions

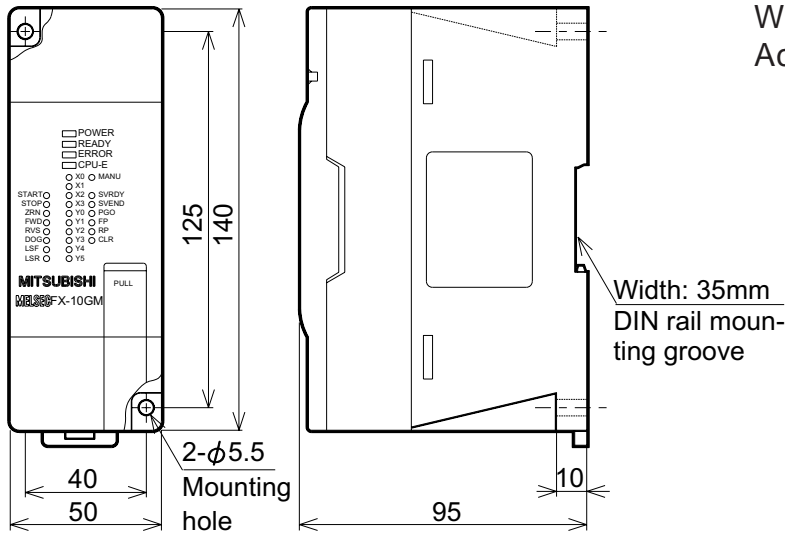

Weight : Approx. 0.4 kg  
 Accessory : Extention cable,  
 No. labels for special  
 function unit or block

## 2. SPECIFICATIONS

For complete operation wiring, mounting and programming instructions please refer to the FX-10GM, FX(E)-20GM HARDWARE/PROGRAMMING MANUAL, FX PROGRAMMING MANUAL and FX SERIES HARDWARE MANUAL.

### 2.1 General Specifications

Ambient temperature	Operating: 0 to +55 Storage: -20 to +70	
Ambient humidity	Operating: 35 to 85%RH, non condensing.	
Vibration resistance	Conforms to JIS C0911: 10 to 55Hz, 0.5mm, (2G maximum) *1 2 hours in 3 axis directions.	
Shock resistance	Conforms to JIS C0912: 10G three times in 3 axis directions.	
Noise resistance	By noise simulator with noise voltage 1,000Vp-p, noise width 1 μs and cycle 30 to 100Hz.	
Withstand voltage	500V AC for 1 minute	Between all terminals and ground.
Insulating resistance	5M Ω or more by 500V DC Megger.	
Grounding	Class 3 grounding (with strong power system is not allowed.) *2	
Ambient atmosphere	Free from corrosive gas and excessive dust.	

\*1 0.5G when mounted to a DIN rail.

\*2

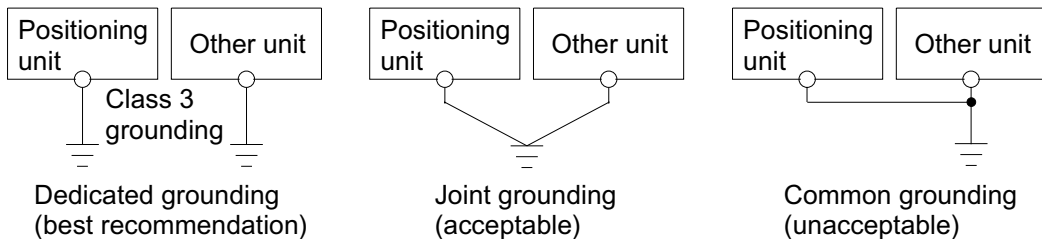

### 2.2 Power Supply Specifications

#### 2.2.1 Power Supply Specifications

Item	Specifications
Rated voltage	24V DC
Allowable voltage range	-15% to +10%
Allowable momentary power interruption time	Continues operation against momentary power interruption of 5 msec or less.
Power consumption	5W

### 2.2.2 Service power supply

- The drive power supply of the FX-10GM is 24V DC. There is no 24V DC service power supply for an external unit.
- When a programmable controller is used, extension blocks can be connected. The maximum total input and output points for non powered extension blocks is 48.
- The capacity of the 5V DC power supply for special extension blocks (such as the FX-2DA/4AD analog block, the FX-1HC high-speed counter, etc.) is 100 mA.
- When more than 48 I/O points are needed or when the capacity of the 5 V power supply is insufficient, use powered extension units.

## 2.3 Performance Specifications

Item	Specifications
Number of control axes	1
Applicable programmable controller	Bus connection with FX/FX2C Series PC, Number of I/O points occupied:8 points
Program memory	3.8k step EEPROM built in
Positioning units (incremental / absolute)	Command units:0.001,0.01,0.1mm(deg),0.1inch or 1,10,100,1000PLS Max. command value: $\pm 999,999$ (indirectly specified:32 bits)
Cumulative address	$\pm 2,147,483,647$ pulses
Speed commands	200kPPS max.,153,000cm/min Automatic trapezoidal pattern acceleration / deceleration
Zero return	Manual or automatic dog type machine zero return (with the dog search function). Automatic electrical zero return in accordance with the electrical zero position setting is possible.
Absolute position detection	When using the MR-H or the MR-J2A servo motor, simple absolute position detection is possible.

Item		Specifications
Control inputs	Operation system	MANU (manual), FED (manual forward rotation), RVS (manual reverse rotation), ZRN (machine zero return), START (automatic start), STOP (stop), manual pulse generator (2kPPS max.), single-step operation input (depending on parameter settings)
	mechanical system	Dog (near-point signal), LSF (forward rotation limit), LSR (reverse rotation limit), interrupts:4 points
	Servo system	SVRDY (servo ready), SVEND (servo end), PG0 (zero-point signal)
	General purpose	General purpose:X0 to X3
Control outputs	Servo system	RF (forward rotation pulse), RF (reverse rotation pulse), CLR (counter clear)
	General purpose	General purpose: Y0 to Y5
Program Nos.		Ox00 to Ox99, O100 (subtask program)
Instructions	Positioning	Cod No. system (used with instruction cods), 13 types
	Sequence	11 types: LD, LDI, AND, ANI, OR, ORI, ANB, ORB, SET, RST, NOP
	Application	FNC No. system, 29 types
M codes	maintask	m00 (WAIT) program stop and m02 (END) m01,m03 to m99 can be used as required (SFTER mode, WITH mode)
	Subtask	m100 (WAIT) and m102 (END) can be used
Parameters	System setting	9 types
	Positioning	27 types
	I/O control	18 types
Self-diagnosis		Diagnosis is enabled by the display of parameter errors, program errors and external errors with error code Noos.
Devices	Inputs	X0 to X3, X375 to X377
	Outputs	Y0 to Y5
	Auxilliary relays	M0 to M511 (general purpose)
		M9000 to M9175 (special purpose)
	Pointers	P0 to P127
	Data registers (16 bit)	D0 to D1999 (general purpose)
		D4000 to D6999 (file)
D9000 to D9313 (special purpose)		
Indexes	V0 to V7 (16 bit)	
	Z0 to Z7 (32 bit)	

Programming tool	E-20TP teaching panel	FX-PCS-KIT-GM-EE
	Program (reading / writing, insertion / deletion), parameters (reading / writing), operation monitor, testing (jog, machine zero return,	Personal computer (PC-AT)

## 2.4 I/O Specifications

### 2.4.1 Input Specifications

Input circuit configuration			
Input signal names	Group 1	MANU, START, STOP, ZRN, FWD, RVS, LSF, LSR	SVRDY, SVEND
	Group 2	DOG	PG0 *2
	Group 3	General inputs (X00 to X03)	—
	Group 4	Manual pulse generator, interrupt inputs	—
Circuit isolation		By photocoupler	By photocoupler
Operation indication		LED is lit while input is ON.	LED is lit while input is ON.
Signal voltage		24V DC ±10% (internal power supply)	5 to 24V DC ±10%
Input current		7 mA / 24V DC	7 mA / 24V DC (PG0 11.5 mA / 24V DC)
Input ON current		4.5 mA or more	0.6 mA or more (PG0 1.5 mA or more)
Input OFF current		1.5 mA or less	0.3 mA or less (PG0 0.5 mA or less)
Signal format		Contact input or NPN open collector transistor input.	
Response time	Group 1	Approx. 0.5 msec	Approx. 3 msec
	Group 2	Approx. 3 msec	Approx. 3 μsec
	Group 3	Approx. 0.1 msec *1	—
	Group 4	Approx. 3 msec *1	—

\*1 The selection of general purpose inputs, manual pulse generator inputs or interrupt inputs in the parameter settings automatically adjusts the input filters. The maximum response frequency for the manual pulse generator is 2 kPPS.

\*2 When using a stepping motor, short-circuit [ST1] and [ST2] terminals to each other to reduce the PG0 resistance from 3.3 kΩ to 1 kΩ.  
The input current also changes.  
PG0 4.9 mA/5V DC ON at 1.5 mA or less  
OFF at 0.5 mA or less

2.4.2 Output specifications

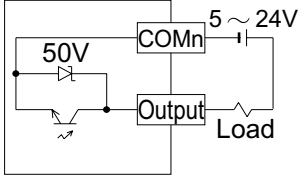
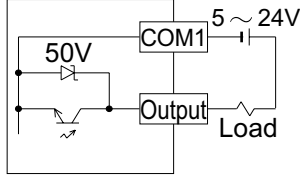
Item	Positioning unit drive output	Positioning unit general purpose output
Output circuit configuration		
Output signal names	FP (FP0), RP (RP0), CLR	X00 ~ X05
Circuit isolation	By photocoupler	By photocoupler
Operation indication	LED is lit while output is ON.	LED is lit while output is ON.
External power supply	5 to 24V DC $\pm 10\%$	5 to 24V DC $\pm 10\%$
Load current	20 mA or less	50 mA or less
Open circuit leak current	0.1 mA / 24V DC or less	0.1 mA / 24V DC or less
Output ON voltage	0.5V max. (1.5V max. for CLR)	0.5V max.
Response time	For pulse outputs FP (FP0) and RP (RP0): 200 kPPS max. Pulse output width of CLR signal: Approx. 20 msec	0.2 msec max. for both OFF $\rightarrow$ ON and ON $\rightarrow$ OFF.

## 2.5 Optional Units

When an I/O connector of the positioning unit is connected to a terminal block, the following cables are convenient.

### Optional cables

The following optional cables are available to connect the positioning unit.

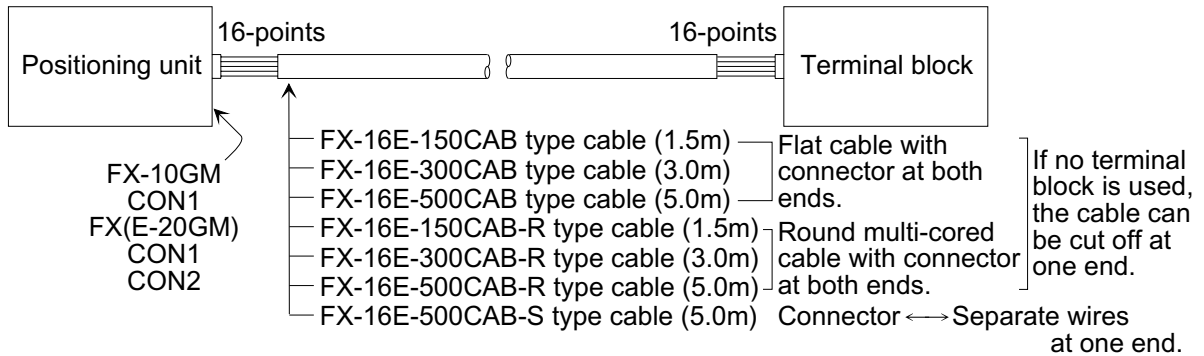

### Applicable connectors

The specifications for connector cables made by the user and for the connectors to be used when connecting additional equipment are indicated below.

1) When making a cable

① Flat cables

Wire size: AWG28 (0.1 mm<sup>2</sup>)  
1.27 pitch, 20 cores

Example of pressure displacement connectors (female)

- HIF3BA-20D-2.54R Hirose Denki
- FRC5-A020-3TOS Daiichi Denshi
- FRC2-A020-30S Daiichi Denshi

② Separate wires

Wire size: AWG22 to 20 (0.3 to 0.5 mm<sup>2</sup>)  
Solderless contacts: HU-411S (0.3 mm<sup>2</sup>)  
Daiichi Denshi  
HU-411SA (0.5 mm<sup>2</sup>)  
Daiichi Denshi

Housing: HU-200S2-001 Daiichi Denshi

- \* Depending on the variation in sheath thickness, it may be difficult to accommodate the wires in the housing.  
UL-1061 wires are recommended.

2) When connecting additional equipment

The destination side connectors to which Mitsubishi's optional cables can be connected include the following models.

- HIF3BA-20PA-2.54DSA Hirose Denki
- FRC5-C20S53T-OL Daiichi Denshi
- FRC2-C20S13-OL Daiichi Denshi

The internal connectors of the positioning unit and extension blocks are equivalent to the models indicated above.