

MITSUBISHI

AJ71QC24-R4

Serial Communications Module

**User's Manual
(Hardware)**

Thank you for choosing the Mitsubishi MELSEC-QnA Series of General Purpose Programmable Controllers. To ensure correct use of this equipment, please read this manual carefully before operating it.



IB(NA)-66611-A (9603) MEE

© 1996 MITSUBISHI ELECTRIC CORPORATION

Related Manuals

The following manuals are available for this equipment. Refer to the table given below to choose suitable manuals.

Manual Name	Manual No (Type Code)
Guide Book for the AJ71QC24 Serial Communications Module	IB-66622
User's Manual for the AJ71QC24(-R2/R4) Serial Communications Module	IB-66612

● **Safety Precautions** ●

Before using this equipment, please read this and related manuals thoroughly. Also pay special attention to safe and correct use of the equipment.

The safety precautions given in this section relate to this equipment only. For precautions regarding the programmable controller system, refer to the User's Manual for the CPU Module.

The following two safety precaution categories are used in this manual:

⚠ DANGER: Describes precautions that should be observed to prevent the danger of serious injury or death to the user in case of incorrect use of the equipment.

⚠ CAUTION: Describes precautions that should be observed to prevent the danger of medium or light injury to the user or physical damage to the equipment in case of incorrect use of the equipment.

However, note that incorrect use denoted by "⚠ CAUTION" may result in serious accident in some cases. Make sure that all the precautions given in this section are strictly observed.

Keep the manual in a safe place so that it can be referred to whenever necessary. Also make sure that this manual is forwarded to the final user.

[Precautions regarding system design]

⚠ CAUTION

- Never place the control cables and communication cables near the main circuit and power cables. Never bind them with the main circuit and power cables. Make sure that they are placed at least 100 mm away from the main circuit and power cables. Failure to observe this may result in malfunction of the equipment due to noise.

[Precautions regarding installation]

⚠ CAUTION

- Make sure that the equipment is used in the operating environment specified in this manual, otherwise electric shock, fire, malfunction, damage or deterioration of the equipment may result.
- When installing the equipment, make sure that the fixing projections provided at the base of the equipment are inserted into the holes on the base unit properly. If they are not properly inserted, a malfunction, breakdown or fall of the equipment may result.

[Precautions regarding wiring]

⚠ CAUTION

- Before connecting the cables, check the type of interface to be connected. If the cables are connected to an incorrect interface, damage to the equipment or external device may result.
- When connecting an external device to the RS-422 interface of the equipment, make sure that the external device is one which does not need power from the equipment. Failure to observe this may result in breakdown of the equipment or the external device.
- Make sure that each terminal screw is tightened with the specified torque. If the terminal screws are loose, short-circuit or malfunction may result.
- Take care not to allow any foreign matter, such as cutting refuse or wire bits, to enter the equipment. If they enter, fire, breakdown or malfunction may result.

[Precautions regarding set-up and maintenance]

⚠ DANGER

- Never touch the terminals while the power is supplied, otherwise malfunction may result.
- Before cleaning the equipment or re-tightening terminal screws, make sure that the power is turned OFF. If cleaning or re-tightening is carried out while the power is ON, breakdown or malfunction of the equipment may result.

⚠ CAUTION

- Never attempt to disassemble or modify the equipment, otherwise breakdown, malfunction, injury or fire may result.
- Before installing or removing the equipment, make sure that the power is turned OFF. If the equipment is installed or removed while the power is ON, breakdown or malfunction of the equipment may result.

[Precautions regarding disposal]

⚠ CAUTION

- When disposing of the equipment, treat it as industrial waste.

1. General Description

This manual describes specifications and names of each part of the AJ71QC24-R4 serial communications module, which is used in conjunction with the MELSEC-QnA series programmable controller CPU

When unpacking the equipment, check that the unit and parts listed in the table below are present

Product Name	Qty
AJ71QC24-R4 serial communications module	1
Terminator (330Ω), 1/4W (orange/orange/brown/□)	2
Terminator (110Ω), 1/2W (brown/brown/brown/□)	2

2. System Configuration

2.1 Applicable System (Applicable CPU module and allowable number of modules)

The following table shows programmable controller CPU module and network module (for remote station) which can be used with the equipment. The allowable number of modules to be installed is also given

Applicable Module	Allowable Number	Remarks
CPU module Q2A (S1) Q3A Q4A	Not limited	The allowable number of modules is determined according to the number of available input/output signals of the CPU module and remote station
Network module AJ72QLP25 AJ72QBR15		

3. Specifications

3.1 Communications

The communications specifications of the equipment is given below

Item	Specifications			
	CH1	CH2		
Interface:	RS-422	RS-422/485		
Communications method.	Full-duplex			
Synchronization.	Start-stop system			
Baud rate.	300 to 19200 BPS (CH1 and CH2 in total)			
Data format	Start bit.	1		
	Data bit.	7/8		
	Parity bit:	1 (yes) / 0 (no)		
	Stop bit:	1/2		
Error detection.	Parity check.	Yes (odd/even) / No		
	Sum check code.	Yes / No		
Control method.	DTR/DSCR.	Yes		
	DC code:	Yes (DC1/DC3, DC2/DC4) / No		
Writing to EEPROM.		100,000 times for the same area (Max.)		
Network connection:	Independent mode	Dedicated protocol	1 1	1 : 1, 1 : n, m n
		Modeless protocol		
		Bidirectional protocol		
	Interlock mode	Dedicated protocol	1 . n, m . n	
		Modeless protocol	1 . n	
		Bidirectional protocol	Data transfer disabled	
Allowable communications distance.		15 m or less	1200 m or less	
Power consumption.		5 VDC, 0.38A		
Number of I/O points.		32 points		
Weight.		0.385 kg		

3.2 RS-422 Interface (CH1)

3.2.1 Connector Pin Assignment

(1) Pin assignment of the RS-422 interface connector used for connection with an external device is described below

Pin No	Signal Name	Signal Code	Signal Direction (AJ71QC24-R4 ↔ External Device)
1	Signal ground	SG	↔
2	Received data (+)	RDA	←
3	Sent data (+)	SDA	→
4	Terminal ready (+)	DSRA	←
5	Data unit ready (+)	DTRA	→
7	Signal ground	SG	↔
8	Signal ground	SG	↔
15	Received data (-)	RDB	←
16	Sent data (-)	SDB	→
17	Terminal ready (-)	DSRB	←
18	Data unit ready (-)	DTRB	→
20	Signal ground	SG	↔
21	Signal ground	SG	↔

(2) Function block diagram for the RS-422 interface is given below

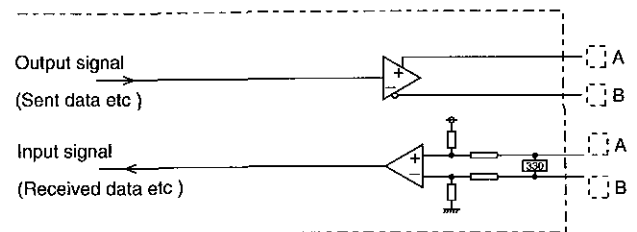

The following type of the RS-422 connector is used. The counter connector must match this connector

- 25-pin D-sub (female) screw type
- 17LE-10250-27-D9AC (Daiichi Denshi Kogyo)

3.2.2 RS-422 Cable

The RS-422 cable must be a shielded cable of 1200 m or shorter and conform to UL2467 (AWG#24)

(Recommended cable)
7/0 2 20C SRVD-SV (2464)

5. Handling Precautions

The equipment must be secured using screws. Allowable tightening torque range for the screws is given below.

Screw	Tightening Torque
RS-422/485 terminal block screws (M3.5)	58 to 88 N cm (6 to 9 kg cm)
Unit fixing screws (M4)	78 to 117 N cm (8 to 12 kg cm)
RS-422/485 terminal block screws (M3)	49 to 78 N cm (5 to 8 kg cm)

6. Starting up the Equipment

6.1 Set-up Procedure

This section describes how to start up the equipment.

For a detail description, refer to the User's Manual for the AJ71QC24(-R2/R4) Serial Communications Module.

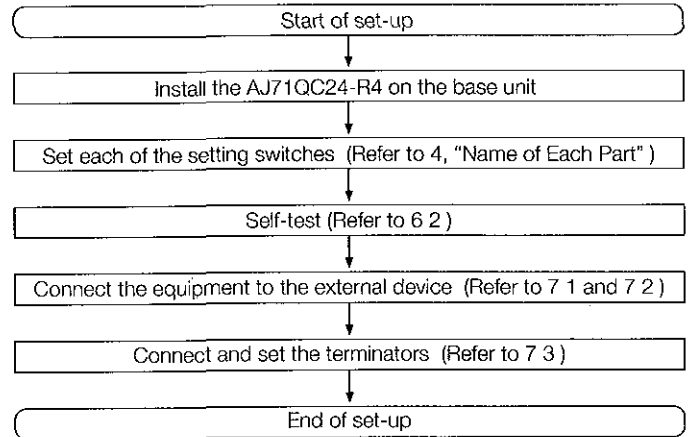

6.2 Self-Test

The following functions are provided to check whether the equipment can operate correctly, without being connected to an external device.

Make sure that the test is carried out with the programmable controller CPU in stop state. Also make sure that the power is turned OFF before connecting the cables and setting the switches.

6.2.1 ROM/RAM/Switch Test

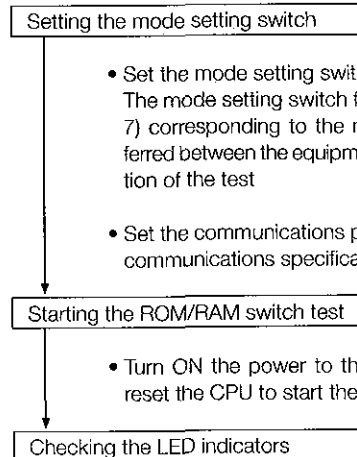

Check Item	LED Name	Normal	Abnormal	
(Test end)	SD WAIT *1		ON	
ROM check	CH1 ERR	OFF	ON	
RAM check	CH2.ERR	OFF	ON	
Switch check	Station No.	Located just below CH2 ERR	OFF	ON
	Mode	C/N *2	OFF	ON
	Communications parameter	P/S *2	OFF	ON
Interlock setting check	Mode	CH1-PRO	OFF	ON
	Communications parameter	CH1-SIO	OFF	ON

*1 LED for both CH1 and CH2

*2 LED for the interface where the setting error is occurring

②	Station No setting switch X10 X1 STATION NO	Used to set the station No. <Setting range> 0 to 31 x10 Used to set the tens digit of the station No. x1 Used to set the units digit of the station No.																																														
③	Mode setting switch CH1 CH2 MODE	Used to set mode <table border="1"> <thead> <tr> <th>Mode</th> <th>Description</th> </tr> </thead> <tbody> <tr> <td>0</td> <td>When CH1 and CH2 are operated in interlock mode. Set to 0 (for CH1). Set to one of 0 to 6 (for CH2). When CH1 and CH2 are operated independently. Setting disabled.</td> </tr> <tr> <td>1</td> <td rowspan="5">Dedicated protocol</td> <td>Format 1</td> </tr> <tr> <td>2</td> <td>Format 2</td> </tr> <tr> <td>3</td> <td>Format 3</td> </tr> <tr> <td>4</td> <td>Format 4</td> </tr> <tr> <td>5</td> <td>Format 5</td> </tr> <tr> <td>6</td> <td>Modeless protocol</td> <td></td> </tr> <tr> <td>7</td> <td>Bidirectional protocol</td> <td></td> </tr> <tr> <td>8 to D</td> <td>Setting disabled</td> <td></td> </tr> <tr> <td>E</td> <td>ROM/RAM/switch test</td> <td></td> </tr> <tr> <td>F</td> <td>Wrap test</td> <td></td> </tr> </tbody> </table>	Mode	Description	0	When CH1 and CH2 are operated in interlock mode. Set to 0 (for CH1). Set to one of 0 to 6 (for CH2). When CH1 and CH2 are operated independently. Setting disabled.	1	Dedicated protocol	Format 1	2	Format 2	3	Format 3	4	Format 4	5	Format 5	6	Modeless protocol		7	Bidirectional protocol		8 to D	Setting disabled		E	ROM/RAM/switch test		F	Wrap test																	
Mode	Description																																															
0	When CH1 and CH2 are operated in interlock mode. Set to 0 (for CH1). Set to one of 0 to 6 (for CH2). When CH1 and CH2 are operated independently. Setting disabled.																																															
1	Dedicated protocol	Format 1																																														
2		Format 2																																														
3		Format 3																																														
4		Format 4																																														
5		Format 5																																														
6	Modeless protocol																																															
7	Bidirectional protocol																																															
8 to D	Setting disabled																																															
E	ROM/RAM/switch test																																															
F	Wrap test																																															
④	Communications parameter setting switch SW01 SW02 SW03 SW04 SW05 SW06 SW07 SW08 SW09 to SW12 SW13 to SW15	Used to set the following communications parameters <table border="1"> <thead> <tr> <th rowspan="2">Switch No.</th> <th rowspan="2">Description</th> <th colspan="2">State</th> </tr> <tr> <th>OFF</th> <th>ON</th> </tr> </thead> <tbody> <tr> <td>SW01 *1</td> <td>Operation mode</td> <td>Independent</td> <td>Continuance</td> </tr> <tr> <td>SW02</td> <td>Data bit</td> <td>7 bits</td> <td>8 bits</td> </tr> <tr> <td>SW03</td> <td>Parity bit</td> <td>No</td> <td>Yes</td> </tr> <tr> <td>SW04</td> <td>Parity (even/odd)</td> <td>Odd</td> <td>Even</td> </tr> <tr> <td>SW05</td> <td>Stop bit</td> <td>1 bit</td> <td>2 bits</td> </tr> <tr> <td>SW06</td> <td>Sum check</td> <td>No</td> <td>Yes</td> </tr> <tr> <td>SW07</td> <td>Writing during operation</td> <td>Disabled</td> <td>Enabled</td> </tr> <tr> <td>SW08</td> <td>Setting change</td> <td>Disabled</td> <td>Enabled</td> </tr> <tr> <td>SW09 to SW12</td> <td>Baud rate</td> <td colspan="2">Refer to *2</td> </tr> <tr> <td>SW13 to SW15</td> <td></td> <td colspan="2">(Set all the switches to OFF)</td> </tr> </tbody> </table>	Switch No.	Description	State		OFF	ON	SW01 *1	Operation mode	Independent	Continuance	SW02	Data bit	7 bits	8 bits	SW03	Parity bit	No	Yes	SW04	Parity (even/odd)	Odd	Even	SW05	Stop bit	1 bit	2 bits	SW06	Sum check	No	Yes	SW07	Writing during operation	Disabled	Enabled	SW08	Setting change	Disabled	Enabled	SW09 to SW12	Baud rate	Refer to *2		SW13 to SW15		(Set all the switches to OFF)	
Switch No.	Description	State																																														
		OFF	ON																																													
SW01 *1	Operation mode	Independent	Continuance																																													
SW02	Data bit	7 bits	8 bits																																													
SW03	Parity bit	No	Yes																																													
SW04	Parity (even/odd)	Odd	Even																																													
SW05	Stop bit	1 bit	2 bits																																													
SW06	Sum check	No	Yes																																													
SW07	Writing during operation	Disabled	Enabled																																													
SW08	Setting change	Disabled	Enabled																																													
SW09 to SW12	Baud rate	Refer to *2																																														
SW13 to SW15		(Set all the switches to OFF)																																														

*1 Switch for CH1 must be set to OFF. Switch for CH2 can be set to either ON or OFF.

*2 Baud rate

Baud rate (BPS)	300	600	1200	2400	4800	9600	19200
SW09	OFF	ON	OFF	ON	OFF	ON	OFF
SW10	OFF	OFF	ON	ON	OFF	OFF	ON
SW11	OFF	OFF	OFF	OFF	ON	ON	ON
SW12	OFF	OFF	OFF	OFF	OFF	OFF	OFF

No.	Name	Description
⑤	RS-422 interface	Used to connect the equipment to external device.
⑥	RS-422/485 interface	Used to connect the equipment to external device.

6.2.2 Wrap Test

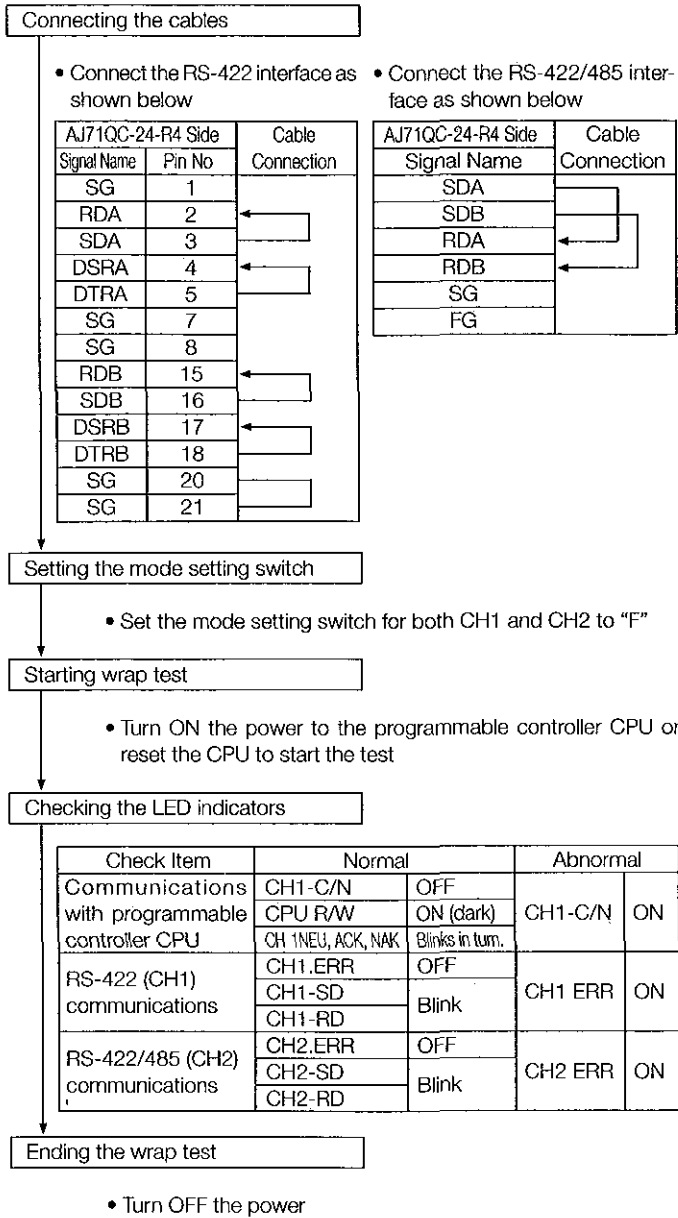

After the test is complete, change the mode setting switch to enable data transfer with the external device
 (Make sure that the mode setting switch for the interface via which data transfer is not to be carried out is set to one of 1 to 7)

7.1 Connecting the RS-422 Interface (CH1)

(1) An example for DC code control or DTR/DSR control

AJ71QC-24-R4 Side		Connection and Signal Direction (Example)	External Device	
Signal Name	Pin No		Signal Name	Terminator position
SG	1	→	SG	
RDA	2	←	SDB	
RDB	15	←	SDA	
SDA	3	→	RDB	□ R
SDB	16	→	RDA	
DSRA	4	←	DTRB	
DSRB	17	←	DTRA	
DTRA	5	→	DSRB	□ R
DTRB	18	→	DSRA	
SG	7	←	SG	
SG	8	←	SG	
SG	20	←	SG	
SG	21	←	SG	

(2) An example for DC code control

AJ71QC-24-R4 Side		Connection and Signal Direction (Example)	External Device	
Signal Name	Pin No		Signal Name	Terminator position
SG	1	→	SG	
RDA	2	←	SDB	
RDB	15	←	SDA	
SDA	3	→	RDB	□ R
SDB	16	→	RDA	
DSRA	4	←	DTRB	
DSRB	17	←	DTRA	
DTRA	5	→	DSRB	□ R
DTRB	18	→	DSRA	
SG	7	←	SG	
SG	8	←	SG	
SG	20	←	SG	
SG	21	←	SG	

7.2 Connecting the RS-422 /485 Interface (CH2)

Typical connecting method for the RS-422/485 interface is described below

AJ71QC-24-R4 Side		Connection and Signal Direction (Example)	External Device	
Signal Name	Pin No		Signal Name	Terminator position
SDA		→	RDA	
SDB		→	RDB	
RDA		←	SDA	
RDB		←	SDB	
			RSA	
			RSB	
			CSA	
			CSB	
NC				
SG		←	SG	
FG		←	FG	

7.3 Connecting the Terminators (Required for CH2 only)

If the equipment is used as the first or last station in the network, install a terminator as follows. If no terminator is installed, problems may result during data transfer.

The terminators to be connected vary according to the type of interface, as shown below.

- RS-422 330Ω
- RS-485 110Ω

(1) One to one connection (one external device to one AJ71QC24-R4)

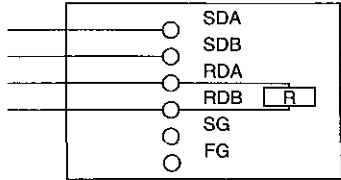

Install a terminator between RDA and RDB

(2) 1 to n connection (one external device to n pieces of AJ71QC24-R4)

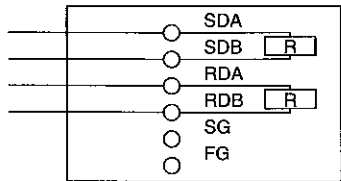

Install a terminator between SDA and SDB as well as between RDA and RDB

(3) m to n connection (m pieces of external device to n pieces of AJ71QC24-R4)

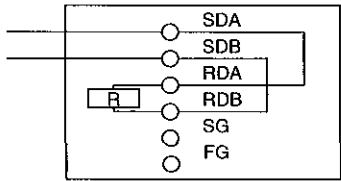

Install a terminator between RDA and RDB

7.4 Installing the RS-422/485 Interface Terminal Block

The RS-422/485 interface (CH2) accommodates a two-piece type terminal block, to enable replacement of the unit without having to remove the signal lines.

The method of mounting the terminal block is illustrated below.

