

MELSEC A Series

Programmable Logic Controllers

User's Manual

Profibus/DP Interface Modules AJ71PB92D, A1SJ71PB92D

● SAFETY PRECAUTIONS ●

(Read these precautions before using.)

When using Mitsubishi equipment, thoroughly read this manual and the associated manuals introduced in this manual. Also pay careful attention to safety and handle the module properly.

These precautions apply only to Mitsubishi equipment. Refer to the CPU module user's manual for a description of the PLC system safety precautions.

These ● SAFETY PRECAUTIONS ● classify the safety precautions into two categories: "DANGER" and "CAUTION".



DANGER

Procedures which may lead to a dangerous condition and cause death or serious injury if not carried out properly.



CAUTION

Procedures which may lead to a dangerous condition and cause superficial to medium injury, or physical damage only, if not carried out properly.

Depending on circumstances, procedures indicated by  **CAUTION** may also be linked to serious results. In any case, it is important to follow the directions for usage.

Store this manual in a safe place so that you can take it out and read it whenever necessary. Always forward it to the end user.

[DESIGN PRECAUTIONS]

DANGER

- When a communication error occurs in the PROFIBUS network, the status of the faulty station is as follows. Configure an interlock circuit in the sequence program using the communication status information (input X1, buffer memory 2040 to 2079) so that the system can operate safely. Erroneous outputs and mis-operation could cause accidents.
 - (1) The input data of the master station maintains the data before abnormality of the communication.
 - (2) When the master station is down, the output state of each slave station will be in accordance with the parameter settings.
 - (3) When any slave station is down, the output state of other slave stations will be in accordance with the parameter settings of the master station.
- If a stop error occurs in the CPU module, the communication status is as described below.
 - (1) Communication with the slave station is stopped.
 - (2) For the input data received from the slave station, the values at CPU module stop error occurrence are held.
 - (3) The output data sent from the AJ71PB92D/A1SJ71PB92D to the slave station are cleared.

CAUTION

- When the PROFIBUS cable is laid, do not lay it close to main circuits or power lines. They should be installed 100mm(3.9inch) or more from each other. Not doing so could result in noise that would cause malfunctioning.

[INSTALLATION PRECAUTIONS]

CAUTION

- Use the module in the environment given in the general specifications of the CPU module's User's Manual. Using the module outside the range of the general specifications may result in electric shock, fire or malfunctioning, or may damage or degrade the module.
- Insert the tabs at the bottom of the module into the mounting holes in the base unit before installing the module. (The AnS series module shall be fastened by screws in the base unit at the specified torque.) Not installing the module correctly could result in malfunctioning, breakdowns or pieces of the product falling
- Tighten the fixing screws of the PROFIBUS cable with the specified torque. If the screws are loose, it could result in malfunction of the module.
- Do not touch the conductive area or electric parts of the module. Doing so may cause module malfunctioning or breakdowns.

[WIRING PRECAUTIONS]

CAUTION

- Switch all phases of the external power supply of the PLC system off before connecting the PROFIBUS cable. Not doing so could cause failure or malfunctioning of the module.
- Be careful not to let foreign matter such as filings or wire chips get inside the module. These can cause fire, breakdowns and malfunctioning.
- The PROFIBUS cable which is connected to the module must be protected with a duct or secured in position with clamps.
Unless the cable is thus protected or secured, the module or the cable could be damaged when the cable swings, moves or it is strained with careless pulls, or it could cause malfunction when the cable contacts with any undesirable objects.
- When disconnecting the PROFIBUS cable from the module, do not pull by holding the cable section. To disconnect the cable, make sure to hold the connector which is coupled with the module. Do not attempt to pull the cable to disconnect it from the module. It could damage the module or the cable, or cause malfunction due to a poor contact of the cable.

[STARTING AND MAINTENANCE PRECAUTIONS]

DANGER

- Switch all phases of the external power supply off before cleaning.
Not doing so could cause electric shock.

 **CAUTION**

- Never disassemble or modify the module.
This may cause breakdowns, malfunctioning, injury and/or fire.
- Switch all phases of the external power supply off before mounting or removing the module. If you do not switch off the external power supply, it will cause breakdowns or malfunction of the module.
- Set the ON/OFF select switch of the terminal resistor before the operation.
If the setting is switched during the operation, network error may occur, or error detection may not be performed by error.
- Before handling the module, always touch grounded metal, etc. to discharge static electricity from the human body.
Failure to do so can cause the module to fail or malfunction.

[OPERATING PRECAUTIONS]

 **DANGER**

- Do not write data into the "not usable" of the buffer memory of special function modules. Also, do not output the "not usable" signal as the output signal to a special function module from the PLC CPU. Writing data into the "not usable area" or outputting an "not usable" signal may cause system malfunctions in the PLC.

 **CAUTION**

- The online operations conducted for the CPU module being operated (especially when changing data or operation status), shall be conducted after the manual has been carefully read and a sufficient check of safety has been conducted.
Operation mistakes could cause breakdowns to or malfunction of the module.

[DISPOSAL PRECAUTIONS]

 **CAUTION**

- When disposing of this product, treat it as industrial waste.

Revisions

* The manual number is noted at the lower left of the back cover.

Print Date	*Manual Number	Revision
May, 1997	IB (NA)-66773-A	First printing
Sep., 1997	IB (NA)-66773-B	<div style="border: 1px solid black; display: inline-block; padding: 2px;">Correction</div> Section 2.3, Chapter 3 <div style="border: 1px solid black; display: inline-block; padding: 2px;">Addition</div> Appendix 2
Oct., 1998	IB (NA)-66773-C	<div style="border: 1px solid black; display: inline-block; padding: 2px;">Model Addition</div> AJ71PB92D <div style="border: 1px solid black; display: inline-block; padding: 2px;">Correction</div> SAFTY PRECAUTIONS, Chapter 1, 2, 3, 4, Section 5.1, 5.2, 5.3, 5.5.1, 5.5.2, 5.6, 6.1, Chapter 7, 8, 9 <div style="border: 1px solid black; display: inline-block; padding: 2px;">Addition</div> Appendix 1 <div style="border: 1px solid black; display: inline-block; padding: 2px;">Chapter Alteration</div> Appendix 1 → Appendix 3
Jun., 2000	IB (NA)-66773-D	<div style="border: 1px solid black; display: inline-block; padding: 2px;">Correction</div> Chapter 1, Section 2.1, 2.2, 2.3, 2.4, 2.5, 3.1, 3.2, 4.2.1, 4.2.2, 4.3.1, 5.5.1, Appendix 1 <div style="border: 1px solid black; display: inline-block; padding: 2px;">Addition</div> Section 2.6, 4.4, 4.5, 8.6
Jun., 2003	IB (NA)-66773-E	<div style="border: 1px solid black; display: inline-block; padding: 2px;">Correction</div> SAFTY PRECAUTIONS, Section 4.3.2, 6.1, 8.2.1, 8.2.2 <div style="border: 1px solid black; display: inline-block; padding: 2px;">Addition</div> Section 3.3.3, Appendix 2
Apr., 2004	IB (NA)-66773-F	<div style="border: 1px solid black; display: inline-block; padding: 2px;">Correction</div> Section 1.2, 3.2, 3.3.3, 4.2.2, 4.3.1, 4.3.2, 4.6, 5.1, 5.3, 6.1, 6.2 <div style="border: 1px solid black; display: inline-block; padding: 2px;">Addition</div> SAFTY PRECAUTIONS, Chapter 9
Aug., 2004	IB (NA)-66773-G	<div style="border: 1px solid black; display: inline-block; padding: 2px;">Correction</div> SAFTY PRECAUTIONS, Section 2.2, 3.3.2, 3.3.3, 4.3.2, 5.5.1, Chapter 8, Section 8.2.2

Japanese Manual Version SH-3330-G

This manual does not imply guarantee or implementation right for industrial ownership or implementation of other rights. Mitsubishi Electric Corporation is not responsible for industrial ownership problems caused by use of the contents of this manual.

Introduction

Thank you for purchasing the Mitsubishi Programmable Controller MELSEC-A Series.

Before using the equipment, please read this manual carefully to develop full familiarity with the functions and performance of the graphic operation terminal you have purchased, so as to ensure correct use.

Please forward a copy of this manual to the end user.

Table of Contents

About This Manual	
1. OVERVIEW 1-1 to 1-2	
1.1 Software Configuration.....	1- 1
1.2 AJ71PB92D/A1SJ71PB92D Features	1- 2
2. SYSTEM CONFIGURATION 2-1 to 2-6	
2.1 Whole System Configuration	2- 1
2.2 System Configuration Example.....	2- 2
2.3 Applicable CPU Modules	2- 3
2.4 Installable Base Units	2- 4
2.5 Combining with MELSECNET (II), MELSECNET/B, and MELSECNET/10.....	2- 4
2.6 Precautions for Configuring a System	2- 5
3. SPECIFICATIONS 3-1 to 3-10	
3.1 General Specification.....	3- 1
3.2 Performance Specifications	3- 2
3.3 Network Configuration.....	3- 3
3.3.1 Basic configuration	3- 3
3.3.2 Applicable configuration.....	3- 4
3.3.3 Number of connectable slaves	3- 8
4. FUNCTIONS 4-1 to 4-32	
4.1 Functions for Exchanging with Slaves	4- 1
4.1.1 Exchange flow.....	4- 1
4.1.2 Global control functions	4- 2
4.2 I/O Signal	4- 5
4.2.1 I/O signal list.....	4- 5
4.2.2 I/O signal detail description.....	4- 6
4.3 Buffer Memory List.....	4- 9
4.3.1 Buffer memory/configuration.....	4- 9
4.3.2 Buffer memory detailed description	4-10
4.4 While-Run Operation Mode Changing Function	4-30
4.5 AJ71PB92D/A1SJ71PB92D's Remote Parameter Setting Function Using MELSEC ProfiMap Configuration Software.....	4-31
4.6 E ² PROM initialization function	4-32
5. PROCEDURES BEFORE SYSTEM OPERATION 5-1 to 5-10	
5.1 Procedures before Operation.....	5- 1
5.1.1 Parameter setting procedure	5- 2
5.2 Handling Precautions.....	5- 3
5.3 Part Names and Settings	5- 4

5.4	Execution Method for Self-diagnosis.....	5- 6
5.5	Wiring.....	5- 7
5.5.1	PROFIBUS cable wiring.....	5- 7
5.5.2	Terminator switch	5- 7
5.5.3	Precautions against wiring.....	5- 8
5.6	Maintenance and Inspection	5-10

6. COMMUNICATION TIME	6-1 to 6-4
------------------------------	-------------------

6.1	Transmission Delay Time When There is One Master Station	6- 1
6.2	Transmission Delay Time When There are Multiple Master Stations	6- 4

7. DDB FILE	7-1 to 7-2
--------------------	-------------------

8. PROGRAMMING	8-1 to 8-6
-----------------------	-------------------

8.1	Initial Program.....	8- 1
8.2	Data I/O with Slave	8- 2
8.2.1	Normal service mode (MODE switch : No. 0)	8- 2
8.2.2	Extend service mode (MODE switch : No. E)	8- 3
8.3	Communication Trouble Area and Expansion Communication Trouble Area Clear	8- 4
8.4	Address Information Read	8- 4
8.5	Global Control	8- 5
8.6	While-Run Operation Mode Changing	8- 6

9. TROUBLESHOOTING	9-1 to 9-2
---------------------------	-------------------

APPENDIX	A-1 to A-10
-----------------	--------------------

Appendix 1	Differences between AJ71PB92D/A1SJ71PB92D Software Versions	A- 1
Appendix 1.1	Differences between A1SJ71PB92D Software Versions.....	A- 1
Appendix 1.2	Restrictions on Use of A1SJ71PB92D Software Versions in the Same System	A- 2
Appendix 1.3	Differences between AJ71PB92D Software Versions	A- 2
Appendix 1.4	Restrictions on Use of AJ71PB92D Software Versions in the Same System	A- 2
Appendix 2	Precautions for Replacing AJ71PB92 with A(1S)J71PB92D	A- 3
Appendix 3	Extended Trouble Information of Mitsubishi's Slaves	A- 7
Appendix 4	External Dimensions.....	A- 8

About This Manual

The following are manuals related to this product.

Request for the manuals as needed according to the chart below.

Related Manual

Manual Name	Article No.
MELSEC ProfiMap Configuration System for Open Networks Software Manual	65778-B

- * Inquiries can be made to :
MITSUBISHI ELECTRIC EUROPE Factory Automation
Gothaer Strasse 8 D-40880 Ratingen Germany
Phone : +49(21 02)486-0
Fax : +49(21 02)486-717

1. OVERVIEW

This is the user's manual for the AJ71PB92D/A1SJ71PB92D PROFIBUS-DP interface module (hereafter abbreviated as "AJ71PB92D/A1SJ71PB92D). When explain separately, however, abbreviated as AJ71PB92D, A1SJ71PB92D), which is used to connect a MELSEC-A/QnA/Q series programmable controller to a PROFIBUS-DP network.

The AJ71PB92D/A1SJ71PB92D operates as a master station (class 1) in the PROFIBUS-DP network.

1.1 Software Configuration

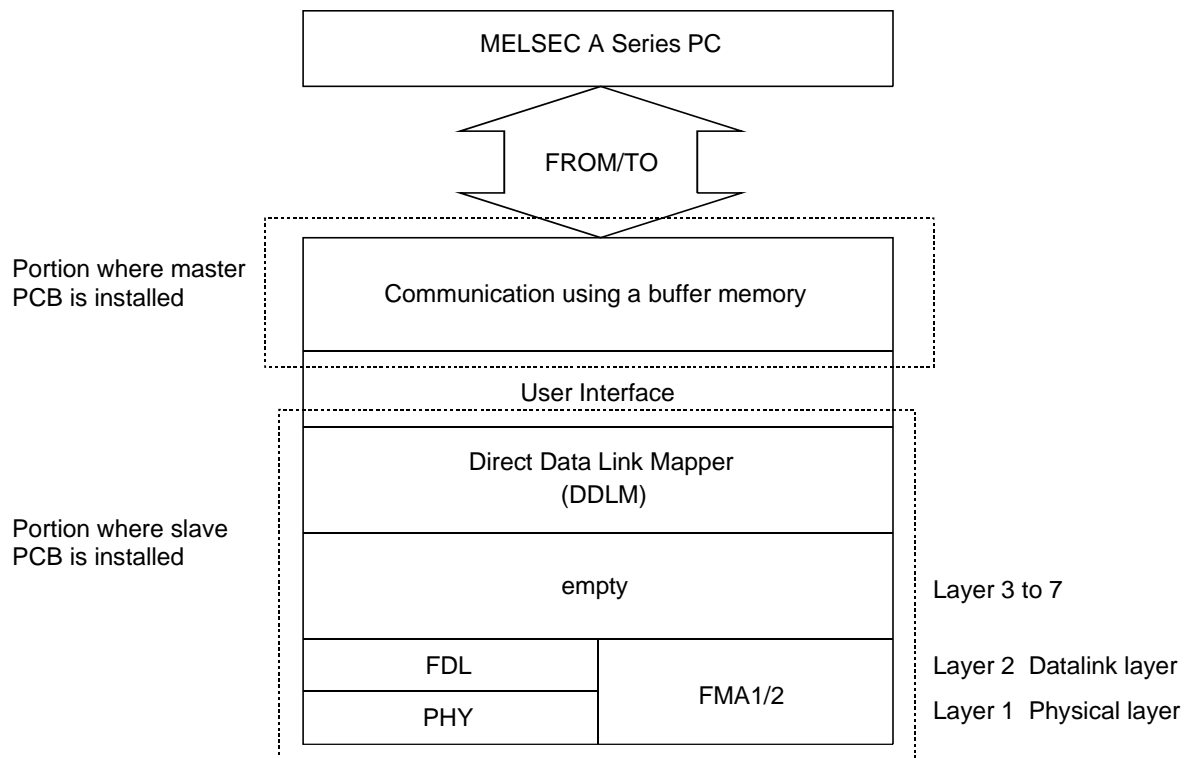

The AJ71PB92D/A1SJ71PB92D has a physical layer, data link layer, DDLM, and user interface that conform to PROFIBUS-DP, and communicates data with the PLC CPU by using a buffer memory. The main application of PROFIBUS-DP is networks that execute high-speed communication at the level of sensors and actuators, and the AJ71PB92D/A1SJ71PB92D has been designed with this in mind: its functions are mainly related to data I/O with slave stations.

1.2 AJ71PB92D/A1SJ71PB92D Features

- (1) Operates as a PROFIBUS-DP master (class 1) station.
- (2) Makes possible the exchange of input and output data to and from the slave station without the need to be aware of the PROFIBUS-DP protocol by using I/O signals X/Y and the buffer memory.
- (3) Supports 3M, 6M, 12M [bps] network communication speeds in addition to the 9.6k, 19.2k, 93.75k, 187.5k, 500k, and 1.5M [bps] supported by the AJ71PB92D/A1SJ71PB92D. These can be selected using a configurator.
- (4) Station Nos. from 0 to 125 can be set using the configurator.
- (5) Trouble information can be read from the slave station using the I/O signal X/Y and the buffer memory.
- (6) The global control function makes it possible to maintain all slave I/O at the same time. In addition, this can also be canceled.
- (7) The module contains a self-diagnosis function that can be used to test the hardware such as the internal memory.

2. SYSTEM CONFIGURATION

This section explains system configuration for the AJ71PB92D/A1SJ71PB92D

2.1 Whole System Configuration

(1) For the A1SJCPU

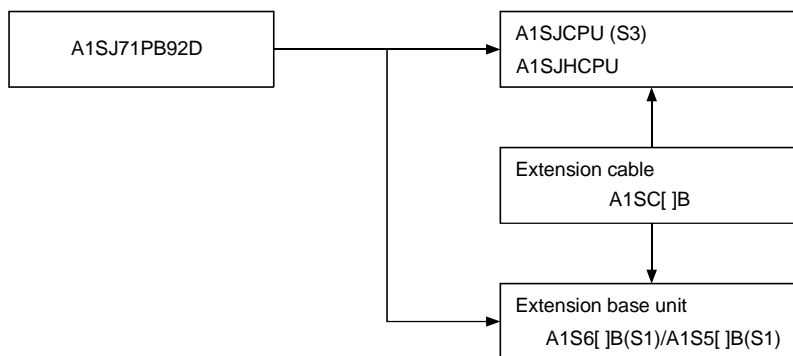

(2) For the compact building block type CPU

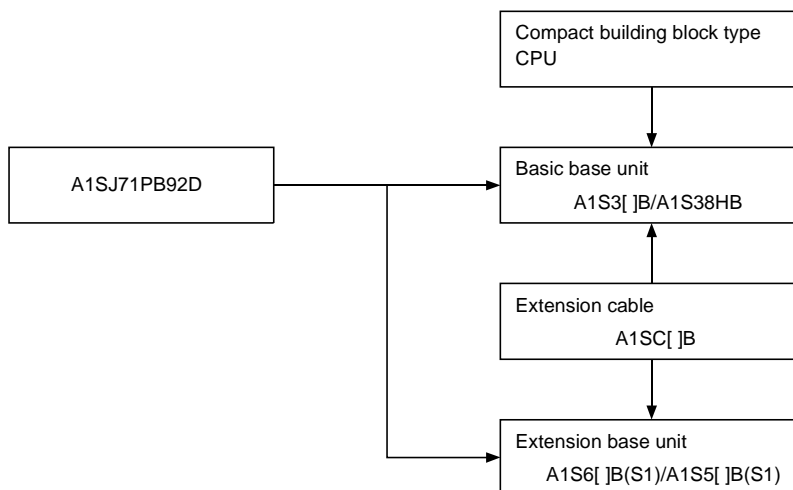

(3) For the building block type CPU

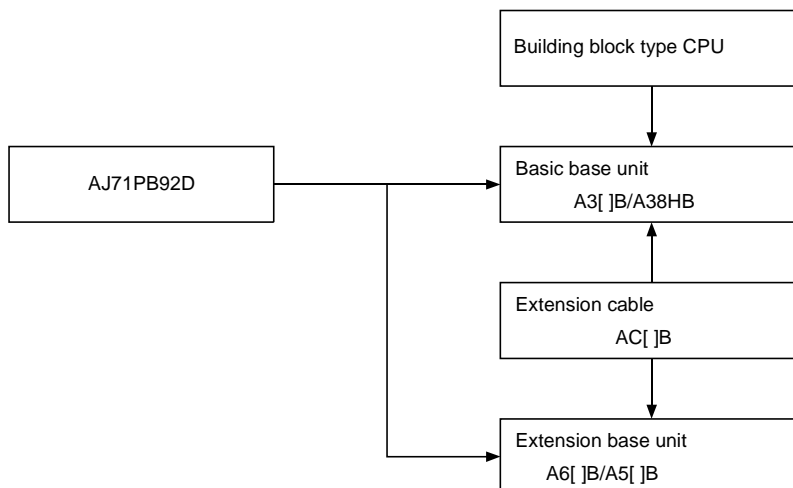

(4) For the Q series CPU

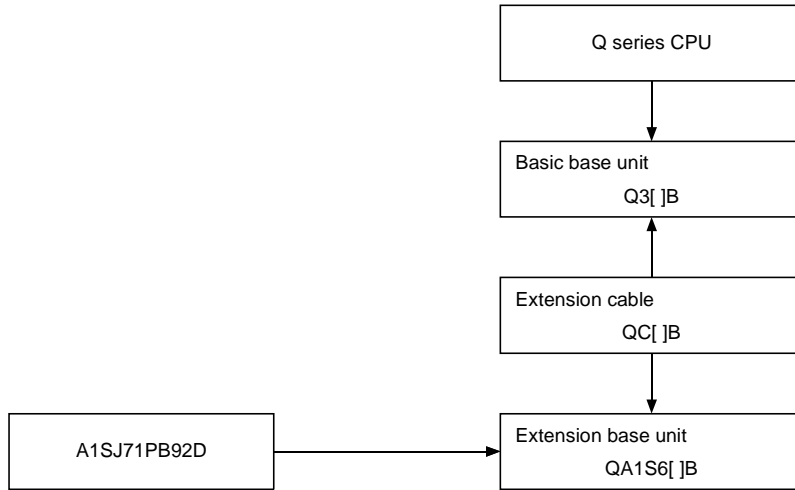

2.2 System Configuration Example

The following describes the A1SJ71PB92D system configuration example. A communication parameter file is created in Windows using the Configurator software package, this parameter file can then be down-loaded via an RS-232C cable to the AJ71PB92D/A1SJ71PB92D.

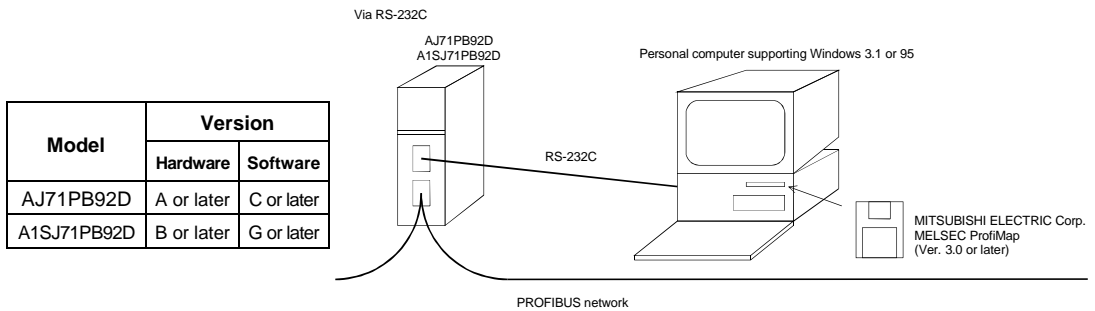

Point Refer to "About This Manual" for inquiry for MELSEC ProfiMap.

*: Version confirmation method of AJ71PB92D/A1SJ71PB92D

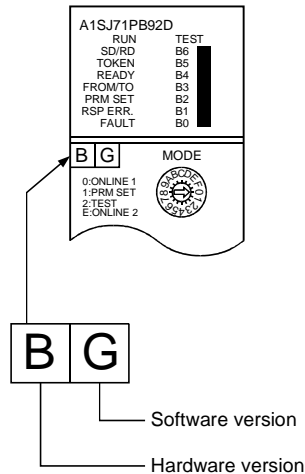

2.3 Applicable CPU Modules

The following table shows the CPUs that the AJ71PB92D/A1SJ71PB92D can use.

(1) AJ71PB92D

Applicable CPU Modules
A1SCPUC24-R2
A1SJHCPU, A1SHCPU, A2SHCPU, A2SHCPU-S1, A1NCPUR21, A1NCPUP21, A1NCPUP21-S3, A1NCPUR21, A2NCPUR21, A2NCPUP21, A2NCPUP21-S3, A2NCPUR21, A2NCPUR21-S1, A2NCPUP21-S1, A2NCPUP21-S4, A2NCPUR21, A3NCPUR21, A3NCPUP21, A3NCPUP21-S3, A3NCPUR21
A2ASCPUR21, A2ASCPUS1, A2ASCPUS30, A2USHCPUS1 A2ACPU, A2ACPUP21, A2ACPUP21-S3, A2ACPUR21, A2ACPU-S1, A2ACPUP21-S1, A2ACPUP21-S4, A2ACPUR21, A3ACPU, A3ACPUP21, A3ACPUP21-S3, A3ACPUR21, A2UCPU, A2UCPUS1, A3UCPU, A4UCPU
Q2ASCPUR21, Q2ASCPUS1, Q2ASHCPUR21, Q2ASHCPUS1, Q2ACPU, Q2ACPU-S1, Q3ACPU, Q4ACPU, Q4ARCPU

(2) A1SJ71PB92D

Applicable CPU Modules
A1SCPUC24-R2
A1SJHCPU, A1SHCPU, A2SHCPU, A2SHCPU-S1
A2ASCPUR21, A2ASCPUS1, A2ASCPUS30, A2USHCPUS1
Q2ASCPUR21, Q2ASCPUS1, Q2ASHCPUR21, Q2ASHCPUS1
Q02HCPUR21, Q02HCPUS1, Q06HCPUR21, Q06HCPUS1

2.4 Installable Base Units

The base modules that can be installed in the AJ71PB92D/AISJ71PB92D are shown below.

(1) AJ71PB92D

Installable Base Units	
Basic base unit	Extension base unit
A32B, A32B-S1, A35B, A38B, A38HB	A52B, A55B, A58B, A62B, A65B, A68B

(2) A1SJ71PB92D

Installable Base Units	
Basic base unit	Extension base unit *1
A1S32B, A1S33B, A1S35B, A1S38B, A1S38HB	A1S52B (S1), A1S55B (S1), A1S58B (S1), A1S65B (S1), A1S68B (S1), QA1S65B, QA1S68B

*1: The no power supply module extension base unit A1S5 [] B (S1) may not have sufficient power supply capacity, so use the A1S6 [] B (S1) when installing a AJ71PB92D/A1SJ71PB92D in the extension base unit.

When the A1S5 [] B (S1) must be installed, do so after referring to the chapter covering power supplies in the respective CPU Module User's Manual.

2.5 Combining with MELSECNET (II), MELSECNET/B, and MELSECNET/10

The AJ71PB92D/A1SJ71PB92D can be installed in the MELSECNET (II) and MELSECNET/B master stations and local stations, and in the MELSECNET/10 control stations and normal stations. However, the AJ71PB92D/A1SJ71PB92D cannot be installed in the MELSECNET (II), MELSECNET/B, and MELSECNET/10 remote stations, so be careful.

2.6 Precautions for Configuring a System

(1) There are the following restrictions on the AJ71PB92D/A1SJ71PB92D according to the applied CPU module and used configuration software.

CPU Module	Configuration Software	Parameter File Write Path		Max. I/O Data Length	
		Via AJ71PB92D/A1SJ71PB92D RS-232C interface	Via CPU module RS-232C/RS-422 interface	Normal service mode	Extended service mode
Q series CPU	SW0D5F-PROFIMAP	Write enabled	Write disabled	32 bytes each for input and output	32 bytes each for input and output
	MELSEC-PROFIMAP 2.0				244 bytes each for input and output*1
	MELSEC-PROFIMAP 3.0				
A/QnA series CPU	SW0D5F-PROFIMAP				32 bytes each for input and output
	MELSEC-PROFIMAP 2.0				244 bytes each for input and output*1
	MELSEC-PROFIMAP 3.0				Write enabled*1

*1: The software version usable by the AJ71PB92D/A1SJ71PB92D is AJ71PB92D (A or later) or A1SJ71PB92D (E or later).
 When A1SJ71PB92D (software version D or earlier) is used, write is disabled and the max. data length is 32 bytes each for input and output.

(2) Precautions for using the parameters preset for extended service mode to operate the module in normal service mode.

The following table gives the operating conditions (conditions per one slave station) for the time when the parameters preset for the extended service mode are used to operate the AJ71PB92D/A1SJ71PB92D preset for the normal service mode/extended service mode.

○ : Operable 5 : Inoperable

Operating Condition	Parameter Size		Exchange Data Length	
	122 bytes max	244 bytes max	32 bytes max	244 bytes max.
AJ71PB92D A1SJ71PB92D				
AJ71PB92D software version A or later and normal service mode setting	○	○	○	5
A1SJ71PB92D software version E or later and normal service mode setting	○	○	○	5
A1SJ71PB92D software version D or earlier and extended service mode setting	○	5	○	5

(3) In either of the following cases, the AJ71PB92D/A1SJ71PB92D buffer memory must be accessed by a sequence program when the module ready signal X1D of the AJ71PB92D/A1SJ71PB92D is ON.

- The operation mode is changed using Y11/X11 in the sequence program.
- Parameter setting is made with ProfiMap connected to other than the RS-232C port of the AJ71PB92D/A1SJ71PB92D. (For example, parameter setting is made with ProfiMap connected to the RS-422/RS-232 connector of the CPU module.)

If the buffer memory is accessed with the X1D status ignored, the CPU module may detect the "SP UNIT DOWN" error, stopping the sequence operation.

(4) Do not make parameter setting via buffer memory and parameter setting from the RS-232C port of the AJ71PB92D/A1SJ71PB92D at the same time.

If they are made simultaneously, ProfiMap which started parameter write earlier wins the parameter write right after the operation mode is changed to the parameter setting mode, and the other ProfiMap cannot perform parameter write and detects an error.

This status will be automatically cleared 15 seconds after completion of parameter write if parameter write via the CPU module is valid, or 3 seconds after completion of parameter write if parameter write from RS-232C is valid.

(5) Do not make simultaneous access to the AJ71PB92D/A1SJ71PB92D from multiple ProfiMap's.

If such access is made, the AJ71PB92D/A1SJ71PB92D may not be accessed properly.

(6) If remote parameter setting is performed from MELSEC ProfiMap to the AJ71PB92D/A1SJ71PB92D which is making data exchange, note that PROFIBUS data exchange will stop during parameter setting.

(7) In a system where remote parameter setting is made from MELSEC ProfiMap, do not execute the mode changing function using the program.

If the mode changing function is executed in the program, an interlock with the remote parameter setting is not provided and therefore the mode may not be changed.

3. SPECIFICATIONS

This section explains the AJ71PB92D/A1SJ71PB92D the general specifications, performance specifications, and transmission specifications.

3.1 General Specification

This section explains the AJ71PB92D/A1SJ71PB92D general specifications.

Table 3.1 General Specification

Item	Specification				
Usage environment temperature	0 to 55°C				
Storage environment temperature	-20 to 75°C				
Usage environment humidity	10 to 90%RH, No condensation formation				
Storage environment humidity	10 to 90%RH, No condensation formation				
Anti-vibration	Complies with JIS B3501, IEC61131-2	When there is intermittent vibration			10 times in each direction for X, Y, Z (80 minutes)
		Frequency	Acceleration	Amplitude	
		10 to 57Hz	—	0.075mm (0.003in.)	
		57 to 150Hz	9.8m/s ²	—	
		Where there is continuous vibration			
		10 to 57Hz	—	0.035mm (0.001in.)	
57 to 150Hz	4.9m/s ²	—			
Anti-shock	Complies with JIS B3501, IEC61131-2 (147m/s ² , 3 times in the direction for each of X, Y, Z)				
Usage environment	No corrosive gas, etc.				
Usage altitude	2000m or less				
Installation location	Inside the control panel				
Over voltage category ^{*1}	II or less				
Pollution level ^{*2}	2 or less				
Cooling method	Self cooling				

*1 Shows if an estimate has been made for which distribution areas the connections will be done for the equipment from the public power grid to the equipment installation area inside the configuration.

Category II applies to equipment that receives its power from fixed facilities. The surge resistance voltage for equipment rated to 300V is 2500V

*2 Shows the index for inductive matter generation in the environment in which the equipment is used. Pollution level 2 is for dirt that is non-inductive. However, occasionally inductance can be generated in the environment by condensation.

3.2 Performance Specifications

Item		Specifications			
Model		AJ71PB92D		A1SJ71PB92D	
Transmission specifications	Electrical standards and characteristics	Complies with EIA-RS485			
	Medium	Shielded twisted cable			
	Network configuration	Bus (however, tree type when a repeater is used)			
	Data link method	<ul style="list-style-type: none"> • Token passing method (master side) • Polling method (master/slave side) 			
	Transmission encoding method	NRZ			
	Transmission speed/maximum transmission distance *1 *2	Transmission speed	Transmission distance [m/segment]	Maximum transmission distance when 3 repeaters are used [m/network]	
		9.6 [kbps]	1200	4800	
		19.2 [kbps]			
		93.75 [kbps]			
		187.5 [kbps]	1000	4000	
		500 [kbps]	400	1600	
		1.5 [Mbps]	200	800	
		3 [Mbps]	100	400	
		6 [Mbps]			
	12 [Mbps]	100 *3			
Maximum number of repeaters/network	3 units *2				
Maximum number of stations/segment	32 stations *3 (See "Point")				
Maximum number of slave stations/master station	60 slaves				
Number of connection nodes (number of repeaters)	32, 62 (1), 92 (2), 126 (3)				
Transmittable data	32 bytes/1 station (Normal service mode) 244 bytes/1 station (Extended service mode)				
Number of occupied I/O	32 points (I/O allocation : special 32 points)				
5VDC Internal current consumption	0.54 A		0.56 A		
Noise durability, dielectric withstand voltage insulation resistor	Depending on the AJ71PB92D/A1SJ71PB92D installation system power supply module specifications. (refer to the CPU Module User's Manual.)				
External dimensions	250 mm (9.84 in.)(H) × 37.5 mm (1.48 in.)(W) × 106 mm (4.17 in.)(D)		130 mm (5.12 in.)(H) × 34.5 mm (1.36 in.)(W) × 93.6 mm (3.69 in.)(D)		
Weight	0.37 kg		0.27 kg		

*1 Transmission speed control within +/- 0.3% (PROFIBUS part 1)

*2 Distance that the transmission distance can be expanded by (m/network) using repeaters
 Maximum transmission distance (m/network) = (number of repeaters + 1) × transmission distance (m/segment)

*3 The *3 restriction will cease to exist when the system is configured exclusively by the master and slave stations of the hardware version B or later versions.

Point

*3 When using 12Mbps transmission speed, restriction of the cable length and the number of connector stations described below is necessary.

- 1) Minimum length of the cable between stations is greater than or equal to one meter.
- 2) Maximum number of the connection stations are smaller than or equal to 11.

3.3 Network Configuration

3.3.1 Basic configuration

- 1) Equipment types
 - Class 1 master
 - Configurator
 - Slave
 - Repeater
- 2) Number of units that can be connected to the entire network (when repeaters are used)
Master+slave \leq 126 units
- 3) Number that can be connected for 1 segment
Master+slave+repeaters \leq 32 units
- 4) Communications can be conducted via a maximum of 3 repeaters from an arbitrary master or arbitrary slave to an arbitrary master or arbitrary slave (Not 3 units in the entire network).
- 5) The maximum number of slaves that can be connected to 1 AJ71PB92D/A1SJ71PB92D is 60 stations.

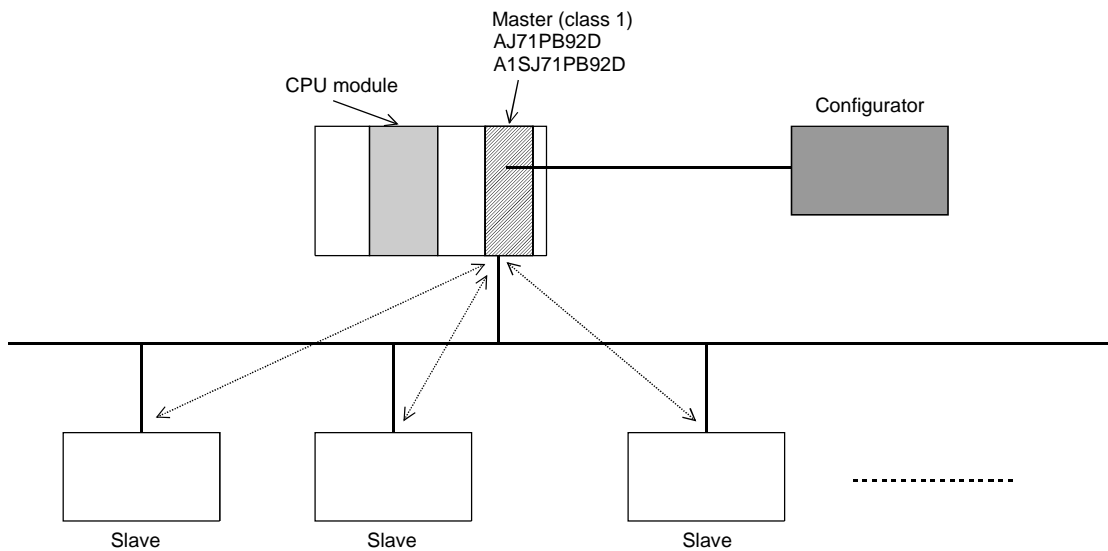

- The PROFIBUS-DP cable is provided by the user.

3.3.2 Applicable configuration

1) When 1 master (class 1) station is connected

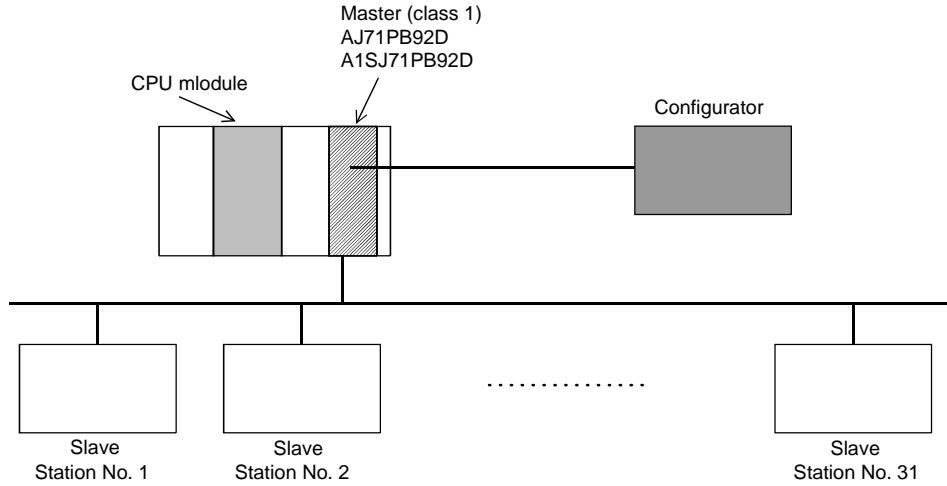

*: A maximum of 32 stations can be connected to 1 segment.

2) When 1 master (class 1) station and 1 repeater are connected

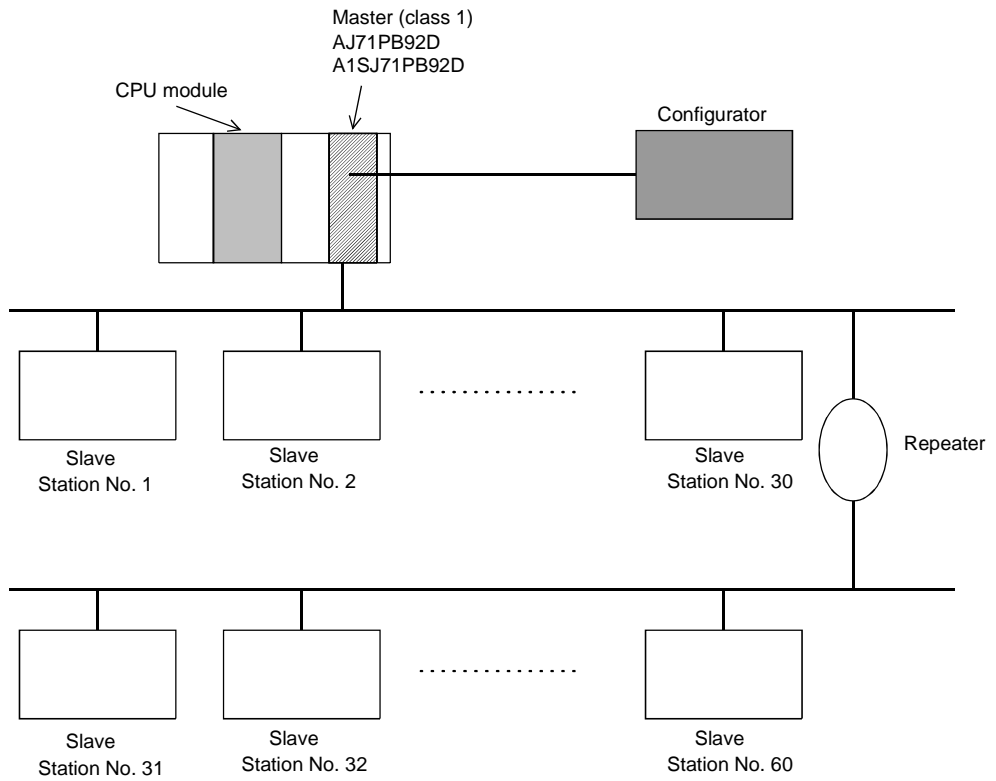

*: In the above configuration a maximum of 60 slaves can be connected.

3) When 1 master (class 1) station and 3 repeaters are connected

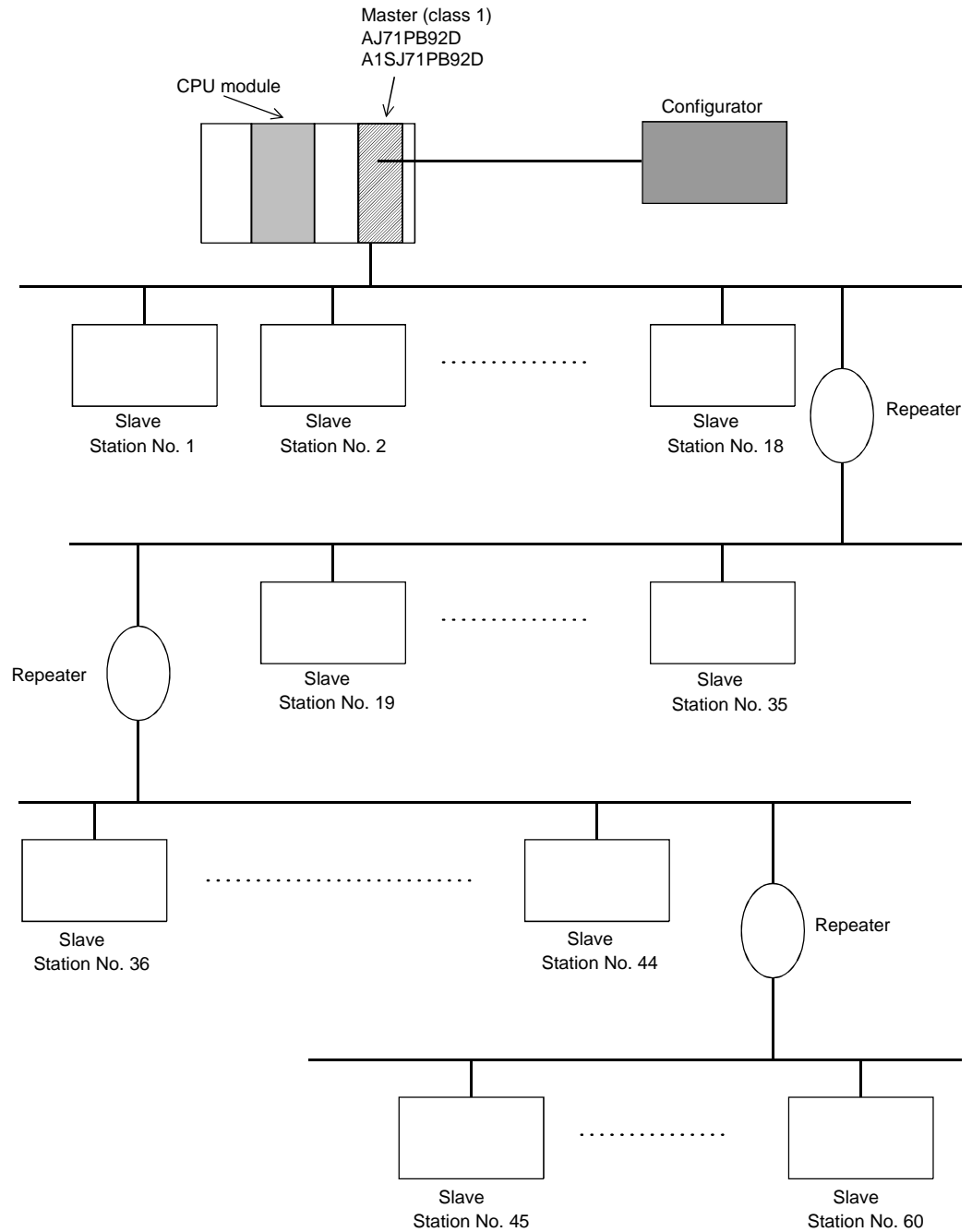

*: In the above configuration a maximum of 60 slaves can be connected. The difference between this configuration and the one in 2) is that the possible communication distance can be extended.

- 4) When 126 master (class 1) and slave stations are connected
 (When 60 or more slaves are connected)

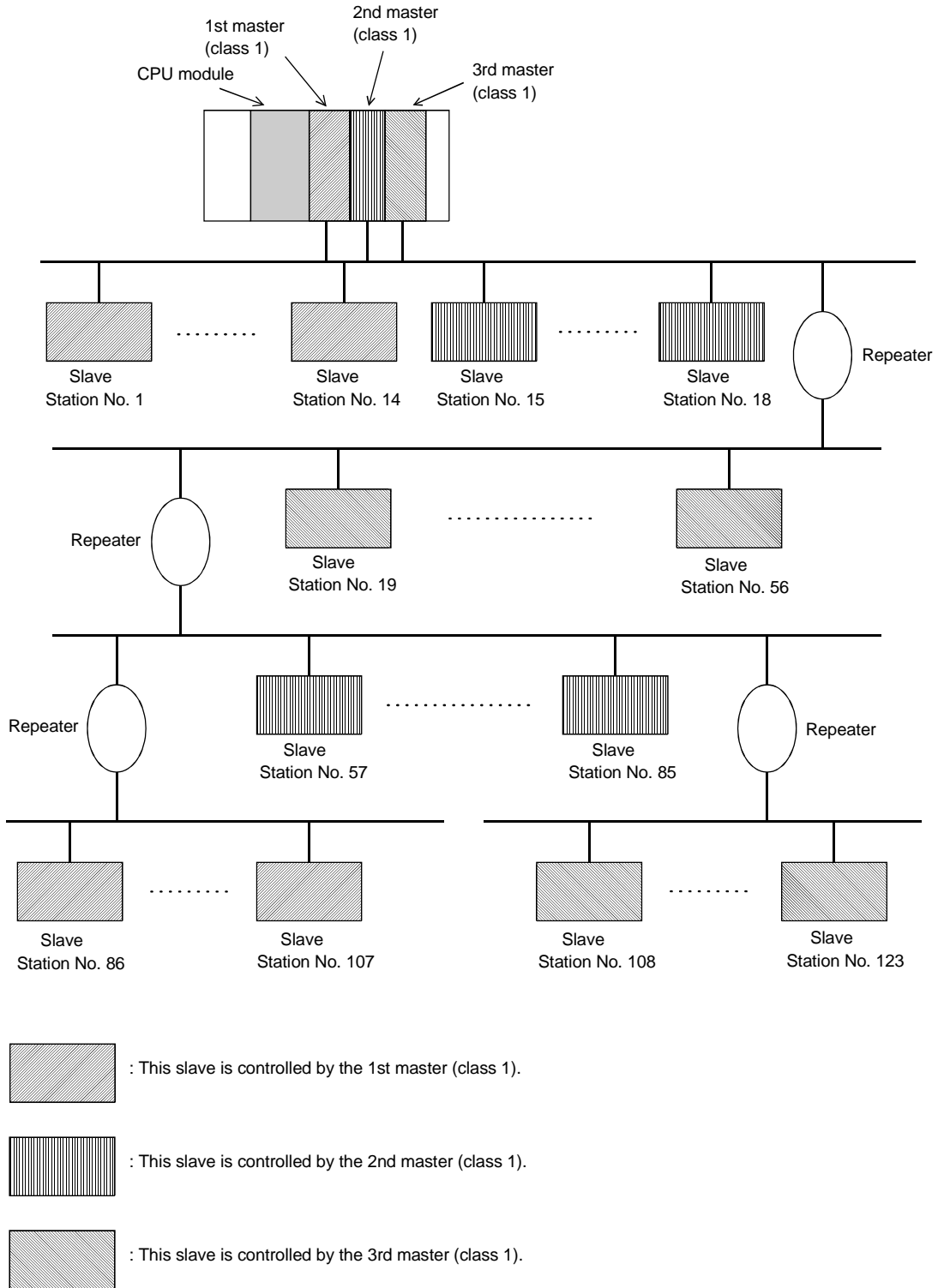

*: In the above configuration a maximum of 123 slave stations can be connected.

Point	
	<p>In configurations that use multiple master stations (multimaster configuration), when reconnecting a cable after disconnecting a PROFIBUS cable for 1 master that is exchanging data at a low baud rate, the communications of the master for which the cable is not disconnected could stop and the slave output could be turned off. To prevent this, the master PROFIBUS cable must be secured with a screw.</p> <p>In addition, there is a high possibility that the above phenomena can be avoided if care is taken with the following points when configuring a system.</p> <p>(1) Set the slave watchdog timer setting value to larger than $(T_{Tr} \times G)/BR$. However,</p> <p style="padding-left: 40px;">T_{Tr} : Target token rotation time (Unit: Bit Time) G : Gap update factor BR : Baud rate (Unit: bps)</p> <p>(2) Use a high baud rate.</p> <p>(3) The HSA (Highest Station Address) value is made to match the maximum station No. that is actually connected.</p>

3.3.3 Number of connectable slaves

Please calculate the number of the slave which can be connected under the following (1) and (2) conditions.

(1) Restrictions on maximum data length of slave station error information

The maximum data length of the slave station error information that the AJ71PB92D/A1SJ71PB92D can receive varies with the minimum station number and maximum station number of the slave stations set in the parameters, and can be calculated using the following expression.

$$\text{Maximum data length of acceptable error information [bytes]} = \text{Min} \left(\frac{12600}{N - 10}, 244 \right)$$

$$N = \text{Min}((a - b + 1) \times 5, 300)$$

a: Maximum station number of slave station

b: Minimum station number of slave station

*: $\text{Min}(a, b) = A \text{ or } B$, whichever is smaller

If the maximum data length (Max_Diag_Data_Len) of the error information described in the GSD file of a slave station is greater than the value calculated by the above expression, normal communication may not be made with that slave station.

If normal communication cannot be made, try the following methods:

(a) Set the station numbers of the slave stations with no unused numbers in between.

(b) Make setting on the slave station side to shorten the maximum data length of the error information. (If possible)

(c) Using two or more AJ71PB92D/A1SJ71PB92D, reduce the number of slave stations per module.

(2) Restrictions on parameter data length of slave station

The parameter size which can be set in AJ71PB92D/A1SJ71PB92D should meet the following formula.

Note that the system construction which does not meet the following formula causes the error of 1302H.

$$5 + \sum_{i=1}^n (\text{number of parameter blocks of each slave station}) \leq 128$$

n = number of slave stations

Σ (number of parameter blocks of each slave station) = sum total of the numbers of parameter blocks calculated by each slave station

The number of parameter blocks for each station is decided by the parameter size of the station as follows.

Parameter size of each slave station	Number of blocks of each slave station
246 bytes or less	1 block
247 to 480 bytes	4 blocks
481 to 720 bytes	5 blocks
721 to 762 bytes	6 blocks

Calculate the parameter size of each slave station using the following formula.

$$\text{Parameter size of each slave station} = 31 + (\text{User_Param data length}) + (\text{configuration data length}) + \alpha$$

(a) User_Param data length

The value of User_Prm_Data usage on the screen displayed when Select Modules is selected on the slave station setting screen of GX Configurator-DP.

(b) Configuration data length

The value differs depending on the slave station type as shown below.

1) Module type slave station

Sum of the number of Module set values, which are described in the GSD file of the slave station, of the modules registered to the [slot] Installed Module list.

(Example) [slot] Installed Module registration status of GX Configurator-DP

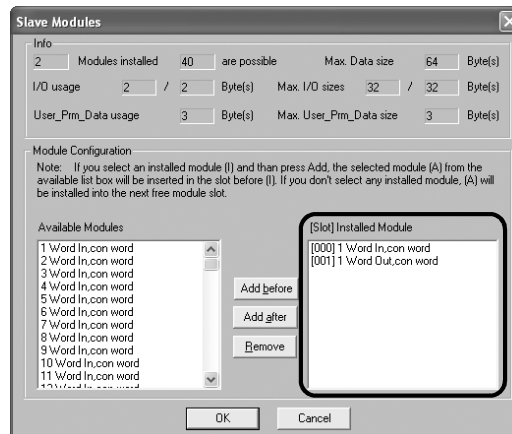

SD file description

Module="1 Word In,con word" 0x50

Module="1 Word Out,con word" 0x60

Number of set values is "1" } Configuration data length is "2".
 Number of set values is "1" }

2) Block type slave station

Number of Module set values described in the GSD file of the slave station.

(Example) GSD file description

Module="1 Byte Out,3 Byte In" 0x20,0x12

As the number of set values is "2", the configuration data length is "2".

(c) α (constant)

$\alpha = 2$: When the slave station has only input or output

$\alpha = 4$: When the slave station has both input and output

(example)

When the system is constructed using only the slave stations with 520 bytes parameter, AJ71PB92D/A1SJ71PB92D can be connected up to the following number of the slave stations.

When the parameter size is 520 bytes, the number of the parameter block is five.

$$5 + (5 \times n) \leq 128 \quad : n = \text{number of slaves}$$

$$n \leq \frac{128 - 5}{5} = 24.6$$

$$n = 24$$

The calculation mentioned above tells that AJ71PB92D/A1SJ71PB92D can be connected up to 24 slave stations.

Therefore, when 25 slave stations or more are set by the parameter, AJ71PB92D/A1SJ71PB92D detects the error of 1302H.

4. FUNCTIONS

4.1 Functions for Exchanging with Slaves

The main function in the AJ71PB92D/A1SJ71BP92D is for exchanging I/O data with slave stations connected to the PROFIBUS-DP network. The method used for this exchange is to read/write the I/O image in the buffer memory using FROM/TO instructions.

A schematic drawing of this exchange function is as follows.

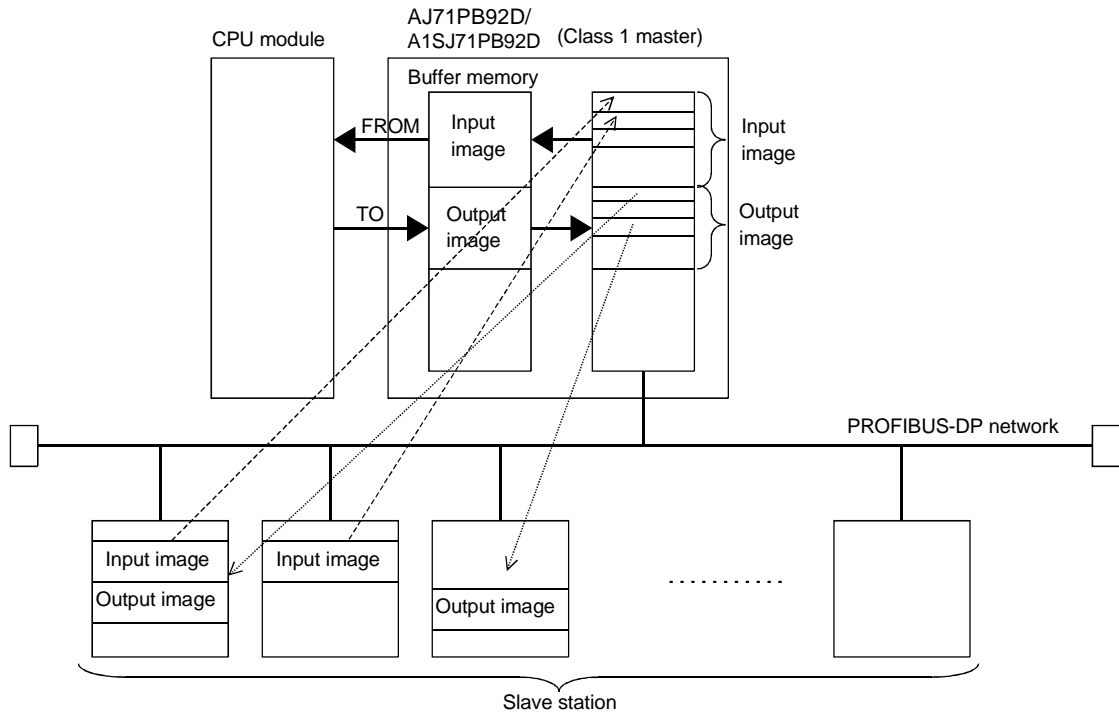

4.1.1 Exchange flow

The I/O data exchange flow with slave station is shown below.

* The buffer memory refresh with the FROM/TO instructions is conducted asynchronously.

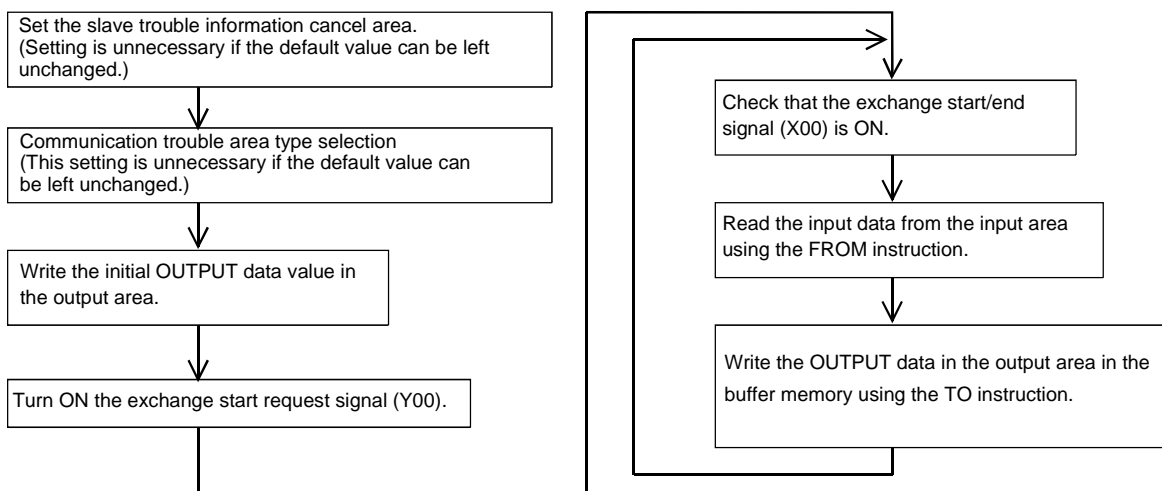

4.1.2 Global control functions

Global control contains the four functions of SYNC, UNSYNC, FREEZE, and UNFREEZE, which are functions that are used to maintain/cancel slave I/O for which multicast communication is conducted at the same time.

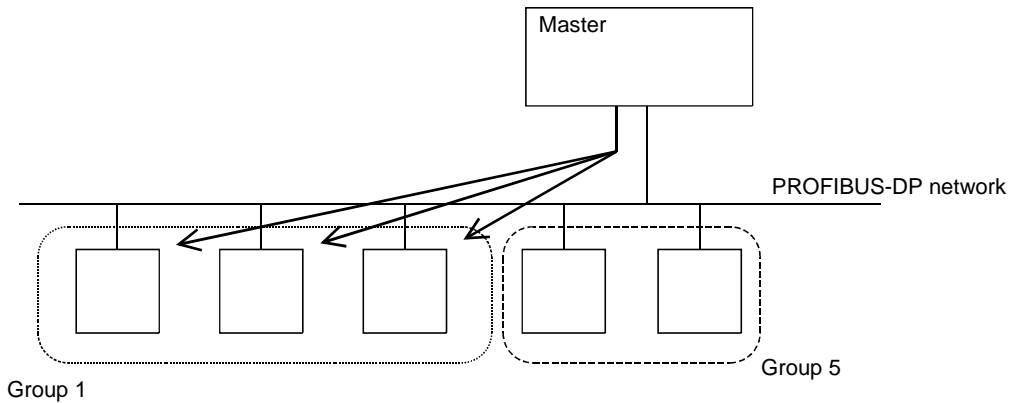

The slaves that execute the global control function are those located in one or more groups of the eight groups. The group No. of the group containing the slaves is set by the configurator. In the AJ71PB92D/A1SJ71PB92D the group can be arbitrary specified and the global control commands transmitted using multicast communication. This makes it possible to select a slave and conduct global control.

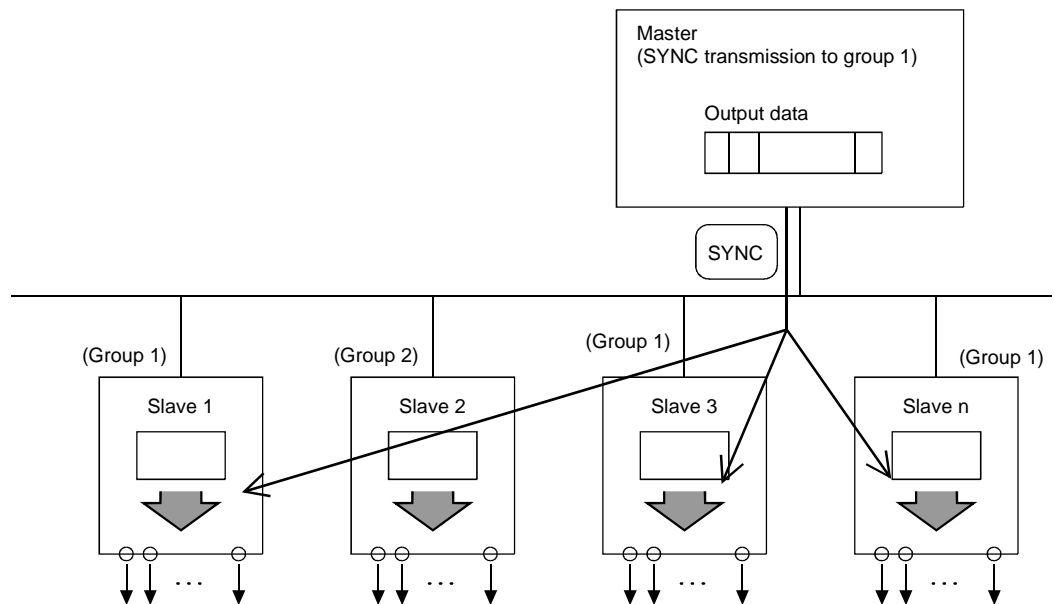

The global control function is executed using X, Y, and FROM/TO instructions from the sequence program.

(1) Service SYNC, UNSYNC

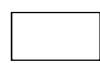

-  ... Output image memory: Data is always refreshed using polling.
-  ... <During UNSYNC execution/default>The output image memory value is output unchanged (normal condition)
 ... <During SYNC execution>The output image memory value is only output once during the SYNC service timing.
-  ... Service SYNC (issued in the same group)

(2) Service FREEZE, UNFREEZE

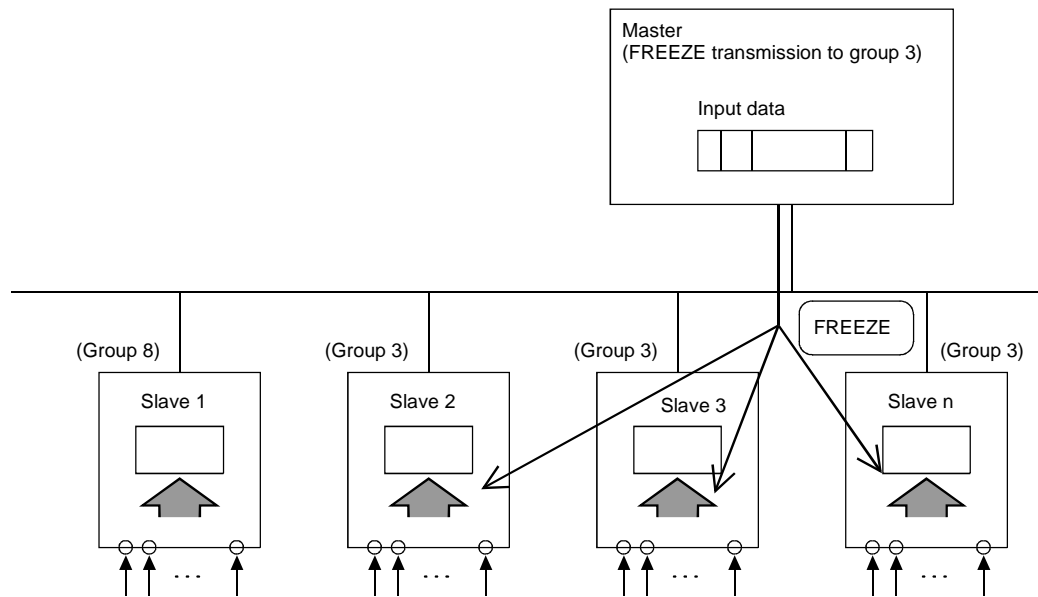

... Input image memory: The data is always refreshed by polling.



... <during FREEZE cancel/default>The actual input is input to the input memory unchanged (normal condition)

<during FREEZE execute>The actual input is input once into the input image memory at the FREEZE service timing.



... Service FREEZE (issued within the same group)

(3) Group selection

- The number of groups is from 1 to 8 if with a total of 8 groups.
- The slave can exist in arbitrary group of the 8 groups. They can also exist in multiple groups. (The configurator specifies in which group which slaves exist.)
- Multiple groups can be arbitrarily selected from the sequence program and global control executed.
- When selecting group 0 and transmitting the service is transmitted to all slave stations.

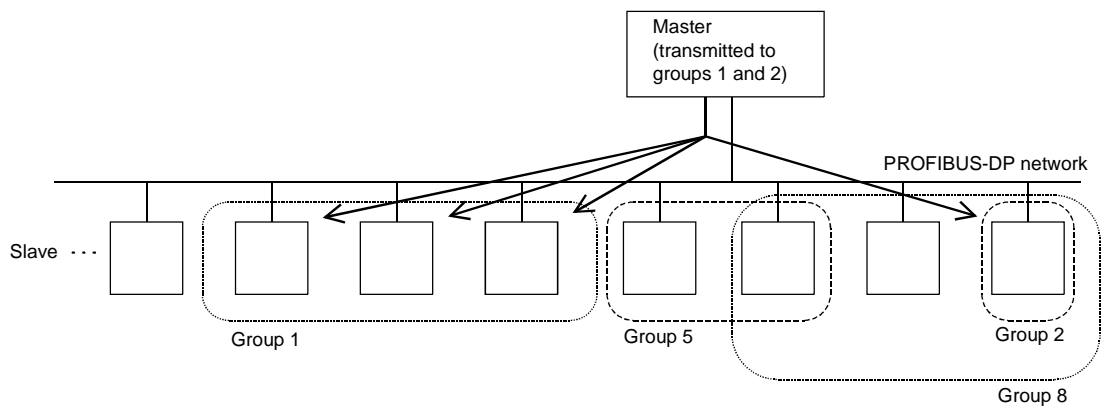

(4) Procedure for issuing a global service.

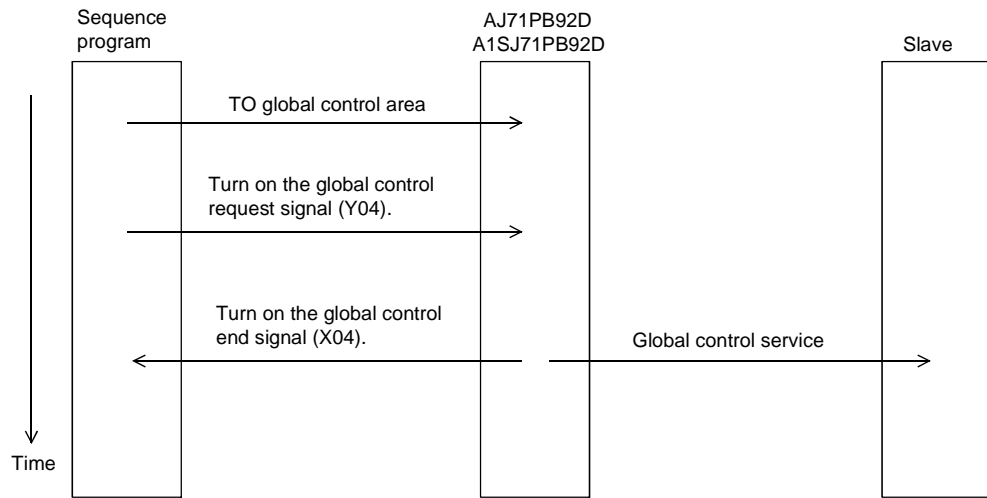

4.2 I/O Signal

4.2.1 I/O signal list

The I/O signal configuration used in the AJ71PB92D/A1SJ71PB92D and the data communications with the PLC CPU are described below.

Signal direction: AJ71PB92D/A1SJ71PB92D → PLC CPU		Signal direction: PLC CPU → AJ71PB92D/A1SJ71PB92D		
Device No.	Description	Device No.	Description	
X00	Exchange start end signal	Y00	Exchange start request signal	
X01	Communication trouble detection signal	Y01	Communication trouble detection signal reset	
X02	Communication trouble area clear end signal	Y02	Communication trouble area clear request signal	
X03	Not usable	Y03	Communication trouble area type selection	
X04	Global control end signal	Y04	Global control request signal	
X05	Global control error end	Y05	Not usable	
X06	Not usable	⋮		
⋮		⋮		
X0C		Y0C		
X0D	Watchdog timer error signal	Y0D	Startup request signal	
X0E	Not usable	Y0E	Not usable	
X0F		⋮		
X10	Operation mode signal	Y10		
X11	Operation mode change completion signal	Y11	Operation mode change request signal	
X12	Not usable	Y12	Not usable	
⋮		⋮		
X1A		⋮		
X1B		Communication READY signal		⋮
X1C		Not usable		⋮
X1D	Module READY signal	⋮		
X1E to X1F	Not usable	Y1F		

Point

If a device which is not usable is accidentally turned on and off in the sequence program, it cannot guarantee as the AJ71PB92D/A1SJ71PB92D function.

4.2.2 I/O signal detail description

(1) Exchange start request signal (Y00), exchange start end signal (X00)

- (a) After the exchange start request signal (Y00) is turned on by the sequence program the exchange start end signal (X00) is turned on when cyclic exchange starts.
- (b) The exchange start end signal (X00) turns off in either of the following cases.
 - When the exchange start request signal (Y00) is turned off
 - When the parameters are written from the configurator to the AJ71PB92D/A1SJ71PB92D

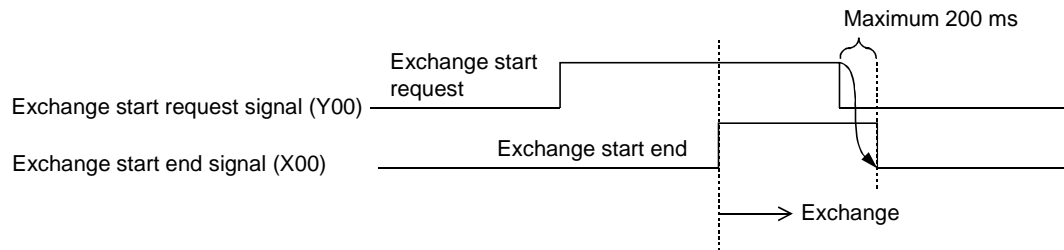

- (c) An interlock is used for FROM/TO of the I/O data.
- (d) Before the exchange start request signal is turned on the output data initial value must be written to the buffer memory.

(2) Communication trouble detection signal (X01), communication trouble detection signal reset (Y01)

- (a) The communication trouble detection signal (X01) is turned on when a communication trouble occurs. At the same time the RSP ERR.'s LED turns on. At this time the error code and detailed data are stored in the buffer memory communication trouble area.
- (b) The communication trouble detection signal (X01) is turned off when the communication trouble detection signal reset signal (Y01) is turned on from the sequence program or when communication failure is all resolved. At this time, the RSP ERR. LED is turned off.
- (c) The communication trouble detection signal reset (Y01) is turned off by the sequence program after it has been confirmed that the communication trouble detection signal (X01) has been turned off.
- (d) The following sequence is used.

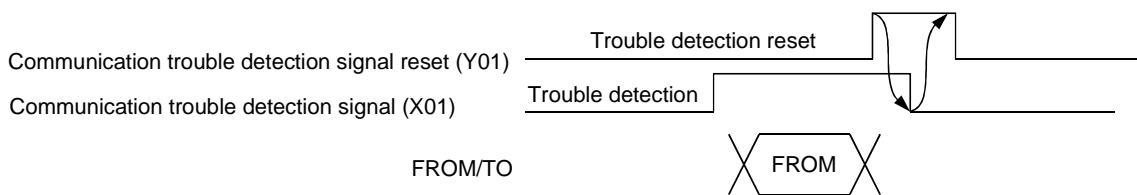

The error code is read from the buffer memory to the PLC CPU.

(3) Communication trouble area clear request (Y02), communication trouble area clear end (X02)

- (a) The communication trouble area clear request (Y02) is turned on by the sequence program when all of the communication trouble areas and extension trouble areas are cleared.
- (b) The communication trouble clear end signal (X02) is turned on after all of the communication trouble area and extension trouble areas are cleared by turning on the communication trouble area clear request signal (Y02).
- (c) The communication trouble area clear request (Y02) is turned off by the sequence program after it has been confirmed that the communication trouble area clear end signal (X02) has been turned on.
- (e) When the communication trouble area clear request signal (Y02) is turned off the communication trouble area clear end signal is turned off.
- (d) A sequence like the one below is used.

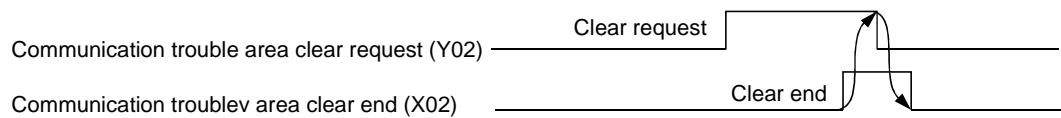

(4) Global control request signal (Y04), global control end signal (X04)

- (a) The global control end signal (X04) is turned on after service processing has ended when the global control request signal (Y04) is turned on by the sequence program.
- (b) The global control request signal (Y04) is turned off by the sequence program after it has been confirmed that the global control service end signal (X04) has turned on.
- (c) When the global control request signal (Y04) is turned off the global control end signal (X04) turns off.
- (d) The global control request signal (Y04) cannot be received if the exchange starting (X00) is not on. If Y04 is turned on when X00 is off then both X04 and X05 will turn on.
- (e) A sequence like the one below is used.

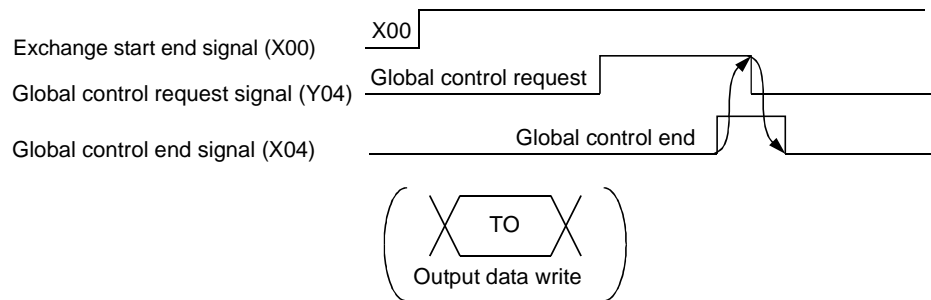

(5) Global control error end signal (X05)

- (a) If global control is requested when exchange start (X00) is not on then global control error end (X05) and the global control service end signal (X04) will turn on at the same time.
- (b) The slave I/O is not held/deleted when the global control error end signal (X05) is on.

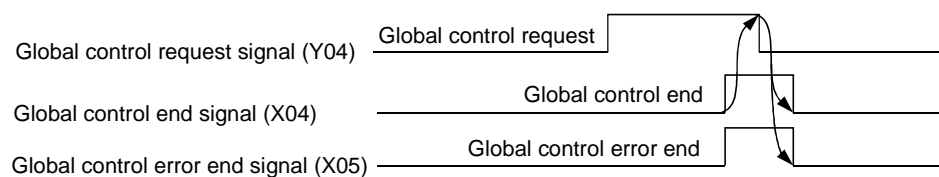

(6) Watchdog timer error end (X0D)

- (a) This turns on when a Watchdog timer error occurs.
- (b) This will not turn off until the module is reset or its power supply is turned off and on.

(7) Operation mode signal (X10)

Indicates whether the current operation mode is the parameter setting mode or not.

ON: Parameter setting mode

OFF: Normal service mode/extended service mode

(8) Operation mode change request signal (Y11), operation mode change completion signal (X11)

Used to change the operation mode without resetting the CPU module.

This function is valid only when a start is made with the mode setting switch in the 0, 1 or E position.

- (a) Operation mode change request signal (Y11)
 - OFF "ON: Requests the operation mode to be switched to the one specified in the operation mode change request area (address 2255/8CFh) of the buffer memory.
 - ON "OFF: Turns off X11.
- (b) Operation mode change completion signal (X11)
 - Turns on when the result is stored into the operation mode change result area (address 2256/8D0h) of the buffer memory. This signal also turns on on normal or abnormal completion of an operation mode change.
 - This signal turns off when Y11 turns from ON to OFF.

(9) Communication READY signal (X1B)

- (a) This is turned on when the station enters the exchange start possible state after the AJ71PB92D/A1SJ71PB92D has started up and the module READY signal (X1D) has turned on. (Only during the normal transmission mode.)
- (b) This turns off when a exchange continuation impossible error occurs.
- (c) The exchange start request signal (Y00) is used as an interlock when turned on by the sequence program.

(10) Module READY signal (X1D)

- (a) This is turned on when the AJ71PB92D/A1SJ71PB92D is started up. Therefore, it is turned on regardless of the operation mode.
- (b) This is turned of when the AJ71PB92D/A1SJ71PB92D goes down.

(11) Communication trouble area type selection (Y03)

- (a) This is used to select the communication trouble area type (ring type or fixed type).
- (b) This is turned off when ring type is selected and on when fixed type is selected.
- (c) This signal becomes valid when the exchange start or communication trouble area clear request (Y02) is on.

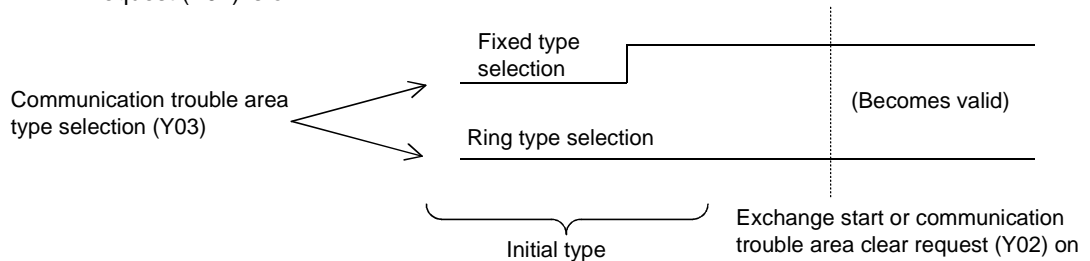

(12) Restart request signal (Y0D)

- (a) When the AJ71PB92D/A1SJ71PB92D goes down for some reason (when the FAULT LED turns on and X1D is off) then turning Y0D from off to on to off again will make it possible to restart the AJ71PB92D/A1SJ71PB92D.
- (b) The same state will be entered if after start up the power supply is turned off and then on again.

4.3 Buffer Memory List

4.3.1 Buffer memory/configuration

The configuration of the buffer memory used to receive and send data with the AJ71PB92D/A1SJ71PB92D and the PLC CPU is described below.

Buffer memory address
(decimal/hexadecimal)

0/	0h	Input area (Description) This is the area that stores the input data from the slave.
959/	3BFh	
960/	3C0h	Output area (Description) This is the area that stores the output data to the slave.
1919/	77Fh	
1920/	780h	Address information area (Description) This is the area that shows the slave address and I/O data length.
2039/	7F7h	
2040/	7F8h	Communication trouble area (Description) This is the area that shows the trouble information that occurred during communication.
2079/	81Fh	
2080/	820h	Slave error information cancel area (Description) This is the area that sets the data that masks the slave trouble information.
2081/	821h	Global control area (Description) This is the global control function hold/cancel selection area.
2082/	822h	Not usable
2083/	823h	Time out time setting area (Closed to users because this is a debugging function.) (Description) This is used to set the time out time when an exchange start/stop is executed.
2084/	824h	Trouble no information time setting area (Description) This is used to set the time that does not inform the communication trouble after the exchange start.
2085/	825h	
2095/	82Fh	Not usable
2096/	830h	Expansion communication trouble area (Description) This area shows the expansion information of the trouble information which is occurred during the communication.
2110/	83Eh	
2111/	83Fh	Not usable
2112/	840h	Slave status area (Description) This is the area that shows the status information of each slave.
2116/	844h	
2117/	845h	
2127/	84Fh	Not usable
2128/	850h	Input/Output start address area (Extended service mode only) (Description) This is the area that shows the addresses to start the input area and output area of each slave.
2247/	8C7h	
2248/	8C8h	
2253/	8CDh	Not usable
2254/	8CEh	Current operation mode (Description) This area indicates the operation mode of the AJ71PB92D/A1SJ71PB92D when it has started up.
2255/	8CFh	Operation mode change request area (Description) In this area, set the operation mode of the AJ71PB92D/A1SJ71PB92D which you want to choose.
2256/	8D0h	Operation mode change result area (Description) This area indicates the execution result of the operation mode change request.
2257/	8D1h	
3775/	EBFh	Not usable

Point

Don't read and write to the buffer memory which is not usable.
If you perform it, it cannot guarantee as the AJ71PB92D/A1SJ71PB92D function.

4.3.2 Buffer memory detailed description

(1) INPUT area

Either normal service mode or extended service mode can be selected via the mode switch on the main unit.

(a) Normal service mode (MODE switch : No. 0)

This is the area that stores the input data from the slave station.

This area is fixed to an allocation of 32 bytes (16 words) per station for a total of 60 stations worth. This input area configuration is as follows.

Example : When the input data length for the first station is set to 29 bytes and that for the second station to 32 bytes

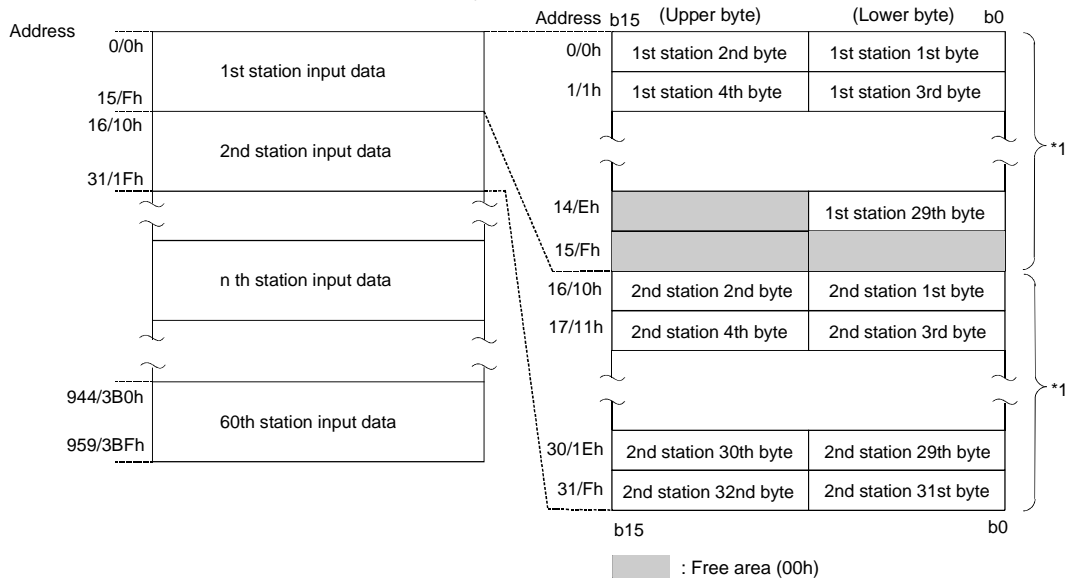

*1: Since the data area is fixed to 32 bytes, all unused areas will become free.

Point	<p>The input data of the slave station, which was disabled from communication during normal communication and whose corresponding bit of the communication status area*1 turned ON (1), is not stored into the input area of the AJ71PB92D/A1SJ71PB92D.</p> <p>In the input area of the corresponding slave station, the data before communication failure is held.</p> <p>*1: Indicates the area of buffer memory addresses 2113 (841H) to 2116 (844H) in the slave status area.</p>
--------------	---

- (b) Extended service mode (MODE switch : No. E)
 This is the area that stores the input data from the slave station.
 In this area, the data length (in byte units) for each station is assigned in variable length according to the parameter file set in the configurator software package.
 The data length can be set in the range of 0 to 244 bytes.
 Number of stations that can be set will vary in the range of 1 to 60, depending on the specified data length. For example, seven stations can be set if the data length for each station is 244 bytes, and 60 stations if the data length is 32 bytes.
 Example : When the input data length for the first station is set to 23 bytes and that for the second station to 7 bytes

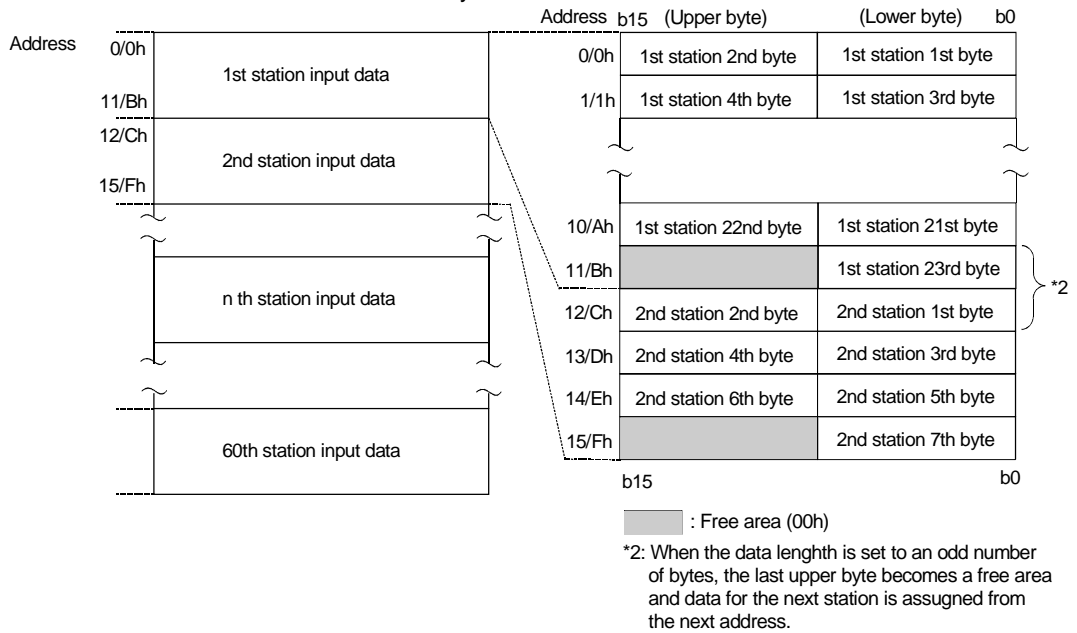

Point	<p>The input data of the slave station, which was disabled from communication during normal communication and whose corresponding bit of the communication status area*1 turned ON (1), is not stored into the input area of the AJ71PB92D/A1SJ71PB92D.</p> <p>In the input area of the corresponding slave station, the data before communication failure is held.</p> <p>*1: Indicates the area of buffer memory addresses 2113 (841H) to 2116 (844H) in the slave status area.</p>
--------------	---

(2) OUTPUT area

Either normal service mode or extended service mode can be selected via the mode switch on the main unit.

(a) Normal service mode (MODE Switch : No. 0)

This is the area that stores the output data to the slave station.

This area is fixed to an allocation of 32 bytes (16 words) per station for a total of 60 stations worth. This output area configuration is as follows.

Example : When the output data length for the first station is set to 1 bytes and that for the second station to 3 bytes

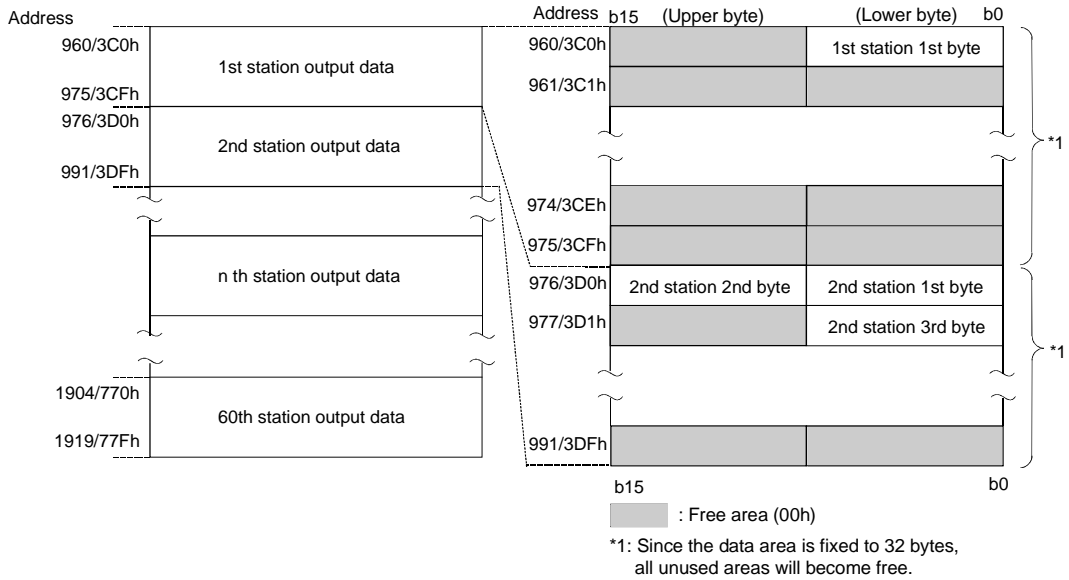

(b) Extended service mode (MODE switch : No. E)

This is the area that stores the output data to the slave station.

In this area, the data length (in byte units) for each station is assigned in variable length according to the parameter file set in the configurator software package.

The data length can be set in the range of 0 to 244 bytes.

Number of stations that can be set will vary in the range of 1 to 60, depending on the specified data length. For example, seven stations can be set if the data length for each station is 244 bytes, and 60 stations if the data length is 32 bytes.

Example : When the output data length for the first station is set to 19 bytes and that for the second station to 5 bytes

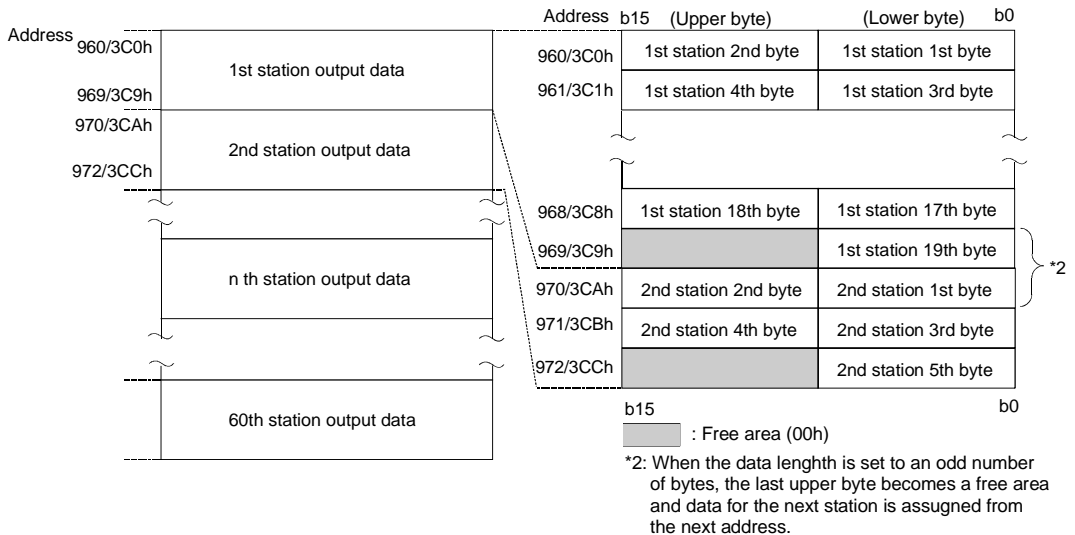

(3) Address information area

This area shows the station address, input byte length, and output byte length for each slave station. This allocation is set by the configurator. The station addresses for the 1st through the 60th stations are stored in the order of registration in the configurator. (Station addresses: 1 to 126, do not need to be sequential numbers.)

The address information area configuration is shown below. For details refer to Section 4.3.2 (4).

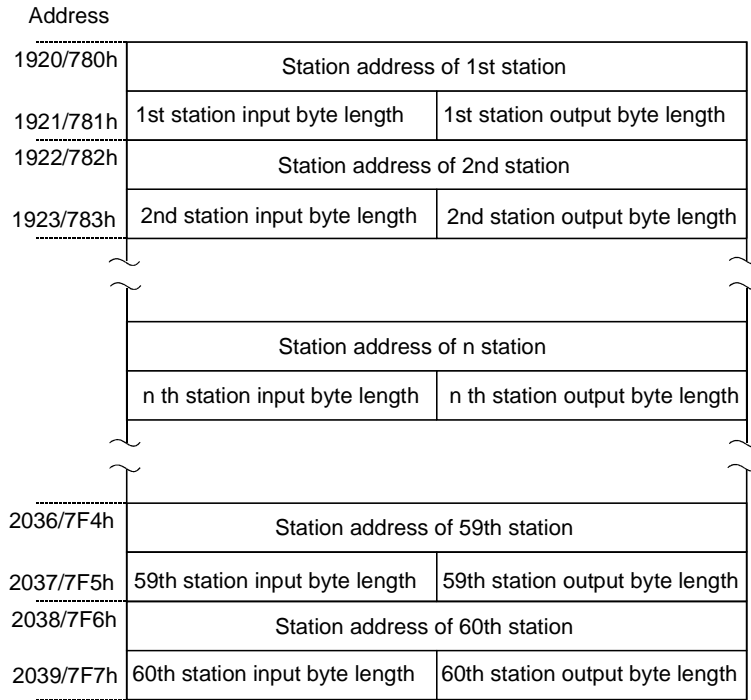

- (a) The station address of unallocated stations is FFFFh, and the I/O byte is FFh.
- (b) When the I/O byte length of allocated stations is 0, a 0 is stored for the byte length.
- (c) The n does not show the station address but represents a number (the nth number) used for the input/output area.

(4) Example address information area, INPUT area, and OUTPUT area

The AJ71PB92D/A1SJ71PB92D reads the slave station address and I/O byte length set by the parameter file which is set by the configurator and stores these in the buffer memory address information area.

With the AJ71PB92D/A1SJ71PB92D, I/O areas are assigned to each slave station based on the I/O byte length information in the address information area, and each I/O data will be stored in the corresponding buffer memory area.

Example : At extended service mode
INPUT/OUTPUT area

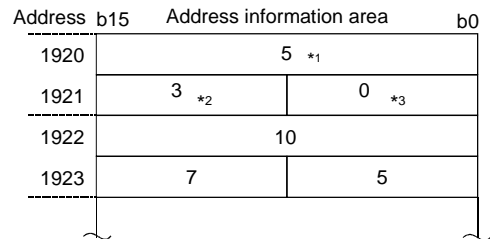
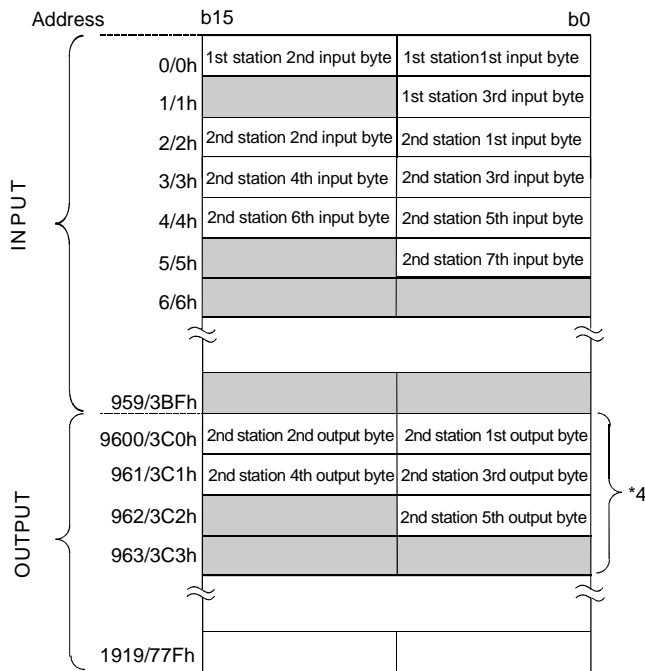

*1: Station address (FFFFh if not assigned)
 *2: Input byte length (FFh if not assigned)
 *3: Output byte length (FFh if not assigned)
 *1, *2 and *3 are also set in a reserved station.

■ : Vacant area
 (The free areas in the INPUT area are initialized with [00h].)

*4: Since output from the first station has a byte length of 0, no area is allocated in the OUTPUT area.

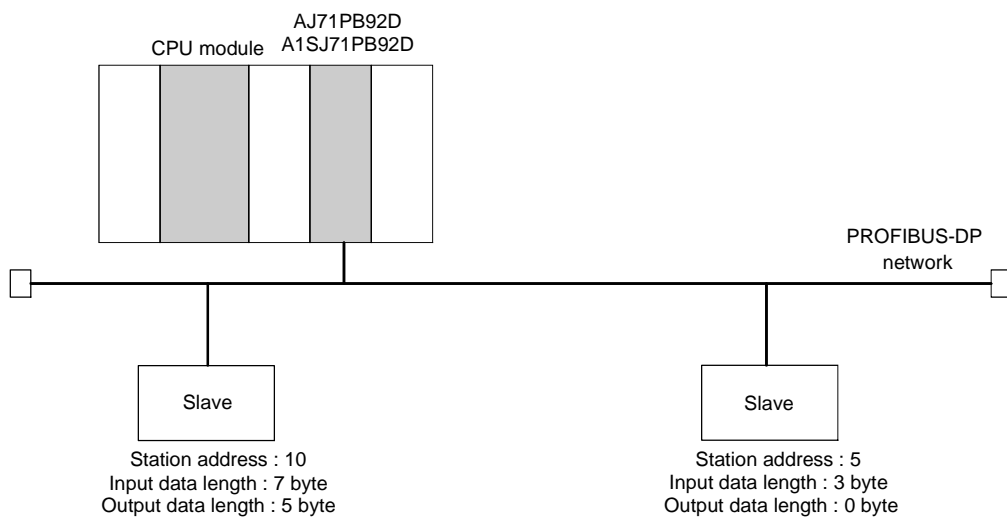

(5) Communication trouble area

When some kind of trouble occurs during communication the AJ71PB92D/A1SJ71PB92D stores the contents of the trouble in this area. Fixed type or ring type can be selected for this area by turning the communication trouble area type selection (Y03) on or off (refer to Section 4.2.2 (9)).

As shown in the following diagram, a total of 8 pieces of trouble information that consist of the trouble code, detailed data length, and detailed data can be stored in the basic configuration regardless of whether for fixed or ring data.

Ring type data is stored in order from the header with the header always being the latest trouble information.

With fixed type data, when 8 pieces of trouble information are stored the areas 2 to 8 (data 1 to 7) are fixed, so when the next new trouble occurs only header area 1 (data 8) is updated.

All trouble information for either type can be cleared by turning on the communication trouble area clear request signal (Y02). When the communication trouble detection signal reset signal (Y01) is on, the contents of the communication trouble area are held though the communication trouble detection signal (X01) turns off.

The communication trouble area is configured as shown below.

(a) Communication trouble area configuration

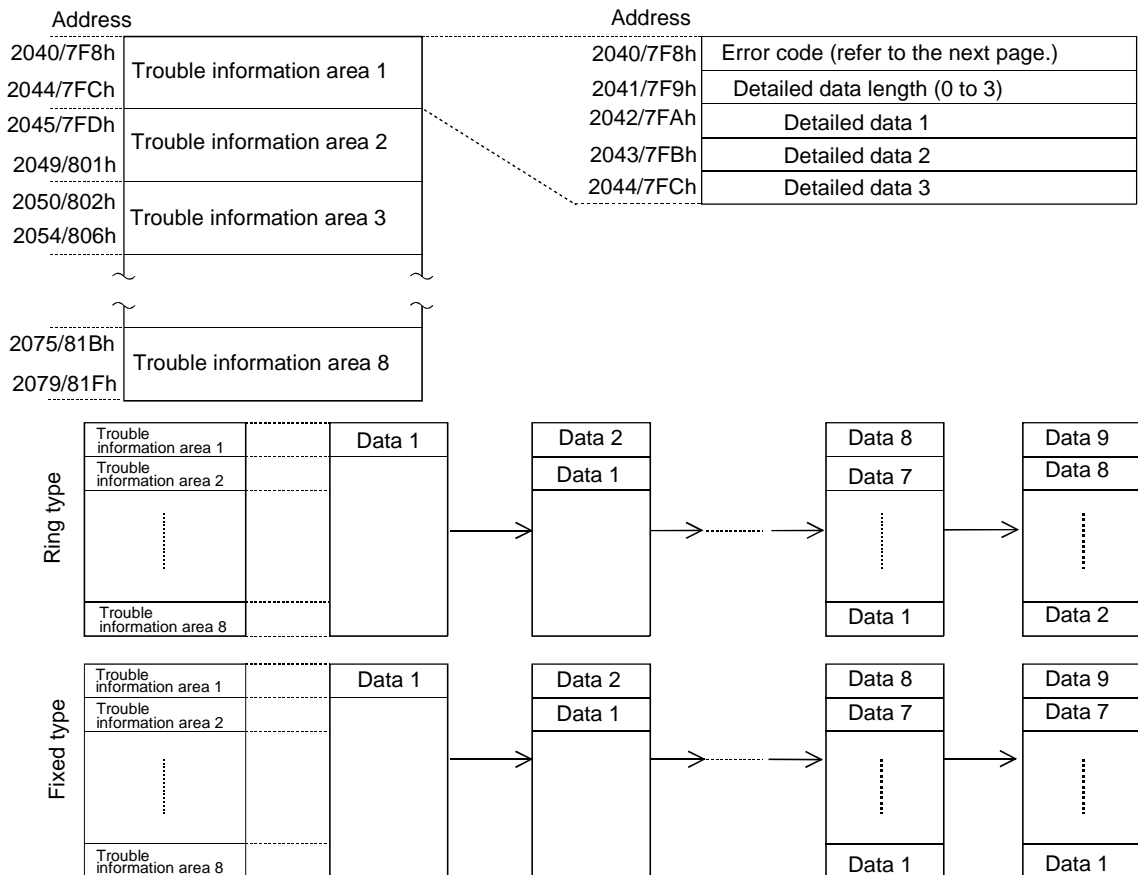

(b) Error codes

The error codes are shown below.

Error Code	Data length	Detailed data			Description	Communication state	User processing
		1	2	3			
0200h	(c) Ref.	(c) Ref.	(c) Ref.	(c) Ref.	(c) Ref.	△	(c) Ref.
1121h	1	03h	—	—	The slave address specified in the parameter is the same as that of the master. This error occurs immediately after the power supply is turned on or the CPU is reset. Even though this error is occurring, if the exchange start (Y00) is on then error of error code 3000h will occur, the FAULT LED will turn on, and operation will stop.	×	
1300h	2	Contents ref.	Contents ref.	—	Not even 1 active slave station is set in the parameter. When this error occurs the detailed data is set to: Detailed data 1: Number of slaves set in the parameter. Detailed data 2: Number of active slaves set in the parameter. This error occurs immediately after the power supply is turned on or the CPU is reset. Even though this error is occurring, if the exchange start (Y00) is on then error of error code 3000h will occur, the FAULT LED will turn on, and operation will stop.	×	1) Set 1 or more active slaves in the parameter. 2) When the FAULT LED is turned on, reset is enabled by turning OFF→ON→OFF the Y0D
3000h	1	Ignored	—	—	1) When the above errors 1300h or 1121h have occurred before this error: Refer to errors 1300h, 1121h above. 2) Otherwise An unexpected error has occurred.	×	For 1) Refer to the above 1300h, 1121h errors. For 2) Contact the nearest Mitsubishi Electric branch office or dealer.

×: Exchange stops after the error occurs. △: Exchange continues.

- (c) When the trouble code = 0200h
 For a slave trouble information occurrence (error code = 0200h), the slave trouble information is stored in the detailed data. The communication trouble area configuration for this case is shown below. In addition, the expansion communication trouble information is stored in buffer memory 2096 to 2110 for only the latest trouble information of the error code = 0200h trouble information. For information regarding the expansion communication trouble information refer to Section 4.3.2 (6).

	Error code = slave trouble information occurrence	
	Detailed data length = 3	
Detailed data 1	Master address (*1)	Slave address (*2)
Detailed data 2	Trouble information	
Detailed data 3	Slave ID (*3)	

- *1 The station address of the master station that controls the slave station in which this trouble information occurred is stored. However, FFh is stored when the trouble information shows the exchange with the slave is failed.
- *2 The station address of the slave station in which this trouble information occurred is stored.
- *3 Individual slave inherent ID No. from the PNO is stored. However, FFh is stored for trouble information that shows that the exchange with the slave failed.

The trouble information is shown in a 16-bit bit string, and the bits that correspond to the respective trouble occurrences are set. A description of the error information is given below.

bit	Description	Communication state	Processing	Setting station
15	Controlled by another master.	△	Multiple masters are trying to communicate with the same slave, so recheck the parameter.	Master
14	The parameter transmitted by the master is incorrect.	△	Check the parameter.	Slave
13	The response from the slave is incorrect.	△	Check the slave or network status.	Master
12	The function requested by the master is not supported.	△	Check the slave specifications. Especially if global control is supported.	Slave
11	Expansion trouble information exists.	△	Check the slave status. (refer to User's Manual.)	Master
10	The I/O byte size parameter received from the master does not match that of the slave.	△	Check the slave parameter.	Slave
9	The slave is not ready to exchange.	△	This trouble information will always occur at exchange start, so it can be ignored. If this trouble occurs during exchange, check the slave status and communication circuit.	Slave
8	Exchange with the slave cannot be conducted.	△	Check the slave status and communication circuit. And check the parameter.	Master
7	Separated from the cyclic exchange by the parameter setting.	△	This trouble information will always occur at exchange start, so it can be ignored. Check if the parameter on the network was changed by a class 2 master.	Master
6	0 (reserved)	—	—	Slave
5	The slave has entered the SYNC mode.	△	(Normal operation)	Slave
4	The slave has entered the FREEZE mode.	△	(Normal operation)	Slave
3	Watchdog monitoring is being conducted in the slave.	△	(Normal operation)	Slave
2	0 (fixed)	—	—	Slave
1	Diagnostic data read request.	△	Check the slave status.	Slave
0	Parameter allocation request from a slave.	△	This error information will always occur at exchange start, so it can be ignored. If this error occurs during exchange, check the slave status and communication circuit.	Slave

△ : Exchange continues even if trouble occurs.

(6) Expansion communication trouble area

This area shows the latest expansion trouble information for only one of the latest expansion trouble information in the error code 0200h error information stored in buffer memory K2040 to K2079 communication error area (Refer to Section 4.3.2 (5)).

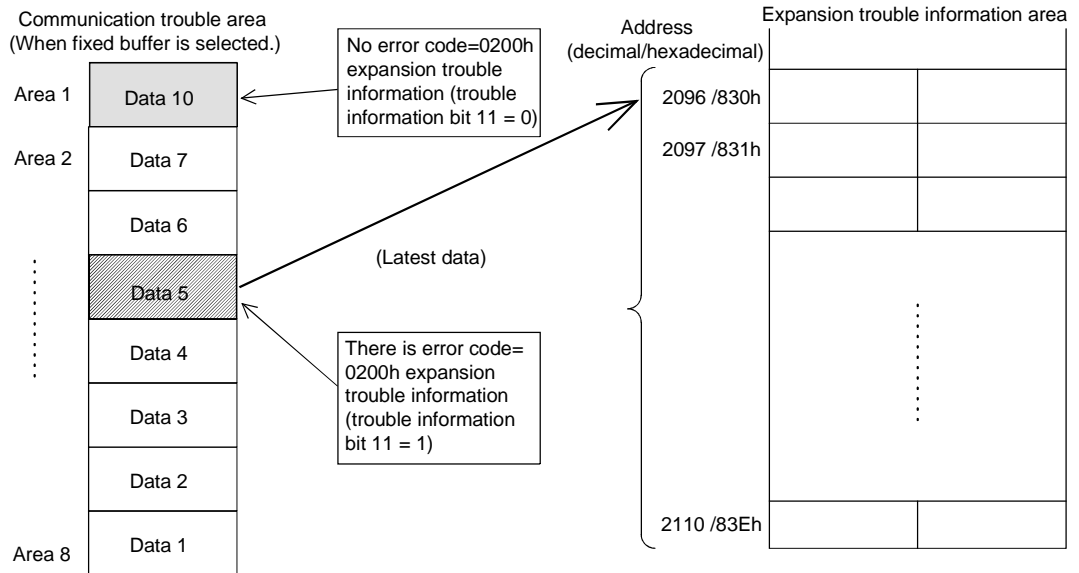

(a) Buffer Memory K2096

The latest expansion communication trouble information length stored from buffer memory K2098 is stored as a byte length unit.

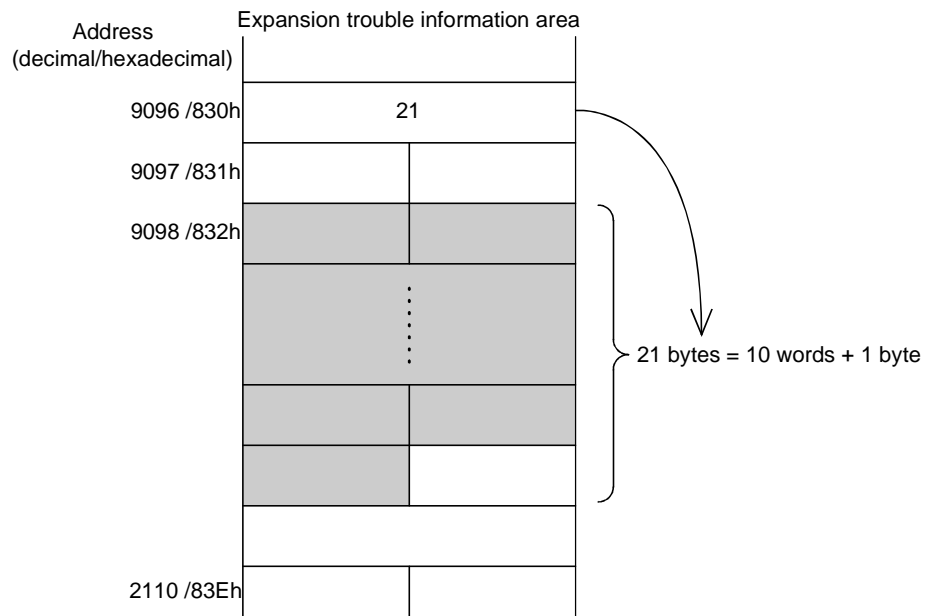

(b) Buffer memory K2097

Only bit 7 is valid. Other bit is fixed in 0. Bit 7 is turned on when the slave sends expansion trouble information that is 27 bytes or more.

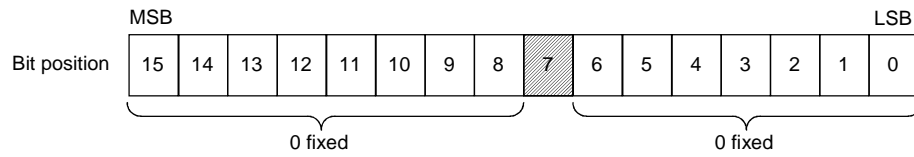

(c) Buffer memory K2098 to K2110

The following informations are stored in this area:

- Device related trouble information
- This area stores the slave station inherent self-diagnostic information that is not set by the PROFIBUS-DP standards.
- Identifier related trouble information
- For module type slave stations, whether or not a module error has occurred is stored as bit information.
- Channel related trouble information
- For module type slave station, this stores the, error information of all modules outputting an error.

1) Device Related trouble information

This stores the slave module inherent trouble information that is not set by the PROFIBUS-DP standards. The device related trouble can be divided by header and trouble information. This area stores a 2 bit value that is the device related trouble information in the header, including the header (1 byte), and the device related trouble information for this area.

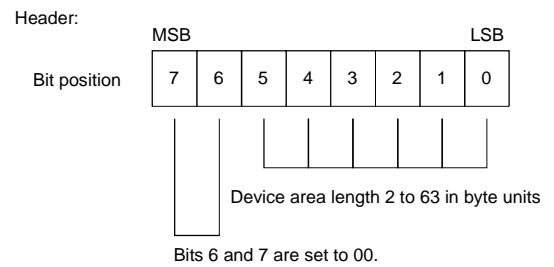
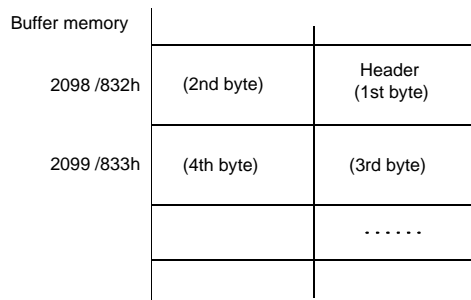

2) Identifier related trouble information

For module type slave stations, this stores as bit information whether or not a module is outputting an error. The identifier related trouble information can be divided into header and trouble information. This area stores a 2 bit value that is the identifier related trouble information in the header, including the header (1 byte), and the device related trouble information for this area.

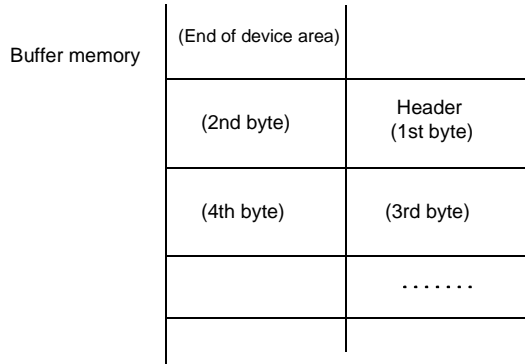

Header:

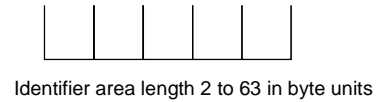
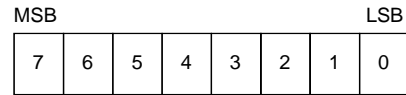

Bits 6 and 7 are set as 01.

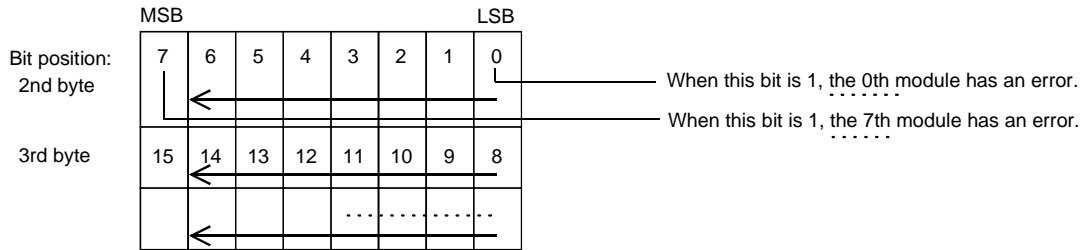

3) Channel related trouble information

When a module type slave station, this area stores the trouble information for each module that is outputting an error. This area does not have a header and stores this information at the end of the identifier related trouble information. Each channel trouble information consists of an identifier No., channel No., and error type of 3 bytes.

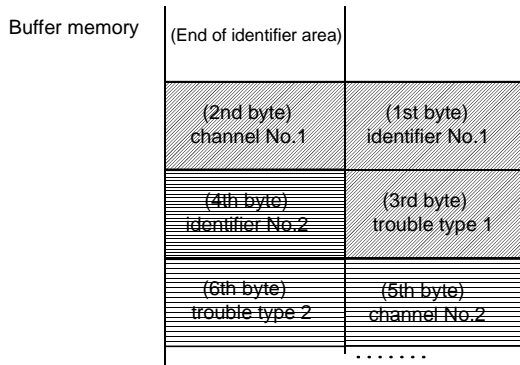

1st byte: Identifier No.

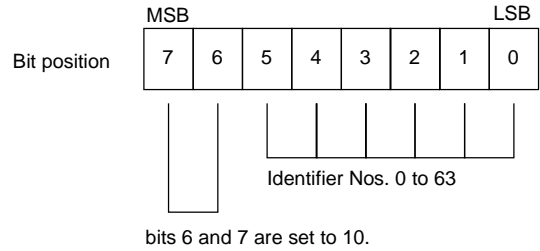

2nd byte: Channel No.

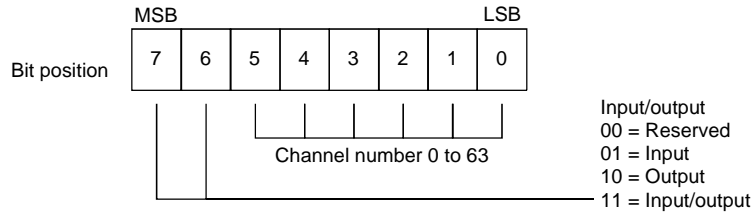

3rd byte: Trouble type

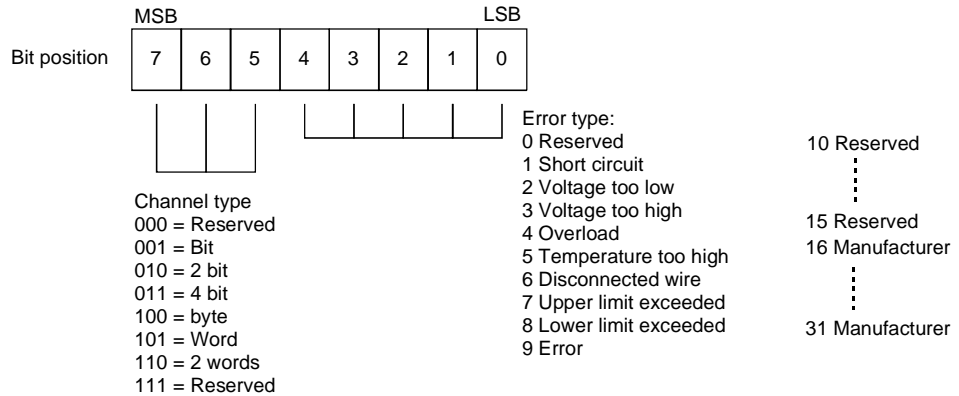

4) Identifier No., channel No.

The slave identifier No. and channel No. are discussed below. The identifier No. is the No. that is attached from the header of each slave module. Each module can have multiple channels. Refer to the each slave specifications regarding to the channel numbering method.

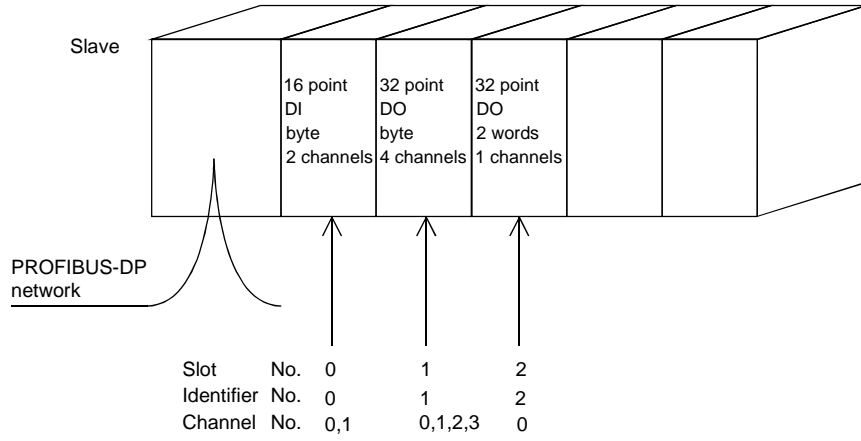

(7) Example expansion communication trouble area

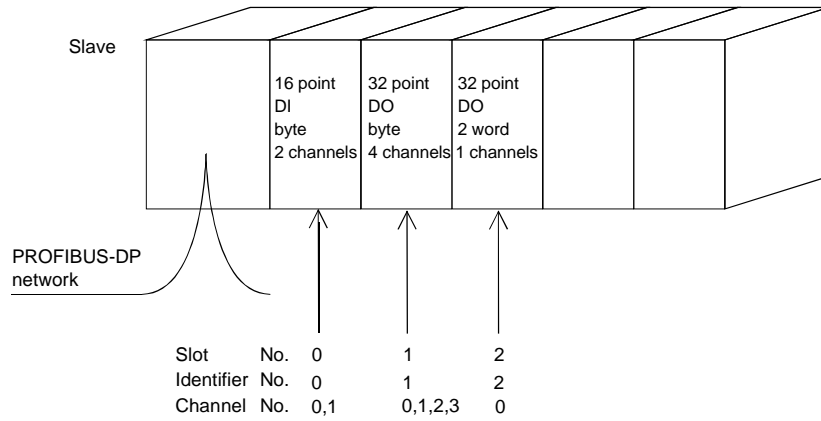
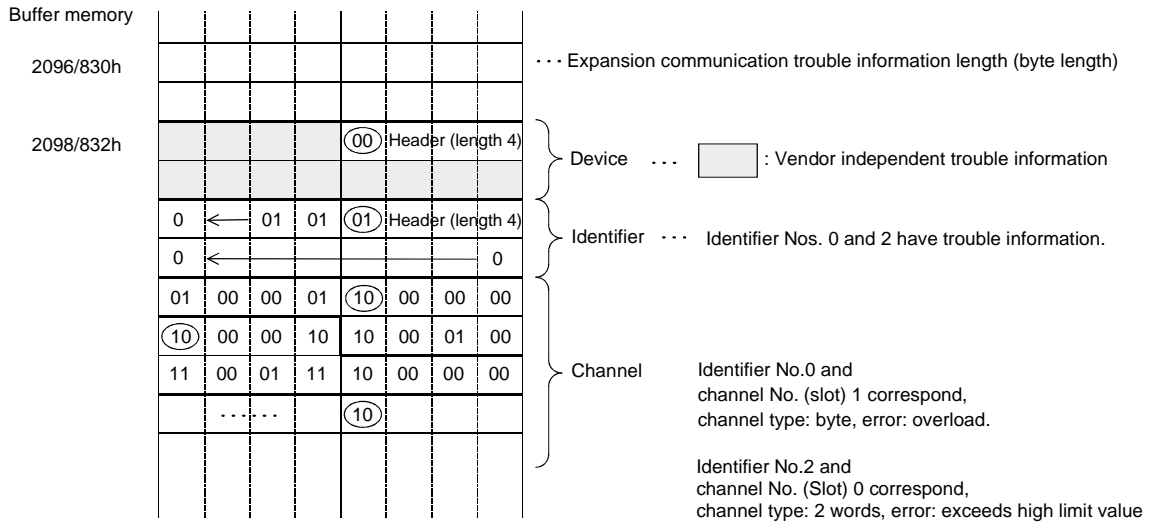

(8) Slave trouble information cancel area

This stores the value that masks the slave trouble information (error code = 0200h detailed data 2). Even if the slave trouble information corresponding to this area bit occurs the slave trouble information detection signal (X01) and RSP ERR. LED do not turn on. In addition, the trouble information is not stored in the trouble information area. The default value is 02B9h.

This 02B9h trouble information also occurs during normal situations and is masked. This value can only be changed when exchange start is off. (When on, changes are ignored.)

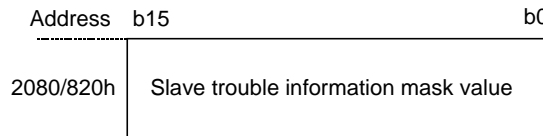

Slave trouble information

bit	Description
15	Controlled by another master.
14	The parameter sent by the master is incorrect.
13	The response from the slave is incorrect.
12	The function requested by the master is not supported.
11	Expansion trouble information exists.
10	The environment data received from the master does not match that of the slave.
9	The slave is not ready to exchange.
8	Cannot exchange with slave.
7	Separated from the cyclic exchange by the parameter.
6	0 (reserved)
5	The slave has entered the SYNC mode.
4	The slave has entered the FREEZE mode.
3	Watchdog timer monitoring is being conducted in the slave.
2	0 (fixed)
1	Diagnostic data read request
0	Parameter allocation request from the slave

To mask this trouble information

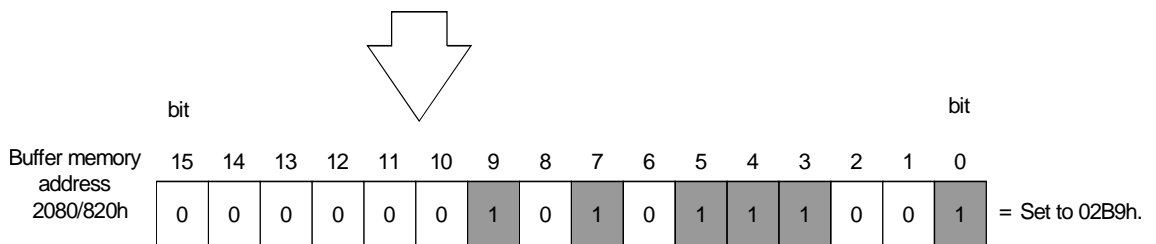

(9) Global control area

The buffer memory (2081/821h) value and corresponding command table are shown below.

Bit position	Value (valid/invalid)	Command	Description
8 to 15	1/0	Group 1 to 8 selection	Bits 8 to 15 correspond respectively to groups 1 to 8 and shows that the bit value is transmitted by the global control command to the 1 group (refer below). More than one group at a time can be selected from groups 1 to 8. When all bits 8 to 15 are 0, global control commands are sent to all the slaves.
5	1/0	SYNC	The actual output data is written and held.
4	1/0	UNSYNC	The actual output data hold is canceled.
3	1/0	FREEZE	The actual input data is held and read.
2	1/0	UNFREEZE	The actual input data hold is canceled.

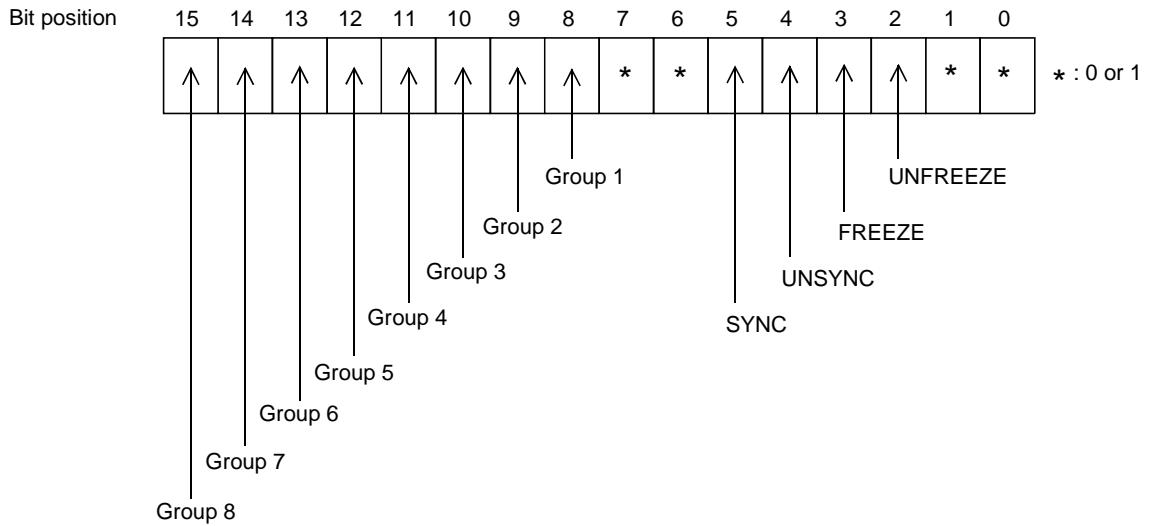

* Bit specifications for UNSYNC/SYNC and UNFREEZE/FREEZE

Bit position				Command			
5	4	3	2	SYNC	UNSYNC	FREEZE	UNFREEZE
0	0	0	0	×	×	×	×
0	0	*	1	×	×	×	○
0	0	1	0	×	×	○	×
*	1	0	0	×	○	×	×
1	0	0	0	○	×	×	×
*	1	*	1	×	○	×	○
*	1	1	0	×	○	○	×
1	0	*	1	○	×	×	○
1	0	1	0	○	×	○	×

* : 0 or 1
 ○ : Conducted
 × : Not conducted

(10) Trouble no information time setting area

Set the time at seconds unit, which does not inform the communication trouble after the exchange start. Default value is 20 seconds so the communication trouble is not informed for 20 seconds after the exchange start. By this setting, in case the master power supply ON is faster than the slave power supply ON etc., it makes possible to prohibit an error that occurs temporary when system starts up.

(11) Slave status area

This is the area that stores the status of each slave station.

The following figure shows the configuration:

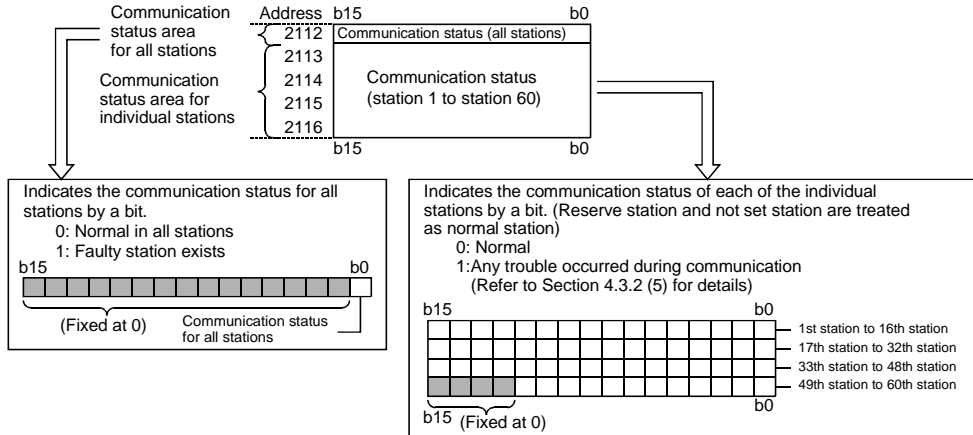

(12) I/O start address area (Extended service mode only)

This area stores the start addresses of I/O areas for each slave station.

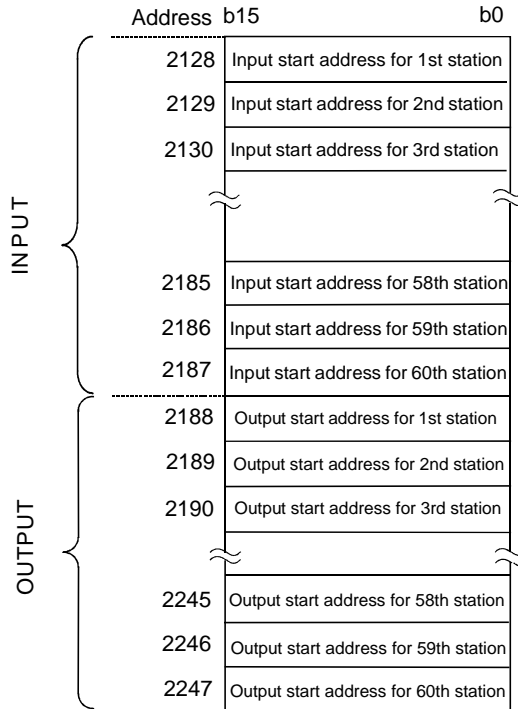

- This area is used while in the extended service mode (MODE switch: No. E) only. When in the normal service mode (MODE switch: No. 0), 0 is stored in all areas.
- Data is set in this area during module startup according to the parameters stored in the master station.
- The start address is set in 1 word units for both input and output. The data range is from 0 to 1919 (0 to 77Fh).
- The start addresses are stored in the INPUT area, starting from the head.
- When nothing is assigned, -1 (FFFFh) will be set.

Example: When the input byte length and output byte length for the first station are 3 bytes and 5 bytes, and those for the second station are 7 bytes and 3 bytes, respectively:

Address 2128 : 0 (0h) } Input start address
 Address 2129 : 2 (2h) }
 Address 2188 : 960 (3C0h) } Output start address
 Address 2189 : 963 (3C3h) }

• Input area
Address

0	1st station 2nd input byte	1st station 1st input byte
1		1st station 3rd input byte
2	2nd station 2nd input byte	2nd station 1st input byte
3	2nd station 4th input byte	2nd station 3rd input byte
4	2nd station 6th input byte	2nd station 5th input byte
5		2nd station 7th input byte

• Output area
Address

960	1st station 2nd output byte	1st station 1st output byte
961	1st station 4th output byte	1st station 3rd output byte
962		1st station 5th output byte
963	2nd station 2nd output byte	2nd station 1st output byte
964		2nd station 3rd output byte

(13) Current operation mode

This area stores the value which indicates the operation mode of the AJ71PB92D/A1SJ71PB92D when it has started up.

Value	Description
0000h	The module started up in the normal service mode which was temporarily selected from the CPU module.
0001h	The module started up in the parameter setting mode which was temporarily selected from the CPU module.
000Eh	The module started up in the extended service mode which was temporarily selected from the CPU module.
0100h	The module started up in the normal service mode which was registered on E ² PROM.
0101h	The module started up in the parameter setting mode which was registered on E ² PROM.
010Eh	The module started up in the extended service mode which was registered on E ² PROM.
1000h	The module started up in the normal service mode which was preset with the mode setting switch.
1001h	The module started up in the parameter setting mode which was preset with the mode setting switch.
100Eh	The module started up in the extended service mode which was preset with the mode setting switch.

(14) Operation mode change request area

You can change the operation mode of the AJ71PB92D/A1SJ71PB92D by writing the required operation mode to this area and turning on the operation mode change request signal Y11. You can also specify whether that setting is registered onto E²PROM or not.

To choose the required operation mode, set any of the following values to the operation mode change request area.

(At power-on or CPU reset, the invalid value = FFFh enters the operation mode change request area. If you have accidentally turned on the operation mode change request signal Y11, the AJ71PB92D/A1SJ71PB92D detects an error and the operation mode is not changed.)

Value	Description
0000h	The operation mode is changed to the normal service mode without the mode registered onto E ² PROM.
0001h	The operation mode is changed to the parameter setting mode without the mode registered onto E ² PROM.
000Eh	The operation mode is changed to the extended service mode without the mode registered onto E ² PROM.
0100h	The operation mode is changed to the normal service mode with the mode registered onto E ² PROM.
0101h	The operation mode is changed to the parameter setting mode with the mode registered onto E ² PROM.
010Eh	The operation mode is changed to the extended service mode with the mode registered onto E ² PROM.
FFFFh	The mode preset on E ² PROM is cleared and the operation mode is changed to the mode of the mode setting switch.

If the mode setting switch setting is 0, 1 or E and the operation mode is preset on E²PROM at power-on or CPU reset, the mode setting switch setting is ignored and the operation mode preset on E²PROM is made valid.

Specifically, the operation mode after change-over is as listed below.

		"Current Operation Mode" before Operation Mode Changing								
		0000h	0001h	000Eh	0100h	0101h	010Eh	1000h	1001h	100Eh
Operation mode change request area	0000h	0000h								
	0001h	0001h								
	000Eh	000Eh								
	0100h	0100h								
	0101h	0101h								
	010Eh	010Eh								
	FFFFh	100Xh: X is the operation mode specified with the mode setting switch.						1000h	1001h	100Eh
CPU reset	(1) The mode setting switch is in the 0, 1 or E position and the mode is registered on E ² PROM = 010Xh X is the mode registered on E ² PROM.		0100h	0101h	010Eh	1000h	1001h	100Eh		
	(2) The mode setting switch is in the 0, 1 or E position and the mode is not registered on E ² PROM = 100Xh X is the mode set with the mode setting switch.									
	(3) The mode setting switch is not in the 0, 1 or E position = 0000h (Invalid. The AJ71PB92D/A1SJ71PB92D starts up in the self-diagnosis mode .)									

(15) Operation mode change result area

This area stores the execution result of the operation mode change request.

0: Normal completion.

1: Abnormal completion. (A mode change request of the unauthorized value was given.)

On abnormal completion, the AJ71PB92D/A1SJ71PB92D does not change the operation mode. It maintains the same operation mode as before the change request was given.

4.4 While-Run Operation Mode Changing Function

This function enables the operation mode of the AJ71PB92D/A1SJ71PB92D to be changed using the I/O signals X/Y and buffer memory, without resetting the CPU module.

The following I/O signals and buffer memory are used.

(1) I/O signals (Refer to Section 4.2 for details)

X11: Operation mode change completion signal

Y11: Operation mode change request signal

(2) Buffer memory (Refer to Section 4.3 for details)

Address 2254/8CEh: Current operation mode

Address 2255/8CFh: Operation mode change request area

Address 2256/8D0h: Operation mode change result area

Further, a new operation mode can be registered onto E²PROM built in the AJ71PB92D/A1SJ71PB92D by specifying it for the buffer memory.

When the operation mode has been registered onto E²PROM by this function, the AJ71PB92D/A1SJ71PB92D operates in the operation mode of E²PROM if the mode setting switch is preset to 0 (normal service mode), 1 (parameter setting mode) or E (extended service mode) at a system startup.

However, when the mode setting switch is preset to 2 (self-diagnosis mode), the AJ71PB92D/A1SJ71PB92D operates in the self-diagnosis mode.

Change the operation mode in the following procedure.

- (1) Before changing the operation mode, turn off the exchange start request signal Y00 to stop data exchange.
- (2) Set the required operation mode in the "operation mode change request area" (address 2255/8CFh) of the buffer memory.
- (3) Turn on the operation mode change request signal Y11.
- (4) The AJ71PB92D/A1SJ71PB92D changes to the requested operation mode.
- (5) The AJ71PB92D/A1SJ71PB92D turns on the operation mode change completion signal X11.
- (6) As X11 has turned on, the "current operation mode" (address 2254/8CEh) and "operation mode change result area" (address 2256/8D0h) of the buffer memory are read to confirm that the operation mode has changed.

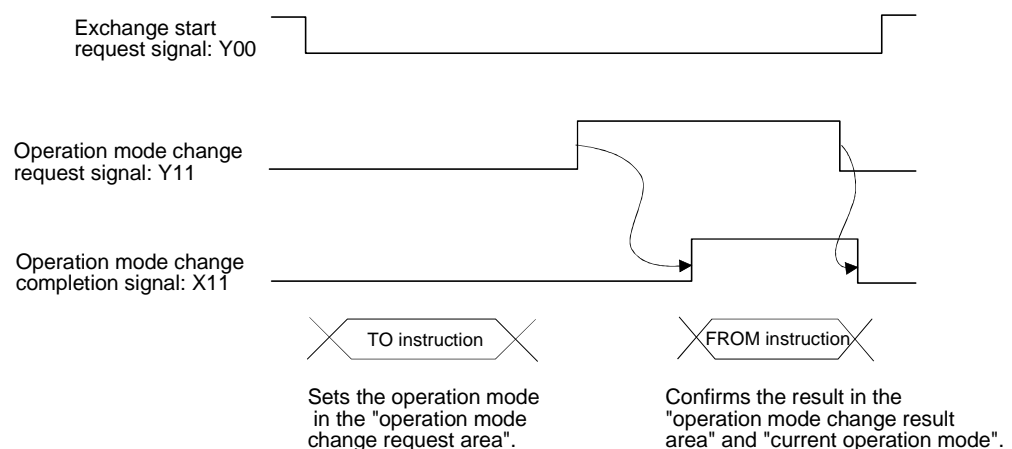

4.5 AJ71PB92D/A1SJ71PB92D's Remote Parameter Setting Function Using MELSEC ProfiMap Configuration Software

When the AJ71PB92D/A1SJ71PB92D and MELSEC ProfiMap (Ver. 3.0 or later) are used together, MELSEC ProfiMap enables remote parameter setting via the RS-422/RS-232 connector of the CPU module and via the MELSECNET/10.

For details of this function, refer to the MELSEC ProfiMap (Ver. 3.0 or later) manual.

4.6 E²PROM initialization function

This function clears the parameters stored in the E2PROM of the AJ71PB92D/A1SJ71PB92D. When the LED of the AJ71PB92D/A1SJ71PB92D indicates an error (FAULT LED: on, RSP ERR. LED: off), initialize the parameters with this function.

Re-set the AJ71PB92D/A1SJ71PB92D parameters after executing this function.

The operation for this function is as described below.

Some E²PROM initialization operations have time restrictions.

Start the E²PROM initialization operations after confirming the following points.

- (1) Power off the CPU module.**
- (2) Using the mode setting switch, perform the following operations in Steps 1) to 7) to initialize the E²PROM.**
 - 1) Set the mode setting switch to "9" and power on the CPU module.
 - 2) The FAULT LED turns on for four seconds and then turns off.
 - 3) While the FAULT LED is off (within four seconds), set the mode setting switch to "F".
If the mode setting switch position is not changed within four seconds after the FAULT LED has turned off, E²PROM initialization is canceled.
 - 4) The FAULT LED turns on for four seconds and then turns off.
 - 5) While the FAULT LED is off (within four seconds), set the mode setting switch to "A".
If the mode setting switch position is not changed within four seconds after the FAULT LED has turned off, E²PROM initialization is canceled.
 - 6) The B0 LED to B6 LED turn on, indicating that E²PROM initialization has started.
 - 7) When the B0 LED to B6 LED turn off, E²PROM initialization is completed.
- (3) Set the mode setting switch to "1" and switch the power on again or reset the CPU module.**
- (4) When the PRM SET LED turns on, E²PROM initialization is normally completed.**

(The AJ71PB92D/A1SJ71PB92D has returned to the initial status.)

If the PRM SET LED does not turn on, please consult your sales representative.

5. PROCEDURES BEFORE SYSTEM OPERATION

5.1 Procedures before Operation

The procedure for newly connecting AJ71PB92D/A1SJ71PB92D to an existing PROFIBUS-FMS network is explained below.

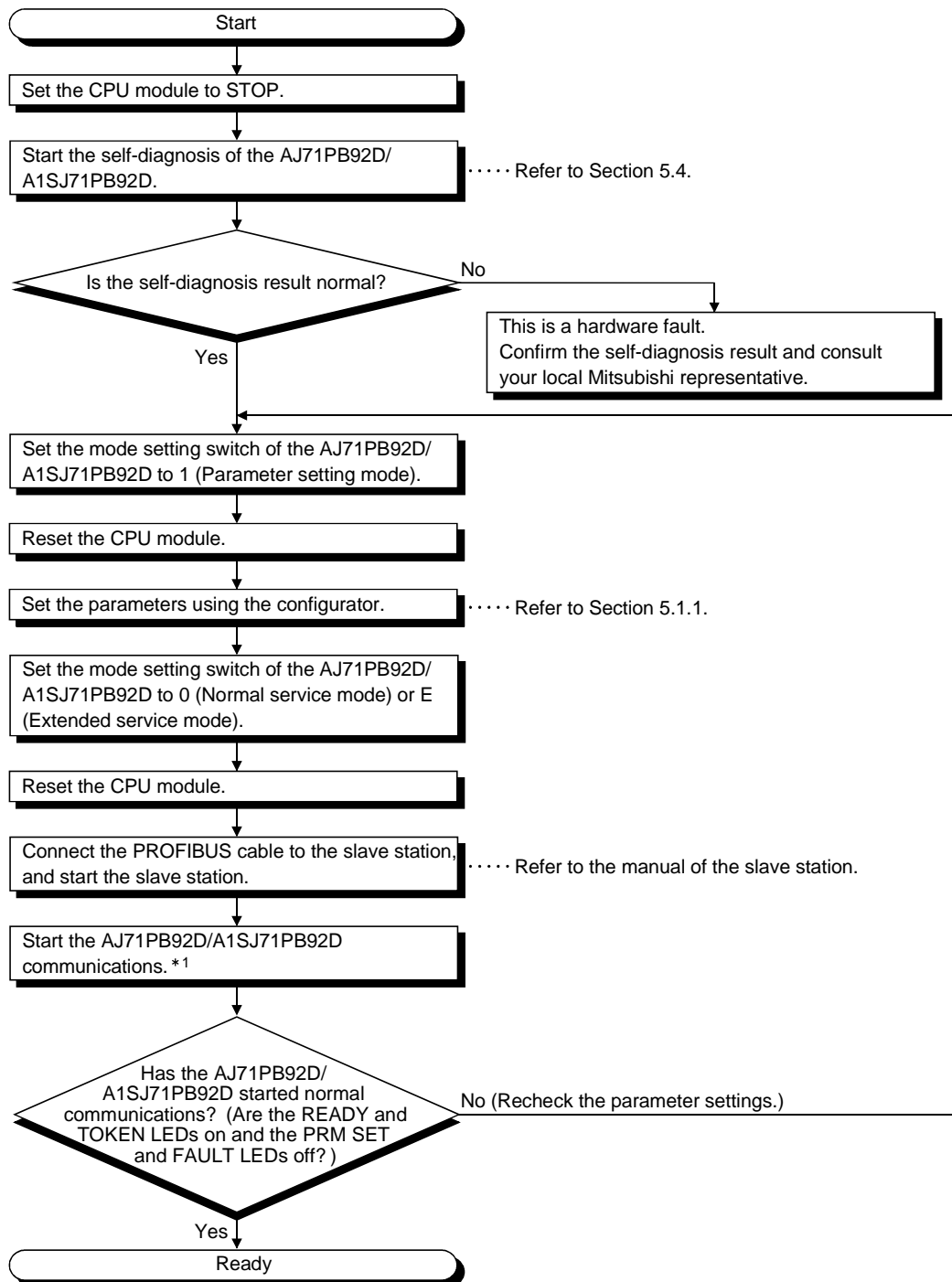

*1: Start communications in either of the following methods.
 • Turn on the exchange start request signal (Y00).
 • Start from the configurator.

5.1.1 Parameter setting procedure

The procedure for setting the AJ71PB92D/A1SJ71PB92D parameters is described below.

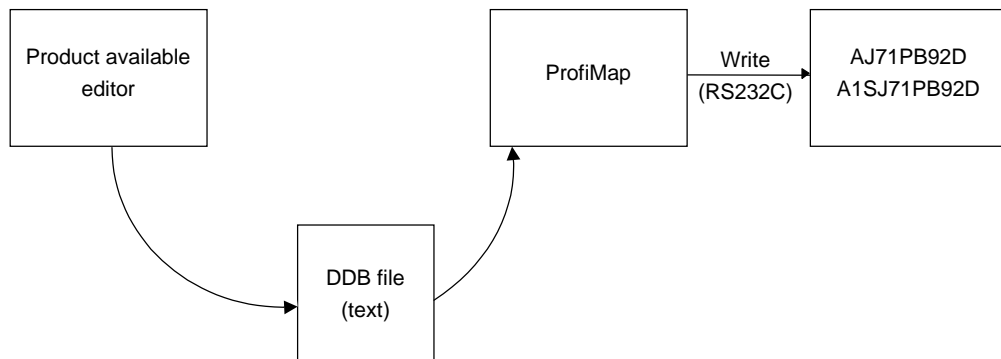

Max ST delay resp (Max Tsdr), Quiet Time (Tqui), Setup Time (Tset) in the parameter to be set by the configurator ProfiMap must be match the maximum value connected to the network, including master station.

The value of the AJ71PB92D/A1SJ71PB92D is shown below.

	Below 187.5Kbps	500Kbps	1.5Mbps	3Mbps	6Mbps	12Mbps
Max Tsdr	60	100	150	250	450	800
Tqui	0	0	0	3	6	9
Tset	1	1	1	4	8	16

5.2 Handling Precautions

This section explains handling precautions for A1SJ71PB92D.

CAUTION

- Use the module in the environment given in the general specifications of the CPU module's User's Manual. Using the module outside the range of the general specifications may result in electric shock, fire or malfunctioning, or may damage or degrade the module.
- Do not touch the conductive area or the electronic parts of the module. Doing so may cause malfunctioning or breakdowns.
- Switch all phases of the external power supply of the PLC system off before connecting the PROFIBUS cable. Not doing so could cause failure or malfunction of the module.
- Be careful not to let foreign matter such as filling or wire chips get inside the module. These can cause fire, breakdowns and malfunctioning.
- Never disassemble or modify the module.
This may cause breakdowns, malfunctioning, injury and/or fire.
- Insert the tabs at the bottom of the module into the mounting holes in the base unit before installing the module. (The AnS series module shall be fastened by screws in the base unit at the specified torque.)
Not installing the module correctly could result in malfunctioning, breakdown or pieces of the product falling.
- Switch all phases of the external power supply off before mounting or removing the module. If you do not switch off the external power supply, it will cause breakdowns or malfunction of the module.
- Set the ON/OFF select switch of the terminal resistor before the operation.
If the setting is switched during the operation, network error may occur, or error detection may not be performed by error.
- Before handling the module, always touch a grounded metal to discharge the static electricity from the human body.
A failure to do so can cause the module to fail or malfunction.

- (1) **The AJ71PB92D/A1SJ71PB92D's case is made of resin, so be careful not to drop it or strike it hard.**
- (2) **The module fixing screw (M4) fastening torque should be tighten within the range of 78.4 to 117.6N-cm**

5.3 Part Names and Settings

Following is an explanation of the AISJ71PB92D part names and settings.

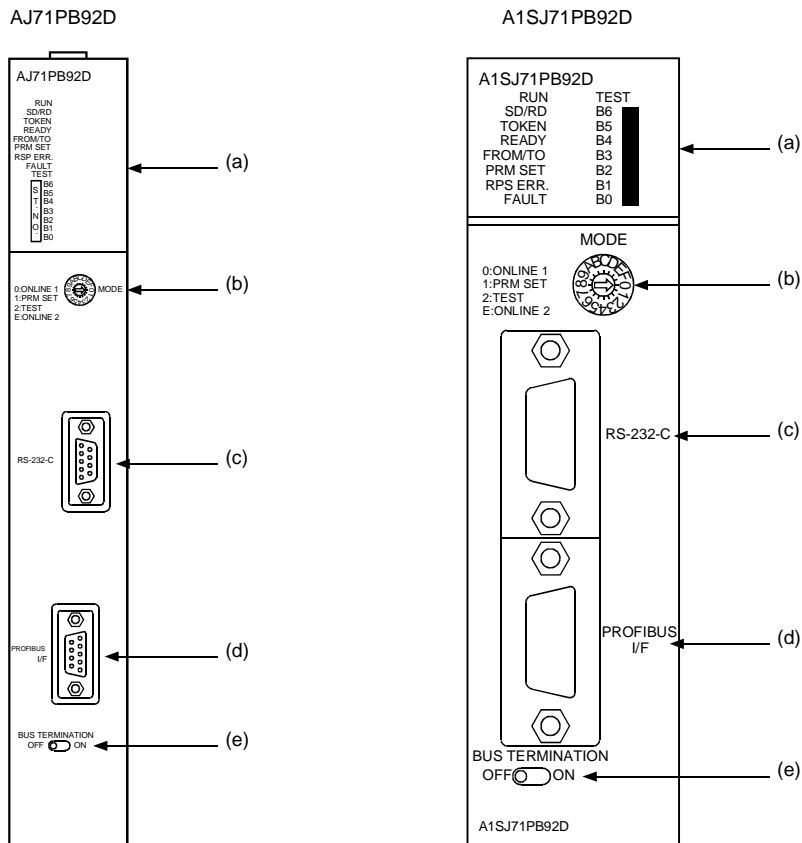

No.	Name	Description	Remark
(a)	LED	Displays the AJ71PB92D/A1SJ71PB92D status.	
		Name	Display description
		RUN	Displays the AJ71PB92D/A1SJ71PB92D operation status. ON: During normal operation OFF: When there is an error
		SD/RD	Flashing during communication with the slave station on the PROFIBUS network. The flashing interval is the one set to Data control time of the Master Parameter.
		TOKEN	Turns on when token is maintained.
		READY	Turns on when the PROFIBUS-DP network subscription preparation is completed and during subscription.
		FROM/TO	Turns on when a FROM/TO instruction from the PLC CPU.
		PRM SET	Turns on (PARAMETER SET), when the parameter setting mode. When flashing during normal operation, the parameter is not written.
		RPS ERR.	Turns on when communication error is occurred.
		FAULT	Turns on when an error occurs.
		TEST	Turns on when a self-diagnosis is executing.
	B0 to B6	Displays the station address during normal operation (Binary). Displays the test type during a self-diagnosis.	—

No.	Name	Description	Remark
(b)	Mode setting switch	This sets the AJ71PB92D/A1SJ71PB92D operation status. (at time of shipment: 0)	—
		Switch No. MODE	
		0 ONLINE 1 (Normal service mode) (refer to Section 4.3.2(1), (2))	
		1 Parameter setting mode	
		2 Self-diagnosis mode (refer to section 5.4)	
		3 to 8 Not usable	
		9, A E ² PROM function (refer to Section 4.6)	
		B to D Not usable	
		E ONLINE 2 (Extended service mode) (refer to Section 4.3.2 (1), (2))	
F E ² PROM initialization function (refer to Section 4.6)			
(c)	RS-232C interface connector	Connector for connecting the peripheral equipment that conduct the AJ71PB92D/A1SJ71PB92D parameter setting.	*1
(d)	PROFIBUS interface connector	Connector for connecting the table for the PROFIBUS-DP network.	*2
(e)	PROFIBUS network terminal resistance setting switch *3	This sets whether or not there is terminal resistance inside the AJ71PB92D/A1SJ71PB92D. (at time of shipment: OFF) ON: has terminal resistance OFF: no terminal resistance	Always ON for both ends of the station on the PROFIBUS-DP network.

*1: Use the RS-232C cable packed with MELSEC ProfiMap.

*2: For the connector type, use a male D-Sub 9 pin. The user creates the PROFIBUS cable. (for information regarding the cable wiring, refer to Item 5.5.)
The size of the screw which can be used for the connector is as follows. # 4-40 UNC.

*3: Operate the PROFIBUS network terminating resistor setting switch with your fingertips. Do not use a screwdriver or similar tool. To do so may damage the switch.

5.4 Execution Method for Self-diagnosis

This section covers the procedure for entering the self-diagnosis mode and the LED displays descriptions.

A self-diagnosis is automatically performed by setting the rotary switch to 2 and starting up (using the power supply on or reset switch).

During an internal diagnosis the LED display corresponds to the B0 to B6 statuses and the test responses being conducted are shown below.

Meaning		B6	B5	B4	B3	B2	B1	B0	TEST
(a) MPU test	During test	○	○	○	○	○	●	●	●
	Error	●	○	○	○	○	●	○	●
(b) Timer test	During test	○	○	○	○	●	○	●	●
	Error	●	○	○	○	●	○	○	●
(c) Interrupt test	During test	○	○	○	○	●	●	●	●
	Error	●	○	○	○	●	●	○	●
(d) DRAM test	During test	○	○	○	●	○	●	●	●
		○	○	○	●	●	○	●	●
	Error	●	○	○	●	●	●	○	●

○ : Turned off ● : Turned on

When the test results are normal, tests (a) to (d) are repeated. If an error is detected, then the LED status at the time the error occurs for that test will be displayed.

5.5 Wiring

5.5.1 PROFIBUS cable wiring

This section explains the wiring to PROFIBUS connector for the AJ71PB92D/A1SJ71PB92D

(1) Pin assignments for the connector

Pin No.	Symbol	Name	Application
1		SHIELD	Shield, Protective Ground
2		RP *1	Reserved for Power
3	B/B'	RxD/TxD-P	Receive/Transmit Data-P
4		CNTR-P *1	Control-P
5	C/C'	DGND	Data Ground
6		VP *2	Voltage-Plus
7		RP *1	Reserved for Power
8	A/A'	RxD/TxD-N	Receive/Transmit Data-N
9		CNTR-N *1	Control-N

*1: Signal is optional.

*2: When the terminal resistance value of building into is made it is, signal is used.

Wiring is not needed.

(2) Wiring

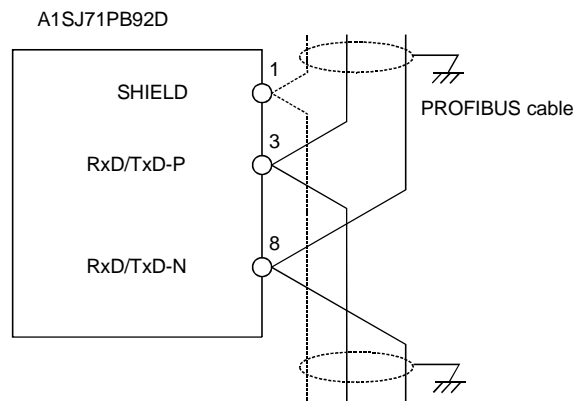

Remark

- To apply to the EMC standard:
Read the Section for the Installation in the A1S/A2SCPU User's Manual (Hardware) (after the IB-66468-E)
- Please use the PROFIBUS cable with braided shield.

5.5.2 Terminator switch

- (1) Whether or not to set the built-in module terminal resistance (1/2W 220 Ω x 2 units) can be selected by connecting a switch. (The stations on both ends of the PROFIBUS segment must be connected with terminal resistor.)

Silk display	ON	OFF
TERMINATOR	Connects terminal resistor	Disconnects terminal resistor (setting at time of shipment)

- (2) When the AJ71PB92D/A1SJ71PB92D's bus termination switch is set to on (has terminal resistor), do not remove the PROFIBUS cable from the AJ71PB92D/A1SJ71PB92D during PROFIBUS-DP network operation. If the cable is removed, then the terminal resistor in the network will disappear, causing an error and bringing down the network.

5.5.3 Precautions against wiring

As one of the requirements to give full play to AJ71PB92D/A1SJ71PB92D's functions and make up the system with high reliability, it is necessary to have an external wiring unsusceptible to an influence of noise. Precautions against external wiring of AJ71PB92D/A1SJ71PB92D is described below.

- (1) Do not route the wire of AJ71PB92D/A1SJ71PB92D close to or bundle it together with the main circuit and high-tension lines, or the load-carrying lines from other than the PLC. Otherwise, the module may be susceptible to an influence of noise and surge induction.
- (2) Keep the wires from the input/output modules of the PLC away from the communication cable as much as possible as shown below.

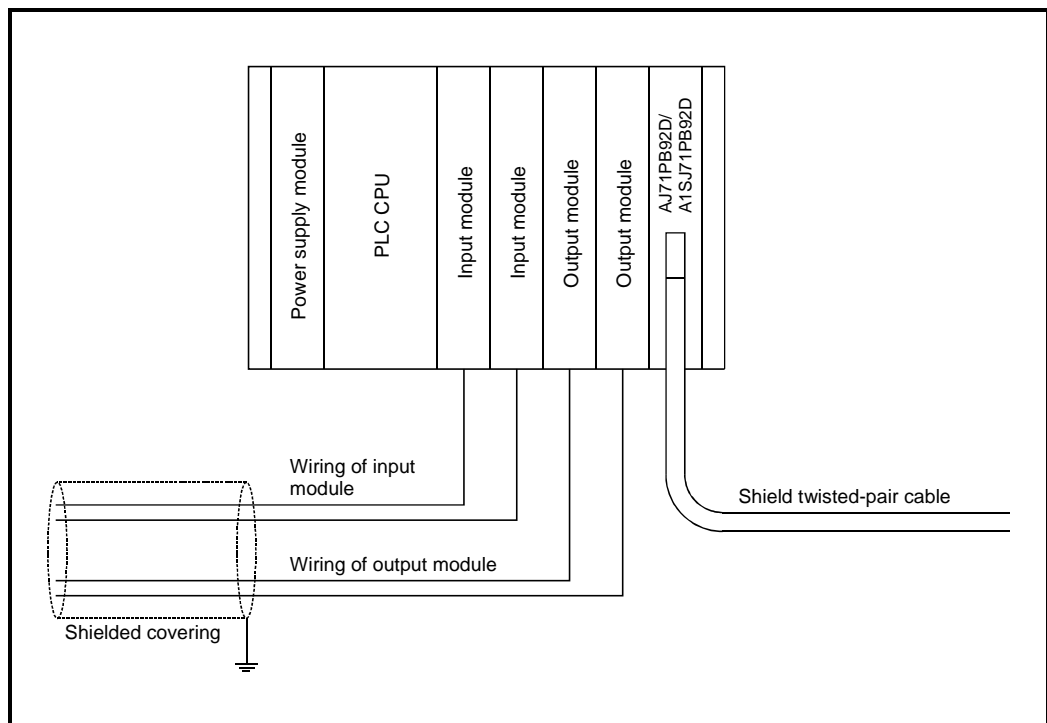

(3) Grounding

- (a) When using the AJ71PB92D/A1SJ71PB92D, ground the FG and LG terminals of the power supply module of the PLC.
- (b) If communication cannot be performed after grounding because of abnormal voltage applied to the FG terminal, the module may be used without grounding.

- (4) When the AJ71PB92D/A1SJ71PB92D's BUS TERMINATION SWITCH is set to on (has terminal resistor), do not remove the PROFIBUS cable from the AJ71PB92D/A1SJ71PB92D during PROFIBUS-DP network operation. If the cable is removed, then the terminal resistor in the network will disappear, causing an error and bringing down the network.**

5.6 Maintenance and Inspection

For the AJ71PB92D/A1SJ71PB92D, eliminate the check of cable connection and looseness and do not include it as an inspection item. Otherwise, follow the inspection item instructions in the PLC CPU User's Manual to always use the system in good condition.

DANGER

- Switch all phases of the external power supply off before cleaning. Not doing so could cause failure or malfunction of the module.

CAUTION

- Never disassemble or modify the module.
This may cause breakdowns, malfunctioning, injury and/or fire.
- Switch all phases of the external power supply off before mounting or removing the module. If you do not switch off the external power supply, it will cause failure or malfunction of the module.
- Do not touch the conductive area or the electronic parts of the module.
Doing so may cause malfunctioning or breakdowns.

6. COMMUNICATION TIME

6.1 Transmission Delay Time When There is One Master Station

An explanation of the transmission delay time when there is one master station is given in the following diagram. The following diagram (Fig. 6.1) shows an example for when there are 3 slave stations.

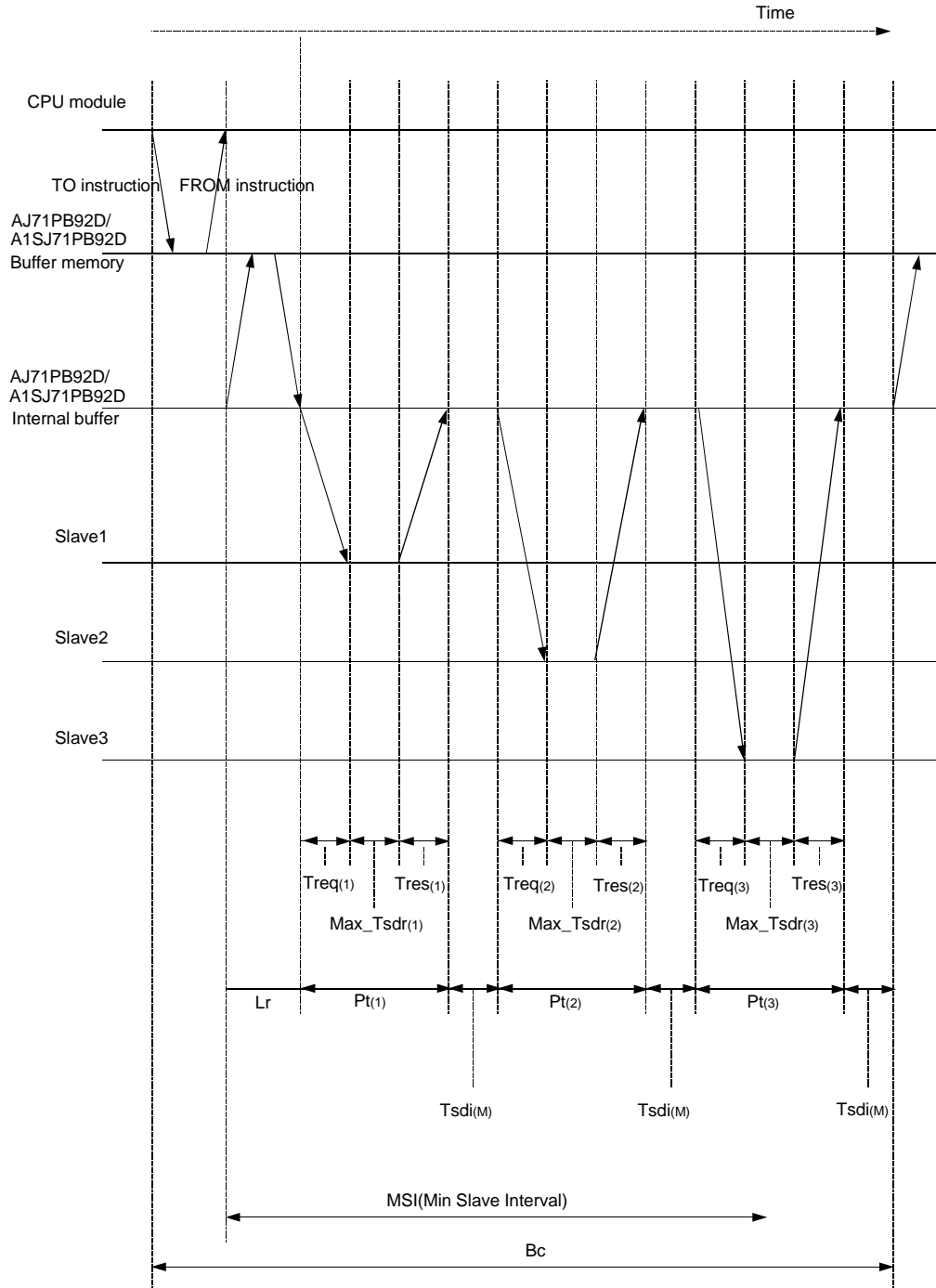

Fig. 6.1 The transmission delay time when there is one master station

Calculate the bus cycle time (Bc) of the master station with the following expression.
The symbols within [] indicate units.

$$Bc[s] = \text{Max} (MSI, \sum_{i=1}^n (Pt_{(i)} + Tsd_{i(M)}) + Lr + \text{From/To_time})$$

n = number of slave stations

Max (A, B) = A or B, whichever is greater

- (a) MSI[s] = Minimum polling cycle (Min. slave interval)*1
*1: Value set on the "Master Setting" screen of MELSEC ProfiMAP or GX Configurator-DP
- (b) Pt_(i) [s] = (Polling time of No. i station) = Treq_(i) + Max_Tsdr_(i) + Tres_(i)
 - 1) Treq_(i) [s] = Request transmission time of No. i station
= { (Number of bytes output to No. i station) + 9 } × 11 [bit] / (transmission speed[bps])
 - 2) Max_Tsdr_(i) [s] = (response time [T_{Bit}] of No. i station)*2, *3 / (transmission speed[bps])
*2: MaxTsdr value described in the GSD (DDB) file of the slave station.
*3: [T_{Bit}] (Bit Time) is a unit that expresses the time required for 1-bit data transmission as "1".
The actual processing time varies as described below depending on the transmission speed.
[1.5Mbps]
1 [T_{Bit}] = 1 / (1.5 × 10⁶) = 0.667 [μs]
[12Mbps]
1 [T_{Bit}] = 1 / (12 × 10⁶) = 0.083 [μs]
 - 3) Tres_(i) [s] = (Response transmission time of No. 1 station)
= { (Number of bytes input from No. i station) + 9 } × 11 [bit] / (transmission speed[bps])
- (c) Tsd_(M) [s] = (Request/response processing time [T_{Bit}] of master station (AJ71PB92D/A1SJ71PB92D)) *4 / (transmission speed[bps])

*4: Tsd_i value described in the GSD (DDB) file of the AJ71PB92D/A1SJ71PB92D.
The Tsd_i value varies as described below depending on the transmission speed.
Refer to *3 for the unit [T_{Bit}].

	Transmission speed [bps]								
	9.6k	19.2k	93.75k	197.5k	500k	1.5M	3M	6M	12M
Request/response processing time [T _{Bit}] of master station	10	15	15	80		150			

- (d) Lr[s] = (data refresh time)
= 1.2 × 10⁻³ + { (number of slave stations) × 1.2 × 10⁻⁶ }
- (e) From/To_time[s] = (time necessary for FROM/TO instruction)
= (number of FROM/TO instruction execution times within one sequence scan) × 3.3 × 10⁻³

Point

In Fig. 6.1, the FROM/TO instruction and bus cycle time are drawn as if they are synchronous, but they are actually asynchronous.
If the buffer memory data are overwritten by the TO instruction during the bus cycle time, the overwritten buffer memory values are transferred to the internal buffer at the next transfer time.

The calculation example of the bus cycle time is shown below.

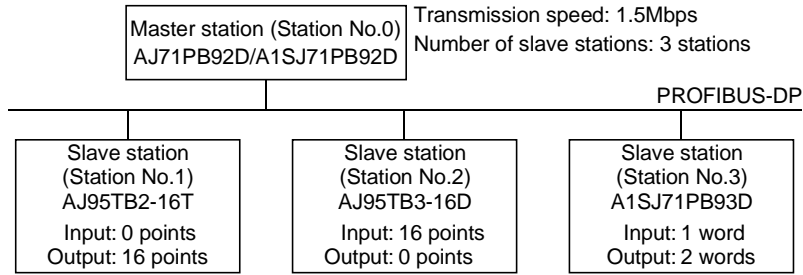

	AJ95TB2-16T	AJ95TB3-16D	A1SJ71PB93D
Output data size [byte]	2	0	4
Input data size [byte]	0	2	2

(a) MSI[s] value

$$MSI[s] = 20 \times 100 \times 10^{-6} = 2.0 \times 10^{-3}$$

(b) $Pt_{(i)}$ [s] value

Item	Slave station		
	AJ95TB2-16T (Station No.1)	AJ95TB3-16D (Station No.2)	A1SJ71PB93D (Station No.3)
1) $Treq_{(i)}$ [s]	$\{ (2 + 9) \times 11 \} / (1.5 \times 10^6)$ $= 0.081 \times 10^{-3}$	$\{ (0 + 9) \times 11 \} / (1.5 \times 10^6)$ $= 0.066 \times 10^{-3}$	$\{ (4 + 9) \times 11 \} / (1.5 \times 10^6)$ $= 0.095 \times 10^{-3}$
Response time [T _{Bit}] of No. i station	150	150	150
2) $Max_Tsd_{r(i)}$ [s]	$150 / (1.5 \times 10^6) = 0.1 \times 10^{-3}$	$150 / (1.5 \times 10^6) = 0.1 \times 10^{-3}$	$150 / (1.5 \times 10^6) = 0.1 \times 10^{-3}$
3) $Tres_{(i)}$ [s]	$\{ (0 + 9) \times 11 \} / (1.5 \times 10^6)$ $= 0.066 \times 10^{-3}$	$\{ (2 + 9) \times 11 \} / (1.5 \times 10^6)$ $= 0.081 \times 10^{-3}$	$\{ (2 + 9) \times 11 \} / (1.5 \times 10^6)$ $= 0.081 \times 10^{-3}$
$Pt_{(i)}$ [s]	$0.081 \times 10^{-3} + 0.1 \times 10^{-3} + 0.066 \times 10^{-3}$ $= 0.247 \times 10^{-3}$	$0.1 \times 10^{-3} + 0.066 \times 10^{-3} + 0.081 \times 10^{-3}$ $= 0.247 \times 10^{-3}$	$0.095 \times 10^{-3} + 0.1 \times 10^{-3} + 0.081 \times 10^{-3}$ $= 0.276 \times 10^{-3}$

(c) $Tsdi_{(M)}$ [s] value

Request/response processing time [T_{Bit}] of master station (AJ71PB92D/A1SJ71PB92D)
 $Tsdi_{(M)}[s] = 150 / (1.5 \times 10^6) = 0.1 \times 10^{-3}$

(d) Lr [s] value

$$Lr[s] = 1.2 \times 10^{-3} + (3 \times 1.2 \times 10^{-6}) = 1.20 \times 10^{-3}$$

(e) From/To_time[s] value

Number of FROM/TO instruction execution times within one sequence scan = 2
 $From/To_time[s] = 2 \times 3.3 \times 10^{-3} = 6.6 \times 10^{-3}$

From the values in (b) to (e)

$$\begin{aligned} \sum_{i=1}^3 (Pt_{(i)} + Tsdi_{(M)}) + Lr + From/To_time &= \{ (Pt_{(1)} + Tsdi_{(M)}) + (Pt_{(2)} + Tsdi_{(M)}) + (Pt_{(3)} + Tsdi_{(M)}) \} + Lr + From/To_time \\ &= \{ (0.347 \times 10^{-3}) + (0.347 \times 10^{-3}) + (0.376 \times 10^{-3}) \} + 1.20 \times 10^{-3} + 6.6 \times 10^{-3} \\ &= 1.07 \times 10^{-3} + 1.20 \times 10^{-3} + 6.6 \times 10^{-3} \\ &= 8.87 \times 10^{-3} \end{aligned}$$

Hence, the bus cycle time (Bc) value is as follows.

$$\begin{aligned} Bc[s] &= \text{Max} (MSI, \sum_{i=1}^3 (Pt_{(i)} + Tsd_{i(M)}) + Lr + \text{From/To_time}) \\ &= \text{Max} (2.0 \times 10^{-3}, 8.87 \times 10^{-3}) \\ &= 8.87 \times 10^{-3} [s] \end{aligned}$$

6.2 Transmission Delay Time When There are Multiple Master Stations

The follow explains the transmission delay time when multiple master stations are connected to the same network.

The following diagram (Fig. 6.2) shows the example where two master stations are connected to the same network.

Bc(1) and Bc(2) in the following diagram (Fig. 6.2) are the bus cycle times of the master station 1 and master station 2, respectively, and their transmission delay time is calculated using the formula presented in Section 6.1.

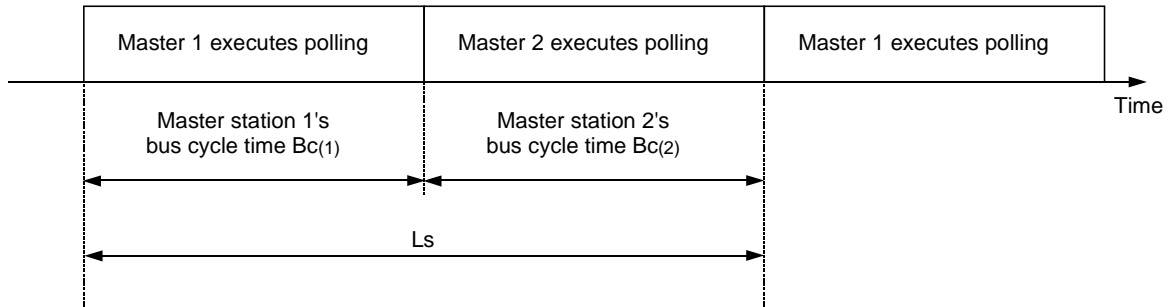

Fig. 6.2 The transmission delay time when multiple masters are connected

As shown in this diagram, each master 1 link scan time is calculated as:

$$Ls = \sum_{n=1}^{\text{Number of the master stations}} Bc(n)$$

7. DDB FILE

The DDB file for the AJ71PB92D/A1SJ71PB92D is required to create the communication parameter for the AJ71PB92D/A1SJ71PB92D with the configurator. A product available editor is used to create the following contents for the DDB file.

File name: PB92F036.GSD

```

; *****
;
; Device Data Base for A1SJ71PB92D
; *****
;

# Profibus_DP

Vendor_Name      = "MITSUBISHI ELECTRIC CORPORATION"
Model_Name       = "A1SJ71PB92D"
Revision         = "AA"
Ident_Number     = 0xF036
Protocol_Ident   = 0
Station_Type     = 1
FMS_supp        = 0
Hardware_Release = "A"
Software_Release = "A"

9.6_supp        = 1
19.2_supp       = 1
93.75_supp      = 1
187.5_supp      = 1
500_supp        = 1
1.5M_supp       = 1
3M_supp         = 1
6M_supp         = 1
12M_supp        = 1

MaxTsd_9.6      = 60
MaxTsd_19.2     = 60
MaxTsd_93.75   = 60
MaxTsd_187.5   = 60
MaxTsd_500     = 100
MaxTsd_1.5M    = 150
MaxTsd_3M      = 250
MaxTsd_6M      = 450
MaxTsd_12M     = 800

Redundancy      = 0
Repeater_Ctrl_Sig = 0
24V_Pins        = 0

Download_supp   = 0
Upload_supp     = 0
Act_Para_Brct_supp = 0
Act_Param_supp   = 0

Max_MPS_Length  = 32736
Max_Lsdu_MS     = 244
Max_Lsdu_MM     = 244
Min_Poll_Timeout = 50

```

Trdy_9.6	= 1
Trdy_19.2	= 1
Trdy_93.75	= 1
Trdy_187.5	= 1
Trdy_500	= 1
Trdy_1.5M	= 1
Trdy_3M	= 1
Trdy_6M	= 1
Trdy_12M	= 1
Tqui_9.6	= 0
Tqui_19.2	= 0
Tqui_93.75	= 0
Tqui_187.5	= 0
Tqui_500	= 0
Tqui_1.5M	= 0
Tqui_3M	= 3
Tqui_6M	= 6
Tqui_12M	= 9
Tset_9.6	= 1
Tset_19.2	= 1
Tset_93.75	= 1
Tset_187.5	= 1
Tset_500	= 1
Tset_1.5M	= 1
Tset_3M	= 4
Tset_6M	= 8
Tset_12M	= 16
LAS_Len	= 127
Tsdi_9.6	= 10
Tsdi_19.2	= 15
Tsdi_93.75	= 15
Tsdi_187.5	= 80
Tsdi_500	= 80
Tsdi_1.5M	= 150
Tsdi_3M	= 150
Tsdi_6M	= 150
Tsdi_12M	= 150
Max_Slaves_supp	= 126

8. PROGRAMMING

A programming example is detailed below.

In this example, the AJ71PB92D/A1SJ71PB92D is attached to the No.0 slot on the base unit.

When diverting the program example introduced in this chapter to the actual system, fully check that there are no problems in the controllability of the system.

8.1 Initial Program

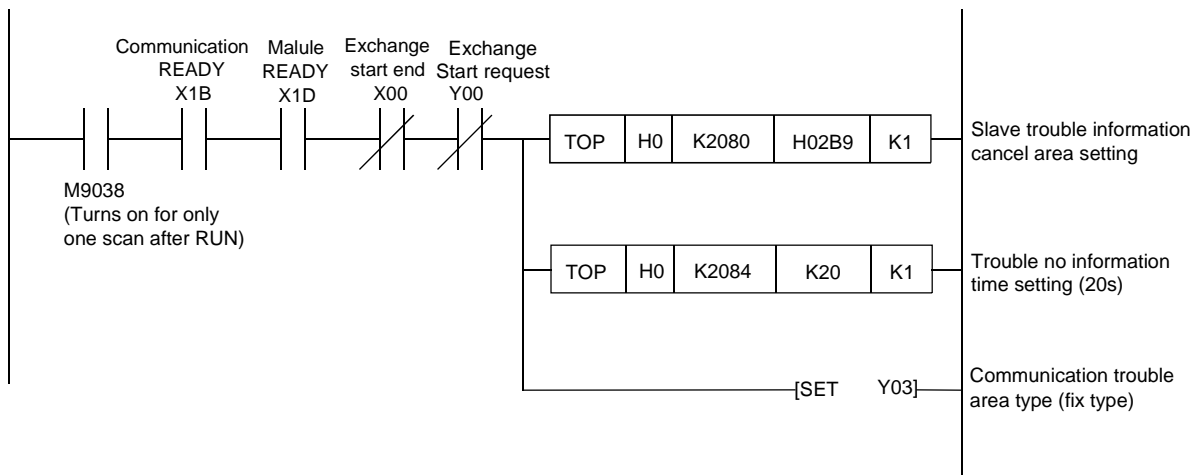

8.2 Data I/O with Slave

8.2.1 Normal service mode (MODE switch : No. 0)

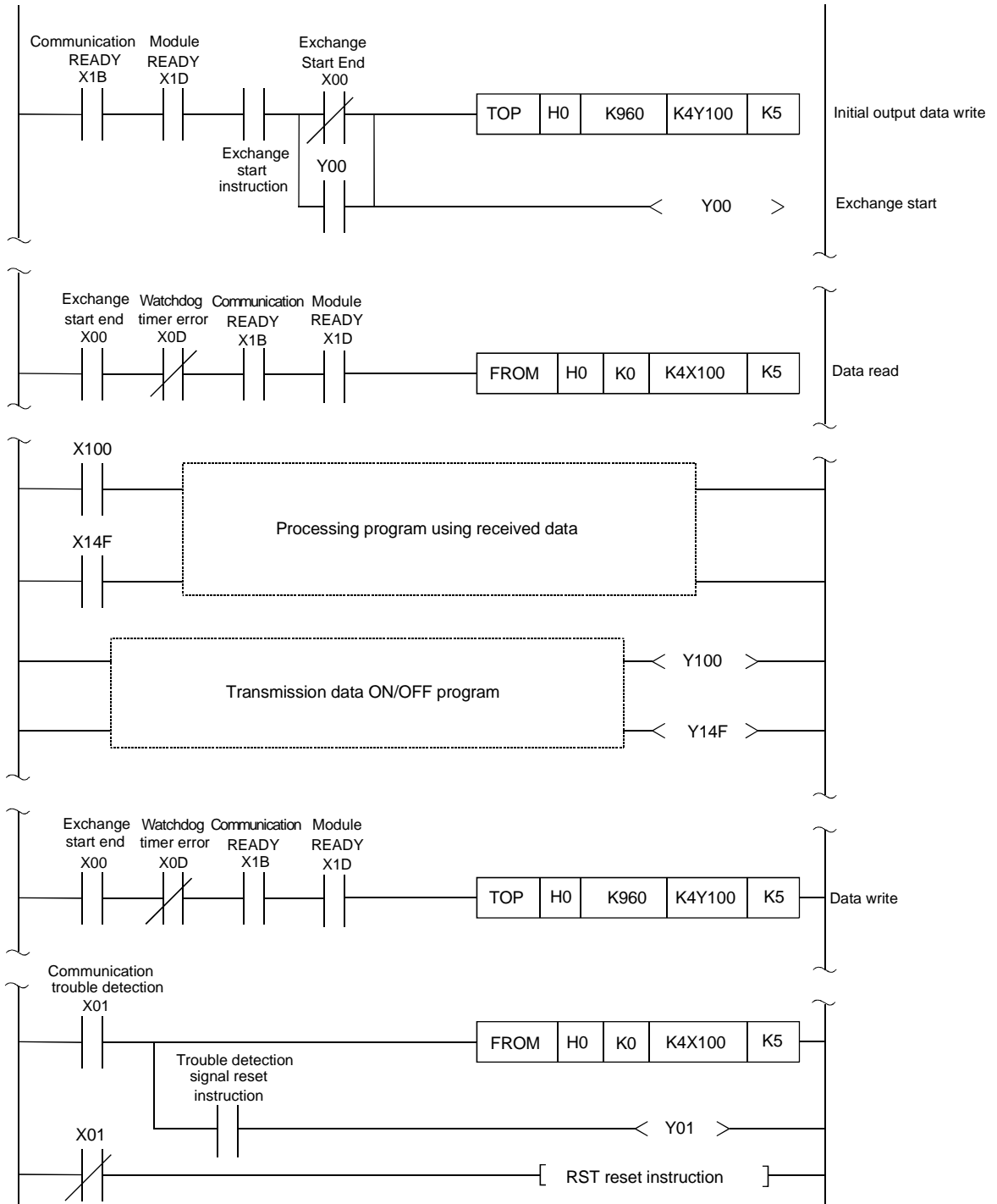

Point

Pay attention to the increase of the scan time since it will take at least 3.3ms to process the FROM/TO instruction.
 It is recommended to perform the FROM/TO instruction for the AJ71PB92D/A1SJ71PB92D only once in each sequence scan.

8.2.2 Extend service mode (MODE switch : No. E)

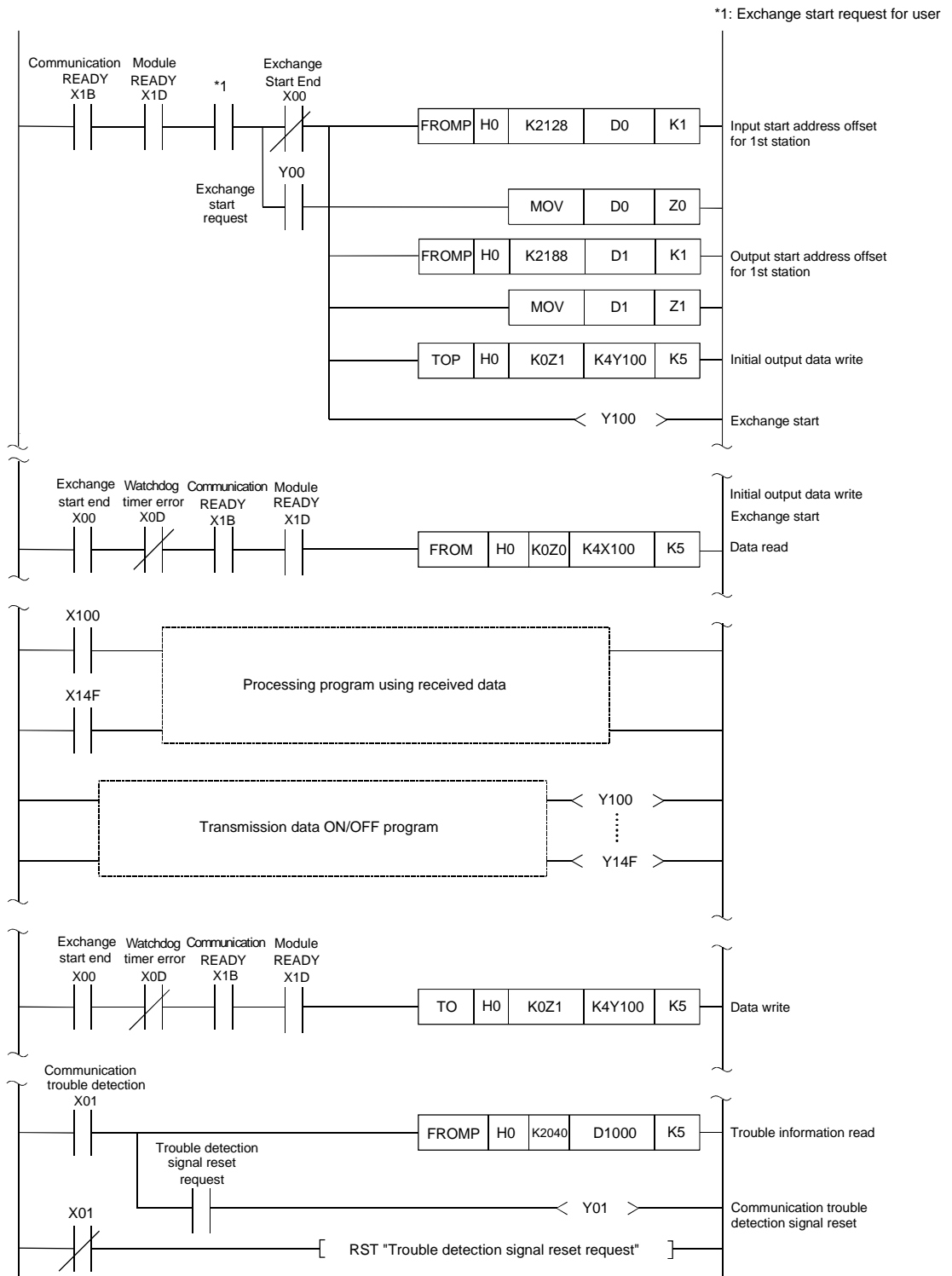

Point
(1) Pay attention to the increase of the scan time since it will take at least 3.3ms to process the FROM/TO instruction. It is recommended to perform the FROM/TO instruction for the AJ71PB92D/A1SJ71PB92D only once in each sequence scan.
(2) If the network configuration allows the power supplies to the A1SJ71PB92D and to the slave station to be on simultaneously, there may be cases in which the slave side is not completely started at the time the X1B turns on. In this case, consider the time lag for the slave station to completely start up when estimating the time period from the point the X1B turns on until the communication start "Y00" turns on.

8.3 Communication Trouble Area and Expansion Communication Trouble Area Clear

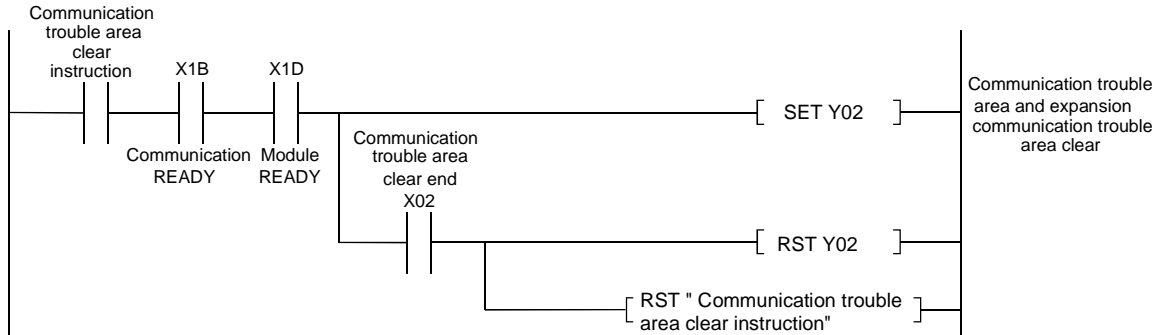

8.4 Address Information Read

Example: When reading the No.1 station address

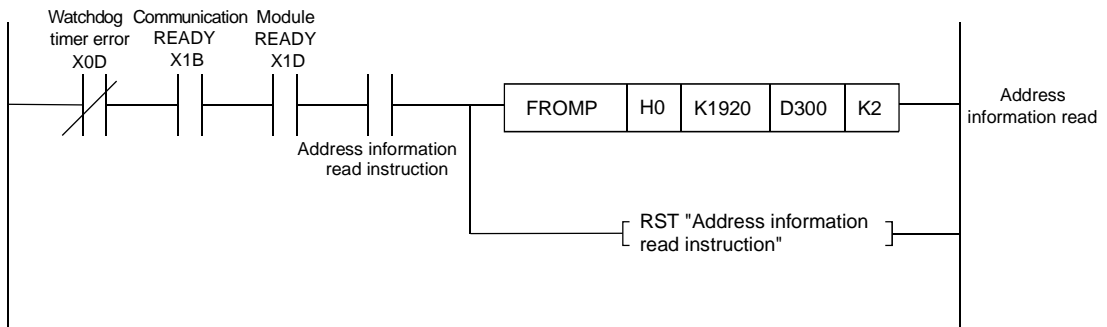

8.5 Global Control

Following is shown an example of when a global control service (SYNC) is transmitted to each slave station in groups 1 and 2. (For information regarding service commands refer to Section 4.3.2.9.)

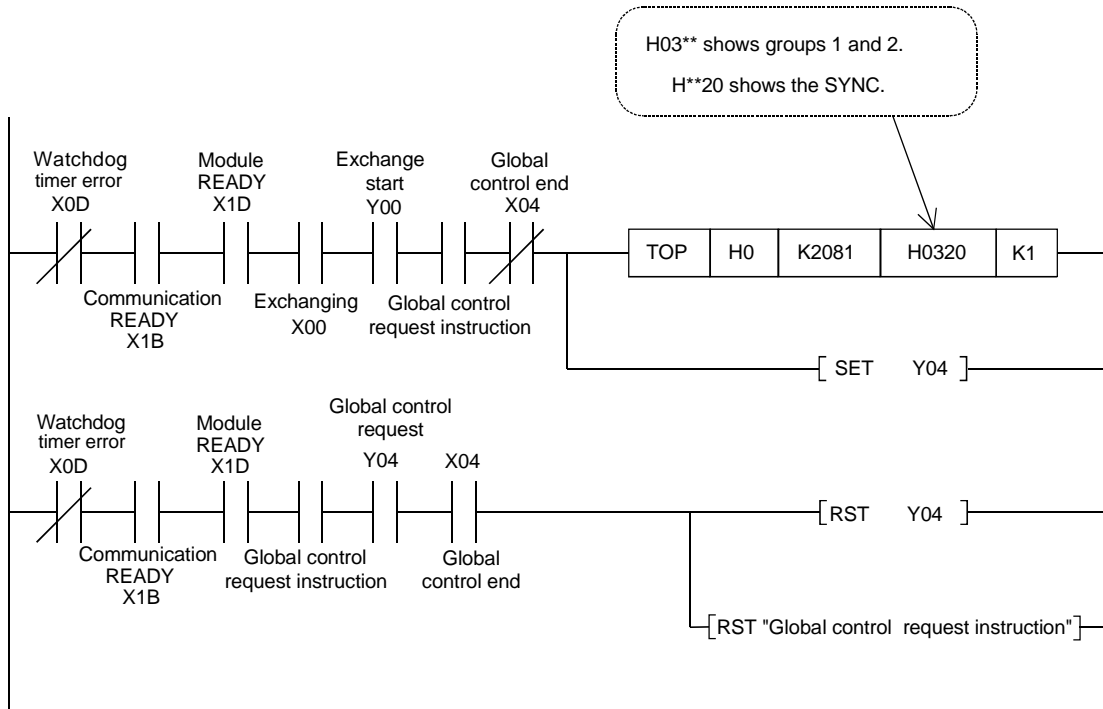

8.6 While-Run Operation Mode Changing

The operation mode is changed by writing "0000h" (the operation mode is changed to the normal operation mode without the mode registered onto E²PROM) to the operation mode change request area of the buffer memory.

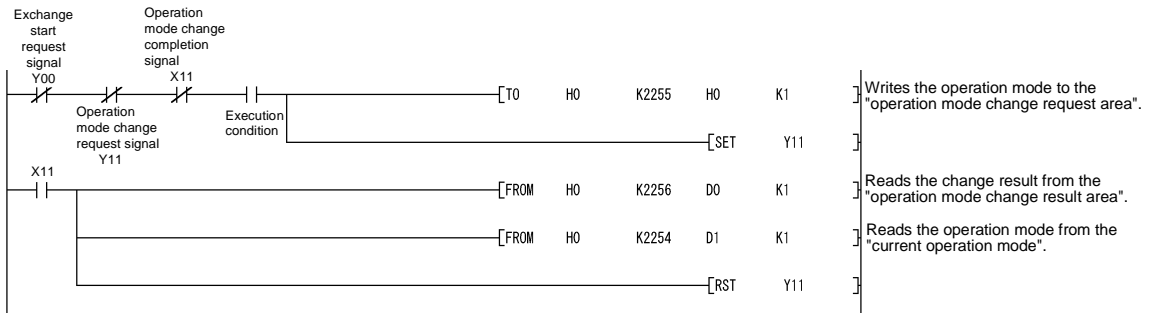

9. TROUBLESHOOTING

This chapter explains the troubleshooting for the use of the A1SJ71PB92D.

LED		Definition		Measures
RUN	On	Normal	—	—
	Off	Abnormal	The watchdog timer timed out.	Contact the nearest service center or dealer.
READY	On	Normal in mode 0 or E	—	—
		Abnormal in other than mode 0 or E	Offline or did not enter the self-diagnosis mode.	Contact the nearest service center or dealer.
	Off	Normal in other than mode 0 or E	—	—
		Abnormal in mode 0 or E	Did not enter the online mode.	Contact the nearest service center or dealer.
SD/RD	On	Abnormal	There is a slave station with which initialization exchange cannot be done. (The parameter and actual slave station do not match.)	Check the parameter.
	Flash	Normal	—	—
	Off	Abnormal in mode 0 or E	No exchange	Check the exchange start request signal Y00.
TOKEN	On	Normal	—	—
	Flash	Normal	Multi-master configuration in mode 0 or E	—
	Off	Normal in other than mode 0 or E	—	—
		Abnormal in mode 0 or E	Token does not cycle.	<ul style="list-style-type: none"> • Check the cable and terminal resistor. • Check for duplicate addresses. • Check if the HSA exceeds the network maximum station No.
PRM SET	On	Normal in mode 1	—	—
	Flash	Abnormal	No parameter written in the module.	Write the parameter in the module.
			The E ² PROM parameters are corrupted.	Initialize the E ² PROM with the E ² PROM initialization function. (Refer to Section 4.6)
	Off	Normal	—	—
RSP ERR. FAULT	The error definition varies with the combination of the RSP ERR. LED and FAULT LED states. Refer to the following table for details.			

The following table indicates the error definitions of the AJ71PB92D/A1SJ71PB92D that change depending on the combination of the RSP ERR. LED and FAULT LED states.

RSP ERR.	FAULT	Definition	Measures
On	On	There is a slave station that has the same address as that of the master station in the parameter.	Correct the parameter.
	Off	<ul style="list-style-type: none"> • An abnormal station identified. • A communication trouble identified. 	Refer to the communication trouble information of the buffer memory.
Off	On	<ul style="list-style-type: none"> • The parameter meaning no active slave stations exist was written and Y0 was turned on. • The parameter for the slave station whose station number is the same as that of the master station was written, and Y0 was turned on. 	Re-set the parameter.
		The E ² PROM parameters are corrupted.	Initialize the E ² PROM with the E ² PROM initialization function. (Refer to Section 4.6)
		Any other unexpected error occurred.	Contact the nearest service center or dealer.
	Off	Normal	—

APPENDIX

Appendix 1 Differences between AJ71PB92D/A1SJ71PB92D Software Versions

Appendix 1.1 Differences between A1SJ71PB92D Software Versions

(1) The extended service mode and slave station status indication area were added to the software version E.

Buffer Memory	Software Version E or Later	Software Version D or Earlier
Address: 0 to 959	<ul style="list-style-type: none"> Input area Normal service mode: 32 bytes, fixed length Extended service mode: 244 bytes, variable length 	<ul style="list-style-type: none"> Input area Normal service mode: 32 bytes, fixed length
Address: 960 to 1919	<ul style="list-style-type: none"> Output area Normal service mode: 32 bytes, fixed length Extended service mode: 244 bytes, variable length 	<ul style="list-style-type: none"> Output area Normal service mode: 32 bytes, fixed length
Address: 2112 to 2116	<ul style="list-style-type: none"> Slave status area (The status of each slave station is indicated.) 	<ul style="list-style-type: none"> Not usable
Address: 2128 to 2247 (Extended service mode only)	<ul style="list-style-type: none"> I/O start address area (The I/O area starting address of each slave station is indicated.) 	<ul style="list-style-type: none"> Not usable

As the software version E or later uses the extended service mode, the new setting position "No. E" was added to the MODE setting switch.

If the MODE setting switch on the A1SJ71PB92D of the software version D or earlier is set to No. E, we cannot guarantee its operation. Do not set the MODE setting switch of the software version D or earlier to No. E.

(2) The operation mode changing function and MELSEC ProfiMap's remote parameter function were added to the software version G.

Buffer Memory	Software Version G or Later	Software Version F or Earlier
Address: 2254	<ul style="list-style-type: none"> Current operation mode (The current operation mode is indicated.) 	<ul style="list-style-type: none"> Not usable
Address: 2255	<ul style="list-style-type: none"> Operation mode change request area (Set the required operation mode.) 	<ul style="list-style-type: none"> Not usable
Address: 2256	<ul style="list-style-type: none"> Operation mode change result area (The operation mode change request result is indicated.) 	<ul style="list-style-type: none"> Not usable

I/O Signal	Software Version G or Later	Software Version F or Earlier
X10	<ul style="list-style-type: none"> Operation mode signal 	<ul style="list-style-type: none"> Not usable
X11	<ul style="list-style-type: none"> Operation mode change completion signal 	<ul style="list-style-type: none"> Not usable
Y11	<ul style="list-style-type: none"> Operation mode change request signal 	<ul style="list-style-type: none"> Not usable

MELSEC ProfiMap	Software Version G or Later	Software Version F or Earlier
Remote parameter function	<ul style="list-style-type: none"> Can be set. 	<ul style="list-style-type: none"> Cannot be set.

Appendix 1.2 Restrictions on Use of A1SJ71PB92D Software Versions in the Same System

(1) Differences between the software versions are whether new functions were added or not.

Use of the A1SJ71PB92D software versions in the same system will pose no problems.

In addition, replacing the old software version with a new software version will pose no problems.

Appendix 1.3 Differences between AJ71PB92D Software Versions

(1) The operation mode changing function and MELSEC ProfiMap's remote parameter function were added to the software version C.

Buffer Memory	Software Version C or Later	Software Version B or Earlier
Address: 2254	<ul style="list-style-type: none"> Current operation mode (The current operation mode is indicated.) 	<ul style="list-style-type: none"> Not usable
Address: 2255	<ul style="list-style-type: none"> Operation mode change request area (Set the required operation mode.) 	<ul style="list-style-type: none"> Not usable
Address: 2256	<ul style="list-style-type: none"> Operation mode change result area (The operation mode change request result is indicated.) 	<ul style="list-style-type: none"> Not usable

I/O Signal	Software Version C or Later	Software Version B or Earlier
X10	<ul style="list-style-type: none"> Operation mode signal 	<ul style="list-style-type: none"> Not usable
X11	<ul style="list-style-type: none"> Operation mode change completion signal 	<ul style="list-style-type: none"> Not usable
Y11	<ul style="list-style-type: none"> Operation mode change request signal 	<ul style="list-style-type: none"> Not usable

MELSEC ProfiMap	Software Version C or Later	Software Version B or Earlier
Remote parameter function	<ul style="list-style-type: none"> Can be set. 	<ul style="list-style-type: none"> Cannot be set.

Appendix 1.4 Restrictions on Use of AJ71PB92D Software Versions in the Same System

(1) Differences between the software versions are whether new functions were added or not.

Use of the A71PB92D software versions in the same system will pose no problems.

In addition, replacing the old software version with a new software version will pose no problems.

Appendix 2 Precautions for Replacing AJ71PB92 with A(1S)J71PB92D

Pay attention to the following points when replacing the AJ71PB92 with the A(1S)J71PB92D.

(1) The sequence programs and cable wiring prepared for the AJ71PB92 can be used for the A(1S)J71PB92D.

(2) The parameters for the AJ71PB92 cannot be used for the A(1S)J71PB92D due to a file format difference.

Obtain the EN50170-compliant device definition file (GSD file) for your device from the device manufacturer, and re-create the parameters using MELSEC ProfiMap or GX Configurator-DP.

(3) The parameter setting software packages used for the AJ71PB92 are not available for the A(1S)J71PB92D.

The parameter setting software packages differ between the AJ71PB92 and A(1S)J71PB92D as indicated in the following table.

Item	AJ71PB92	A(1S)J71PB92D
Parameter creation software package	Siemens COM ET 200	MELSEC ProfiMap MELSEC ProfiMap2.0
Parameter write software package	SW0IX-DPLDPE	MELSEC ProfiMap3.0 GX Configurator-DP Version 4.0 or later
Device definition file	COM ET 200-dedicated device definition file (*DT.200)	EN50170-compliant device definition file (*.gsd)
Parameter write software package connection target	RS-422 port of AJ71PB92	<ul style="list-style-type: none"> • RS-232C port of A(1S)J71PB92D • RS-422 port of CPU module (when MELSEC ProfiMap 3.0 or GX Configurator-DP is used)

(4) Though the switch setting of the AJ71PB92 was made with the rotary and DIP switches, that of the A(1S)J71PB92D is made with the rotary switch only.

The switch setting differs between the AJ71PB92 and A(1S)J71PB92D as indicated in the following table.

Switch	AJ71PB92	A(1S)J71PB92D
Rotary switch	Standard service mode Self-diagnosis mode 1 Self-diagnosis mode 2	Standard service mode Extended service mode Parameter setting mode Test mode
DIP switch	Parameter setting mode	(No switch)

(5) Some LED setting differs between the AJ71PB92 and A(1S)J71PB92D.

LED Name	AJ71PB92	A(1S)J71PB92D
SD/RD	Flashes fast during communication.	Flashes during communication with a slave station on the PROFIBUS network. The flashing interval is the time set in the "data control time" of bus parameter.
LED 1 to 8	In standard service mode: Indicates the preset transmission speed and the AJ71PB92's station number. In self-diagnosis mode: Indicates the self-diagnosis status.	(No LEDs)
B0 to B7	(No LEDs)	In standard service mode: IN extended service mode: Indicates the A(1S)J71PB92D's station number. In self-diagnosis mode: Indicates the self-diagnosis status.
TEST	(No LEDs)	In self-diagnosis mode: On In other modes: Off

(6) The 5VDC internal current consumption and weight differ between the AJ71PB92 and A(1S)J71PB92D.

However, since the both values of the A(1S)J71PB92D are smaller than those of the AJ71PB92, power supply module replacement, base unit mounting screw reinforcement, etc. are not necessary.

LED Name	AJ71PB92	AJ71PB92D	A1SJ71PB92D
5VDC internal current consumption	1.3A	0.54A	0.56A
Weight	0.5kg	0.37kg	0.27kg

(7) Resetting operation differs.

LED Name	AJ71PB92	A(1S)J71PB92D
Reset operation	The RESET switch of the module is used for reset operation.	The key switch of the PLC CPU is used for reset operation.

Remarks

The following functions have been added to the A(1S)J71PB92D.

(a) Mode

As compared to the AJ71PB92, the extended service mode (mode E) has been added*1 to the A(1S)J71PB92D. In the extended service mode, up to 244 bytes of data can be sent/received per slave station.

In the extended service mode, the layout of the I/O areas of the slave stations in the buffer memory changes depending on the sent/received data length.

*1: The extended service mode has been added to the software version E. Refer to Appendix 1.1 for details.

(b) Communication with slave station

As compared to the AJ71PB92, the global control communication function has been added to the A(1S)J71PB92D.

(c) Transmission specifications

The A(1S)J71PB92D differs in some transmission specifications from the AJ71PB92.

Item		AJ71PB92	A(1S)J71PB92D
Maximum transmission distance	Transmission speed	Not supported	100 [m/segment]
	3[Mbps]		
	6[Mbps]		
	12[Mbps]		
Setting range of host station number		1 or 2	0 to 125

(d) I/O signals

As compared to the AJ71PB92, the following I/O signals have been added to the A(1S)J71PB92D.

Input Signal	Description
X04	Global control end signal
X05	Global control error end signal
X10	Operation mode signal
X11	Operation mode change completion signal

Output Signal	Description
Y04	Global control request signal
Y11	Operation mode change request signal

(e) Buffer memory

As compared to the AJ71PB92, the following buffer memory areas have been added or modified to the A(1S)J71PB92D.

Buffer Memory Address (Decimal/hexadecimal)	Addition/Modification	Explanation
0 / 0h 959 / 3BFh	Modification	Input area In the A(1S)J71PB92D, the layout of the input areas of the slave stations changes depending on the received data length in the extended service mode only. In the normal service mode, the layout of the input areas is the same as that of the AJ71PB92.
960 / 3C0h 1919 / 77Fh	Modification	Output area In the A(1S)J71PB92D, the layout of the output areas of the slave stations changes depending on the sent data length in the extended service mode only. In the normal service mode, the layout of the output areas is the same as that of the AJ71PB92.
2081 / 821h	Addition	Global control area
2084 / 824h	Addition	Trouble no information time setting area
2096 / 830h 2110 / 83Eh	Addition	Expansion communication trouble area
2112 / 840h 2116 / 844h	Addition	Slave status area
2128 / 850h 2247 / 8C7h	Addition	Input/Output start address area (Extended service mode only)
2254 / 8CEh	Addition	Current operation mode
2255 / 8CFh	Addition	Operation mode change request area
2256 / 8D0h	Addition	Operation mode change result area

Appendix 3 Extended Trouble Information of Mitsubishi's Slaves

(1) AJ95TB2-16T

AJ95TB2-16T notifies device-related trouble information to the master. The information consists of seven bytes including the header (one byte) as shown below:

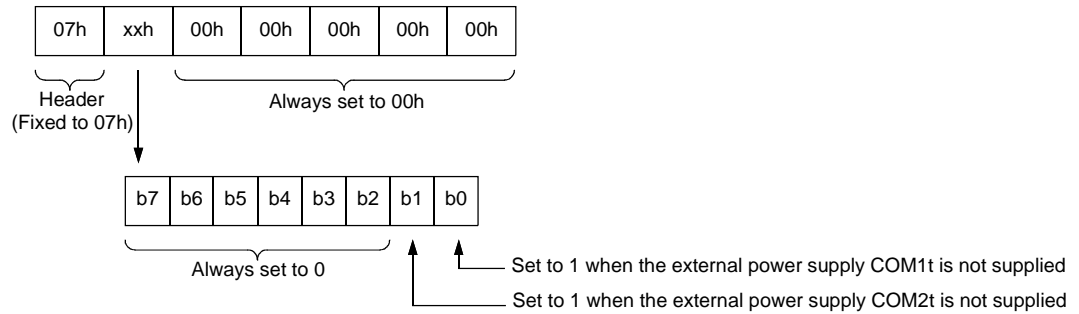

(2) AJ95TB32-16DT

AJ95TB32-16DT notifies device-related trouble information to the master. The information consists of seven bytes including the header (one byte) as shown below:

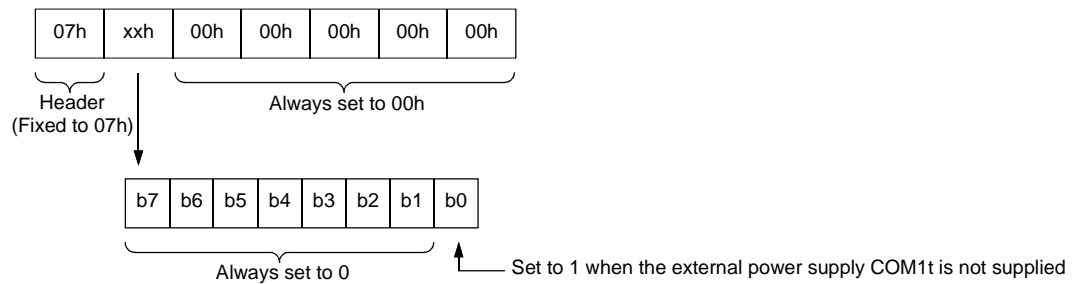

(3) AJ95TB3-16D

AJ95TB3-16D notifies device-related trouble information to the master. The information consists of seven bytes including the header (one byte) as shown below:

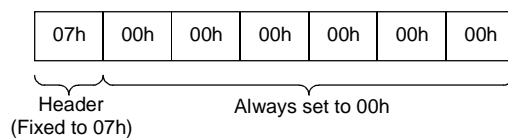

Appendix 4 External Dimensions

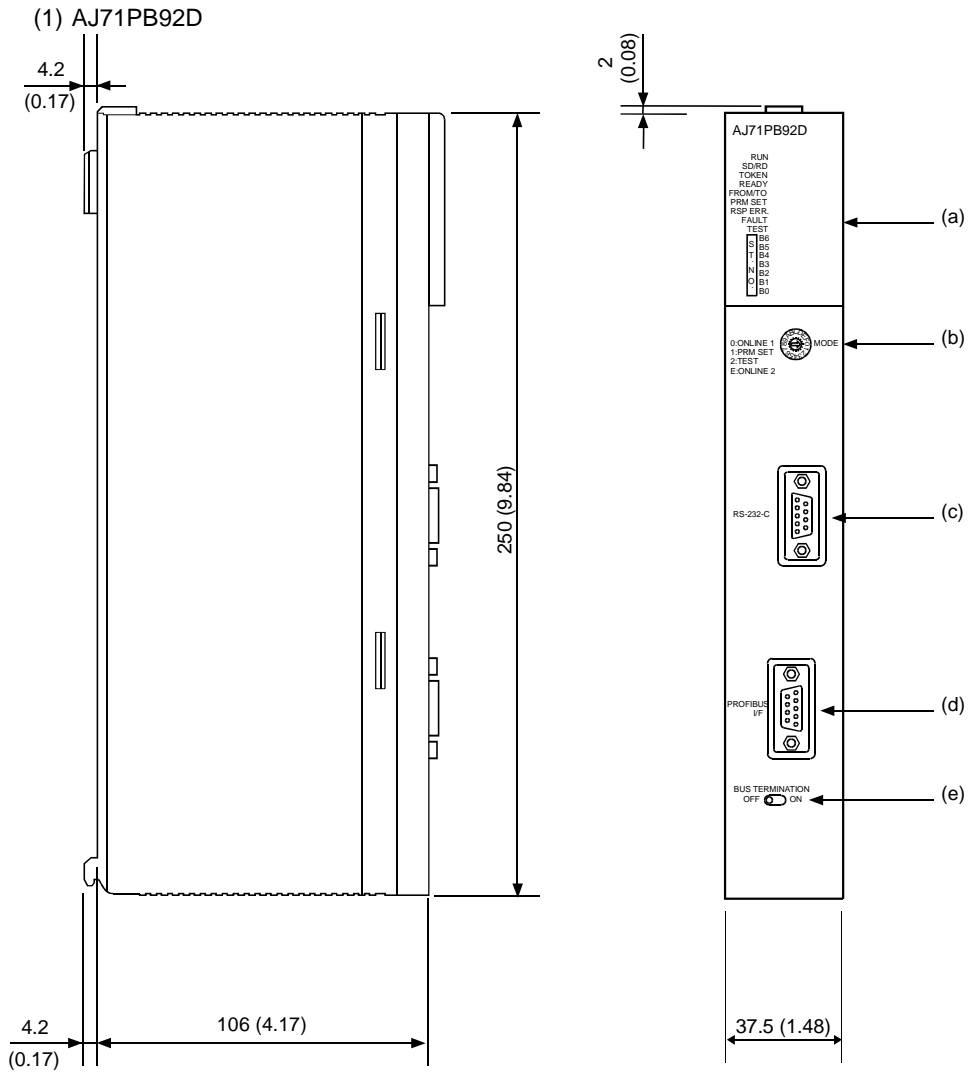

Unit : mm (inch)

(2) A1SJ71PB92D

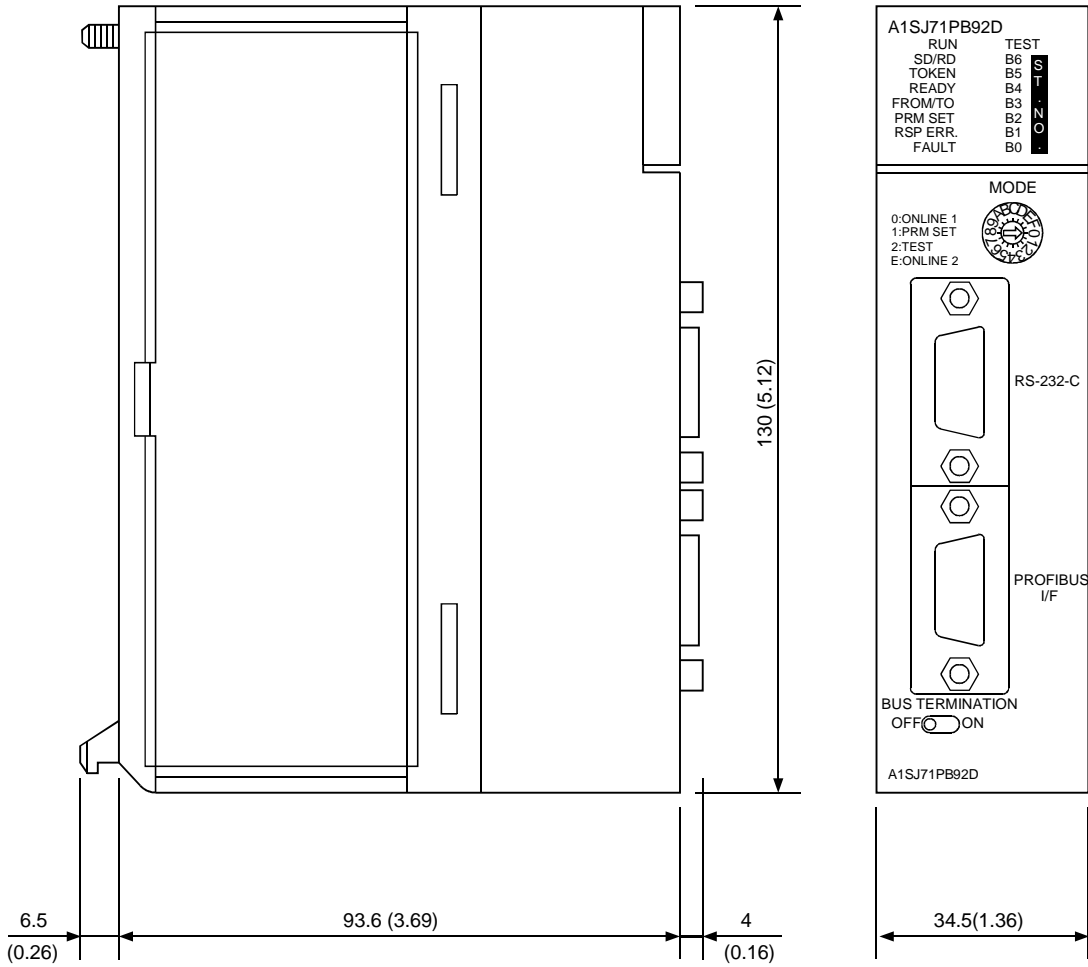

Unit : mm (inch)

WARRANTY

Please confirm the following product warranty details before using this product.

1. Gratis Warranty Term and Gratis Warranty Range

If any faults or defects (hereinafter "Failure") found to be the responsibility of Mitsubishi occurs during use of the product within the gratis warranty term, the product shall be repaired at no cost via the sales representative or Mitsubishi Service Company.

However, if repairs are required onsite at domestic or overseas location, expenses to send an engineer will be solely at the customer's discretion. Mitsubishi shall not be held responsible for any re-commissioning, maintenance, or testing on-site that involves replacement of the failed module.

[Gratis Warranty Term]

The gratis warranty term of the product shall be for one year after the date of purchase or delivery to a designated place.

Note that after manufacture and shipment from Mitsubishi, the maximum distribution period shall be six (6) months, and the longest gratis warranty term after manufacturing shall be eighteen (18) months. The gratis warranty term of repair parts shall not exceed the gratis warranty term before repairs.

[Gratis Warranty Range]

- (1) The range shall be limited to normal use within the usage state, usage methods and usage environment, etc., which follow the conditions and precautions, etc., given in the instruction manual, user's manual and caution labels on the product.
- (2) Even within the gratis warranty term, repairs shall be charged for in the following cases.
 1. Failure occurring from inappropriate storage or handling, carelessness or negligence by the user. Failure caused by the user's hardware or software design.
 2. Failure caused by unapproved modifications, etc., to the product by the user.
 3. When the Mitsubishi product is assembled into a user's device, Failure that could have been avoided if functions or structures, judged as necessary in the legal safety measures the user's device is subject to or as necessary by industry standards, had been provided.
 4. Failure that could have been avoided if consumable parts (battery, backlight, fuse, etc.) designated in the instruction manual had been correctly serviced or replaced.
 5. Failure caused by external irresistible forces such as fires or abnormal voltages, and Failure caused by force majeure such as earthquakes, lightning, wind and water damage.
 6. Failure caused by reasons unpredictable by scientific technology standards at time of shipment from Mitsubishi.
 7. Any other failure found not to be the responsibility of Mitsubishi or that admitted not to be so by the user.

2. Onerous repair term after discontinuation of production

- (1) Mitsubishi shall accept onerous product repairs for seven (7) years after production of the product is discontinued. Discontinuation of production shall be notified with Mitsubishi Technical Bulletins, etc.
- (2) Product supply (including repair parts) is not available after production is discontinued.

3. Overseas service

Overseas, repairs shall be accepted by Mitsubishi's local overseas FA Center. Note that the repair conditions at each FA Center may differ.

4. Exclusion of loss in opportunity and secondary loss from warranty liability

Regardless of the gratis warranty term, Mitsubishi shall not be liable for compensation of damages caused by any cause found not to be the responsibility of Mitsubishi, loss in opportunity, lost profits incurred to the user by Failures of Mitsubishi products, special damages and secondary damages whether foreseeable or not, compensation for accidents, and compensation for damages to products other than Mitsubishi products, replacement by the user, maintenance of on-site equipment, start-up test run and other tasks.

5. Changes in product specifications

The specifications given in the catalogs, manuals or technical documents are subject to change without prior notice.

6. Product application

- (1) In using the Mitsubishi MELSEC programmable logic controller, the usage conditions shall be that the application will not lead to a major accident even if any problem or fault should occur in the programmable logic controller device, and that backup and fail-safe functions are systematically provided outside of the device for any problem or fault.
- (2) The Mitsubishi programmable logic controller has been designed and manufactured for applications in general industries, etc. Thus, applications in which the public could be affected such as in nuclear power plants and other power plants operated by respective power companies, and applications in which a special quality assurance system is required, such as for Railway companies or Public service purposes shall be excluded from the programmable logic controller applications.

In addition, applications in which human life or property that could be greatly affected, such as in aircraft, medical applications, incineration and fuel devices, manned transportation, equipment for recreation and amusement, and safety devices, shall also be excluded from the programmable logic controller range of applications.

However, in certain cases, some applications may be possible, providing the user consults their local Mitsubishi representative outlining the special requirements of the project, and providing that all parties concerned agree to the special circumstances, solely at the users discretion.

Microsoft, Windows, Windows NT are registered trademarks of Microsoft Corporation in the United States and other countries.

Other company names and product names used in this document are trademarks or registered trademarks of respective companies.

HEADQUARTERS		EUROPEAN REPRESENTATIVES		EUROPEAN REPRESENTATIVES		EUROPEAN REPRESENTATIVES	
MITSUBISHI ELECTRIC EUROPE B.V. German Branch Gothaer Straße 8 D-40880 Ratingen Phone: +49 (0)2102 486-0 Fax: +49 (0)2102 486-1120 e mail: megfamail@meg.mee.com		EUROPE GEVA AUSTRIA Wiener Straße 89 AT-2500 Baden Phone: +43 (0)2252 / 85 55 20 Fax: +43 (0)2252 / 488 60 e mail: office@geva.at		EUROPEAN REPRESENTATIVES UAB UTU POWEL LITHUANIA Savanoriu Pr. 187 LT-2053 Vilnius Phone: +370 (0)52323-101 Fax: +370 (0)52322-980 e mail: powel@utu.lt		EUROPEAN REPRESENTATIVES CSC Automation UKRAINE 15, M. Raskova St., Fl. 10, Off. 1010 UA-02002 Kiev Phone: +380 (0)44 / 238 83 16 Fax: +380 (0)44 / 238 83 17 e mail: csc-a@csc-a.kiev.ua	
MITSUBISHI ELECTRIC EUROPE B.V. French Branch 25, Boulevard des Bouvets F-92741 Nanterre Cedex Phone: +33 1 55 68 55 68 Fax: +33 1 55 68 56 85 e mail: factory.automation@framee.com		EUROPEAN REPRESENTATIVES TEHNIKON BELARUS Oktjabrskaya 16/5, Ap 704 BY-220030 Minsk Phone: +375 (0)17 / 2104626 Fax: +375 (0)17 / 2275830 e mail: tehnikon@belsonet.net		EUROPEAN REPRESENTATIVES Intehsis Srl MOLDOVA Cuza-Voda 36/1-81 MD-2061 Chisinau Phone: +373 (0)2 / 562 263 Fax: +373 (0)2 / 562 263 e mail: intehsis@mdl.net		EURASIAN REPRESENTATIVE CONSUS RUSSIA Promyshlennaya St. 42 RU-198099 St Petersburg Phone: +7 812 / 325 36 53 Fax: +7 812 / 325 36 53 e mail: consus@consus.spb.ru	
MITSUBISHI ELECTRIC EUROPE B.V. Irish Branch Westgate Business Park, Ballymount IRL-Dublin 24 Phone: +353 (0) 1 / 419 88 00 Fax: +353 (0) 1 / 419 88 90 e mail: sales.info@meir.mee.com		EUROPEAN REPRESENTATIVES Getronics b.v. BELGIUM Control Systems Pontbeeklaan 43 BE-1731 Asse-Zellik Phone: +32 (0)2 / 467 17 51 Fax: +32 (0)2 / 467 17 45 e mail: infoautomation@getronics.com		EUROPEAN REPRESENTATIVES Getronics b.v. NETHERLANDS Control Systems Donauweg 2 B NL-1043 AJ Amsterdam Phone: +31 (0)20 / 587 6700 Fax: +31 (0)20 / 587 6839 e mail: info.gia@getronics.com		EURASIAN REPRESENTATIVE ELEKTROSTYLE RUSSIA ul. Garschina 11 RU-140070 Moscow Oblast Phone: +7 095 / 557 9756 Fax: +7 095 / 746 8880 e mail: mjuly@elektrostyle.ru	
MITSUBISHI ELECTRIC EUROPE B.V. Italian Branch Via Paracelso 12 I-20041 Agrate Brianza (MI) Phone: +39 039 60 53 1 Fax: +39 039 60 53 312 e mail: factory.automation@it.mee.com		EUROPEAN REPRESENTATIVES TELECON CO. BULGARIA 4, A. Ljapchev Blvd. BG-1756 Sofia Phone: +359 (0)2 / 97 44 058 Fax: +359 (0)2 / 97 44 061 e mail: —		EUROPEAN REPRESENTATIVES Motion Control NETHERLANDS Automation b.v. Markenweg 5 NL-7051 HS Varsseveld Phone: +31 (0)315 / 257 260 Fax: +31 (0)315 / 257 269 e mail: —		EURASIAN REPRESENTATIVE ELEKTROSTYLE RUSSIA Krasnij Prospekt 220-1, Office 312 RU-630049 Novosibirsk Phone: +7 3832 / 10 66 18 Fax: +7 3832 / 10 66 26 e mail: elo@elektrostyle.ru	
MITSUBISHI ELECTRIC EUROPE B.V. Spanish Branch Carretera de Rubí 76-80 E-08190 Sant Cugat del Vallés Phone: +34 9 3 565 3131 Fax: +34 9 3 589 2948 e mail: industrial@sp.mee.com		EUROPEAN REPRESENTATIVES INEA CR d.o.o. CROATIA Losinjska 4 a HR-10000 Zagreb Phone: +385 (0) 1 / 36 940-01 Fax: +385 (0) 1 / 36 940-03 e mail: inea@inea.hr		EUROPEAN REPRESENTATIVES Beijer Electronics AS NORWAY Teglverksveien 1 NO-3002 Drammen Phone: +47 (0)32 / 24 30 00 Fax: +47 (0)32 / 84 85 77 e mail: info@beijer.no		EURASIAN REPRESENTATIVE ICOS RUSSIA Ryazanskij Prospekt, 8A, Office 100 RU-109428 Moscow Phone: +7 095 / 232 0207 Fax: +7 095 / 232 0327 e mail: mail@icos.ru	
MITSUBISHI ELECTRIC EUROPE B.V. UK Branch Travellers Lane GB-Hatfield Herts. AL10 8 XB Phone: +44 (0) 1707 / 27 61 00 Fax: +44 (0) 1707 / 27 86 95 e mail: automation@meuk.mee.com		EUROPEAN REPRESENTATIVES AutoCont CZECH REPUBLIC Control Systems s.r.o. Nemocnici 12 CZ-70200 Ostrava 2 Phone: +420 59 / 6152 111 Fax: +420 59 / 6152 562 e mail: consys@autocont.cz		EUROPEAN REPRESENTATIVES MPL Technology Sp. z o.o. POLAND ul. Sliczna 36 PL-31-444 Kraków Phone: +48 (0)12 / 632 28 85 Fax: +48 (0)12 / 632 47 82 e mail: krakow@mpl.pl		EURASIAN REPRESENTATIVE SMENA RUSSIA Polzunova 7 RU-630051 Novosibirsk Phone: +7 095 / 416 4321 Fax: +7 095 / 416 4321 e mail: smena-nsk@yandex.ru	
MITSUBISHI ELECTRIC CORPORATION Office Tower "Z" 14 F 8-12,1 chome, Harumi Chuo-Ku Tokyo 104-6212 Phone: +81 3 622 160 60 Fax: +81 3 622 160 75		EUROPEAN REPRESENTATIVES louis poulsen DENMARK industri & automation Geminivej 32 DK-2670 Greve Phone: +45 (0)43 / 95 95 95 Fax: +45 (0)43 / 95 95 91 e mail: lpia@lpmail.com		EUROPEAN REPRESENTATIVES ACP Autocomp a.s. SLOVAKIA Chalupkova 7 SK-81109 Bratislava Phone: +421 (02)5292-2254 Fax: +421 (02)5292-2248 e mail: info@acp-autocomp.sk		EURASIAN REPRESENTATIVE SSMP Rosgidromontazh Ltd RUSSIA 23, Lesoparkovaya Str. RU-344041 Rostov On Don Phone: +7 8632 / 36 00 22 Fax: +7 8632 / 36 00 26 e mail: —	
MITSUBISHI ELECTRIC AUTOMATION 500 Corporate Woods Parkway Vernon Hills, IL 60061 Phone: +1 847 478 21 00 Fax: +1 847 478 22 83		EUROPEAN REPRESENTATIVES UTU POWEL OY FINLAND Box 236 FIN-28101 Porri Phone: +358 (0)2 / 550 800 Fax: +358 (0)2 / 550 8841 e mail: tehoelektroniikka@urhotuominen.fi		EUROPEAN REPRESENTATIVES Sirius Trading & Services srl ROMANIA Str. Biharia Nr. 67-77 RO-013981 Bucuresti 1 Phone: +40 (0) 21 / 201 1146 Fax: +40 (0) 21 / 201 1148 e mail: sirius@siriustrading.ro		EURASIAN REPRESENTATIVE STC Drive Technique RUSSIA Poslannikov per., 9, str.1 RU-107005 Moscow Phone: +7 095 / 786 21 00 Fax: +7 095 / 786 21 01 e mail: info@privod.ru	
		EUROPEAN REPRESENTATIVES UTECO A.B.E.E. GREECE 5, Mavrogenous Str. GR-18542 Piraeus Phone: +302 (0)10 / 42 10 050 Fax: +302 (0)10 / 42 12 033 e mail: uteco@uteco.gr		EUROPEAN REPRESENTATIVES Beijer Electronics AB SWEDEN Box 426 S-20124 Malmö Phone: +46 (0)40 / 35 86 00 Fax: +46 (0)40 / 35 86 02 e mail: info@beijer.de		EURASIAN REPRESENTATIVE SHERF Motion Techn. Ltd ISRAEL Rehov Hamerkava 19 IL-58851 Holon Phone: +972 (0)3 / 559 54 62 Fax: +972 (0)3 / 556 01 82 e mail: —	
		EUROPEAN REPRESENTATIVES Meltrade Automatika Kft. HUNGARY 55, Harmat St. HU-1105 Budapest Phone: +36 (0)1 / 2605 602 Fax: +36 (0)1 / 2605 602 e mail: office@meltrade.hu		EUROPEAN REPRESENTATIVES ECONOTEC AG SWITZERLAND Postfach 282 CH-8309 Nürensdorf Phone: +41 (0)1 / 838 48 11 Fax: +41 (0)1 / 838 48 12 e mail: info@econotec.ch		AFRICAN REPRESENTATIVE CBI Ltd SOUTH AFRICA Private Bag 2016 ZA-1600 Isando Phone: +27 (0)11 / 928 2000 Fax: +27 (0)11 / 392 2354 e mail: cbi@cbi.co.za	
		EUROPEAN REPRESENTATIVES SIA POWEL LATVIA Lienes iela 28 LV-1009 Riga Phone: +371 784 2280 Fax: +371 784 2281 e mail: utu@utu.lv		EUROPEAN REPRESENTATIVES GTS TURKEY Darülaceze Cad. No. 43A KAT: 2 TR-80270 Okmeydani-Istanbul Phone: +90 (0)212 / 320 1640 Fax: +90 (0)212 / 320 1649 e mail: gts@turk.net			