

# MITSUBISHI

## A1S62TCRT-S2 Heating-Cooling Temperature Control Module A1S62TCRTBW-S2 Heating-Cooling Temperature Control Module with Wire Breakage Detection Function

### Mitsubishi General-Purpose Programmable Controller **User's Manual** (Hardware)

Thank you for purchasing the Mitsubishi general-purpose programmable controller MELSEC-A series.

Prior to use, please read this manual thoroughly and familiarize yourself with the product.



Type	A1S62TCRT-U-HW-E
Type Code	13JL33
IB(NA)-66801-C(0210)MEE	

© 1997 MITSUBISHI ELECTRIC CORPORATION

### ● SAFETY PRECAUTIONS ●

(Read these precautions before using.)

When using Mitsubishi equipment, thoroughly read this manual and the associated manuals introduced in the manual. Also, pay careful attention to safety and handle the module properly.

These precautions apply only to Mitsubishi equipment. Refer to the CPU module user's manual for a description of the PC system safety precautions.

These ●SAFETY PRECAUTIONS● classify the safety precautions into two categories: "DANGER" and "CAUTION".



Procedures which may lead to a dangerous condition and cause death or serious injury if not carried out properly.



Procedures which may lead to a dangerous condition and cause superficial to medium injury, or physical damage only, if not carried out properly.

Depending on circumstances, procedures indicated by CAUTION may also be linked to serious results.

In any case, it is important to follow the directions for usage.

Store this manual in a safe place so that you can take it out and read it whenever necessary. Always forward it to the end user.

### [Design precautions]

#### DANGER

- Configure a safety circuit external to the PC, so that the entire system operates safety even if there is an external power error or if the PC is malfunctioning.

#### CAUTION

- Do not bundle, or near the control cables and communication cables with the main circuit and power cables. Keep them at least 100mm (3.94inch) away from such cables. Noise may cause malfunction.

### [Installation precautions]

#### CAUTION

- Use the PC in the environment given in the general specifications of the this manual. Using the PC outside the range of the general specifications may result in electric shock, fire or malfunctioning, or may damage or degrade the module.
- Insert the tabs at the bottom of the module into the mounting holes in the base module before installing the module, and after tightening the module fixing screws with specified torque. If the connector is not properly installed and tightened. It may result in malfunctioning, failure or cause the module to lam out.  
Tightening the screws too far may cause damage to the screw and/or the module, resulting in fall out, short circuit or malfunctions.
- Do not directly touch the module's conductive parts or electronic components. Doing so could cause malfunction or failure in the module.
- Insert the wire breakage detection connector installation screw into the mounting holes in the module, and after tightening the connector installation screw with specified toque. If the connector is not properly installed and tightened, it may result in error detetion of wire breakage.

### [Wiring precautions]

#### CAUTION

- Be sure to ground the shield wire with a special PC ground of Type III or above. Not doing so could result in malfunction.
- When wiring in the PC, be sure that it is done correctly by checking the product's rated voltage and the terminal layout. Connecting a power supply that is different from the rating or incorrectly wiring the product could result in fire or failure.
- Tighten the terminal screws with specified torque. Loose terminal screws may cause a short circuit, fire, or malfunction.  
Tightening the terminal screws too far may cause damage to the screw and/or the module, resulting in short circuit, or malfunctions.
- Be sure that cuttings, wire chips, or other foreign matter do not enter the module. Foreign matter may start a fire or cause failure or malfunctions.
- Be sure to fix communication cables and power cables leading from the module by placing them in the duct or clamping them. Cables not placed in the duct or without clamping may hang or shift, allowing them to be accidentally pulled, which may result in a module malfunction and cable damage.
- When detaching the communication cable from the module, do not pull the cable portion. For cables with connectors, hold the connector at the junction to the module, then detach it. For cables without connectors, first loosen the screw at the junction, then detach to the cable. Pulling the cable portion while it is connected to the module may cause a malfunction or damage to the module and cable.

### [Starting and maintenance precautions]

#### CAUTION

- Do not touch the terminal while the power is on.  
It may cause malfunction.
- Make sure to switch all phases of the external power supply off before cleaning or re-tightening the terminal screws. If you do not switch off the external power supply, it will cause failure or malfunction of the module.
- Never disassemble or modify the module. This may cause failure, malfunctioning, injury and/or fire.
- Make sure to switch all phases of the external power supply off before mounting or removing the module. If you do not switch off the external power supply, it will cause failure or malfunction of the module.

### [Disposal precaution]

#### CAUTION

- When disposing of this product, handle it as industrial waste.

## About This Manual

The following product manuals are available. Please use this table as a reference to request the appropriate manual as necessary.

### Detailed manual

Manual name	Manual No. (Model Code)
A1S62TCRT-S2 Heating-Cooling Temperature Control Module A1S62TCRTBW-S2 Heating-Cooling Temperature Control Module with Wire Breakage Detection Function User's Manual	SH-3644 (13JL36)

Please read A1S62TCRT-S2 Heating-Cooling Temperature Control Module  
A1S62TCRTBW-S2 Heating-Cooling Temperature Control Module with Wire Breakage Detection Function User's Manual (Detailed edition) when using this unit.

## 1. General Description

This user's manual describes the specification, name of each part, wiring, etc. of the A1S62TCRT-S2 Heating-Cooling Temperature Control Module (Hereafter abbreviated as A1S62TCRT-S2) A1S62TCRTBW-S2 Heating-Cooling Temperature Control Module with Wire Breakage Detection Function (Hereafter abbreviated as A1S62TCRTBW-S2) A1S62TCRT-S2 and A1S62TCRTBW-S2 abbreviated as A1S62TC. After unpacking, confirm that there is the following products.

Item	A1S62TCRT-S2 Main body	A1S62TCRTBW-S2 Main body
A1S62TCRT-S2	1	-
A1S62TCRTBW-S2	-	1

## 2. Performance Specification

The A1S62TC performance specification is indicated in Table 2.1.

**Table 2.1 A1S62TC performance specification**

Item	Specification	
	A1S62TCRT-S2	A1S62TCRTBW-S2
Control output	Transistor output	
Temperature input points	2-channel/module	
Supported platinum temperature-measuring resistor	Refer to Table 2.2.	
Specification accuracy	Ambient temperature: 23°C ± 5°C	Full scale × (± 0.3%) ± 1 digit*1
	Ambient temperature: 0 to 55°C	Full scale × (± 0.7%) ± 1 digit*1
Sampling period	0.5s/2-channel (It is not connected with the number of channels used)	
Heating control output period	1 to 100s	
Cooling control output period	1 to 100s	
Sensor current	0.25mA	
Allowable input wire resistor effects	Less than 20Ω	
Input filter	0 to 100s (0: input filter off)	
Sensor compensation value setting	-50.00 to 50.00%	
Operation when sensor input is disconnected	Upscale processing	
Temperature control method	PID on/off pulse	
PID constant range	PID constant setting	Auto-tuning setting is possible
	Heating proportional band (Ph)	0.1 to 1000.0%
	Cooling proportional band (Pc)	
	Integral time (I)	1 to 3600s
Derivative time (D)	0 to 3600s (0: PI control)	
Set value setting range	Within the temperature range set by the platinum temperature-measuring resistor to be used.	
Cooling method setting	Air cooling/water cooling	
Transistor output	Output signal	ON/OFF pulse
	Rated load voltage	10.2 to 30.0VDC (peak voltage : 30.0VDC)
	Maximum load current	0.1A/1 point 0.4A/common
	Maximum inrush current	0.4A 10ms
	Maximum current when OFF	Less than 0.1mA
	Maximum voltage drop when ON	1.0VDC (TYP) 0.1A 2.5VDC (MAX) 0.1A
Response time	OFF → ON: Less than 2ms ON → OFF: Less than 2ms (resistor load)	
Insulation method	Between the input and grounding: transformer insulation Between the input and channel: transformer insulation	

**Table 2.1 A1S62TC performance specification (continued)**

Item	Specification	
	A1S62TCRT-S2	A1S62TCRTBW-S2
Heater wire breakage disconnection specification	Current sensor	URD manufactured current sensor*2 CTL-12-S36-8 (0.0 to 100.0A) CTL-6-P-H (0.00 to 20.00A) (Former model, CTL-6-P is also applicable.)
	Input method	Multiplex method A/D conversion
	Number of alert delays	3 to 255
I/O occupied points	Special 32 points	
Connection terminal	20 points terminal block	
Supported cable size (mm) [inch]	0.75 to 1.5 [0.030 to 0.059]	
Supported solder-less terminal	R1.25-3, 1.25-YS3, RAV1.25-3, V1.25-YS3A	
Internal consumed current (5VDC) [A]	0.19	0.28
Weight (kg) [lb]	0.25 [0.55]	0.28 [0.62]

For the noise resistance, dielectric withstand voltage, and insulation resistance for the PC system which uses this module, refer to the power module specification found in the CPU Module User's Manual.

\*1: "± 1 digit" error depends on the input range.

For setting unit of 1°C, ± 1°C For setting unit of 0.1°C, ± 0.1°C

\*2: Only the URD International, Ltd. current sensor can be used.

Sales channels for current sensors manufactures by URD International Ltd. are listed as follows:

U.S.A.	Julia Industries Inc. Tel:949-831-0111	KOREA	Joyang Trading Co. Tel:02-521-2294
BRAZIL	Ananda Industrial Ltda. Tel:011-5584-0959		Sewon Tech Co.,Ltd. Tel:02-868-9355/9356
UNITED KINGDOM	Omni Components Tel:024-7622-5757		Keum Ho Corporation Tel:51-319-4155/4156
GERMANY	Allied Electronics GmbH Tel:0221-497-3084	HONG-KONG	Weltronics Components Ltd. Tel:2410-0623
FRANCE	Diltronic S.A. Tel:01-34-51-33-00	TAIWAN	Tope Co.,Ltd. Tel:886-2-8228-0658
ITALY	ELNET s.n.c. Tel:041-50-19-939	INDIA	AmtechElectronics PVT.Ltd. Tel:02712-25324

**Table 2.2 The types of supported platinum temperature-measuring resistor and the measured temperature range**

Platinum temperature-measuring resistor	°C		°F	
	Measured temperature range	Data resolution	Measured temperature range	Data resolution
Pt 100	-200.0 to 600.0	0.1	-300 to 1100	1
	-200.0 to 200.0		-300.0 to 300.0	0.1
JPt100	-200.0 to 500.0	0.1	-300 to 900	1
	-200.0 to 200.0		-300.0 to 300.0	0.1

For the general specifications, refer to the User's Manual for the PC CPU used.

### 3. Name of Each Part

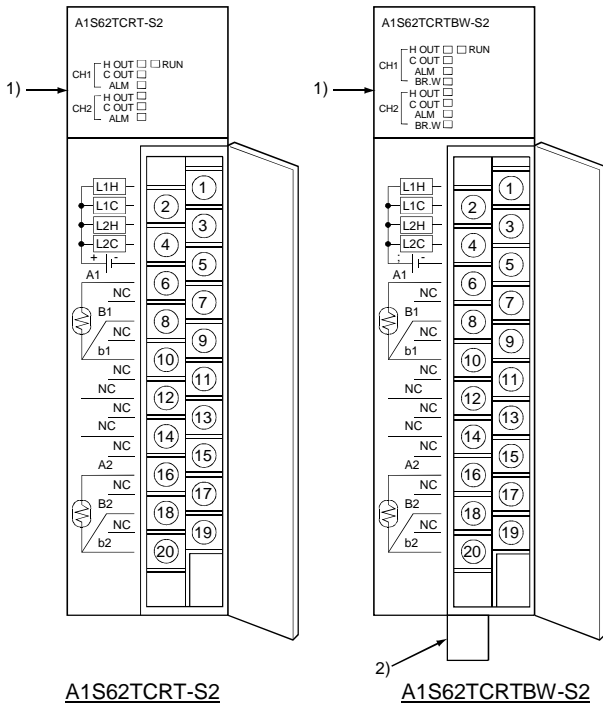

A1S62TCRT-S2

A1S62TCRTBW-S2

A1S62TCRT-S2 LED

A1S62TCRTBW-S2 LED

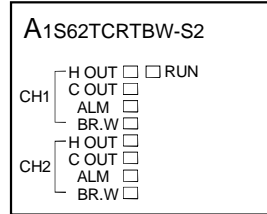
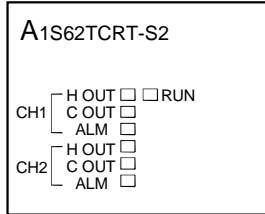

Number	Name	Description
1)	LED	RUN A1S62TC operation status display ON: Normal operation in progress Flashing (2 sec. ON/2 sec. OFF): Write data error Flashing (1 sec. ON/1 sec. OFF): Hardware error OFF: 5V power shutoff, Watchdog timer error
		OUT Transistor output status display ON: Transistor output ON OFF: Transistor output OFF
		ALM Alert alarm status display ON: Alert alarm is ON. Flashing: The measured temperature range is exceeded. The platinum temperature-measuring resistor is not connected. The platinum temperature-measuring resistor cable is disconnected. OFF: Alert alarm is OFF
		BR.W Heater wire breakage detection status display ON: Heater wire breakage is detected. OFF: Heater wire breakage is not detected.
2)	Wire breakage detection connector	Connector for current sensor  Wire breakage detection connector installation screw Cable fixing screw BW1(For CH1) BW2(For CH2) NC(Unusable)

### 4. Loading and Installation

Precautions when handling the A1S62TC and installation environment are explained.

For details of implementing and setting up this unit, please refer to the User's Manual for the PC CPU used.

#### 4.1 Handling Instructions

- 1) The module case is made of plastic. Be sure not to drop it or subject it to strong vibration.
- 2) Do not remove the module printed circuit boards from the case. It may cause trouble.
- 3) When connecting the wiring, do not allow wire cuttings or other foreign matter to enter from the top of the module. Remove any foreign matter from the module.
- 4) Tighten the module installation screws within the following tightening torque range.

Screw position	Tightening torque range
Module installation screw (M4 screw)	78 to 118N•cm
Terminal block terminal screw (M3.5 screw)	59 to 88N•
Terminal block installation screw (M4 screw)	78 to 118N•cm
Wire breakage detection connector installation screw (M2.6 screws)*	15 to 30N•cm
Cable fixing screw (M2 screws)*	11 to 14N•cm

\*:Use only for A1S62TCRTBW-S2 .

#### 4.2 Installations Environment

Never install the AnS series PC system in the following environments:

- 1) Locations where the ambient temperature is outside the range of 0 to 55°C.
- 2) Locations where the ambient humidity is outside the range of 10 to 90%RH.
- 3) Locations where dew condensation takes place due to sudden temperature changes.
- 4) Locations where there are corrosive and/or combustible gasses.
- 5) Locations where there is a high level of conductive power (such as dust and iron filings, oil mist, salt, and organic solvents).
- 6) Locations exposed to the direct rays of the sun.
- 7) Locations where strong power and magnetic fields are generated.
- 8) Locations where vibration and shock are directly transmitted to the main module.

### 5. Wiring

The precaution when wiring and the module connection example are shown below.

#### 5.1 Precaution when wiring

In order to have the best result from the A1S62TC functions and to make the system highly reliable, an external cabling with low noise effects are necessary.

The external wiring precautions are shown below:

- 1) Use separate cables for the alternating current and A1S62TC external input signals to avoid A/C surges and induction effects.
- 2) Do not bunch the cables with the main circuit, high-voltage cable or load cables from other than PC, or install them close to each other.  
Install the cables far apart from high-frequency circuits, such as the high-voltage cable and inverter load main circuit, as much as possible.  
This increases the noises, surges, and induction.
- 3) Perform a one-point grounding for the shielded line and shields of the seal and cable at the PC. However, there may be cases when grounding should be performed externally depending on the noise condition.

## 5.2 Module connection example

### 1) A1S62TCRT-S2

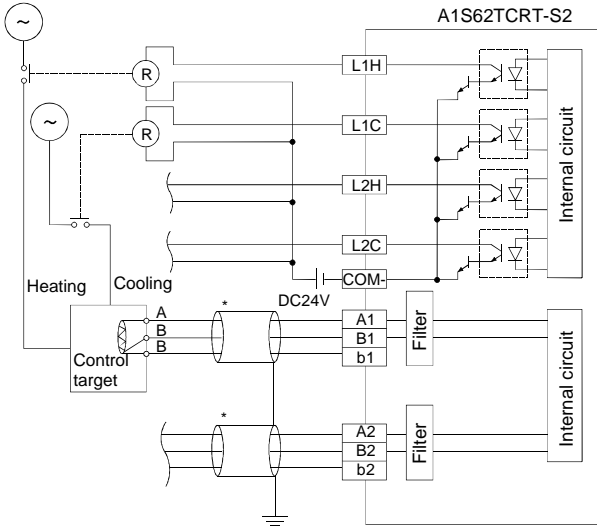

\*1: Please use the cable with shield.

### 2) A1S62TCRTBW-S2

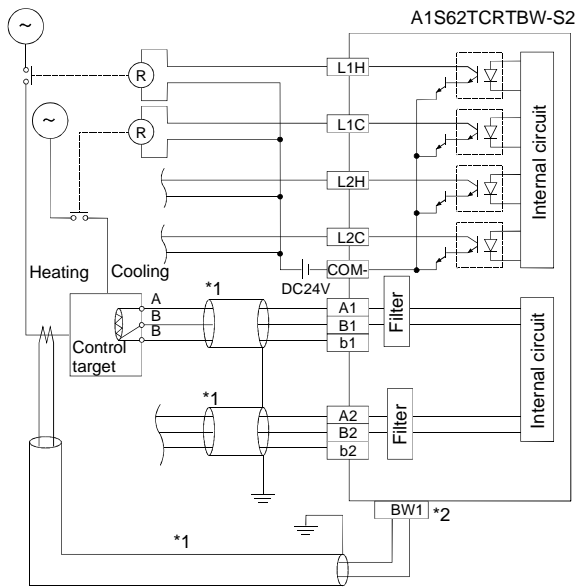

\*1: Please use the cable with shield.

\*2: Refer to the following for the connection of the wire breakage detection connector.

Cable with shield

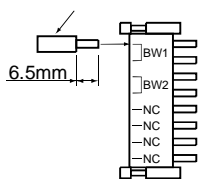

[Connect to]

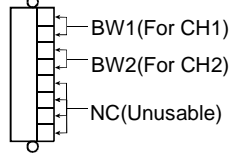

## 6. External Dimensions

### 6.1 A1S62TCRT-S2

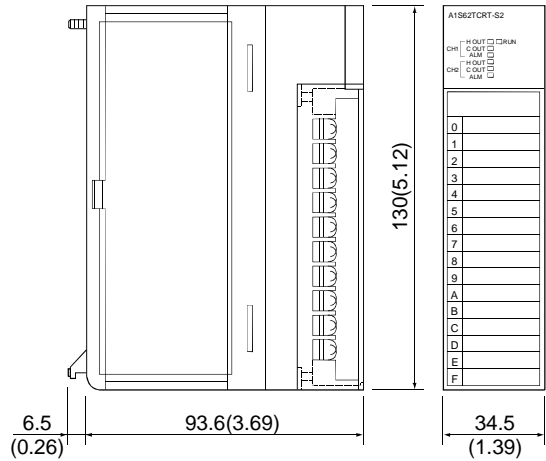

### 6.2 A1S62TCRTBW-S2

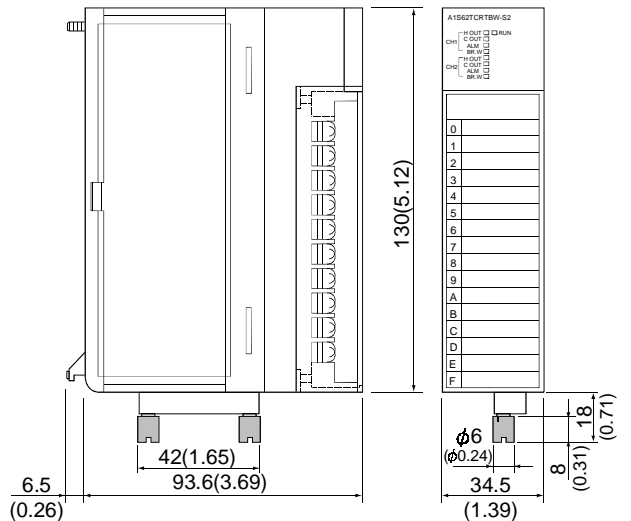

Unit : mm(inch)

### Warranty

Mitsubishi will not be held liable for damage caused by factors found not to be the cause of Mitsubishi; machine damage or lost profits caused by faults in the Mitsubishi products; damage, secondary damage, accident compensation caused by special factors unpredictable by Mitsubishi; damages to products other than Mitsubishi products; and to other duties.

⚠ For safe use

- This product has been manufactured as a general-purpose part for general industries, and has not been designed or manufactured to be incorporated in a device or system used in purposes related to human life.
- Before using the product for special purposes such as nuclear power, electric power, aerospace, medicine or passenger movement vehicles, consult with Mitsubishi.
- This product has been manufactured under strict quality control. However, when installing the product where major accidents or losses could occur if the product fails, install appropriate backup or failsafe functions in the system.

Country/Region	Sales office/Tel	Country/Region	Sales office/Tel
U.S.A	Mitsubishi Electric Automation Inc. 500 Corporate Woods Parkway Vernon Hills, IL 60061 Tel : +1-847-478-2100	China	Ryoden International Shanghai Ltd. 3F Block5 Building Automation Instrumentation Plaza 103 Cao Bao Rd. Shanghai 200233 China Tel : +86-21-6475-3228
Brazil	MELCO-TEC Rep. Com.e Assessoria Tecnica Ltda. Av. Rio Branco, 123-15 and S/1507, Rio de Janeiro, RJ CEP 20040-005, Brazil Tel : +55-21-221-8343	Taiwan	Setsuyo Enterprise Co., Ltd. 6F., No.105 Wu-Kung 3rd.RD, Wu-Ku Hsiang, Taipei Hsiang, Taiwan Tel : +886-2-2299-2499
Germany	Mitsubishi Electric Europe B.V. German Branch Gothaer Strasse 8 D-40880 Ratingen, GERMANY Tel : +49-2102-486-0	Korea	HAN NEUNG TECHNO CO.,LTD. 1F Dong Seo Game Channel Bldg., 660-11, Deungchon-dong Kangsec-ku, Seoul, Korea Tel : +82-2-3660-9552
U.K	Mitsubishi Electric Europe B.V. UK Branch Travellers Lane, Hatfield, Herts., AL10 8XB,UK Tel : +44-1707-276100	Singapore	Mitsubishi Electric Asia Pte. Ltd. 307 ALEXANDRA ROAD #05-01/02, MITSUBISHI ELECTRIC BUILDING SINGAPORE 159943 Tel : +65-473-2480
Italy	Mitsubishi Electric Europe B.V. Italian Branch Centro Dir. Colleoni, Pal. Perseo - Ingr.2 Via Paracelso 12, 20041 Agrate B., Milano, Italy Tel:+39-039-60531	Thailand	F. A. Tech Co.,Ltd. 898/28,29,30 S.V.City Building,Office Tower 2,Floor 17-18 Rama 3 Road, Bangpoo, Yamaawa, Bangkok 10120 Tel : +66-2-682-6522
Spain	Mitsubishi Electric Europe B.V. Spanish Branch Carretera de Rubi 76-80 08190 - Sant Cugat del Valles, Barcelona, Spain Tel:+34-935-653135	Indonesia	P.T. Autoteknindo SUMBER MAKMUR Jl. Muara Karang Selatan Block A Utara No.1 Kav. No.11 Kawasan Industri/Perdagangan Jakarta - Utara 14440 Tel : +62-21-663-9833
South Africa	Circuit Breaker Industries LTD. Private Bag 2016, Isando 1600, Johannesburg, South Africa Tel : +27-11-928-2000	India	Messung Systems Pvt.Ltd. Electronic Sadan NO:111 Unit No15, M.I.D.C BHOSARI,PUNE-411026 Tel : +91-20-7128927
Hong Kong	Ryoden Automation Ltd. 10th Floor, Manulife Tower, 169 Electric Road, North Point, HongKong Tel : +852-2687-8870	Australia	Mitsubishi Electric Australia Pty. Ltd. 348 Victoria Road, PostalBag, No 2, Rydalmere, N.S.W 2116, Australia Tel : +61-2-9684-7777

**MITSUBISHI ELECTRIC CORPORATION**

HEAD OFFICE : 1-8-12, OFFICE TOWER 2 14F HARUMI CHUOKU 104-6212, JAPAN  
NAGOYA WORKS : 1-14, YADA-MINAMI, HIGASHI-KU, NAGOYA, JAPAN

When exported from Japan, this manual does not require application to the Ministry of Economy, Trade and Industry for service transaction permission.

Specifications subject to change without notice.  
Printed in Japan on recycled paper.