

MITSUBISHI Pt100 Input Module

User's Manual (Hardware) A1S62RD3/4

Thank you for buying the Mitsubishi general-purpose programmable logic controller MELSEC-A Series

Prior to use, please read both this manual and detailed manual thoroughly and familiarize yourself with the product



MODEL	A1S62RD3/4(H/W)-U-E
MODEL CODE	13JE44
IB(NA)-66483-B(0002)MEE	

©1994 MITSUBISHI ELECTRIC CORPORATION

● SAFETY PRECAUTIONS ●

(Read these precautions before using)

When using Mitsubishi equipment, thoroughly read this manual and the associated manuals introduced in this manual. Also pay careful attention to safety and handle the module properly.

These precautions apply only to Mitsubishi equipment. Refer to the CPU module user's manual for a description of the PC system safety precautions.



Procedures which may lead to a dangerous condition and cause death or serious injury if not carried out properly.



Procedures which may lead to a dangerous condition and cause superficial to medium injury, or physical damage only if not carried out properly.

Depending on circumstances, procedures indicated by **CAUTION** may also be linked to serious results.

In many cases, it is important to follow the directions for usage.

Store this manual in a safe place so that you can take it out and read it whenever necessary.

Always forward it to the end user.

[SYSTEM DESIGN PRECAUTIONS]

CAUTION

- Do not bundle control lines or communication wires together with main circuit or power lines, or lay them close to these lines. As a guide, separate the lines by a distance of at least 100mm, otherwise malfunctions may occur due to noise.

[CAUTIONS ON MOUNTING]

CAUTION

- Use the PC in an environment that conforms to the general specifications in the manual. Using the PC in environments outside the ranges stated in the general specifications will cause electric shock, fire, malfunction, or damage to/deterioration of the product.
- Install so that the pegs on the bottom of the unit fit securely into the base unit peg holes. Not installing the unit correctly could result in erroneous operation, damage, or pieces of the product falling.

[CAUTIONS ON WIRING]

CAUTION

- Be sure to ground the FG and LG terminals, carrying out at least class 3 grounding work with a ground exclusive to the PC. Otherwise there will be a danger of electric shock and malfunctions.
- Carry out wiring to the PC correctly, checking the rated voltage and terminal arrangement of the product. Using a power supply that does not conform to the rated voltage, or carrying out wiring incorrectly, will cause fire or failure.
- Tighten the terminal screws to the stipulated torque. Loose screws will cause short circuits, fire, or malfunctions.
- Make sure that no foreign matter such as chips or wiring offcuts gets inside the module. It will cause fire, failure or malfunction.

[CAUTIONS ON STARTUP AND MAINTENANCE]

⚠ DANGER

- Do not touch terminals while the power is ON. This will cause malfunctions.
- Switch the power off externally for all phases before cleaning or re-tightening terminal screws, otherwise you may sustain electric shock.

CAUTION

- Do not disassemble or modify any module. This will cause failure, malfunction, injuries, or fire.
- Turn the power off when removing a unit. Trying to remove the unit while the power is on could damage the unit or result in erroneous operation.

[CAUTIONS ON DISPOSAL]

CAUTION

- Dispose of this product as industrial waste.

About the Manuals

The following product manuals are available. Please use this table as a reference to request the appropriate manual as necessary.

Detailed Manual

Manual name	Manual No (Model code)
Pt100 input module type A1S62RD3/4 User's Manual	IB-66338 (13J675)

1. Overview

This manual describes the specifications and names of the parts of the platinum resistance bulb Pt100 temperature input module A1S62RD3 and platinum resistance bulb Pt100 temperature input module A1S62RD4 (hereinafter, A1S62RD3/4) used with the MELSEC-A Series PLC CPU

2. Performance Specifications

2.1 Performance specifications

The performance specifications of the A1S62RD3/4 are shown below.

Item	A1S62RD3	A1S62RD4
Measurement method	3-wire type	4-wire type
Connectable resistance bulb	Pt100 (JIS C1604-1989, DIN 43760 1980 compatible) JPT100 (JIS C1604 1989 compatible)	
Temperature detection output current	4.2mA (MIN.) 4.7mA (MAX.)	
Temperature input range	Pt100: 180[°C] to +600[°C] (27.08Ω to 313.59Ω) JPT100: -180[°C] to +600[°C] (25.8Ω to 317.28Ω)	
Temperature detection value	16-bit signed binary: -1800 to +6000 (value to first decimal digit x 10 fold)	
	32-bit signed binary: -180000 to +600000 (value to third decimal digit x 1000-fold)	
	0.025[°C]	
Resolution	±1% (precision in respect to full scale)	
General precision	40ms/channel	
Conversion speed	2 channels/module	
No. of temperature input points	Between channels: Not insulated Between input terminal and PLC power supply: Photo coupler insulation	
Insulation method	32 points	
No. of occupied input/output points	20-point terminal block	
Connected terminal block	0.75 to 1.5mm ²	
Applicable wire size	Refer to section 2.2	
Cable between A1S62RD and Pt100	V1.25-3, V1.25-YS3A, V2-53, V2-YS3A	
Applicable crimp terminal	0.54A	0.44A
Internal current consumption (5VDC)	0.29kg	0.28kg
Weight		

Refer to the PLC CPU User's Manual for the general specifications

3. Names of Each Part and Settings

3.1 Names of each part

The names of each part of the A1S62RD3/4 are explained below

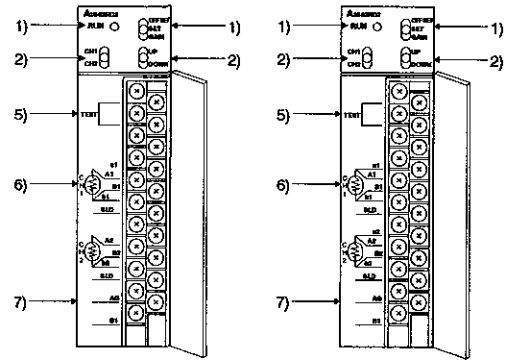

No.	Name	Details				
1)	Operation status display LED (RUN LED)	<table border="1"> <tr> <td>Normal mode</td> <td>ON : In normal operation ON : Write data error occurring OFF : 5VDC power OFF or watch dog timer error occurring</td> </tr> <tr> <td>Test mode</td> <td>Flicker : When the OFFSET/GAIN setting switch is set to OFFSET or GAIN, the LED will flicker at 0.5 second intervals OFF : OFFSET/GAIN setting switch set to SET.</td> </tr> </table>	Normal mode	ON : In normal operation ON : Write data error occurring OFF : 5VDC power OFF or watch dog timer error occurring	Test mode	Flicker : When the OFFSET/GAIN setting switch is set to OFFSET or GAIN, the LED will flicker at 0.5 second intervals OFF : OFFSET/GAIN setting switch set to SET.
Normal mode	ON : In normal operation ON : Write data error occurring OFF : 5VDC power OFF or watch dog timer error occurring					
Test mode	Flicker : When the OFFSET/GAIN setting switch is set to OFFSET or GAIN, the LED will flicker at 0.5 second intervals OFF : OFFSET/GAIN setting switch set to SET.					
2)	Channel selection switch	Selects the channel for adjusting the offset and gain for error compensation.				
3)	OFFSET/GAIN setting switch	Sets the offset value and gain value for the test mode 1) OFFSET position : Offset value compensation mode 2) GAIN position : Gain value compensation mode 3) SET position : Offset value/gain value save mode The temperature detection value at the time the switch is changed from the OFFSET/GAIN position to the SET position is saved in the A1S62RD3/4 internal memory as the offset/gain value.				
4)	UP/DOWN switch	Increments/decrements the offset value/gain value for the channel being used at the following rate 1) ON for less than 1.5 seconds: Increments/decrements in 0.025-°C units 2) ON for 1.5 seconds or more: Increments/decrements in 0.1-°C unit every 0.04 seconds.				
5)	Test mode terminal	Short-circuit across terminals 1 and 3 to carry out error compensation.				
6)	Pt100 connection terminal	Connect the Pt100 (Refer to section 5)				
7)	Analog/ground terminal	Use to provide a separate ground				

2.2 Specifications when platinum resistance bulb is connected

The specifications for connecting the A1S62RD3/4 with the platinum resistance bulb are explained below

1) For A1S62RD3

Make sure that the conductor resistance value between the Pt100 and A1S62RD3 is **10 [Ω] or less** per wire
All channels between CH 1 and CH 2 have the same specifications

CH 1 to CH 2

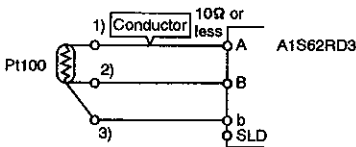

Wire so that the following is satisfied:
1) Conductor resistance value ≤ 10 (Ω)
2) Conductor resistance value ≤ 10 (Ω)
3) Conductor resistance value ≤ 10 (Ω)

2) For A1S62RD4

Make sure that the total resistance value of the conductors over which the current passes is **70 [Ω] or less**

[Example] To connect Pt100 to both CH 1 and CH 2

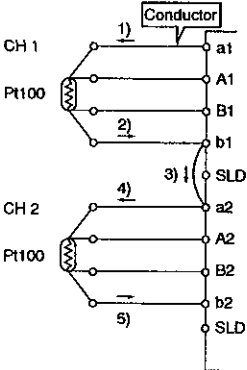

Wire so that $1) + 2) + 3) + 4) + 5) \leq 70$ (Ω)

The arrow → indicates the current flow

3.2 Error compensation procedures

The flow for error compensation is shown below

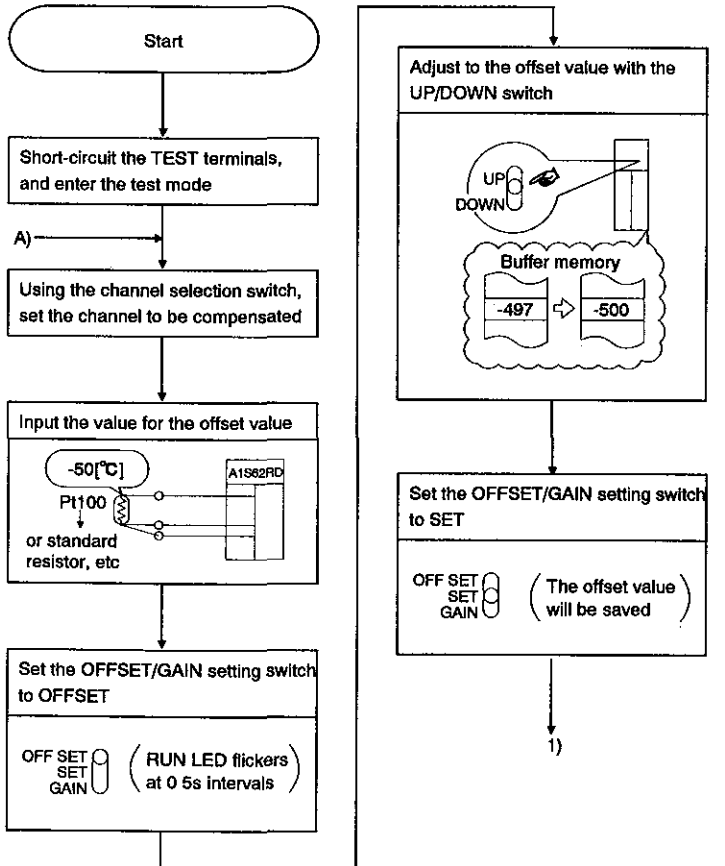

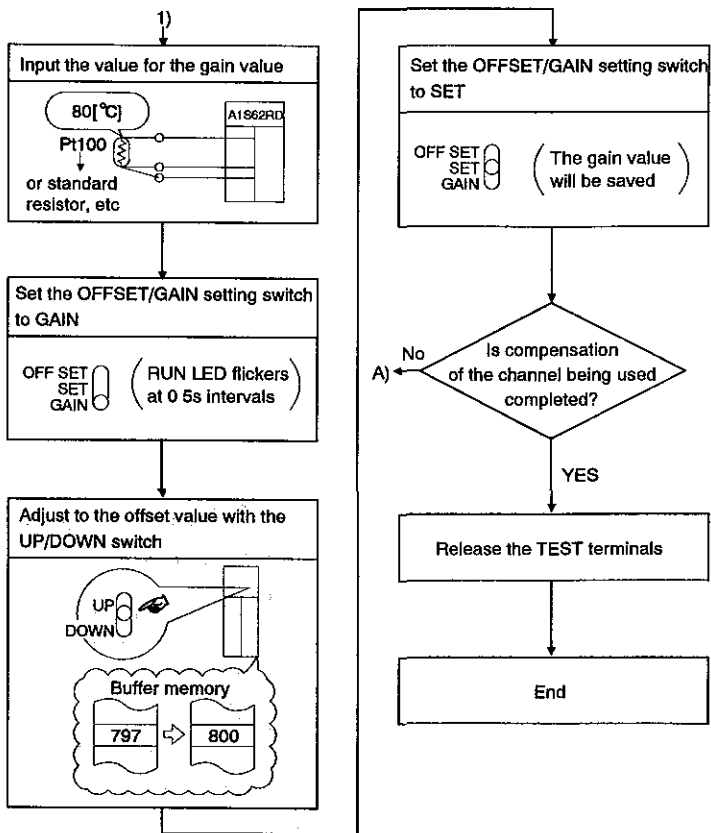

POINT

- Once the offset/gain is set with the test mode, the offset value cannot be checked by setting the OFFSET/GAIN setting switch to OFFSET again. (The setting value is held.)
- If the device is used in the normal mode after the offset/gain is set with the test mode, the previously set offset value and gain value cannot be confirmed by entering the test mode. (The setting value is held.)

5 2 Connection to A1S62RD3

1) The highest precision can be achieved by connecting a 3-wire type Pt100 to the A1S62RD3. An example of connecting a 3-wire Pt100 is shown below.

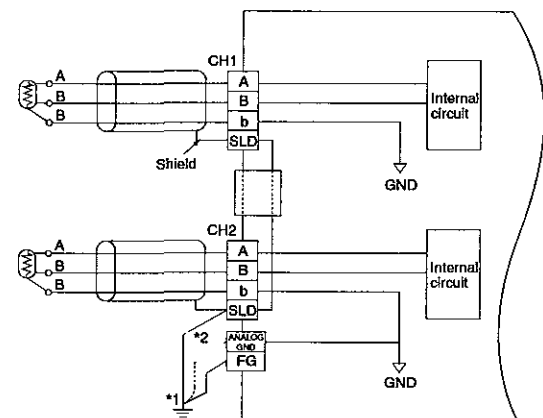

*1 Also ground the power supply unit's FG
 *2 It may be preferable to connect this depending on the working environment
 2) A 4-wire type or 2-wire type Pt100 can also be used with the A1S62RD3. Connect as shown below when connecting a 4-wire type or 2-wire type Pt100.

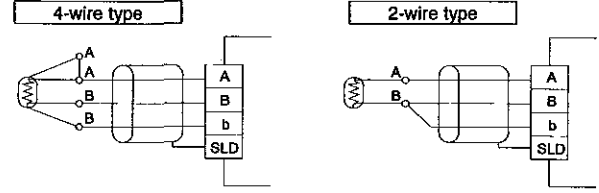

4. Handling

4 1 Precautions for handling

- The main case and terminal block are made of resin, so do not drop it or apply strong impacts.
- Do not remove the module's PCB from the case. Failure to observe this could lead to faults.
- Make sure that foreign matter, such as wire scraps, do not enter the module during wiring. Remove any foreign matter that enters.
- Tighten the module installation screws and terminal screws within the following ranges.

Screw position	Tightening torque range
Module installation screw (M4 screw)	78 to 118N•cm {8 to 12kg•cm}
Terminal block installation screw (M3.5 screw)	59 to 88N•cm {6 to 9kg•cm}
Terminal block terminal screw (M4 screw)	78 to 118N•cm {8 to 12kg•cm}

5. Wiring

Precautions for connecting the Pt100 to the A1S62RD3/4, and the connection methods are described below.

5 1 Precautions for connecting

As a condition to use the A1S62RD functions to the fullest and create a highly reliable system, external wiring that is not susceptible to noise is required. The precautions for external wiring are shown below.

- Use separate cables for the AC and A1S62RD external input signal, and make sure that the cable is not affected by the AC side surge or inductance.
- Do not lay the cables near or with the main circuit wires, high-voltage wires or load wires other than those from the PLC. Failure to observe this will increase the effect of noise, surge and inductance.
- Ground the shield wire or shield clamp shield to one point on the PLC side. Note that in some cases, grounding these at an external source may be preferable depending on the state of the external noise.

5 3 Connection to A1S62RD4 and precautions

1) The highest precision can be achieved by connecting a 4-wire type Pt100 to the A1S62RD4. An example of connecting a 4-wire Pt100 is shown below.

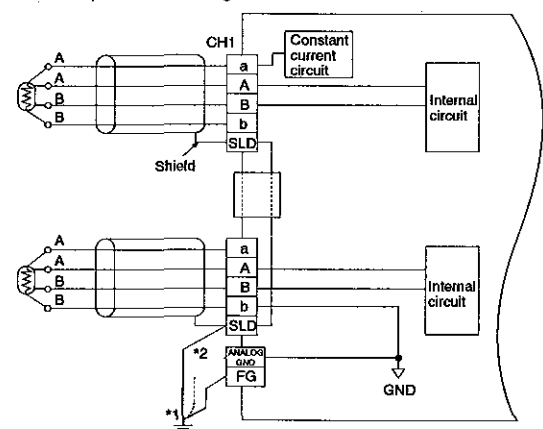

*1 Also ground the power supply unit's FG
 *2 It may be preferable to connect this depending on the working environment
 2) A 3-wire type or 2-wire type Pt100 can also be used with the A1S62RD4. Connect as shown below when connecting a 3-wire type or 2-wire type Pt100.

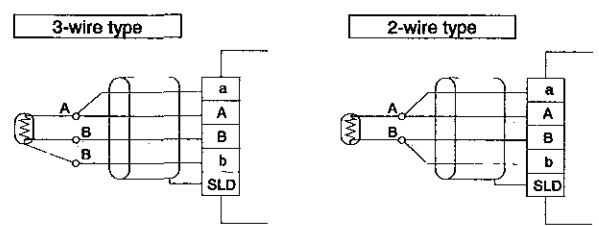

Precautions for connecting to A1S62RD4

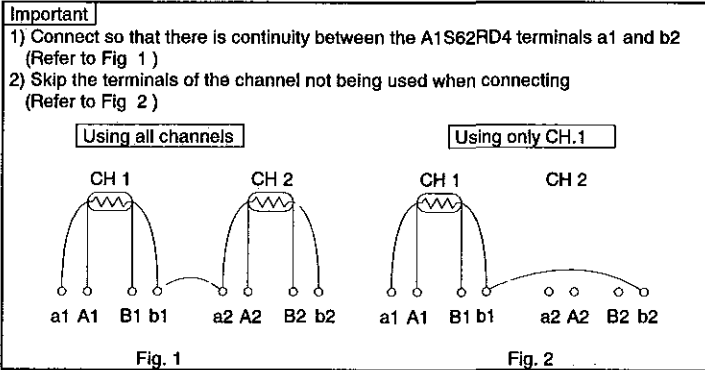

Point

Always designate the channel to which the Pt100 is not connected as "Conversion Prohibited"

When the channel to which the Pt100 is not connected are designated as "Conversion Enabled", the disconnection detection flag turns ON even if the channel to which the Pt100 is connected is not disconnected.

6. Outline Dimension Drawing

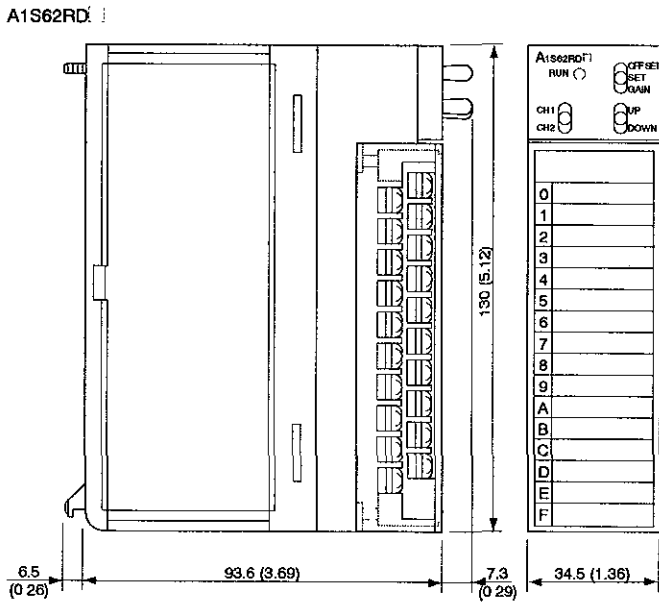

Warranty

Mitsubishi will not be held liable for damage caused by factors found not to be the cause of Mitsubishi; machine damage or lost profits caused by faults in the Mitsubishi products; damage, secondary damage, accident compensation caused by special factors unpredictable by Mitsubishi; damages to products other than Mitsubishi products; and to other duties

▲ For safe use

- This product has been manufactured as a general-purpose part for general industries, and has not been designed or manufactured to be incorporated in a device or system used in purposes related to human life
- Before using the product for special purposes such as nuclear power, electric power, aerospace, medicine or passenger movement vehicles, consult with Mitsubishi
- This product has been manufactured under strict quality control However, when installing the product where major accidents or losses could occur if the product fails, install appropriate backup or failsafe functions in the system

Country/Region	Sales office/Tel	Country/Region	Sales office/Tel
U.S.A.	Mitsubishi Electric Automation Inc. 500 Corporate Woods Parkway Vernon Hills IL 60061 Tel : 1-847-478-2100	Taiwan	Selsuyo Enterprise Co., Ltd 6F No 105 Wu Kung 3rd RD, Wu Ku Hsiang Taipei Hsine, Taiwan R.O.C Tel : 886-2-2299-2499
Brazil	MELCO-TEC Rep Com e Assessoria Tecnica Ltda Av Rio Branco 123-15 and S/1507 Rio de Janeiro RJ CEP 20040-005 Brazil Tel : 55 21-221-8343	Korea	STC Techno Seouf Co Ltd 1F Dong Seo Game Channel Bldg 660-11, Daengchon-dong Kangseok-ku Seouf, Korea Tel : 82 2-3668-6567
Germany	Mitsubishi Electric Europe B.V German Branch Gothar Strasse 8 D-40880 Ratingen GERMANY Tel : 49-2102 486-0	Singapore	Mitsubishi Electric Asia Pte, Ltd. 307 ALEXANDRA ROAD #05-01/02 MITSUBISHI ELECTRIC BUILDING SINGAPORE 159843 Tel : 65-475-2480
UK	Mitsubishi Electric Europe B.V UK Branch Travellers Lane Hatfield Herts AL10 8XB UK Tel : 44 1707 276100	Thailand	F.A. Tech Co Ltd 1138/33-34 Rama 9 Road Yannawa Bangkok 10120 Thailand Tel : 66-2-295-2861
South Africa	MSA Manufacturing (Pty) Ltd P.O. Box 39738 Bramley 201 8 Johannesburg South Africa Tel : 27 11-444-9080	Indonesia	P.T. Autotekindo SUMBER MAXMUR Kompleks Agung Sedayu Propertindo (Harco Mangga Dua) Blok H No 4 Jl Mangga Dua Raya Jakarta Pusat 10730-Indonesia Tel : 62 21-5392592
Hong Kong	Ryoden International Ltd 10th Floor, Manulife Tower 169 Electric Road, North Point, HongKong Tel : 852-2887-8970	India	Messung Systems Pvt Ltd. Electronic Sedan NO:111 Unit No15 MID C BHOSARU,PUNE-411028 Tel : 91-20 7128927
China	Ryoden International Shanghai Ltd 3F Block5 Building Automation Instrumentation Plaza 103 Cao Bao Rd Shanghai 200233 China Tel : 86-21-6475-3228	Australia	Mitsubishi Electric Australia Pty Ltd 348 Victoria Road PostalBag, No 2 Rydalmere, N S W 2116 Australia Tel : 61-2-9684-7777

MITSUBISHI ELECTRIC CORPORATION
 HEAD OFFICE: MITSUBISHI DENKO BLDG MARUNOUCHI TOKYO 100-8116 TEL: 81-3-6634-2000 FAX: 81-3-6634-2001
 TOKYO WORKS: 1-14 YAMAGUCHI 5, HIGASHI-KU, NAGATYA, JAPAN

When exported from Japan this manual does not require application to the Ministry of International Trade and Industry for service transaction permission

Specifications subject to change without notice
 Printed in Japan on recycled paper